

FCC Test Report

Applicant : **D2G Group LLC**

Address : **81 Commerce Drive, Fall River,
Massachusetts, America**

Product Name : **55inch Edgelit Touch Floor Stand**

Report Date : **Jun. 05, 2023**

Shenzhen Anbotek Compliance Laboratory Limited



Contents

| | |
|--|----|
| 1. General Information | 6 |
| 1.1. Client Information | 6 |
| 1.2. Description of Device (EUT) | 6 |
| 1.3. Auxiliary Equipment Used During Test | 7 |
| 1.4. Description of Test Configuration | 7 |
| 1.5. Description Of Test Setup | 8 |
| 1.6. Test Equipment List | 9 |
| 1.7. Measurement Uncertainty | 10 |
| 1.8. Description of Test Facility | 10 |
| 2. Summary of Test Results | 11 |
| 3. Conducted Emission Test | 12 |
| 3.1. Test Standard and Limit | 12 |
| 3.2. Test Setup | 12 |
| 3.3. Test Procedure | 12 |
| 3.4. Test Data | 13 |
| 4. Radiation Spurious Emission and Band Edge | 16 |
| 4.1. Test Standard and Limit | 16 |
| 4.2. Test Setup | 16 |
| 4.3. Test Procedure | 17 |
| 4.4. Test Data | 18 |
| 5. Maximum Peak Output Power Test | 26 |
| 5.1. Test Standard and Limit | 26 |
| 5.2. Test Setup | 26 |
| 5.3. Test Procedure | 26 |
| 5.4. Test Data | 26 |
| 6. 6dB Occupy Bandwidth Test | 27 |
| 6.1. Test Standard and Limit | 27 |
| 6.2. Test Setup | 27 |
| 6.3. Test Procedure | 27 |
| 6.4. Test Data | 27 |
| 7. Power Spectral Density Test | 28 |
| 7.1. Test Standard and Limit | 28 |
| 7.2. Test Setup | 28 |
| 7.3. Test Procedure | 28 |
| 7.4. Test Data | 28 |
| 8. 100kHz Bandwidth of Frequency Band Edge Requirement | 29 |
| 8.1. Test Standard and Limit | 29 |



| | |
|---|----|
| 8.2. Test Setup | 29 |
| 8.3. Test Procedure | 29 |
| 8.4. Test Data | 29 |
| 9. Antenna Requirement | 30 |
| 9.1. Test Standard and Requirement | 30 |
| 9.2. Antenna Connected Construction | 30 |
| APPENDIX I -- TEST SETUP PHOTOGRAPH | 31 |
| APPENDIX II -- EXTERNAL PHOTOGRAPH | 31 |
| APPENDIX III -- INTERNAL PHOTOGRAPH | 31 |



TEST REPORT

Applicant : D2G Group LLC
Manufacturer : Shenzhen I-Pivot Intelligent Technology Co., Ltd
Product Name : 55inch Edgelit Touch Floor Stand
Model No. : DF055TLWE
Trade Mark : Displays2go
Rating(s) : Input: AC 100-240V, 50/60Hz
Test Standard(s) : FCC Part15 Subpart C, Section 15.247
Test Method(s) : ANSI C63.10: 2020, KDB 558074 D01 15.247 Meas Guidance v05r02

The device described above is tested by Shenzhen Anbotek Compliance Laboratory Limited to determine the maximum emission levels emanating from the device and the severe levels of the device can endure and its performance criterion. The measurement results are contained in this test report and Shenzhen Anbotek Compliance Laboratory Limited is assumed full of responsibility for the accuracy and completeness of these measurements. Also, this report shows that the EUT (Equipment Under Test) is technically compliant with the FCC Part 15 Subpart C requirements.

This report applies to above tested sample only and shall not be reproduced in part without written approval of Shenzhen Anbotek Compliance Laboratory Limited.

Date of Receipt

May 06, 2023

Date of Test

May 06 ~ 22, 2023

Prepared By



(TuTu Hong)

Approved & Authorized Signer



(Kingkong Jin)



Revision History

| Report Version | Description | Issued Date |
|----------------|-----------------|---------------|
| R00 | Original Issue. | Jun. 05, 2023 |
| | | |
| | | |



1. General Information

1.1. Client Information

| | | |
|--------------|---|---|
| Applicant | : | D2G Group LLC |
| Address | : | 81 Commerce Drive, Fall River, Massachusetts, America |
| Manufacturer | : | Shenzhen I-Pivot Intelligent Technology Co., Ltd |
| Address | : | 2nd Floor, Building 2A, Dacheng Industrial Zone, No. 357 Jihua Rd, Longgang District, Shenzhen, Guangdong, China |
| Factory | : | Shenzhen I-Pivot Intelligent Technology Co., Ltd |
| Address | : | 2nd Floor, Building 2A, Dacheng Industrial Zone, No. 357 Jihua Rd, Longgang District, Shenzhen, Guangdong, China |

1.2. Description of Device (EUT)

| | | |
|---|---|--|
| Product Name | : | 55inch Edgelit Touch Floor Stand |
| Model No. | : | DF055TLWE |
| Trade Mark | : | Displays2go |
| Test Power Supply | : | AC 120V, 60Hz |
| Test Sample No. | : | 1-2-1(Normal Sample), 1-2-2(Engineering Sample) |
| Adapter | : | N/A |
| RF Specification | | |
| Operation Mode | : | <input checked="" type="checkbox"/> BT BLE |
| Support Rate | : | <input checked="" type="checkbox"/> 1Mbps <input type="checkbox"/> 2Mbps |
| Operation Frequency | : | 2402~2480MHz |
| Number of Channel | : | 40 Channels |
| Modulation Type | : | GFSK |
| Antenna Type | : | External Antenna |
| Antenna Gain(Peak) | : | 5.09dBi (Provided by customer) |
| Remark: 1) For a more detailed features description, please refer to the manufacturer's specifications or the User's Manual. | | |



1.3. Auxiliary Equipment Used During Test

| Description | Rating(s) |
|-------------|-----------|
| -- | -- |

1.4. Description of Test Configuration

| Channel | Freq. (MHz) | Channel | Freq. (MHz) | Channel | Freq. (MHz) | Channel | Freq. (MHz) | Channel | Freq. (MHz) |
|-----------|-------------|---------|-------------|-----------|-------------|---------|-------------|-----------|-------------|
| 00 | 2402 | 09 | 2420 | 18 | 2438 | 27 | 2456 | 36 | 2474 |
| 01 | 2404 | 10 | 2422 | 19 | 2440 | 28 | 2458 | 37 | 2476 |
| 02 | 2406 | 11 | 2424 | 20 | 2442 | 29 | 2460 | 38 | 2478 |
| 03 | 2408 | 12 | 2426 | 21 | 2444 | 30 | 2462 | 39 | 2480 |
| 04 | 2410 | 13 | 2428 | 22 | 2446 | 31 | 2464 | | |
| 05 | 2412 | 14 | 2430 | 23 | 2448 | 32 | 2466 | | |
| 06 | 2414 | 15 | 2432 | 24 | 2450 | 33 | 2468 | | |
| 07 | 2416 | 16 | 2434 | 25 | 2452 | 34 | 2470 | | |
| 08 | 2418 | 17 | 2436 | 26 | 2454 | 35 | 2472 | | |

Note:

1. The engineering test program was provided and the EUT was programmed to be in continuously transmitting mode.
2. EUT was tested with channel 0, 19 and 39.



1.5. Description Of Test Setup

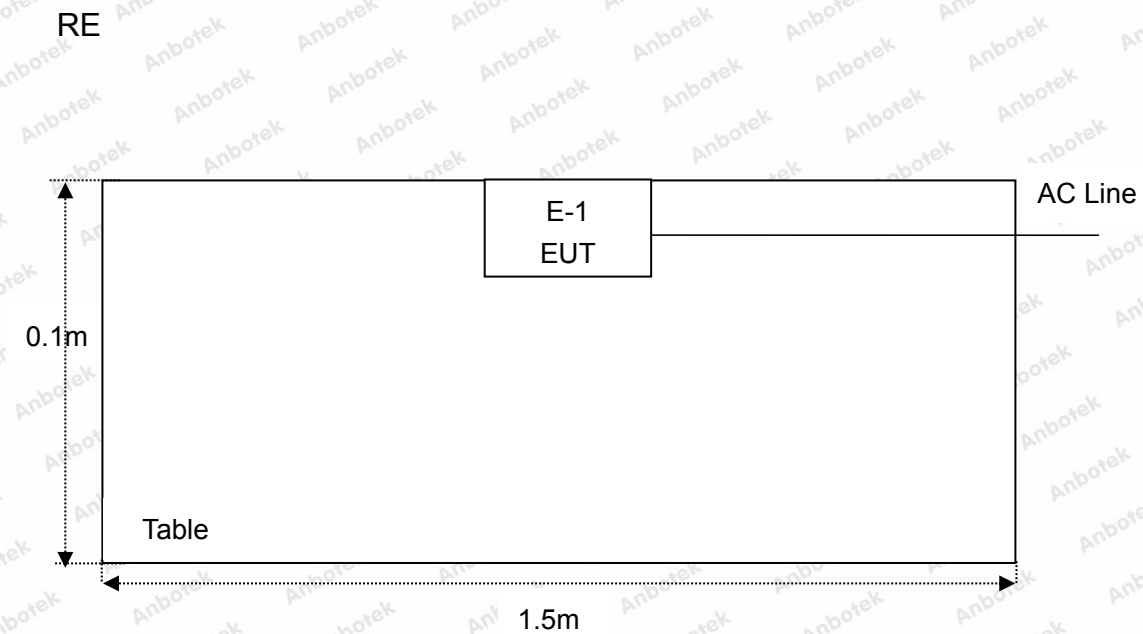
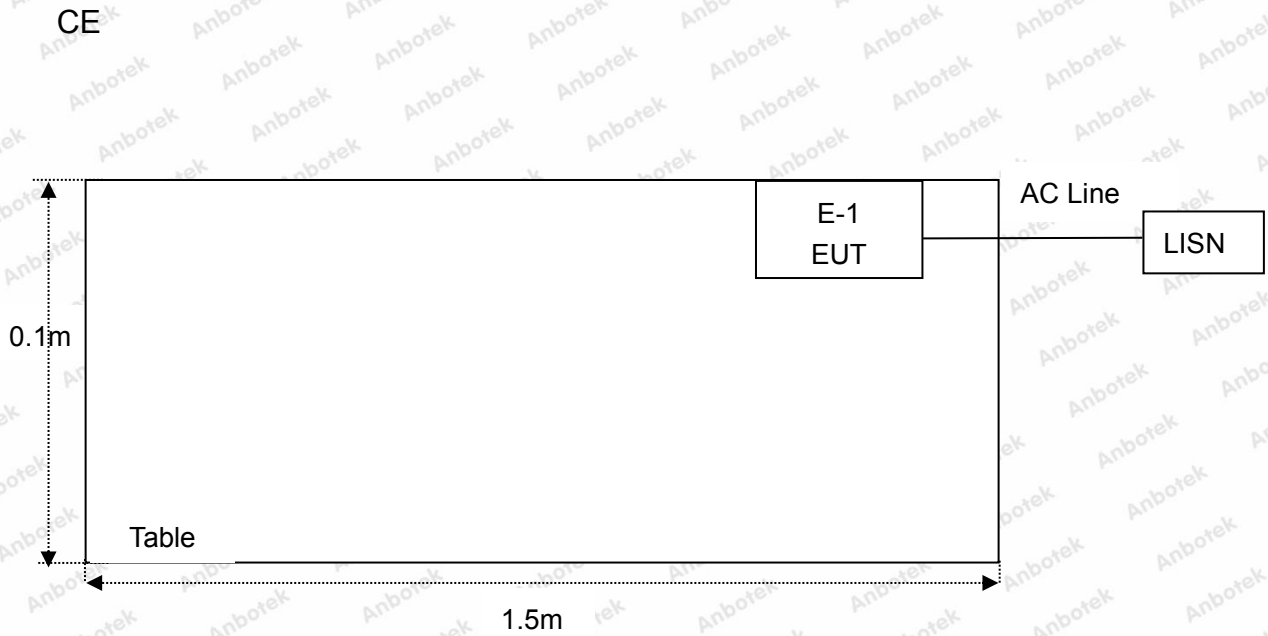

1.6. Test Equipment List

| Item | Equipment | Manufacturer | Model No. | Serial No. | Last Cal. | Cal. Interval |
|------|---|-------------------------|---------------|---------------|---------------|---------------|
| 1. | L.I.S.N. Artificial Mains Network | Rohde & Schwarz | ENV216 | 100055 | Oct. 23, 2022 | 1 Year |
| 2. | Three Phase V-type Artificial Power Network | CYBERTEK | EM5040DT | E215040DT001 | Jul. 05, 2022 | 1 Year |
| 3. | EMI Test Receiver | Rohde & Schwarz | ESCI | 100627 | Oct. 13, 2022 | 1 Year |
| 4. | EMI Test Receiver | Rohde & Schwarz | ESR26 | 101481 | Oct. 23, 2022 | 1 Year |
| 5. | RF Switching Unit | Compliance Direction | RSU-M2 | 38303 | Oct. 22, 2022 | 1 Year |
| 6. | MXA Spectrum Analysis | Agilent | N9020A | MY51170037 | Oct. 13, 2022 | 1 Year |
| 7. | EMI Preamplifier | SKET Electronic | LNPA-0118G-45 | SKET-PA-002 | Oct. 13, 2022 | 1 Year |
| 8. | Double Ridged Horn Antenna | SCHWARZBECK | BBHA 9120D | 02555 | Oct. 16, 2022 | 3 Year |
| 9. | Bilog Broadband Antenna | Schwarzbeck | VULB9163 | VULB 9163-289 | Oct. 23, 2022 | 1 Year |
| 10. | Loop Antenna | Schwarzbeck | FMZB1519B | 00053 | Oct. 23, 2022 | 1 Year |
| 11. | Horn Antenna | A-INFO | LB-180400-KF | J211060628 | Oct. 23, 2022 | 1 Year |
| 12. | Pre-amplifier | SONOMA | 310N | 186860 | Oct. 23, 2022 | 1 Year |
| 13. | EMI Test Software EZ-EMC | SHURPLE | N/A | N/A | N/A | N/A |
| 14. | MXA Spectrum Analysis | KEYSIGHT | N9020A | MY53280032 | Oct. 13, 2022 | 1 Year |
| 15. | MXG RF Vector Signal Generator | Agilent | N5182A | MY48180656 | Oct. 13, 2022 | 1 Year |
| 16. | Signal Generator | Agilent | E4421B | MY41000743 | Oct. 13, 2022 | 1 Year |
| 17. | DC Power Supply | IVYTECH | IV3605 | 1804D360510 | Oct. 22, 2022 | 1 Year |
| 18. | Constant Temperature Humidity Chamber | ZHONGJIAN | ZJ-KHWS80B | N/A | Oct. 19, 2022 | 1 Year |
| 19. | Power Meter | Agilent | N1914A | MY50001102 | Oct.26, 2022 | 1 Year |



1.7. Measurement Uncertainty

| | | |
|------------------------|---|--------------------------|
| Radiation Uncertainty | : | Ur = 3.9 dB (Horizontal) |
| | : | Ur = 3.8 dB (Vertical) |
| Conduction Uncertainty | : | Uc = 3.4 dB |

1.8. Description of Test Facility

The test facility is recognized, certified, or accredited by the following organizations:

FCC-Registration No.: 184111

Shenzhen Anbotek Compliance Laboratory Limited, EMC Laboratory has been registered and fully described in a report filed with the (FCC) Federal Communications Commission. The acceptance letter from the FCC is maintained in our files. Registration No. 184111.

ISED-Registration No.: 8058A

Shenzhen Anbotek Compliance Laboratory Limited, EMC Laboratory has been registered and fully described in a report filed with the (ISED) Innovation, Science and Economic Development Canada. The acceptance letter from the ISED is maintained in our files. Registration 8058A.

Test Location

Shenzhen Anbotek Compliance Laboratory Limited.

1/F, Building D, Sogood Science and Technology Park, Sanwei community, Hangcheng Street, Bao'an District, Shenzhen, Guangdong, China.518102



2. Summary of Test Results

| Standard Section | Test Item | Result |
|---|-----------------------------|--------|
| 15.203/15.247(c) | Antenna Requirement | PASS |
| 15.207 | Conducted Emission | PASS |
| 15.205/15.209 | Spurious Emission | PASS |
| 15.247(b)(3) | Conducted Peak Output Power | PASS |
| 15.247(a)(2) | 6dB Occupied Bandwidth | PASS |
| 15.247(e) | Power Spectral Density | PASS |
| 15.247(d) | Band Edge | PASS |
| Remark: "N/A" is an abbreviation for Not Applicable. | | |



3. Conducted Emission Test

3.1. Test Standard and Limit

| Test Standard | FCC Part15 Section 15.207 | | |
|---------------|---------------------------|--------------------------------|---------------|
| Test Limit | Frequency | Maximum RF Line Voltage (dBuV) | |
| | | Quasi-peak Level | Average Level |
| | 150kHz~500kHz | 66 ~ 56 * | 56 ~ 46 * |
| | 500kHz~5MHz | 56 | 46 |
| 5MHz~30MHz | 60 | 50 | |

Remark:(1) *Decreasing linearly with logarithm of the frequency.
 (2) The lower limit shall apply at the transition frequency.

3.2. Test Setup

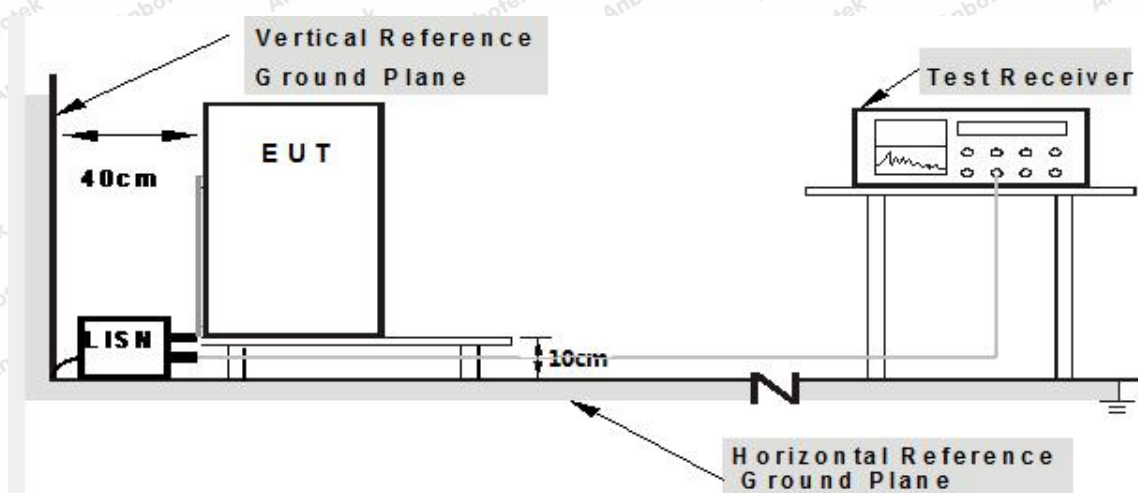

Note: 1. Support units were connected to second LISN.

2. Both of LISNs (AMN) are 80 cm from EUT and at least 80 from other units and other metal planes

3.3. Test Procedure

The EUT system is connected to the power mains through a line impedance stabilization network (L.I.S.N.). This provides a 50ohm coupling impedance for the EUT system. Please refer the block diagram of the test setup and photographs. Both sides of AC line are checked to find out the maximum conducted emission. In order to find the maximum emission levels, the relative positions of equipment and all of the interface cables shall be changed according to FCC ANSI C63.10: 2020 on Conducted Emission Measurement.

The bandwidth of test receiver (ESCI) set at 9kHz.

The frequency range from 150kHz to 30MHz is checked.



3.4. Test Data

During the test, pre-scan all modes, only the worst case is recorded in the report.

AC conducted emission pre-test at both at AC 120V/60Hz and AC 240V/60Hz modes, recorded worst case AC 120V/60Hz.

Please to see the following pages.



Conducted Emission Test Data

Test Site: 1# Shielded Room
 Operating Condition: 2402MHz
 Test Specification: AC 120V, 60Hz
 Comment: Live Line
 Temp.(°C)/Hum.(%RH): 28°C/51%RH

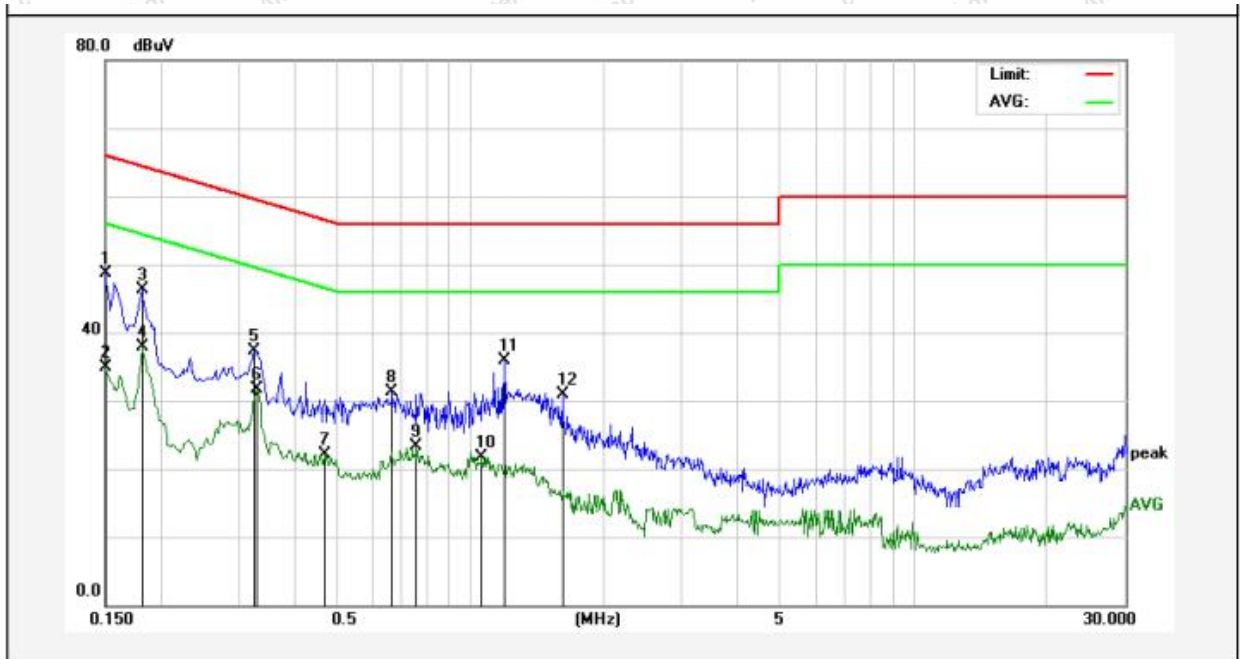

| No. | Freq. (MHz) | Reading (dBuV) | Factor (dB) | Result (dBuV) | Limit (dBuV) | Over Limit (dB) | Detector | Remark |
|-----|-------------|----------------|-------------|---------------|--------------|-----------------|----------|--------|
| 1 | 0.1499 | 38.90 | 9.82 | 48.72 | 66.00 | -17.28 | QP | |
| 2 | 0.1499 | 25.15 | 9.82 | 34.97 | 56.00 | -21.03 | AVG | |
| 3 | 0.1819 | 36.42 | 9.83 | 46.25 | 64.39 | -18.14 | QP | |
| 4 | 0.1819 | 28.13 | 9.83 | 37.96 | 54.39 | -16.43 | AVG | |
| 5 | 0.3260 | 27.45 | 9.82 | 37.27 | 59.55 | -22.28 | QP | |
| 6 | 0.3300 | 21.88 | 9.82 | 31.70 | 49.45 | -17.75 | AVG | |
| 7 | 0.4699 | 12.29 | 9.84 | 22.13 | 46.52 | -24.39 | AVG | |
| 8 | 0.6660 | 21.36 | 9.87 | 31.23 | 56.00 | -24.77 | QP | |
| 9 | 0.7580 | 13.53 | 9.87 | 23.40 | 46.00 | -22.60 | AVG | |
| 10 | 1.0620 | 11.90 | 9.85 | 21.75 | 46.00 | -24.25 | AVG | |
| 11 | 1.1939 | 26.04 | 9.84 | 35.88 | 56.00 | -20.12 | QP | |
| 12 | 1.6180 | 21.05 | 9.84 | 30.89 | 56.00 | -25.11 | QP | |



Conducted Emission Test Data

Test Site: 1# Shielded Room
 Operating Condition: 2402MHz
 Test Specification: AC 120V, 60Hz
 Comment: Neutral Line
 Temp.(°C)/Hum.(%RH): 28°C/51%RH

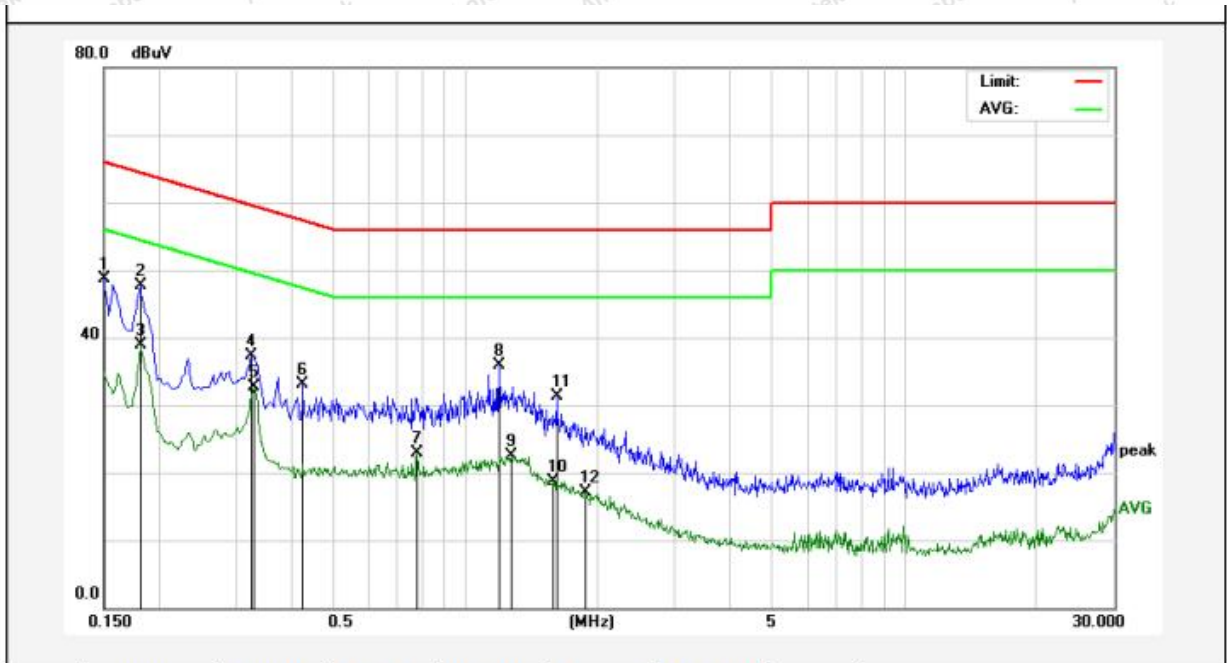

| No. | Freq. (MHz) | Reading (dBuV) | Factor (dB) | Result (dBuV) | Limit (dBuV) | Over Limit (dB) | Detector | Remark |
|-----|-------------|----------------|-------------|---------------|--------------|-----------------|----------|--------|
| 1 | 0.1500 | 38.90 | 9.82 | 48.72 | 65.99 | -17.27 | QP | |
| 2 | 0.1819 | 37.92 | 9.83 | 47.75 | 64.39 | -16.64 | QP | |
| 3 | 0.1819 | 29.13 | 9.83 | 38.96 | 54.39 | -15.43 | AVG | |
| 4 | 0.3260 | 27.45 | 9.82 | 37.27 | 59.55 | -22.28 | QP | |
| 5 | 0.3300 | 22.88 | 9.82 | 32.70 | 49.45 | -16.75 | AVG | |
| 6 | 0.4260 | 23.31 | 9.82 | 33.13 | 57.33 | -24.20 | QP | |
| 7 | 0.7780 | 13.06 | 9.86 | 22.92 | 46.00 | -23.08 | AVG | |
| 8 | 1.1940 | 26.04 | 9.84 | 35.88 | 56.00 | -20.12 | QP | |
| 9 | 1.2740 | 12.68 | 9.84 | 22.52 | 46.00 | -23.48 | AVG | |
| 10 | 1.5859 | 8.90 | 9.84 | 18.74 | 46.00 | -27.26 | AVG | |
| 11 | 1.6180 | 21.55 | 9.84 | 31.39 | 56.00 | -24.61 | QP | |
| 12 | 1.8860 | 7.36 | 9.83 | 17.19 | 46.00 | -28.81 | AVG | |



4. Radiation Spurious Emission and Band Edge

4.1. Test Standard and Limit

| Test Standard | FCC Part15 C Section 15.209 and 15.205 | | | | |
|---------------|--|----------------------------------|----------------|------------|--------------------------|
| Test Limit | Frequency (MHz) | Field strength (microvolt/meter) | Limit (dBuV/m) | Remark | Measurement distance (m) |
| | 0.009MHz~0.490MHz | 2400/F(kHz) | - | - | 300 |
| | 0.490MHz-1.705MHz | 24000/F(kHz) | - | - | 30 |
| | 1.705MHz-30MHz | 30 | - | - | 30 |
| | 30MHz~88MHz | 100 | 40.0 | Quasi-peak | 3 |
| | 88MHz~216MHz | 150 | 43.5 | Quasi-peak | 3 |
| | 216MHz~960MHz | 200 | 46.0 | Quasi-peak | 3 |
| | 960MHz~1000MHz | 500 | 54.0 | Quasi-peak | 3 |
| | Above 1000MHz | 500 | 54.0 | Average | 3 |
| | | - | 74.0 | Peak | 3 |

Remark:

(1)The lower limit shall apply at the transition frequency.

(2) 15.35(b), Unless otherwise specified, the limit on peak radio frequency emissions is 20dB above the maximum permitted average emission limit applicable to the equipment under test. This peak limit applies to the total peak emission level radiated by the device.

4.2. Test Setup

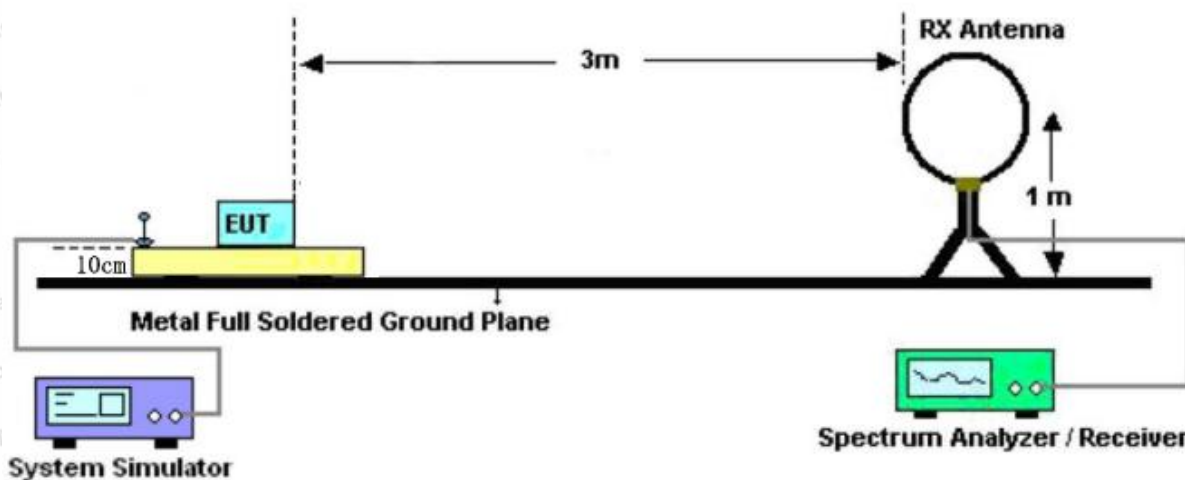

Figure 1. Below 30MHz



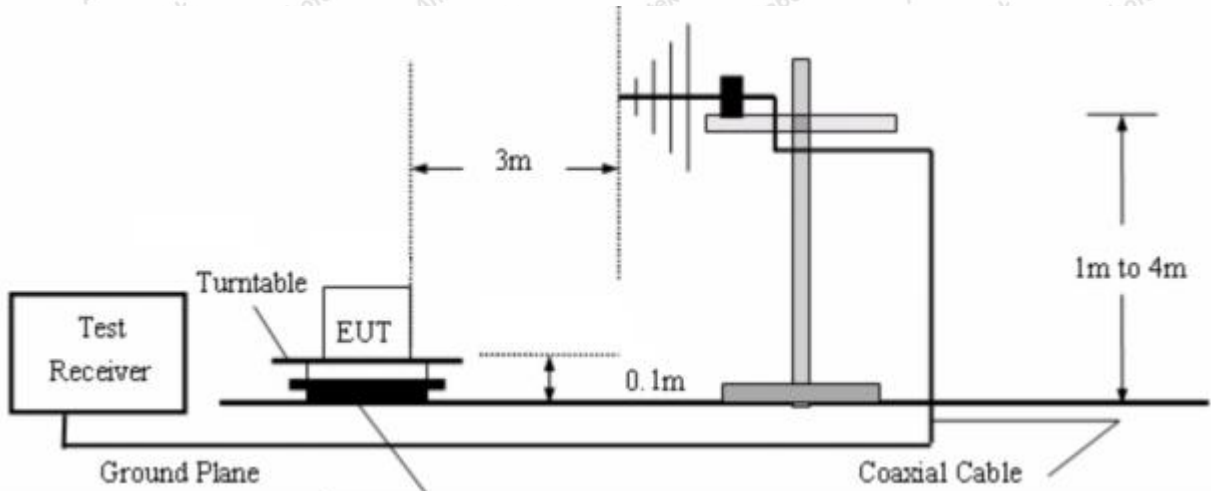

Figure 2. 30MHz to 1GHz

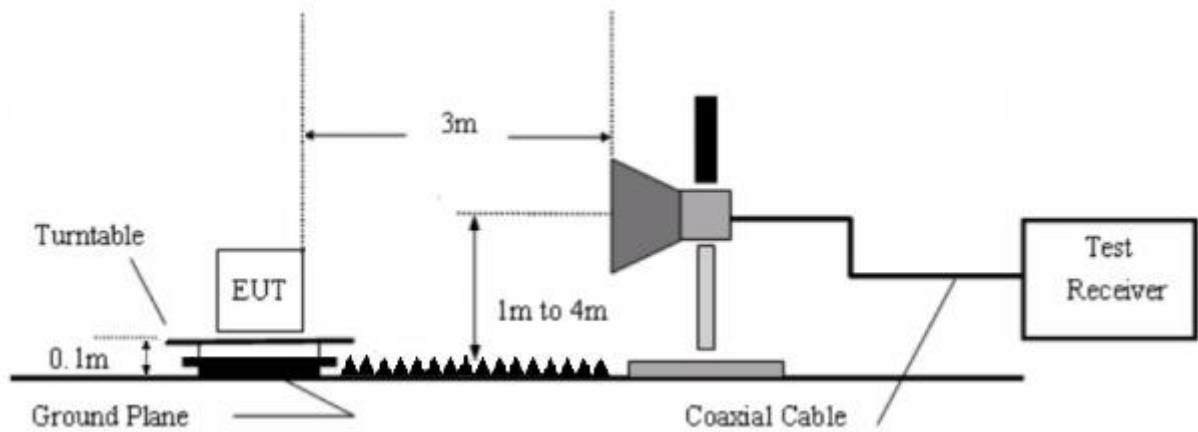

Figure 3. Above 1 GHz

4.3. Test Procedure

For below 1GHz: The EUT is placed on a turntable, which is 0.1m above the ground plane.

For above 1GHz: The EUT is placed on a turntable, which is 0.1m above the ground plane.

The turn table can rotate 360 degrees to determine the position of the maximum emission level. The EUT is set 3 meters away from the receiving antenna which is mounted on a antenna tower. The antenna can be moved up and down from 1 to 4 meters to find out the maximum emission level. Rotated the EUT through three orthogonal axes to determine the maximum emissions, both horizontal and vertical polarization of the antenna are set on test. The EUT is tested in 9*6*6 Chamber. The device is evaluated in xyz orientation.

For the radiated emission test above 1GHz:

Place the measurement antenna away from each area of the EUT determined to be a source of emissions at the specified measurement distance, while keeping the measurement antenna aimed at the source of emissions at each frequency of significant emissions, with polarization oriented for maximum response. The measurement antenna may have to be higher or lower than the EUT, depending on the radiation pattern of the emission and staying aimed at the emission source for receiving the maximum signal. The final measurement antenna elevation shall be that which maximizes the emissions. The measurement antenna elevation for maximum emissions shall be



restricted to a range of heights of from 1 m to 4 m above the ground or reference ground plane.

For 9kHz to 150kHz, Set the spectrum analyzer as:

RBW = 200Hz, VBW = 1kHz, Detector= Quasi-Peak, Trace mode= Max hold, Sweep- auto couple.

For 150kHz to 30MHz, Set the spectrum analyzer as:

RBW = 9KHz, VBW = 30kHz, Detector= Quasi-Peak, Trace mode= Max hold, Sweep- auto couple.

For 30MHz to 1000MHz, Set the spectrum analyzer as:

RBW = 100kHz, VBW = 300kHz, Detector= Quasi-Peak, Trace mode= Max hold, Sweep- auto couple.

For above 1GHz, Set the spectrum analyzer as:

RBW = 1MHz, VBW = 1MHz, Detector= Peak, Trace mode= Max hold, Sweep- auto couple.

For average measurement:

-VBW=10Hz, When duty cycle is no less than 98 percent

-VBW $\geq 1/T$, when duty cycle is less than 98 percent where T is the minimum transmission duration over which the transmitter is on and is transmitting at its maximum power control level for the tested mode of operation, so refer to this clause 5.4 duty cycle.

4.4. Test Data

PASS

During the test, Pre-scan all kind of the place mode (X-axis, Y-axis, Z-axis), and found the X-axis is the worst case.

The test results of 9kHz-30MHz was attenuated more than 20dB below the permissible limits, so the results don't record in the report.

During the test, pre-scan all modes, only the worst case is recorded in the report.



Test Results (30~1000MHz)

Test Mode: 2402MHz
 Power Source: AC 120V, 60Hz
 Polarization: Horizontal
 Temp.(°C)/Hum.(%RH): 23.5°C/49%RH

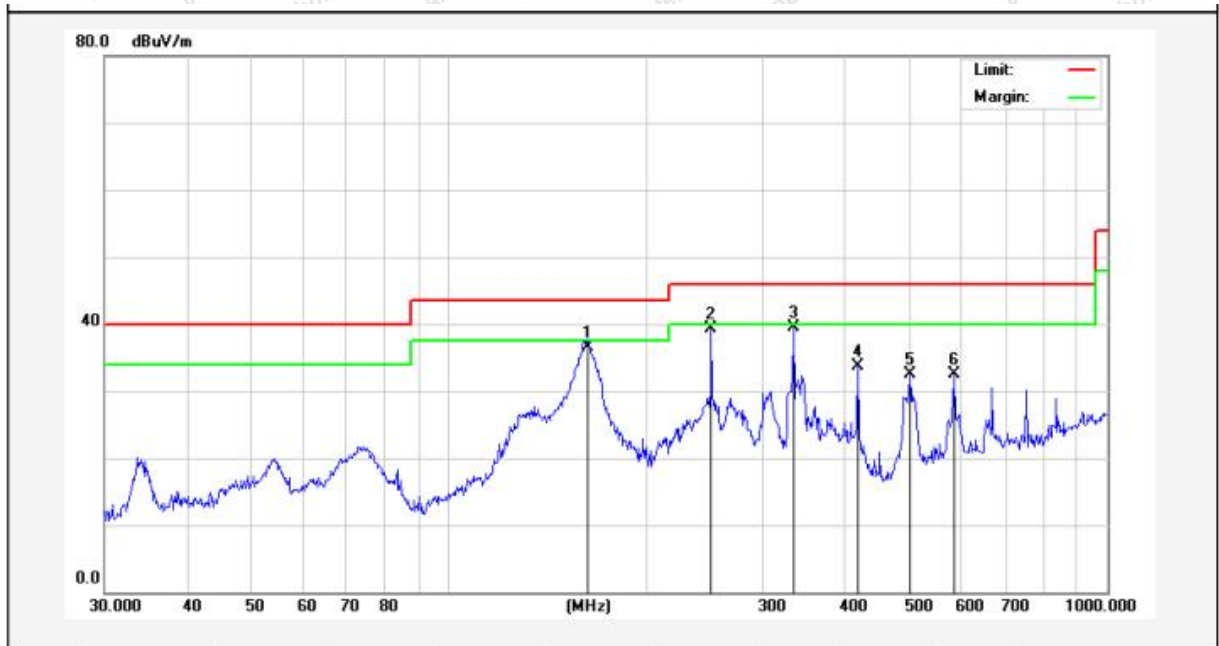

| No. | Freq. (MHz) | Reading (dBuV) | Factor (dB/m) | Result (dBuV/m) | Limit (dBuV/m) | Over Limit (dB) | Detector | Height (cm) | degree (deg) | Remark |
|-----|-------------|----------------|---------------|-----------------|----------------|-----------------|----------|-------------|--------------|--------|
| 1 | 162.6106 | 60.44 | -23.92 | 36.52 | 43.50 | -6.98 | QP | | | |
| 2 | 250.3011 | 60.70 | -21.47 | 39.23 | 46.00 | -6.77 | QP | | | |
| 3 | 333.6865 | 55.93 | -16.38 | 39.55 | 46.00 | -6.45 | QP | | | |
| 4 | 417.6409 | 49.70 | -15.90 | 33.80 | 46.00 | -12.20 | QP | | | |
| 5 | 501.1789 | 46.22 | -13.72 | 32.50 | 46.00 | -13.50 | QP | | | |
| 6 | 584.7894 | 43.46 | -10.90 | 32.56 | 46.00 | -13.44 | QP | | | |



Test Results (30~1000MHz)

Test Mode: 2402MHz
 Power Source: AC 120V, 60Hz
 Polarization: Vertical
 Temp.(°C)/Hum.(%RH): 23.5°C/49%RH

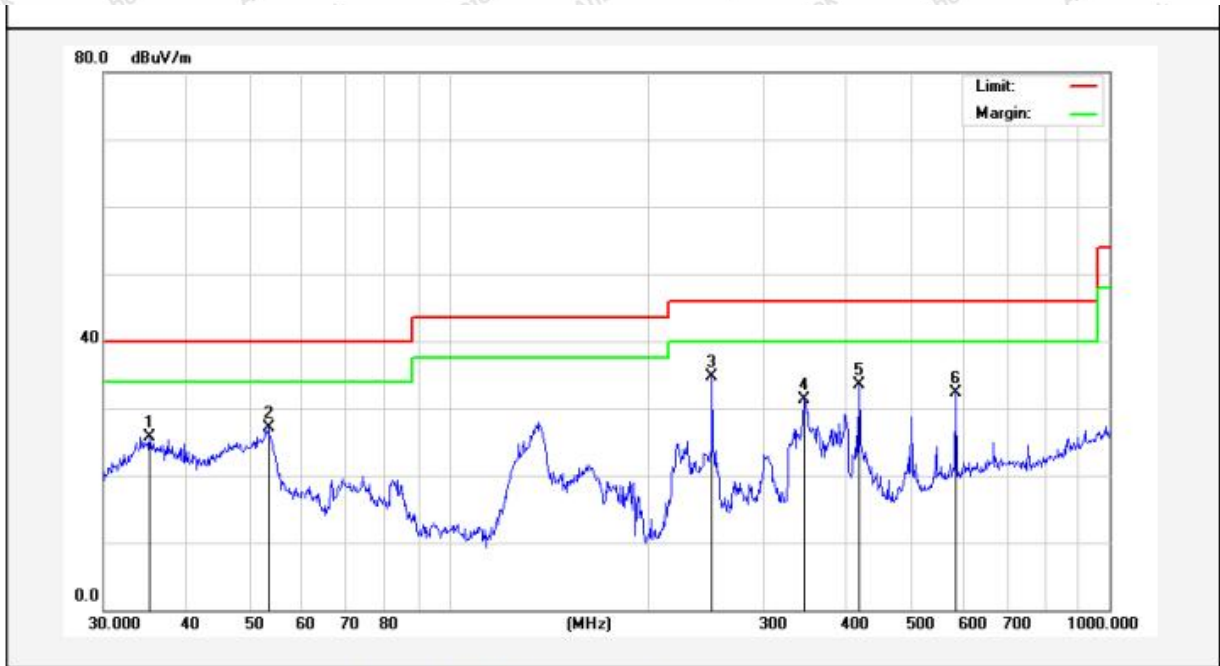

| No. | Freq. (MHz) | Reading (dBuV) | Factor (dB/m) | Result (dBuV/m) | Limit (dBuV/m) | Over Limit (dB) | Detector | Height (cm) | degree (deg) | Remark |
|-----|-------------|----------------|---------------|-----------------|----------------|-----------------|----------|-------------|--------------|--------|
| 1 | 35.2512 | 42.63 | -17.01 | 25.62 | 40.00 | -14.38 | QP | | | |
| 2 | 53.3179 | 44.07 | -17.00 | 27.07 | 40.00 | -12.93 | QP | | | |
| 3 | 250.3012 | 52.61 | -17.92 | 34.69 | 46.00 | -11.31 | QP | | | |
| 4 | 345.5952 | 46.38 | -15.12 | 31.26 | 46.00 | -14.74 | QP | | | |
| 5 | 417.6411 | 47.76 | -14.17 | 33.59 | 46.00 | -12.41 | QP | | | |
| 6 | 584.7895 | 43.30 | -10.90 | 32.40 | 46.00 | -13.60 | QP | | | |



Test Results (1GHz-25GHz)

| Test Mode: CH00 | | | | Test channel: Lowest | | |
|-----------------|----------------|---------------|-----------------|----------------------|-----------------|--------------|
| Peak value: | | | | | | |
| Frequency (MHz) | Reading (dBUV) | Factor (dB/m) | Result (dBUV/m) | Limit (dBUV/m) | Over Limit (dB) | polarization |
| 4804.00 | 27.25 | 15.27 | 42.52 | 74.00 | -31.48 | Vertical |
| 7206.00 | 27.52 | 18.09 | 45.61 | 74.00 | -28.39 | Vertical |
| 9608.00 | 27.96 | 23.76 | 51.72 | 74.00 | -22.28 | Vertical |
| 12010.00 | * | | | 74.00 | | Vertical |
| 14412.00 | * | | | 74.00 | | Vertical |
| 4804.00 | 27.02 | 15.27 | 42.29 | 74.00 | -31.71 | Horizontal |
| 7206.00 | 27.60 | 18.09 | 45.69 | 74.00 | -28.31 | Horizontal |
| 9608.00 | 27.60 | 23.76 | 51.36 | 74.00 | -22.64 | Horizontal |
| 12010.00 | * | | | 74.00 | | Horizontal |
| 14412.00 | * | | | 74.00 | | Horizontal |
| Average value: | | | | | | |
| Frequency (MHz) | Reading (dBUV) | Factor (dB/m) | Result (dBUV/m) | Limit (dBUV/m) | Over Limit (dB) | polarization |
| 4804.00 | 15.52 | 15.27 | 30.79 | 54.00 | -23.21 | Vertical |
| 7206.00 | 16.57 | 18.09 | 34.66 | 54.00 | -19.34 | Vertical |
| 9608.00 | 17.43 | 23.76 | 41.19 | 54.00 | -12.81 | Vertical |
| 12010.00 | * | | | 54.00 | | Vertical |
| 14412.00 | * | | | 54.00 | | Vertical |
| 4804.00 | 15.35 | 15.27 | 30.62 | 54.00 | -23.38 | Horizontal |
| 7206.00 | 16.63 | 18.09 | 34.72 | 54.00 | -19.28 | Horizontal |
| 9608.00 | 17.11 | 23.76 | 40.87 | 54.00 | -13.13 | Horizontal |
| 12010.00 | * | | | 54.00 | | Horizontal |
| 14412.00 | * | | | 54.00 | | Horizontal |



Test Results (1GHz-25GHz)

| Test Mode: CH19 | | | | Test channel: Middle | | |
|-----------------|----------------|---------------|-----------------|----------------------|-----------------|--------------|
| Peak value: | | | | | | |
| Frequency (MHz) | Reading (dBuV) | Factor (dB/m) | Result (dBuV/m) | Limit (dBuV/m) | Over Limit (dB) | polarization |
| 4880.00 | 26.80 | 15.42 | 42.22 | 74.00 | -31.78 | Vertical |
| 7320.00 | 27.49 | 18.02 | 45.51 | 74.00 | -28.49 | Vertical |
| 9760.00 | 27.46 | 23.80 | 51.26 | 74.00 | -22.74 | Vertical |
| 12200.00 | * | | | 74.00 | | Vertical |
| 14640.00 | * | | | 74.00 | | Vertical |
| 4880.00 | 26.83 | 15.42 | 42.25 | 74.00 | -31.75 | Horizontal |
| 7320.00 | 27.47 | 18.02 | 45.49 | 74.00 | -28.51 | Horizontal |
| 9760.00 | 27.32 | 23.80 | 51.12 | 74.00 | -22.88 | Horizontal |
| 12200.00 | * | | | 74.00 | | Horizontal |
| 14640.00 | * | | | 74.00 | | Horizontal |
| Average value: | | | | | | |
| Frequency (MHz) | Reading (dBuV) | Factor (dB/m) | Result (dBuV/m) | Limit (dBuV/m) | Over Limit (dB) | polarization |
| 4880.00 | 15.61 | 15.42 | 31.03 | 54.00 | -22.97 | polarization |
| 7320.00 | 16.43 | 18.02 | 34.45 | 54.00 | -19.55 | Vertical |
| 9760.00 | 17.28 | 23.80 | 41.08 | 54.00 | -12.92 | Vertical |
| 12200.00 | * | | | 54.00 | | Vertical |
| 14640.00 | * | | | 54.00 | | Vertical |
| 4880.00 | 15.46 | 15.42 | 30.88 | 54.00 | -23.12 | Vertical |
| 7320.00 | 16.98 | 18.02 | 35.00 | 54.00 | -19.00 | Horizontal |
| 9760.00 | 17.41 | 23.80 | 41.21 | 54.00 | -12.79 | Horizontal |
| 12200.00 | * | | | 54.00 | | Horizontal |
| 14640.00 | * | | | 54.00 | | Horizontal |



Test Results (1GHz-25GHz)

| Test Mode: CH39 | | | | Test channel: Highest | | |
|-----------------|----------------|---------------|-----------------|-----------------------|-----------------|--------------|
| Peak value: | | | | | | |
| Frequency (MHz) | Reading (dBuV) | Factor (dB/m) | Result (dBuV/m) | Limit (dBuV/m) | Over Limit (dB) | polarization |
| 4960.00 | 26.93 | 15.58 | 42.51 | 74.00 | -31.49 | Vertical |
| 7440.00 | 27.65 | 17.93 | 45.58 | 74.00 | -28.42 | Vertical |
| 9920.00 | 28.16 | 23.83 | 51.99 | 74.00 | -22.01 | Vertical |
| 12400.00 | * | | | 74.00 | | Vertical |
| 14880.00 | * | | | 74.00 | | Vertical |
| 4960.00 | 26.97 | 15.58 | 42.55 | 74.00 | -31.45 | Horizontal |
| 7440.00 | 27.68 | 17.93 | 45.61 | 74.00 | -28.39 | Horizontal |
| 9920.00 | 27.70 | 23.83 | 51.53 | 74.00 | -22.47 | Horizontal |
| 12400.00 | * | | | 74.00 | | Horizontal |
| 14880.00 | * | | | 74.00 | | Horizontal |
| Average value: | | | | | | |
| Frequency (MHz) | Reading (dBuV) | Factor (dB/m) | Result (dBuV/m) | Limit (dBuV/m) | Over Limit (dB) | polarization |
| 4960.00 | 16.73 | 15.58 | 32.31 | 54.00 | -21.69 | Vertical |
| 7440.00 | 17.70 | 17.93 | 35.63 | 54.00 | -18.37 | Vertical |
| 9920.00 | 17.93 | 23.83 | 41.76 | 54.00 | -12.24 | Vertical |
| 12400.00 | * | | | 54.00 | | Vertical |
| 14880.00 | * | | | 54.00 | | Vertical |
| 4960.00 | 16.64 | 15.58 | 32.22 | 54.00 | -21.78 | Horizontal |
| 7440.00 | 17.78 | 17.93 | 35.71 | 54.00 | -18.29 | Horizontal |
| 9920.00 | 17.56 | 23.83 | 41.39 | 54.00 | -12.61 | Horizontal |
| 12400.00 | * | | | 54.00 | | Horizontal |
| 14880.00 | * | | | 54.00 | | Horizontal |

Remark:

1.Result =Read level + Factor

2. “*” means the test results were attenuated more than 20dB below the permissible limits, so the results don't record in the report.



Radiated Band Edge:



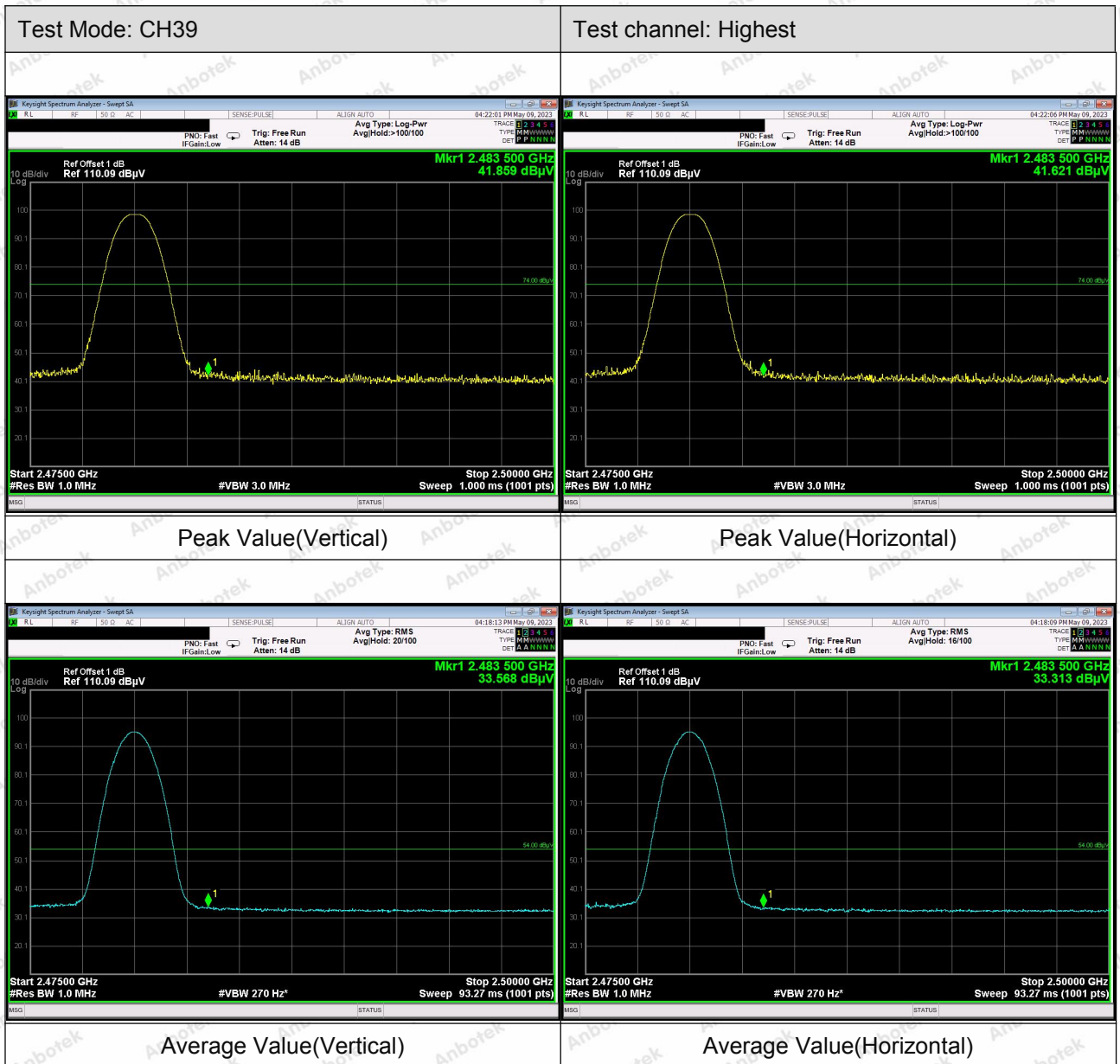

5. Maximum Peak Output Power Test

5.1. Test Standard and Limit

| | |
|---------------|------------------------------------|
| Test Standard | FCC Part15 C Section 15.247 (b)(3) |
| Test Limit | 1W (30dBm) |

5.2. Test Setup

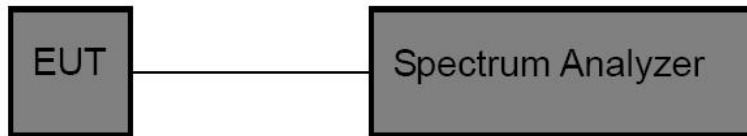

5.3. Test Procedure

This procedure shall be used when the measurement instrument has available a resolution bandwidth that is greater than the DTS bandwidth.

1. Set the RBW \geq DTS bandwidth.
2. Set the VBW ≥ 3 *RBW.
3. Set the span ≥ 3 *RBW.
4. Detector = peak.
5. Sweep time = auto couple.
6. Trace mode = max hold.
7. Allow trace to fully stabilize.
8. Use peak marker function to determine the peak amplitude level.

5.4. Test Data

Pass

Please refer to Appendix C of the Appendix Test Data.

Additional test for duty cycle.

Please refer to Appendix G of the Appendix Test Data.



6. 6dB Occupancy Bandwidth Test

6.1. Test Standard and Limit

| | |
|---------------|------------------------------------|
| Test Standard | FCC Part15 C Section 15.247 (a)(2) |
| Test Limit | ≥500kHz |

6.2. Test Setup

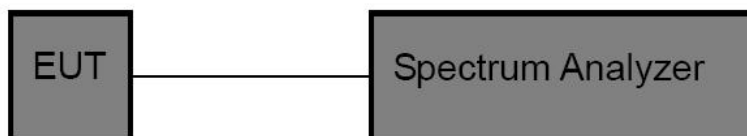

6.3. Test Procedure

1. Place the EUT on the table and set it in the transmitting mode.
2. Remove the antenna from the EUT and then connect a low loss RF cable from the antenna port to the spectrum analyzer.
3. Set the spectrum analyzer as:
RBW = 100kHz, VBW≥3*RBW
Detector= Peak
Trace mode= Max hold.
Sweep- auto couple.
4. Mark the peak frequency and -6dB (upper and lower) frequency.
5. Repeat until all the rest channels are investigated.

6.4. Test Data

Pass

Please refer to Appendix A of the Appendix Test Data.



7. Power Spectral Density Test

7.1. Test Standard and Limit

| | |
|---------------|---------------------------------|
| Test Standard | FCC Part15 C Section 15.247 (e) |
| Test Limit | 8dBm/3kHz |

7.2. Test Setup



7.3. Test Procedure

1. Place the EUT on the table and set it in transmitting mode. Remove the antenna from the EUT and then connect a low loss RF cable from the antenna port to the spectrum analyzer.
2. Set the spectrum analyzer as RBW = 3kHz, VBW $\geq 3 \times$ RBW, Span = 1.5x DTS BW
3. Record the max. reading.
4. Repeat the above procedure until the measurements for all frequencies are completed.

7.4. Test Data

Pass

Please refer to Appendix D of the Appendix Test Data.



8. 100kHz Bandwidth of Frequency Band Edge Requirement

8.1. Test Standard and Limit

| | |
|---------------|--|
| Test Standard | FCC Part15 C Section 15.247 (d) |
| Test Limit | In any 100 kHz bandwidth outside the frequency bands in which the spread spectrum intentional radiator is operating, the radio frequency power that is produced by the intentional radiator shall be at least 20dB below that in the 100kHz bandwidth within the band that contains the highest level of the desired power, In addition, radiated emissions which fall in the restricted bands, as defined in §15.205(a), must also comply with the radiated emission limits specified in 15.209(a). |

8.2. Test Setup

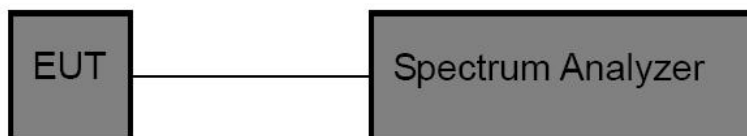

8.3. Test Procedure

Using the following spectrum analyzer setting:

1. Set the RBW = 100kHz.
2. Set the VBW = 300kHz.
3. Sweep time = auto couple.
4. Detector function = peak.
5. Trace mode = max hold.
6. Allow trace to fully stabilize.

8.4. Test Data

Pass

Please refer to Appendix E&F of the Appendix Test Data.



9. Antenna Requirement

9.1. Test Standard and Requirement

| | |
|---------------|---|
| Test Standard | FCC Part15 Section 15.203 /247(c) |
| Requirement | <p>1) 15.203 requirement: An intentional radiator shall be designed to ensure that no antenna other than that furnished by the responsible party shall be used with the device. The use of a permanently attached antenna or of an antenna that uses a unique coupling to the intentional radiator, the manufacturer may design the unit so that a broken antenna can be replaced by the user, but the use of a standard antenna jack or electrical connector is prohibited.</p> <p>2) 15.247(c) (1)(i) requirement: Systems operating in the 2400-2483.5 MHz band that is used exclusively for fixed. Point-to-point operations may employ transmitting antennas with directional gain greater than 6dBi provided the maximum conducted output power of the intentional radiator is reduced by 1 dB for every 3 dB that the directional gain of the antenna exceeds 6 dBi.</p> |

9.2. Antenna Connected Construction

The antenna is a External Antenna which permanently attached, and the best case gain of the antenna is 5.09dBi . It complies with the standard requirement.



APPENDIX I -- TEST SETUP PHOTOGRAPH

Please refer to separated files Appendix I -- Test Setup Photograph

APPENDIX II -- EXTERNAL PHOTOGRAPH

Please refer to separated files Appendix II -- External Photograph

APPENDIX III -- INTERNAL PHOTOGRAPH

Please refer to separated files Appendix III -- Internal Photograph

----- End of Report -----

