

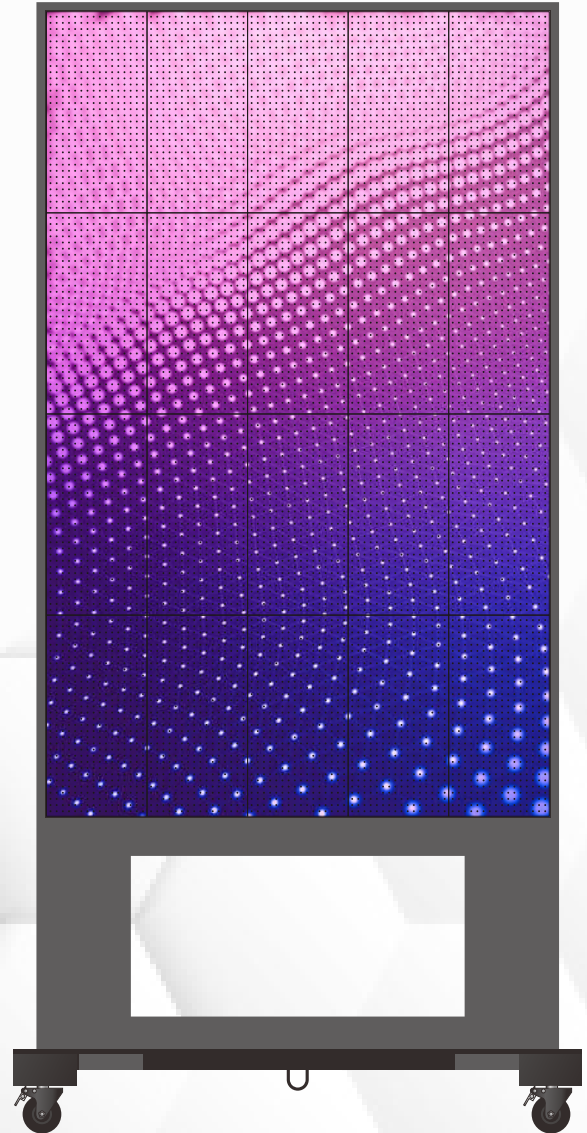

DISPLAYS2GO
CONNECTING PEOPLE & BRANDS WITH THE WORLD

60" Direct View LED Outdoor Portable Digital Signage

USER MANUAL



SKU: DW060VB

PRODUCT DESCRIPTION: Digital LED Poster 2.5mm

FCC ID: 2ASCB-DW060VB

This device complies with Part 15 of the FCC Rules. Operation is subject to the following two conditions:

- (1) this device may not cause harmful interference, and
- (2) this device must accept any interference received, including interference that may cause undesired operation.

Any changes/modifications to this equipment not approved by the party responsible for compliance could void the user's authority to operate the equipment.



Thank you for purchasing this product from Displays2go.

It's our mission to help you connect with the world and build your brand with products that are personalized to your needs.

Your product has been manufactured with great care using only the finest quality materials and expert workmanship. Our Quality Assurance team inspects all electronics during assembly process to assure reliable operation. This product comes with a 12-month warranty. Scan the QR code to visit the product page and learn more about your warranty.

Need assistance? We are available for expert advice and all of your customer service needs.



Chat Us
DISPLAYS2GO.COM



Email Us
INFO@DISPLAYS2GO.COM



Call Us
1-877-671-3388

TABLE OF CONTENTS

Before Use

Safety and Warnings	4
Packing List	7
Description of Parts	7
Assembly	8

Operation

Power On/Off	9
Displaying Content with ViPlex Express	10
Create New Solution	11
Publish Solution	12
Unit Connection Methods	13

Reference

Technical Specifications	14
Cleaning and Maintenance	15
Troubleshooting Guide	16
Names and Contents of Toxic and Hazardous Substances or Elements in the Product	17
FCC Statement	18



BEFORE USE

Safety Warnings and Precautions

Thank you for purchasing the high-performance Digital Signage from Displays2Go. We have considered the factors to ensure personal safety in product design and have tested rigorously at the factory. However, improper installation and use may result in electric shock and fire.

In order to safely use, maximize performance of the unit and extend the life of the product, please read and follow all instructions carefully before using the product. Keep the instructions for future reference.

We strongly recommend using a surge protector, or a power strip with internal circuit breaker to prevent damages to the digital signage.

	Warning: May cause personal injury or death
	The operation is prohibited
	Caution: May cause damage or property loss



If any of the following occurs:

- Power outage or instable voltage.
- Abnormal sound or smell from the unit.
- AC power cord is damaged.
- Digital Signage is damaged due to drop, knock or impact.
- Any liquid or foreign matters fall into the enclosure.



Turn off the Digital Signage immediately, pull out the plug from the power outlet, and ask the authorized personnel for maintenance timely.



If coal gas or other flammable gas leaks, do not pull out the plug of the digital signage or other electrical appliances; instead, turn off the gas valve immediately, and open the doors and windows quickly.

 **WARNING**

- Cut off the power supply before connecting or disconnecting any cables.
- Do not place the Digital Signage on any instable positions, or else it may be damaged or cause fire.
- Do not place the Digital Signage in the positions such as:
 - The environment subject to direct strong sunlight, moisture, extreme temperature or too much dust,
 - The environment with flammable or explosive materials,
 - The environment with flammable or corrosive gases,
- Do not use damaged or inappropriate power outlets, and ensure that the plugs and outlets contact properly.
- Do not let dust or metal deposits adhere to the plugs and outlets.
- Do not damage the power cords:
- Do not modify the power cords,
- Do not place heavy objects on the power cords,
 - Keep the power cords away from heat source,
 - Do not pull the cord to remove the plug.
 - Do not connect too many plugs to one outlet in parallel, or else it may cause fire due to excessive power consumption.
- Do not approach the Digital Signage with open flame (e.g. a lighted candle), or else it may cause electric shock or fire.
- Do not put any sharp objects, metal or liquid into the vents or let them touch the signal terminals to avoid short circuit, product damage, and electric shock.
- The openings in the enclosure are designed for ventilation and cooling, to ensure long time reliable running of components inside the enclosure and prevent overheating. Do not block the openings when place the unit.



Do not touch the plugs with wet fingers, or else it will cause electric shock.



Do not use the Digital Signage in stormy weather, especially when there is lightning, instead, please disconnect the power and antenna plugs to avoid lightning strike.



Do not disassemble the Digital Signage without permission, or else it may cause electric shock or fire. Please ask qualified technician for repair.



CAUTION

- Do not let children climb onto the Digital Signage.
- Keep the small parts away from children to prevent them from swallowing.
- If the Digital Signage won't be used for a long time, please turn it off and pull out the power plug.
- To adjust the position of the Digital Signage, please disconnect all power cords and move slowly to avoid tip over.
- Do not scratch or knock the unit with hard object, or twist and squeeze the unit.
- Do not turn on the unit immediately when it is moved from a place with low temperature to high temperature, or else it will cause condensation and malfunction.
- Before cleaning the Digital Signage, please pull out the power plug, wipe with soft cloth, do not use industrial chemicals, prevent foreign matters from entering the machine. Improper cleaning (such as cleaning solution, water) may damage the product, erase the printed information, and even cause damage of the components if fluid flows in, resulting in machine failure.
- If the unit displays the same screen for a long time or the moving picture has fixed text or icon, it will leave ghosting on the screen and won't disappear when the unit is turned off, it is normal and isn't covered by the warranty.
- The power of the Digital Signage can be cut off by pulling out the plug.
- If the screen ruptures and the liquid splashes on the skin, please rinse for 15 minutes with clean water immediately, and consult your doctor.
- To carry the Digital Signage with hands, please grab and hold the edges, do not apply pressure on the panel.
- Use the Digital Signage properly: Use in proper lighting conditions, insufficient lighting or long time watching will impair your eyesight.
- Unplug device to disconnect from power.
- Insert the plug into the outlet properly, or else it may cause sparks and fire.

The technical specifications printed herein and on the packaging are subject to change without prior notice. The Manual may be slightly different from actual operation, and the latter is applicable.

Contact Displays2go if you have questions about the operation, debugging and connection of the unit, if the unit doesn't work normally, please cut off the power immediately and consult the dealer. The unit is class-A product, which may cause radio interference in living environment. In this case, please take feasible measures, and use power plug as the disconnection device.

Packing List

Name	Quantity
LED Screen Body	1
Base	1
Pull-strap	2
User Manual	1

Hardware Package	Quantity
Hex Wrench	1
Hex Screw M8x20	10
Washer	10

Description of Parts

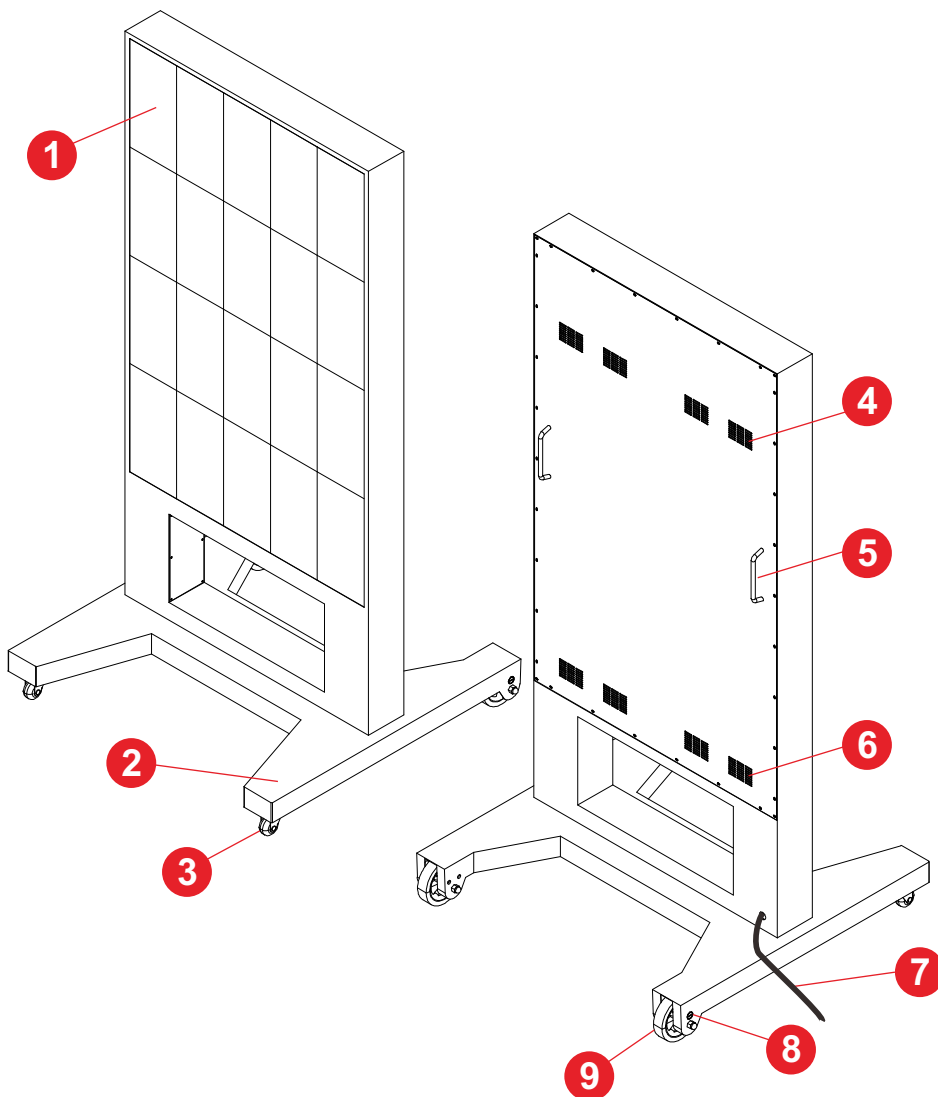

#	Description
1	LED Screen Body
2	Base
3	Locking Caster Wheels
4	Cooling Vents
5	Handles
6	Interface Panel
7	Speakers
8	Antennae
9	Power Cord

If you have any questions regarding our products, please visit us at www.displays2go.com or contact Displays2go customer service at 844-221-3388.

Assembly

! **NOTE:** Three people required for safe assembly of product. Always unplug power cord before installing or disassembling the unit!



**3 PEOPLE REQUIRED
FOR ASSEMBLY**

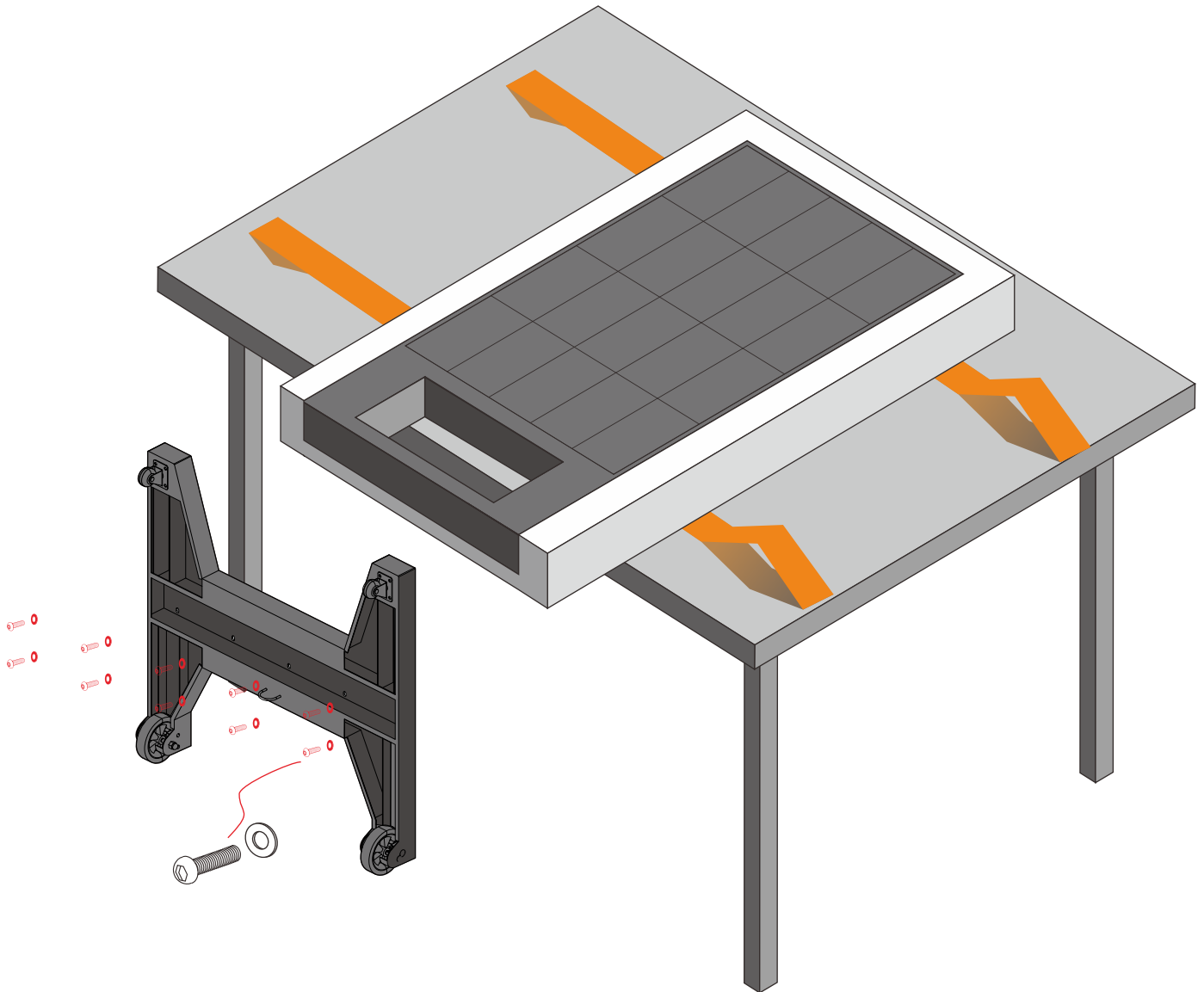

1. Lay pull-straps on a soft and non-abrasive surface, then gently lay down LED screen.
2. Attach LED screen and base using M8x20 screws and washers.
3. Using pull-straps, carefully raise unit to standing position.

OPERATION

Power On/Off

- Power on by inserting the power cord into unit and connecting to outlet. Turn screen on with I/O switch.
- To turn the screen on or off, use I/O switch on unit.
- To shut down, use I/O switch on unit, then unplug the unit.

Once connected to power, the LEDs light up after a brief pause and the IP address is active.

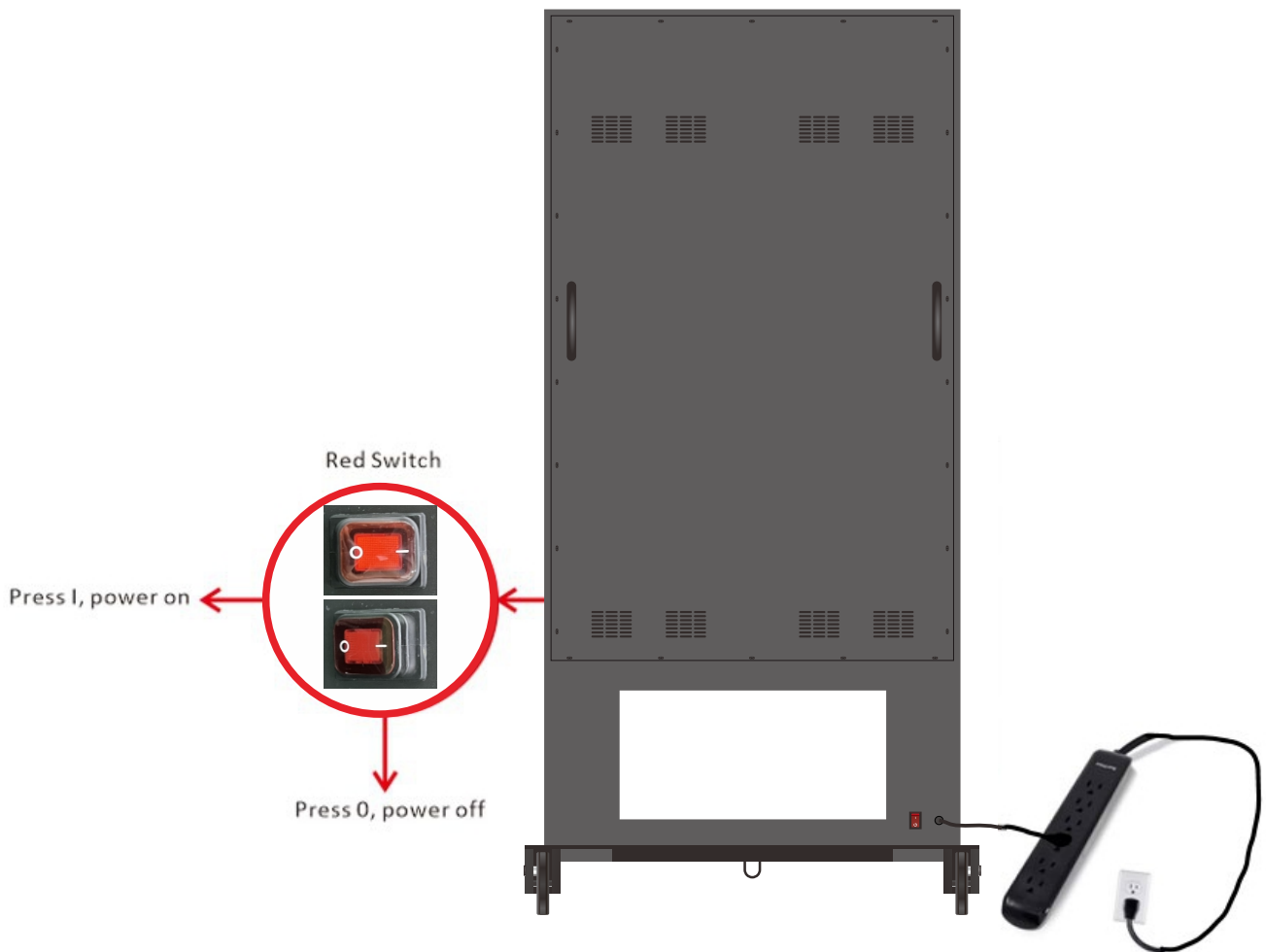

! **NOTE:** We recommend using a surge protector or power strip with internal circuit breaker to prevent potential damages to the product.

Displaying Content with ViPlex Express

To display content, you first need to create and publish a solution in ViPlex Express software. ViPlex Express is a program for creating, editing, and displaying content on your LED display.

Download ViPlex Express on PC

The unit's IP address is live once the unit is powered on.

1. Download the software on its official website ViPlex Express and click the Nova Cloud tab. Then, scroll to ViPlex Express. <https://www.novastar.tech/downloads>
2. Choose ViPlex Express x32 or x64.

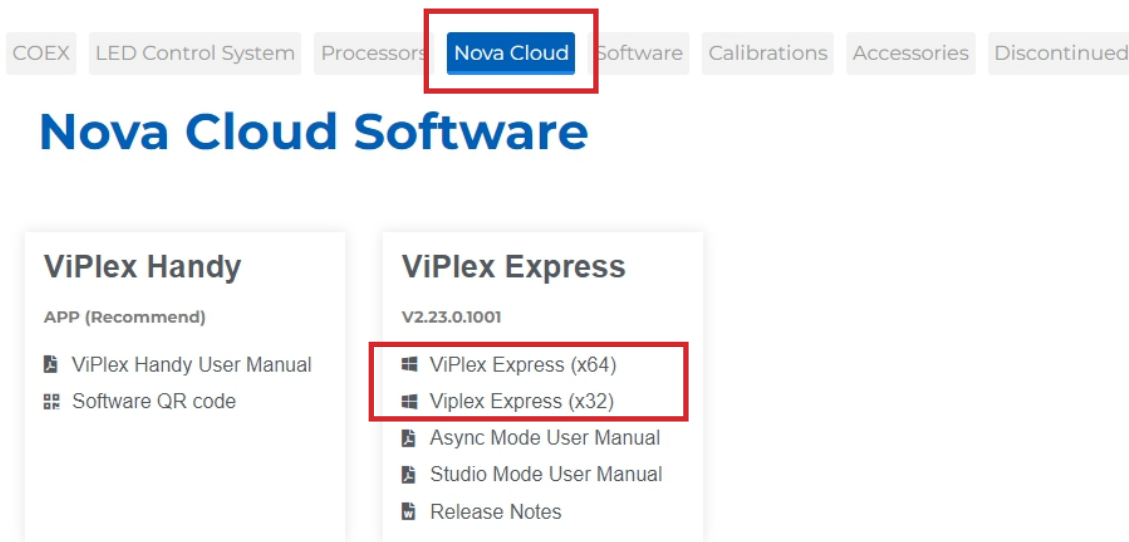

! **NOTE:** Check your PC device specifications to determine if x32 or x64 is right for your system.

Log Into ViPlex Express

1. Open ViPlex Express application. The IP addresses of all units appear listed in the Screen Management tab. Choose an available unit from the list, then click Connect
2. Enter the username and password then click OK.

Initial Username: **admin**

Initial Password: **123456**

Create New Solution

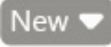
1. In the Solutions tab, click New  in the top left corner. Select **Regular Scale**. The Solution Information window appears.
2. Name your Solution, then enter the resolution.
Width: 320
Height: 512
3. Click OK. The Edit Solution window appears.

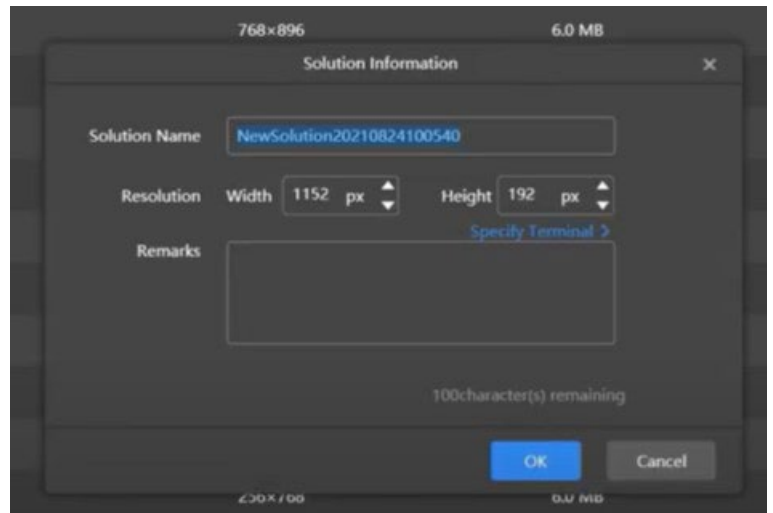

From here you can add content, edit settings, and personalize the solution with widgets and customizations.

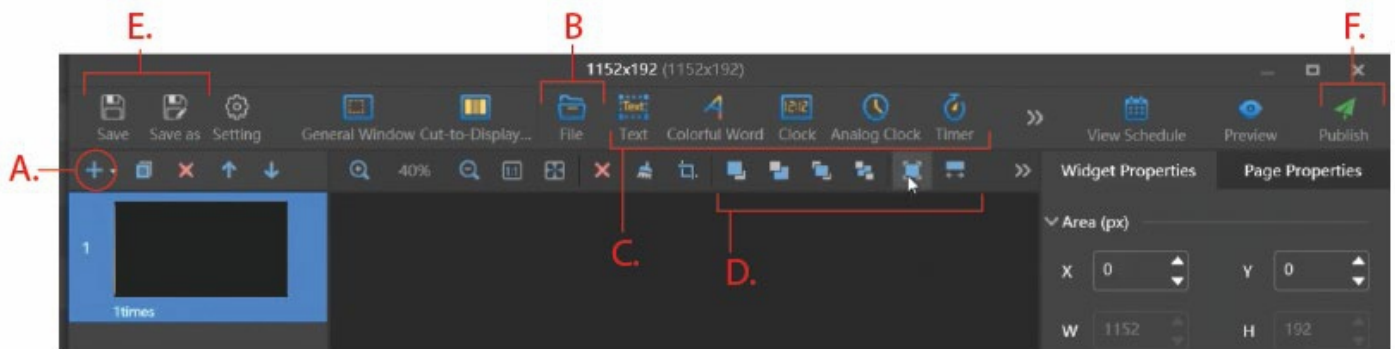

A.	Click [+] to add a page to your solution.
B.	Click File to insert images or video on the page. NOTE: Resolution of image must match Solution resolution.
C.	Customize page by adding text, widgets, and more.
D.	Position image or video on the page using the toolbar.
E.	Save progress. All saved playlists appear in the Solutions tab.
F.	Publish solution to unit (see next page for more).

Publish Solution

Publish your solution by clicking the green Publish icon. Once published, playlists can be shared to the unit via USB or network connection.

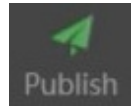

PUBLISH VIA USB

1. Insert a USB into your PC. In ViPlex Express Solutions tab, select solution, then click the USB Playback button to open the USB Playback window.

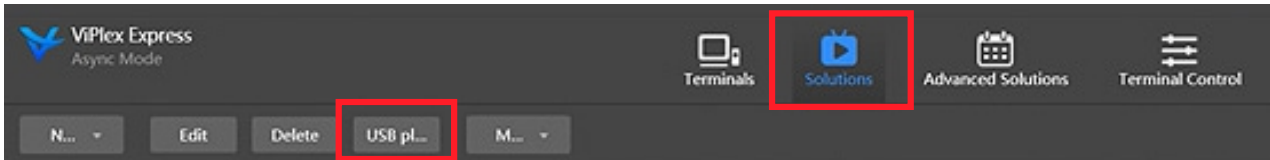

USB Publishing has 2 options: Copy and Play, and Plug and Play.

- **Copy and Play:** plug USB to copy the playlist to the unit. The playlist will loop play with or without USB in. You must select [Overwrite] for this option
- **Plug and Play:** Plug USB to play; remove USB to stop.

2. In Path, select your USB in the file browser pop up window. Click OK.

3. In terminal password, enter the unit password.

NOTE: the default password is **123456**

4. Click OK to finish publishing to USB.

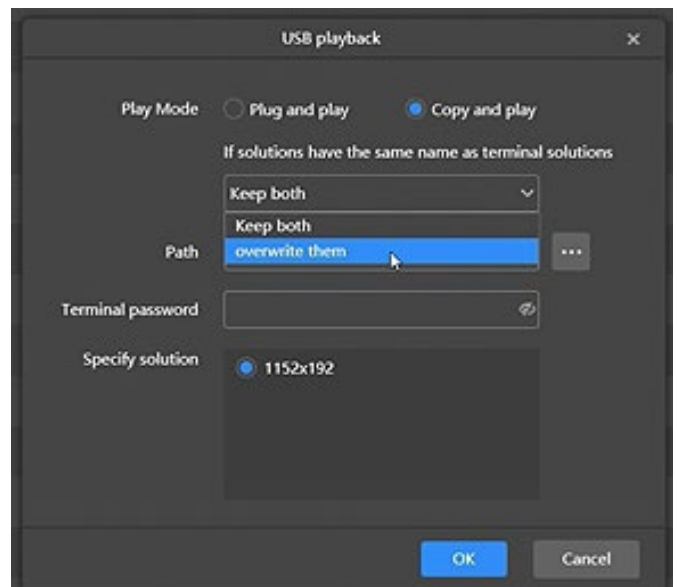

PUBLISH VIA NETWORK CONNECTION

To publish to the unit, click the Publish icon. The Publish window appears.

Select unit from Terminal Name list. Click Refresh if unit does not appear listed right away. Then, click Publish.

Connect to the unit's network to play solution (see next page for more).

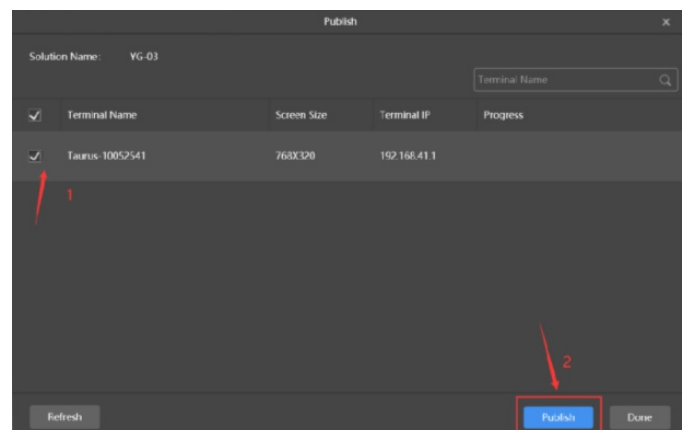

Unit Connection Methods

CONNECT WIRELESSLY

1. Open Wi-Fi settings on your PC and find the unit IP address. The unit's IP address is "AP" followed by the product ID number, which can be found on the inside of the unit access door.
2. Enter the default network password: 12345678

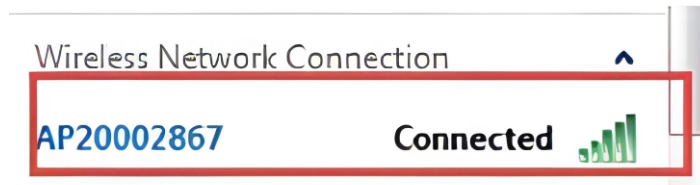

CONNECT VIA ETHERNET

Insert Ethernet cable into Ethernet (RJ45) port of unit, then connect Ethernet to PC.

CONNECT VIA USB

Publish solution to USB in ViPlex Express (see previous page for instructions). Then, insert USB into USB port of unit. The solution plays automatically.

CONNECT VIA MOBILE PHONE

The ViPlexHandy mobile app allows you to display solutions you've created in ViPlex Express. To download the app to your mobile phone, scan the QR code below or search ViPlexHandy in your app store. Or, download from the official website: <https://www.novastar.tech/downloads>.

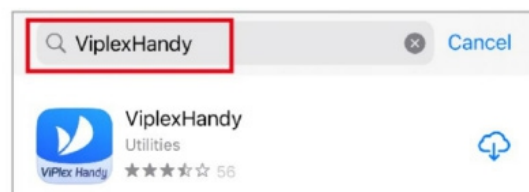

1. Disconnect PC and other devices before connecting on mobile app.
2. Open your phone's Wi-Fi settings on the phone and connect to the unit's IP address. The unit's IP address is "AP" followed by the product ID number, which can be found on the inside of the unit access door.
3. Enter the default network password: 12345678

REFERENCE

Technical Specifications

PANEL	LED Size	160(W) x 320(H)
	Light Source	NationStar 1415
	Resolution	320(W) x 512(H)
	Brightness	~ 4500nits
	Contrast	3000:1
	Response	12ms
	Pixel Pitch	P2.5
	Refresh Rate	≥1920
	Viewing Angle	140°/120°
	Color Saturation	N/A
	Viewable Area	800(W) x 1280(H)
	Chromaticness	14BIT
POWER SUPPLY	Voltage	AC 90-132V
	Power Consumption	About 850W
ENVIRONMENT	Operating Temperature	32 - 113 °F (-10-45 °C)
	Storage Temperature	-4 - 140 °F (-20-60 °C)
	Operating Humidity	10% - 80% RH Non-condensing
	Storage Humidity	0% - 90% RH Non-condensing
	Max. Operating time	7/24 hours
FUNCTIONS	Operating System	Android 11
	Processor	Quad-core ARM A55 processor @1.8 GHz 5W (x2)
	RAM	1G
	ROM	16G
	Decoding Resolution	4K
	Playback mode	Asynchronous Playback
	Touch Support	No
	Supported Video Files	AVI, MKV, MP4, MOV, 3GP, FLV, WMV, TS
	Supported Image Files	JPG, JPEG, BMP, GIF, PNG, WEBP
	Supported Audio Files	MP3
	RTC (Real-time clock)	Yes
	Schedule Power On/Off	N/A
	System Update	Manually
App Installation	N/A	

	Ethernet (RJ45)	1
	HDMI	N/A
	USB	1
	Wi-Fi	Yes
	Type-C OTG	N/A
	SIM	N/A
STRUCTURE	Net Weight	About 198lbs (~90kgs)
	Gross Weight	About 352lbs (~160kgs)
	Unit Dimensions	32.7" x 33.5" x 71" (831 x 850 x 1800mm)
	Screen Package Dimensions	77.5" x 44.5" x 21" (1967 x 1131 x 540mm)
	Base Package Dimensions	43" x 41" x 10" (1100 x 1040 x 258mm)
	Shell Material	Steel
	Shell Color	Black
LANGUAGE	OSD	English

Cleaning and Maintenance

- Avoid strong vibration or impact on the product.
- Keep the product dry to avoid possible damage by moisture.
- Don't place the product under direct sunlight which may shorten the service life of the screen.
- Clean screen and product by using a glass cleaner.
- If the product will not be used for a long time, unplug power cord to prevent internal short circuit or other potential dangers.

Troubleshooting Guide

ISSUE	PROBABLE CAUSE	SOLUTION
SCREEN IS BLACK	<ul style="list-style-type: none"> • Display power is not on. • Abnormal electrical power supply of display. • No video source is switched (synchronous or asynchronous) 	<ul style="list-style-type: none"> • Check the power supply to make sure the unit is powered. • Check if unit has been turned on. • Check Ethernet cable connection
IMAGES OUT OF SEQUENCE, REPEATING, OR NOT DISPLAYING PROPERLY	<ul style="list-style-type: none"> • Setting Error 	<ul style="list-style-type: none"> • Reload display configuration files
CANNOT UPLOAD CONTENT	<ul style="list-style-type: none"> • Content format is not compatible. • Content files are too large. • Port being used is defective • App used to play content is defective • Android board is defective. 	<ul style="list-style-type: none"> • Confirm content is one of the following compatible formats: AVI, MPEG4, WMV, MKV, flv, MP3, MP4, MOV. • Confirm file size is less than available space.
PARTS MISSING OR DAMAGED	<ul style="list-style-type: none"> • Parts missing from product • Parts damaged by operator 	<ul style="list-style-type: none"> • Contact a customer service representative for parts missed during manufacturing. (No charge for replacements) • Contact a customer service representative for Parts lost or damaged by the customer. (There is charge for replacements)

! **NOTE:** Do not attempt to replace or repair circuitry yourself. Contact customer service to schedule a professional maintenance appointment.

If all the potential solutions have been tested for a particular issue and problems have not been resolved, contact a customer service representative for guidance.

844-221-3388

info@displays2go.com

Names and Contents of Toxic and Hazardous Substances or Elements in the Product

The table shows that the machine contains harmful substances inside. The data is provided by material suppliers and verified by the company according to the material type. Some materials contain harmful substances that can't be replaced in present technology. We are dedicated to improving this.

O: the content of the toxic and hazardous substances or elements in the part is lower than the limit specified in GB/T 26572-2011 standard.

×: the content of the toxic and hazardous substances or elements in the part is higher than the limit specified in GB/T 26572-2011 standard.

PART NAME	TOXIC AND HAZARDOUS SUBSTANCES OR ELEMENTS					
	Pb	Hg	Cd	Cr ⁶⁺	PBB	PBDE
Display		O	O	O	O	O
Shell	O	O	O	O	×	×
Circuit Board Assembly *		O	O	O	O	O
Wires	O	O	O	O	O	O
Metal Parts	O	O	O	O	O	O
Packaging Materials*	O	O	O	O	O	O
Remote Control		O	O	O	O	O
Speakers		O	O	O	O	O
Accessories*	O	O	O	O	O	O

*: Packaging materials include packaging box, styrofoam, etc.;

*: Circuit board assembly includes PCB and the electronic elements thereof;

*: Other accessories include instruction manual.

The EFUP of the product is ten years. The pollution control label is shown right.



The EFUP is valid only when the user operates in the normal conditions specified in the manual herein.

Waste Electrical and Electronic Products Recycling and Disposal Regulations

To protect the earth, if you do not need this product or its service life expires, please abide by your local Waste Electrical and Electronic Products Recycling and Disposal Regulations or send it to qualified local manufacturer for recycling.

FCC Statement

Changes or modifications not expressly approved by the party responsible for compliance could void the user's authority to operate the equipment.

This equipment has been tested and found to comply with the limits for a Class B digital device, pursuant to Part 15 of the FCC Rules. These limits are designed to provide reasonable protection against harmful interference in a residential installation. This equipment generates uses and can radiate radio frequency energy and, if not installed and used in accordance with the instructions, may cause harmful interference to radio communications. However, there is no guarantee that interference will not occur in a particular installation. If this equipment does cause harmful interference to radio or television reception, which can be determined by turning the equipment off and on, the user is encouraged to try to correct the interference by one or more of the following measures:

Reorient or relocate the receiving antenna.

Increase the separation between the equipment and receiver.

Connect the equipment into an outlet on a circuit different from that to which the receiver is connected.

Consult the dealer or an experienced radio/TV technician for help

This device complies with part 15 of the FCC rules. Operation is subject to the following two conditions (1) this device may not cause harmful interference, and (2) this device must accept any interference received, including interference that may cause undesired operation.

FCC Radiation Exposure Statement

This equipment complies with FCC radiation exposure limits set forth for an uncontrolled environment. This equipment should be installed and operated with a minimum distance of 8 inches (20cm) between the radiator and your body.