



**DISPLAYS2GO**  
CONNECTING PEOPLE & BRANDS WITH THE WORLD

---

# 21.5 Digital Literature Holder 11

## USER MANUAL

SKU: DL215NLB



**FCC ID: 2ASCB-DL215**

This device complies with Part 15 of the FCC Rules. Operation is subject to the following two conditions:

- (1) this device may not cause harmful interference, and
- (2) this device must accept any interference received, including interference that may cause undesired operation.

Any changes/modifications to this equipment not approved by the party responsible for compliance could void the user's authority to operate the equipment.



---

# Thank you for purchasing this product from Displays2go.

It's our mission to help you connect with the world and build your brand with products that are personalized to your needs.

Your product has been manufactured with great care using only the finest quality materials and expert workmanship. Our Quality Assurance team inspects all electronics during assembly process to assure reliable operation. This product comes with a 12-month warranty. Scan the QR code to visit the product page and learn more about your warranty.

**Need assistance?** We are available for expert advice and all of your customer service needs.



---

# TABLE OF CONTENTS

## Before Use

Safety and Warnings	4
Packing List	7
Interface Diagram	7
Assembly	8

## Operation

Power On/Off	9
Remote Control	9
Navigation	10
Android 11 Quick Start Guide	10
DiViEX	11

## Reference

Technical Specifications	14
Cleaning and Maintenance	15
Troubleshooting Guide	16
Names and Contents of Toxic and Hazardous Substances or Elements in the Product	18
FCC Compliance Notice	19



# BEFORE USE

## Safety Warnings and Precautions

Thank you for purchasing the high-performance multi-functional LED backlight Digital Signage from Displays2Go. We have considered the factors to ensure personal safety in product design and have tested rigorously at the factory. However, improper installation and use may result in electric shock and fire.

In order to safely use, maximize performance of the unit and extend the life of the product, please read and follow all instructions carefully before using the product. Keep the instructions for future reference.

**We strongly recommend using a surge protector, or a power strip with internal circuit breaker to prevent damages to the digital signage.**

	<b>Warning:</b> May cause personal injury or death
	The operation is prohibited
	<b>Caution:</b> May cause damage or property loss

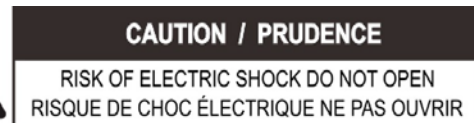

*If any of the following occurs:*

- Power outage or instable voltage.
- Abnormal sound or smell from the unit.
- AC power cord is damaged.
- Digital Signage is damaged due to drop, knock or impact.
- Any liquid or foreign matters fall into the enclosure.



Turn off the Digital Signage immediately, pull out the plug from the power outlet, and ask the authorized personnel for maintenance timely.



If coal gas or other flammable gas leaks, do not pull out the plug of the LCD digital signage or other electrical appliances; instead, turn off the gas valve immediately, and open the doors and windows quickly.



## WARNING



- Cut off the power supply before connecting or disconnecting any cables.
- Do not place the Digital Signage on any instable positions, or else it may be damaged or cause fire.
- Do not place the Digital Signage in the positions such as:
  - The environment subject to direct strong sunlight, moisture, extreme temperature or too much dust,
  - The environment with flammable or explosive materials,
  - The environment with flammable or corrosive gases,
- Do not use damaged or inappropriate power outlets, and ensure that the plugs and outlets contact properly.
- Do not let dust or metal deposits adhere to the plugs and outlets.
- Do not damage the power cords:
- Do not modify the power cords,
- Do not place heavy objects on the power cords,
  - Keep the power cords away from heat source,
  - Do not pull the cord to remove the plug.
  - Do not connect too many plugs to one outlet in parallel, or else it may cause fire due to excessive power consumption.
- Do not approach the Digital Signage with open flame (e.g. a lighted candle), or else it may cause electric shock or fire.
- Do not put any sharp objects, metal or liquid into the vents or let them touch the signal terminals to avoid short circuit, product damage, and electric shock.
- The openings in the enclosure are designed for ventilation and cooling, to ensure long time reliable running of components inside the enclosure and prevent overheating. Do not block the openings when place the unit.



Do not touch the plugs with wet fingers, or else it will cause electric shock.



Do not use the Digital Signage in stormy weather, especially when there is lightning, instead, please disconnect the power and antenna plugs to avoid lightning strike.



Do not disassemble the Digital Signage without permission, or else it may cause electric shock or fire. Please ask qualified technician for repair.



## CAUTION

- Do not let children climb onto the Digital Signage.
- Keep the small parts away from children to prevent them from swallowing.
- If the Digital Signage won't be used for a long time, please turn it off and pull out the power plug.
- To adjust the position of the Digital Signage, please disconnect all power cords and move slowly to avoid tip over.
- Do not scratch or knock the LCD with hard object, or twist and squeeze the LCD.
- Do not turn on the unit immediately when it is moved from a place with low temperature to high temperature, or else it will cause condensation and malfunction.
- Before cleaning the Digital Signage, please pull out the power plug, wipe with soft cloth, do not use industrial chemicals, prevent foreign matters from entering the machine. Improper cleaning (such as cleaning solution, water) may damage the product, erase the printed information, and even cause damage of the components if fluid flows in, resulting in machine failure.
- If the unit displays the same screen for a long time or the moving picture has fixed text or icon, it will leave ghosting on the screen and won't disappear when the unit is turned off, it is normal and isn't covered by the warranty.
- The power of the Digital Signage can be cut off by pulling out the plug.
- If the LCD screen ruptures and the liquid splashes on the skin, please rinse for 15 minutes with clean water immediately, and consult your doctor.
- To carry the Digital Signage with hands, please grab and hold the edges, do not apply pressure on the panel.
- Use the Digital Signage properly: Use in proper lighting conditions, insufficient lighting or long time watching will impair your eyesight.
- Unplug device to disconnect from power.
- Insert the plug into the outlet properly, or else it may cause sparks and fire.

The technical specifications printed herein and on the packaging are subject to change without prior notice. The Manual may be slightly different from actual operation, and the latter is applicable.

Contact Displays2go if you have questions about the operation, debugging and connection of the unit, if the unit doesn't work normally, please cut off the power immediately and consult the dealer. The unit is class-A product, which may cause radio interference in living environment. In this case, please take feasible measures, and use power plug as the disconnection device.

# Packing List

Item	Quantity
Digital Signage	1
Power Cord	1
Wi-Fi Antenna	1
Remote Control	1
Cleaning Kit Towel and Glove	1
User Manual	1

Base Screw Package	Quantity
Hex Wrench	1
M8 x 25 Screws	6
Washers	6

Wheel Screw Package	Quantity
Casters	4
Cross Screwdriver	1
M6x12Cross head pad screw	16

# Interface Diagram

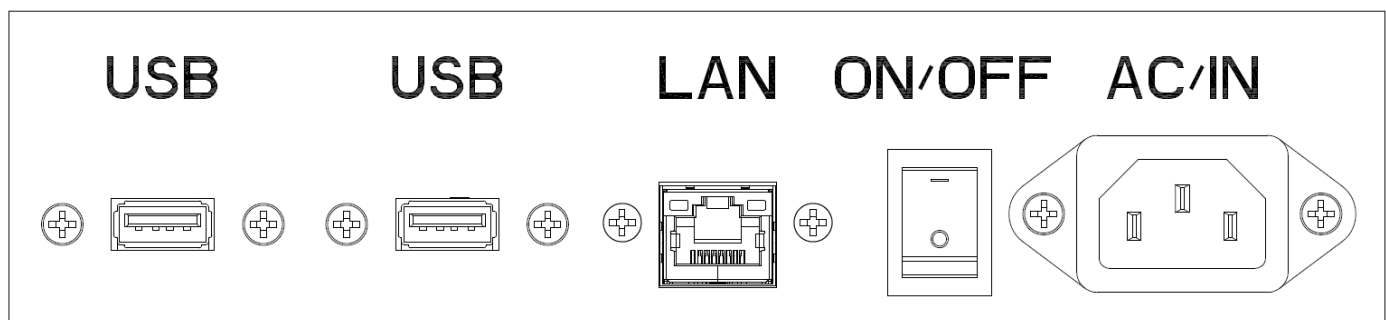

Name	Quantity
USB Port	2
LAN	1
On / Off Switch	1
AC 100-240V	1

If you have any questions regarding our products, please visit us at [www.displays2go.com](http://www.displays2go.com) or contact Displays2go customer service at 844-221-3388.

# Assembly

**!** NOTE: Two people required for safe assembly of product. Always unplug power cord before installing or disassembling the unit!

## UNPACKING

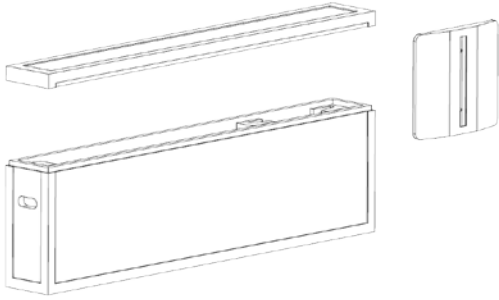

Open the top cover. Remove base from package and carefully set aside.

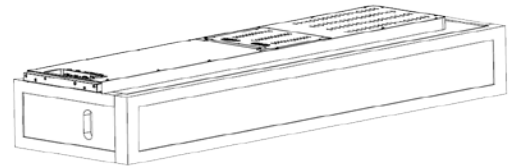

Have 2 people carefully remove unit from the package. Set it down on the shipping box to avoid scratches.

1

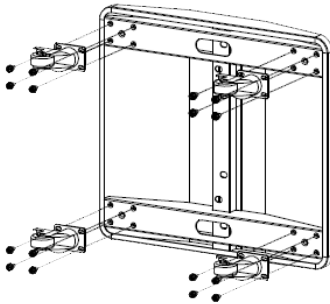

Flip base over. Insert caster posts into corresponding base slots. Screw hex screws into the 4 screw holes for each caster. Tighten all screws with cross screwdriver.

2

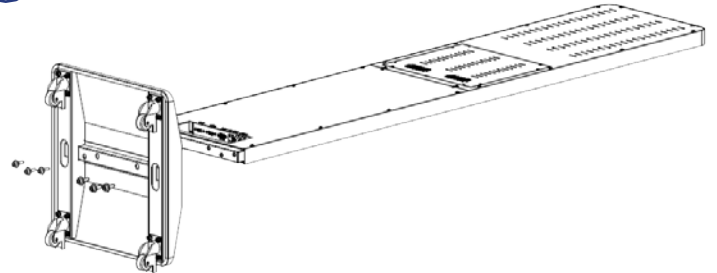

Have one person slightly tip the unit upward. Attach base to unit using hex screws. Tighten all the base screws with hex wrench.

3

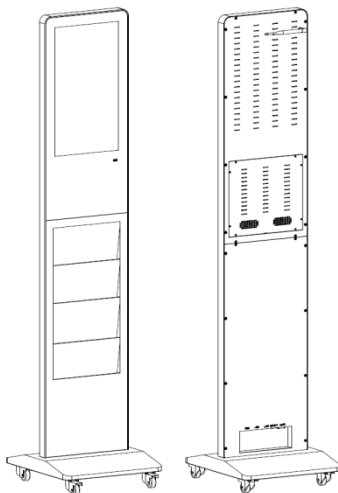

Have 2 people carefully lift into the standing position. Screw antennas into antenna receivers on top of the unit.

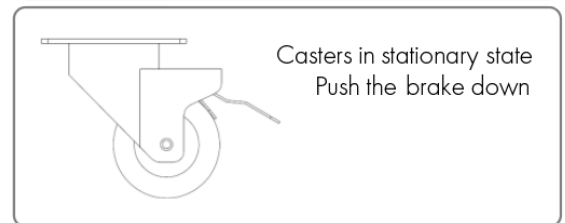
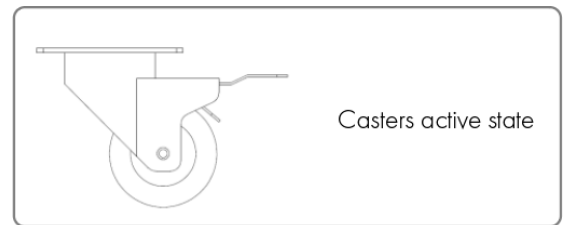

**!** NOTE: Casters can be locked for safety.



# OPERATION

## Power On/Off

**!** **NOTE:** We recommend using a surge protector or power strip with internal circuit breaker to prevent potential damages to the product.

- **Power on** by inserting the power cord into unit and connecting to outlet. Flip I/O switch to “I” position.
- **To turn the screen on or off**, press the  power button on the remote control.
- **To shut down**, flip I/O switch to “O” position, then unplug the unit.

## Remote Control

To control the unit, aim the remote control at the unit’s receiver, located at the right corner below the screen. For best performance, avoid exposing the receiver window to direct sunlight or placing objects between the remote control and the receiver.

**!** **NOTE:** For convenient navigation, we recommend connecting an external mouse via USB input or Bluetooth connection.

The real appearance of the remote control may be different from the picture, please refer to the actual product.

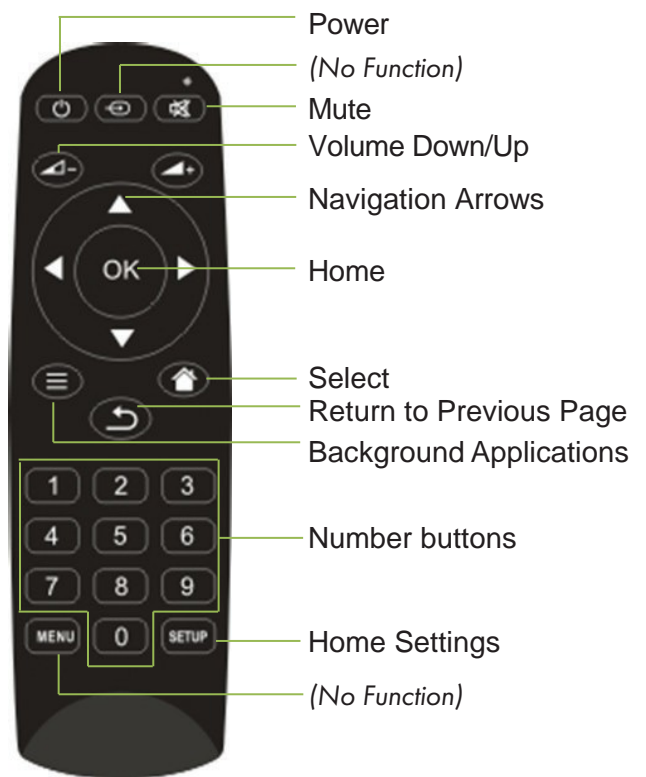

# Navigation

Once turned on, the unit automatically displays the home screen, which includes the navigation bar and the App Drawer.

**NOTE:** The Navigation bar can be minimized. To restore the navigation bar, go into Display settings and enable Display Navigation.

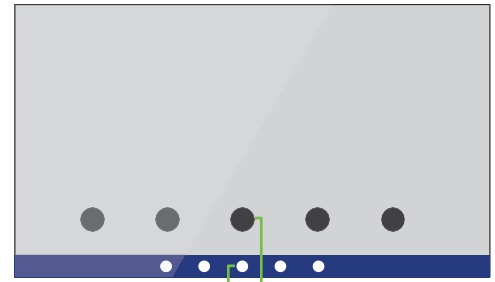
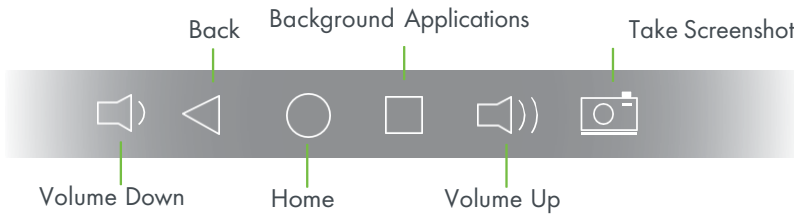

**App Drawer**  
Shows all apps

**Navigation Bar**  
Enlarged view left



## ANDROID 11 QUICK START GUIDE

Adjust settings by tapping the App Drawer, and launching the Settings app.

### WI-FI CONNECTION



1. Open **Settings**, and select **Network and Internet** from the list of settings.
2. Select your Wi-Fi network and enter your login credentials. Click **Okay**.

**For Ethernet Connections**, plug an ethernet cable into the ethernet (RJ45) port of the unit and connect to internet router. Ethernet network connection is complete.

### BLUETOOTH



1. Open **Settings**, and select **Connected Devices**.
2. Click **Pair New Device**. Make sure your Bluetooth device is in pairing mode.

For future connections, select the device from the list of previously connected Bluetooth devices.

**NOTE:** To share files over Bluetooth, you must enable Wi-Fi and Bluetooth Scanning in the Location settings.

### SOUND



1. Open **Settings**, and select **Sound**.

From this menu, you can individually control the volume of alarms, calls, notifications, and your media.

You can also change default notification sounds or turn Do Not Disturb on or off.

### SYSTEM LANGUAGE



1. Open **Settings**, and select **System**.
2. Click **System Language**, then click **Languages**.
3. Click **+ Add a language** and select a language. It appears as the 2nd installed system language.
4. Drag your preferred system language to first position of the list. The system language updates automatically to the first listed language.

### SCREENSHOTS



1. Open **Settings**, and select **Screenshot**.
2. Adjust the screenshot delay and enable or disable the Screenshot button in the navigation bar.

Find recent screenshots in the **Google Files** app. Choose the unit, click **Pictures**, then click **Screenshots**.

### FACTORY RESET



1. Open **Settings**, and select **System**.
2. Select **Advanced Options**.
3. Click **Reset Options**.
4. Select **Erase All Data (Factory Reset)**. Then click **Erase All Data**.





Our DiViEX Slideshow App comes pre-installed on this digital product to provide convenience for your business content management. Easily upload your videos and images to a USB and insert into the unit. Then, open the app to launch a slideshow or adjust picture settings, add filters and stickers, queue music and more!

## Add Media to USB

1. Insert your USB drive into your computer. Create a new folder and name it 'MediaFolder'.
2. In 'MediaFolder,' create 3 subfolders. Rename them: "Images"; "Videos"; "Music".
3. Copy your desired images, videos, and music to the corresponding folder.
4. Copy 'MediaFolder' to USB and safely eject USB from computer.

> MediaFolder

Name

-  Images
-  Music
-  Videos

5. Insert USB into the unit. Open the DiViEX app.



## SUPPORTED FILE FORMATS

<b>IMAGE</b>	JPG, JPEG, BMP, PNG, GIF
<b>VIDEO</b>	AVI, MPEG4, WMV, MKV, FLV, MP4, MOV
<b>AUDIO</b>	MP3

- !** NOTE: If DiViEX stops running after pressing play, check:
- 'MediaFolder' is set up correctly on the USB.
  - All files in 'MediaFolder' are the supported file formats.

# PLAYLIST SETTINGS

Edit the overall playlist settings in the **Settings** tab. Once settings are adjusted, click **PLAY** or adjust further in the Edit or Music tab.

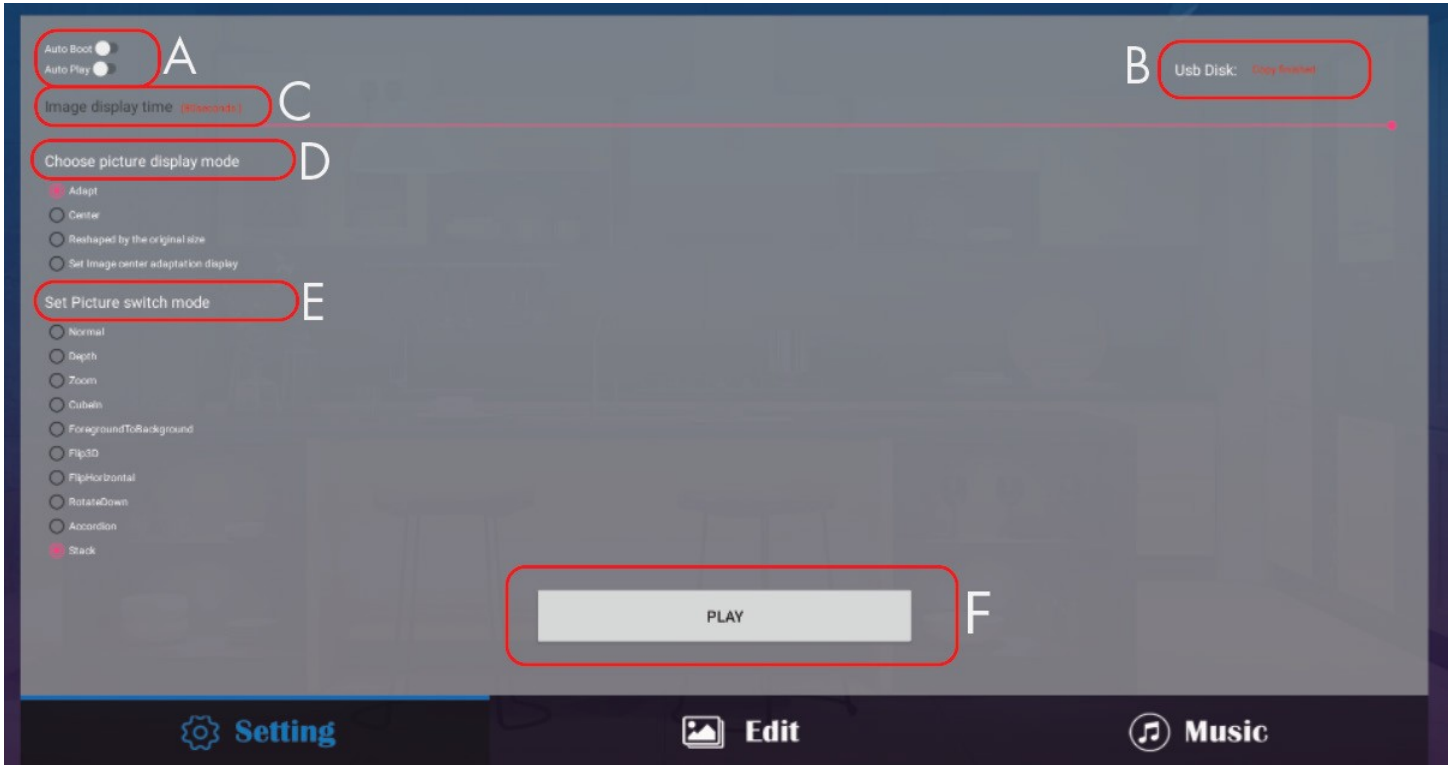

<p><b>A. AUTOMATIC SETTINGS</b></p>	<p>Enable or disable automatic settings.</p> <p><b>Auto-Boot:</b> Automatically launch DiViEX when unit is powered on</p> <p><b>Auto-Play:</b> Automatically play slideshow when DiViEX opens</p>
<p><b>B. USB DISK STATUS</b></p>	<p>Status of file transfer from 'MediaFolder' on USB.</p>
<p><b>C. IMAGE DISPLAY TIME</b></p>	<p>How long each image is shown. Drag slider to increase or decrease.</p> <p><b>NOTE:</b> Does not apply to video</p>
<p><b>D. PICTURE DISPLAY MODE</b></p>	<p>Choose how each image/video fits on the screen.</p> <p><b>Adapt:</b> Crop image to screen</p> <p><b>Center:</b> Center image regardless of aspect ratio.</p>
<p><b>E. PICTURE SWITCH MODE</b></p>	<p>Choose animated transition effect for slideshow.</p>
<p><b>F. PLAY</b></p>	<p>Play playlist with selected settings.</p>

# EDIT

Tweak each photo individually in the Edit tab.

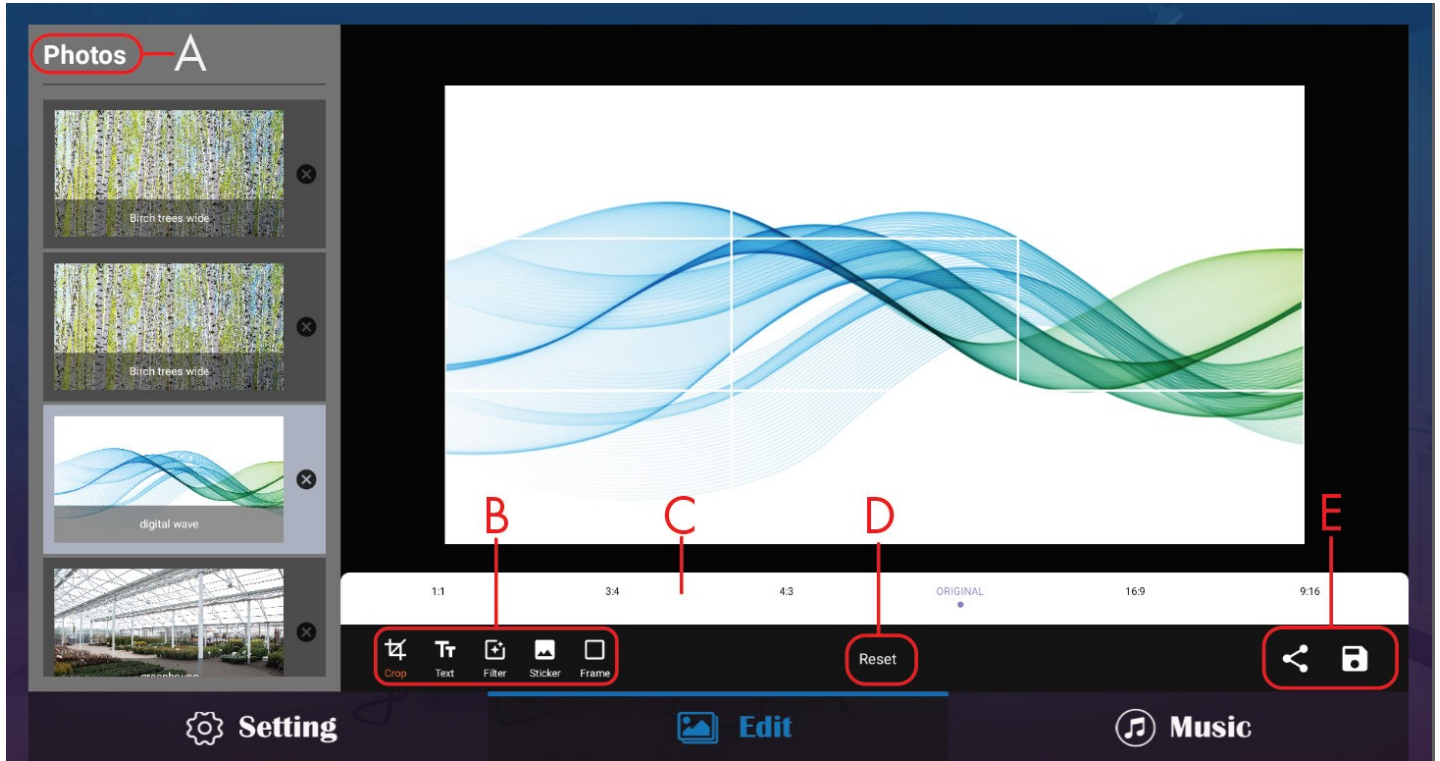

<b>A. PHOTOS</b>	Images/Video thumbnails in sequential order. Drag to rearrange.
<b>B. EDIT TOOLS</b>	Crop, Add Text, Add Filter, Add Sticker, Add Frame
<b>C. TOOLBAR</b>	This white bar shows tool options for each of the Edit tools. Choose aspect ratios when cropping, adjust text, and scroll to select stickers, frames, and filters.
<b>D. RESET</b>	Reset all edits
<b>E. SAVE / SHARE</b>	Save progress or share playlist. After saving, go back to Settings tab and press PLAY.

# MUSIC

Choose music from the Music folder to play during slideshow. Press the left arrow (F) to add music to the slideshow playlist. Press the right arrow (G) to remove songs from the playlist. The number of songs in the playlist is shown in the upper left.

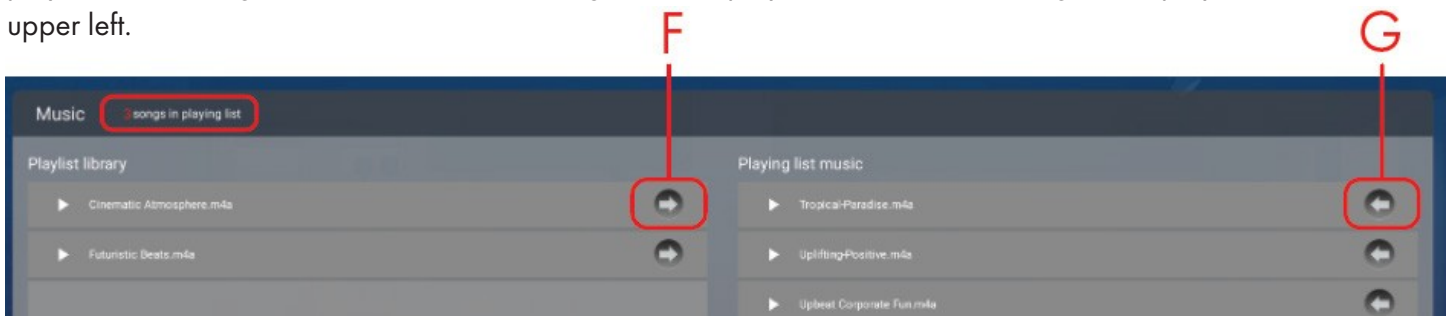

# REFERENCE

## Technical Specifications

<b>PANEL</b>	LCD Size	21.5"
	Light Source	LED backlight
	Resolution	1920*1080 (pixels)
	Brightness	500cd/m2
	Contrast	1000: 1
	Response	14ms
	Pixel Pitch	0.25 (H) * 0.25 (V) mm
	Refresh Rate	60Hz
	Viewing Angle	178° (H)/178° (V)
	Color Saturation	73%
	Viewable Area	476.1 (H) * 267.8(V) mm
	Chromaticness	16.7M
<b>POWER SUPPLY</b>	Voltage	100V~240V, 50-60Hz
	Power Consumption	≤35W
<b>ENVIRONMENT</b>	Operating Temperature	32°F ~ 104°F (0~40°C)
	Storage Temperature	14°F ~ 140°F (-10~60°C)
	Operating Humidity	20~80% RH Non-condensing
	Storage Humidity	10~60% RH Non-condensing
	Max. Operating time	18 hours per day
<b>FUNCTIONS</b>	Operating System	Android 11
	Processor	RK3568, quad-core
	RAM	4 GB
	ROM	32 GB
	Decoding Resolution	1920 x 1080
	Playback mode	Support loop, inter-cut, timer, shim, etc.
	Speakers	10Wx2
	Touch Support	No touch
	Supported Video Files	AVI, MPEG4, WMV, MKV, FLV, MP4, MOV
	Supported Image Files	JPEG, BMP, PNG, GIF
	Supported Audio Files	MP3
	RTC (Real-time clock)	Yes
	Schedule Power On/Off	Yes
System Update	USB Compatible	

	App Installation	Support download and installation
<b>I/O INTERFACES</b>	TF	N/A
	Ethernet (RJ45)	1
	HDMI	N/A
	VGA	N/A
	3.5mm headphone	N/A
	USB	2
	Wi-Fi	1
	Type-C OTG	N/A
	SIM	N/A
<b>STRUCTURE</b>	Net Weight	49lbs (22kg)
	Gross Weight	68lbs (31kg)
	Unit Dimensions	14" x 1.6" x 66" (351x40x1680mm)
	Package Dimensions	70" x 8.3" x 21" (≈1783x210x532mm)
	Shell Material	Aluminum profile/sheet metal
	Shell Color	Black/White
<b>LANGUAGE</b>	OSD	English/Simplified Chinese

## Cleaning and Maintenance

- Avoid strong vibration or impact on the product.
- Keep the product dry to avoid possible damage by moisture.
- Don't place the product under direct sunlight which may shorten the service life of the screen.
- Use a glass cleaner to wipe product and screen.
- If the product will not be used for a long time, pull out the power cord to prevent internal short circuit or other potential dangers.

# Troubleshooting Guide

ISSUE	PROBABLE CAUSE	SOLUTION
<b>NO PICTURE OR SOUND</b>	<ul style="list-style-type: none"> <li>Unit not plugged into wall outlet</li> <li>Power cord not properly connected to the terminal on the back of the unit.</li> <li>Unit not powered on</li> <li>Wall outlet not working</li> </ul>	<ul style="list-style-type: none"> <li>Check that the unit is plugged into wall outlet.</li> <li>Confirm that the power cord is connected to the terminal on the back of the unit.</li> <li>Turn the on/off toggle switch located on the back of the unit, lower center, to the "on" position.</li> <li>Unplug unit, wait 20 seconds, plug unit back into outlet and try again.</li> <li>Make sure that outlet is working by plugging in a different electrical device.</li> </ul>
<b>NO SOUND</b>	<ul style="list-style-type: none"> <li>Volume not adjusted on the remote control.</li> <li>Content/Video does not have sound.</li> <li>Content format is not compatible.</li> <li>Speakers do not work.</li> </ul>	<ul style="list-style-type: none"> <li>Adjust volume using the remote control</li> <li>Confirm content is one of the following compatible formats: AVI, MPEG4, WMV, MKV, flv, MP3, MP4, MOV.</li> <li>If unit is connected to Wi-Fi, go to YouTube and play video that has sound</li> <li>Unplug unit, wait 20 seconds, plug unit back into outlet and try again.</li> <li>Try playing the content on a different device (smart phone, computer or tablet)</li> </ul>
<b>NO PICTURE</b>	<ul style="list-style-type: none"> <li>Content file damaged.</li> <li>Content format is not compatible.</li> <li>Screen damaged or defective.</li> </ul>	<ul style="list-style-type: none"> <li>Confirm content is one of the following compatible formats: AVI, MPEG4, WMV, MKV, flv, MP3, MP4, MOV.</li> <li>Try playing the content on a different device (smart phone, computer or tablet)</li> <li>Unplug unit, wait 20 seconds, plug unit back into outlet and try again.</li> </ul>
<b>REMOTE CONTROL NOT WORKING</b>	<ul style="list-style-type: none"> <li>Batteries not inserted properly.</li> <li>Batteries are dead.</li> <li>Standing too close or too far from the unit.</li> </ul>	<ul style="list-style-type: none"> <li>Check that battery is inserted properly with positive and negative orientation.</li> <li>Insert new batteries.</li> <li>Stand within 1 foot of the front of the unit and point the remote directly at the sensor (green dot)</li> </ul>



<b>NO WI-FI SIGNAL</b>	<ul style="list-style-type: none"> <li>• Wi-Fi is not turned on in product settings.</li> <li>• Wi-Fi is not connected to a network</li> <li>• Low or no signal from the router</li> <li>• Antenna is missing or not pointed upward.</li> <li>• Damaged PC board</li> </ul>	<ul style="list-style-type: none"> <li>• Check that Wi-Fi is turned on in settings</li> <li>• Confirm that the antenna is in place and pointed upward.</li> <li>• Check that other devices are receiving the signal. If other devices are not receiving the Wi-Fi signal, please contact your internet service provider.</li> <li>• Unplug or reset the router and wait for 20 seconds. Restart the router and check.</li> </ul>
<b>PARTS MISSING OR DAMAGED</b>	<ul style="list-style-type: none"> <li>• Parts missing from product</li> <li>• Parts damaged by operator</li> </ul>	<ul style="list-style-type: none"> <li>• Contact a customer service representative for parts missed during manufacturing. (No charge for replacements)</li> <li>• Contact a customer service representative for Parts lost or damaged by the customer. (There is charge for replacements)</li> </ul>
<b>CANNOT UPLOAD CONTENT</b>	<ul style="list-style-type: none"> <li>• Content format is not compatible.</li> <li>• Content files are too large.</li> <li>• Port being used is defective</li> <li>• App used to play content is defective</li> <li>• Android board is defective.</li> </ul>	<ul style="list-style-type: none"> <li>• Confirm content is one of the following compatible formats: AVI, MPEG4, WMV, MKV, flv, MP3, MP4, MOV.</li> <li>• Confirm file size is less than available space.</li> </ul>
<b>PRE-INSTALLED APPS NOT WORKING</b>	<ul style="list-style-type: none"> <li>• 'MediaFolder' incorrectly set up</li> <li>• Software error</li> <li>• App is defective</li> <li>• Android board is defective</li> </ul>	<ul style="list-style-type: none"> <li>• Check that images, videos, and music are correctly stored in the 'MediaFolder' folder (see page 12).</li> <li>• Check that file has successfully transferred to USB and USB is functioning.</li> <li>• Contact Displays2go support.</li> </ul>

**!** **NOTE:** Do not attempt to replace or repair circuitry yourself. Contact customer service to schedule a professional maintenance appointment.

If all the potential solutions have been tested for a particular issue and problems have not been resolved, contact a customer service representative for guidance.

**844-221-3388**

**info@displays2go.com**

# Names and Contents of Toxic and Hazardous Substances or Elements in the Product

The table shows that the machine contains harmful substances inside. The data is provided by material suppliers and verified by the company according to the material type. Some materials contain harmful substances that can't be replaced in present technology. We are dedicated to improving this.

O: the content of the toxic and hazardous substances or elements in the part is lower than the limit specified in GB/T 26572-2011 standard.

×: the content of the toxic and hazardous substances or elements in the part is higher than the limit specified in GB/T 26572-2011 standard.

PART NAME	TOXIC AND HAZARDOUS SUBSTANCES OR ELEMENTS					
	Pb	Hg	Cd	Cr 6+	PBB	PBDE
Display		O	O	O	O	O
Shell	O	O	O	O	×	×
Circuit Board Assembly *		O	O	O	O	O
Wires	O	O	O	O	O	O
Metal Parts	O	O	O	O	O	O
Packaging Materials*	O	O	O	O	O	O
Remote Control		O	O	O	O	O
Speakers		O	O	O	O	O
Accessories*	O	O	O	O	O	O

\*: Packaging materials include packaging box, styrofoam, etc.;

\*: Circuit board assembly includes PCB and the electronic elements thereof;

\*: Other accessories include instruction manual.

The EFUP of the product is ten years. The pollution control label is shown right.



The EFUP is valid only when the user operates in the normal conditions specified in the manual herein.

## Waste Electrical and Electronic Products Recycling and Disposal Regulations

To protect the earth, if you do not need this product or its service life expires, please abide by your local Waste Electrical and Electronic Products Recycling and Disposal Regulations or send it to qualified local manufacturer for recycling.

# FCC Statement

Changes or modifications not expressly approved by the party responsible for compliance could void the user's authority to operate the equipment.

This equipment has been tested and found to comply with the limits for a Class B digital device, pursuant to Part 15 of the FCC Rules. These limits are designed to provide reasonable protection against harmful interference in a residential installation. This equipment generates uses and can radiate radio frequency energy and, if not installed and used in accordance with the instructions, may cause harmful interference to radio communications. However, there is no guarantee that interference will not occur in a particular installation. If this equipment does cause harmful interference to radio or television reception, which can be determined by turning the equipment off and on, the user is encouraged to try to correct the interference by one or more of the following measures:

Reorient or relocate the receiving antenna.

Increase the separation between the equipment and receiver.

Connect the equipment into an outlet on a circuit different from that to which the receiver is connected.

Consult the dealer or an experienced radio/TV technician for help

This device complies with part 15 of the FCC rules. Operation is subject to the following two conditions (1) this device may not cause harmful interference, and (2) this device must accept any interference received, including interference that may cause undesired operation.

## **FCC Radiation Exposure Statement**

This equipment complies with FCC radiation exposure limits set forth for an uncontrolled environment. This equipment should be installed and operated with a minimum distance of 8 inches (20cm) between the radiator and your body.