承 认 书

SPECIFICATION FOR APPROVAL

客户名称

CUSTOMER NAME:

产品名称

PRODUCT NAME: 2.4G\5.8G-5dBi 剑形 SMA 公头母针黑色天线

客户料号

CUSTOMER P/N:

公司料号

COMPANY P/N:

REV: A

	MANUFACTURER SIGNATURE	CUSTOMER SIGNATURE
CHECKED BY:		
APPROVED BY:		
DATE:	2015/11/14	

Contents

<i>Item</i>	<i>Description</i>
1.-----	规格表
2.-----	成品图
3.-----	测试报告
4、-----	SGS 报告

1. 规格表:

产品主要技术参数

主要技术指标		Main technical specifications	
频率范围 (MHZ)	2400\5800	Frequency Range (MHZ)	2400\5800
特性阻抗(Ω)	50	Impedance(Ω)	50
增益(dBi)	5 \pm 0.5	Gain(dBi)	5 \pm 0.5
输出电压 驻波比	\leq 1.92	VSWR	\leq 1.92
最大功率	10W	Admitted Power	10W
极化方式	垂直极化	Polarization	Linear, Vertical
连接方式	SMA	Connector Type	SMA
物理性能		Physical Properties	
天线本体材料	ABS	Antenna Base	ABS
工作温度	-20 $^{\circ}$ C~+65 $^{\circ}$ C	Operating Temp	-20 $^{\circ}$ C~+65 $^{\circ}$ C
保存温度	-30 $^{\circ}$ C~+75 $^{\circ}$ C	Storage Temp	-30 $^{\circ}$ C~+75 $^{\circ}$ C

2. 成品图:

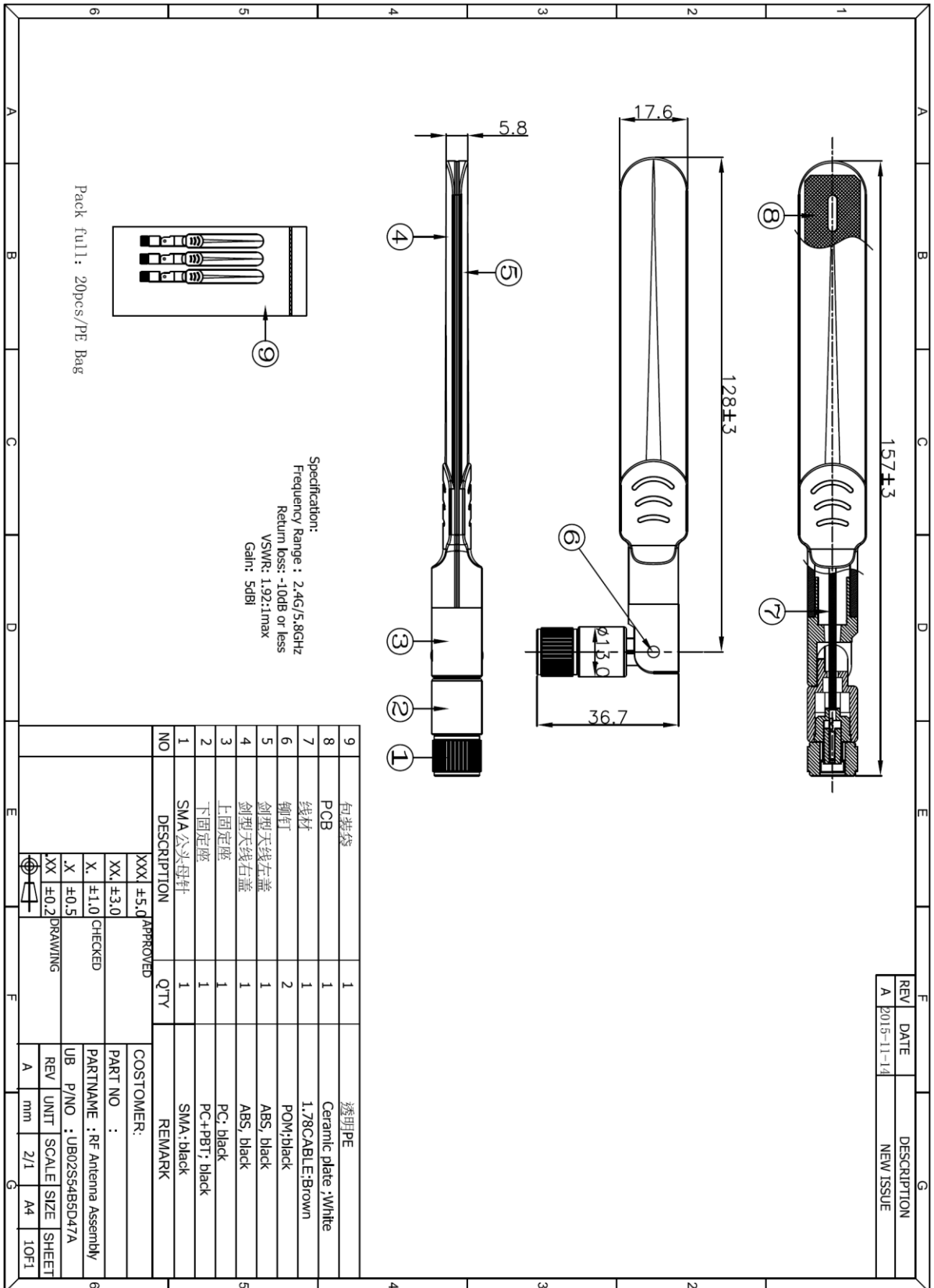

3. 测试报告

3.1: 网络分析仪测试报告:

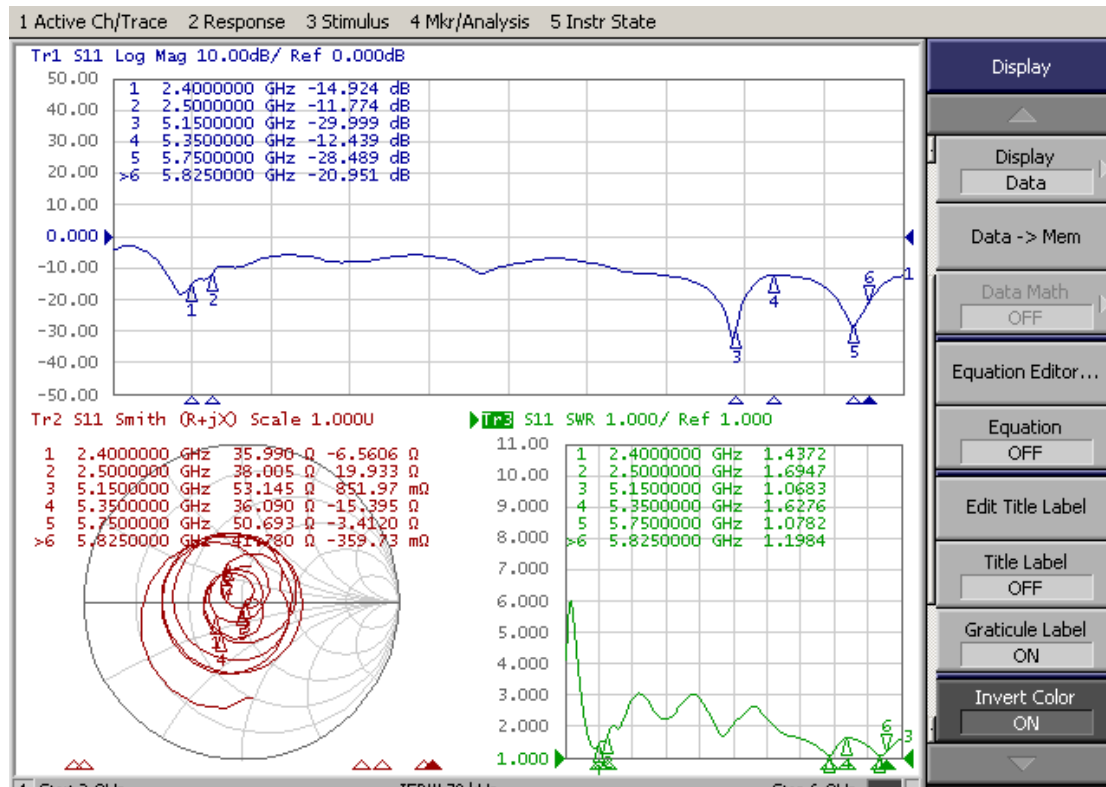

3.2: 暗室 2D、3DRaditation Pattern

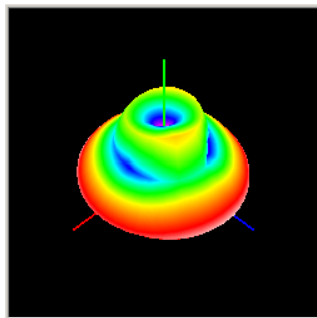

2.4GHz

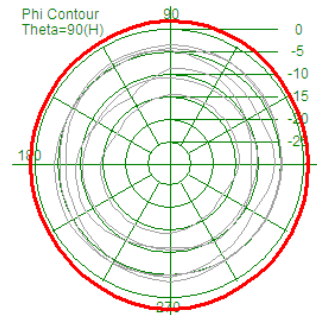

Gain: 4.83dBi

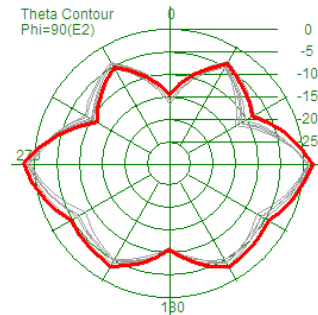

Efficiency: 71.38%

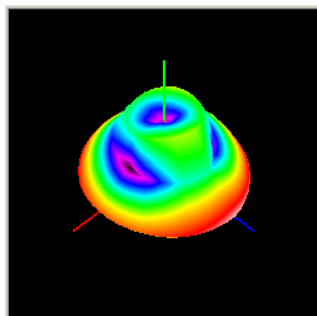

2.45GHz

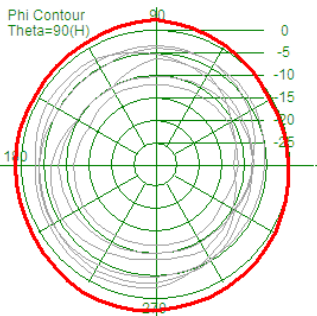

Gain: 4.85dBi

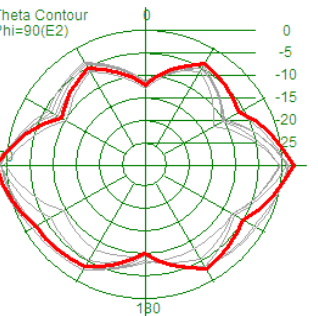

Efficiency: 71.56%

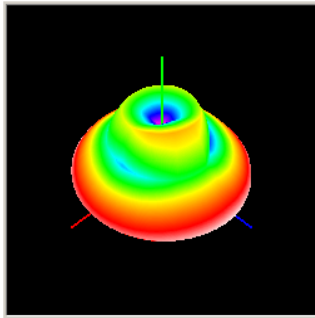

2.5GHz

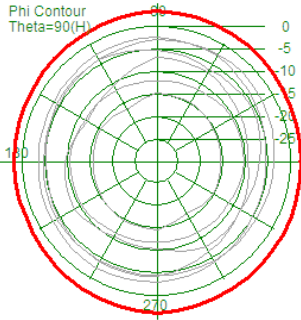

Gain: 4.92dBi

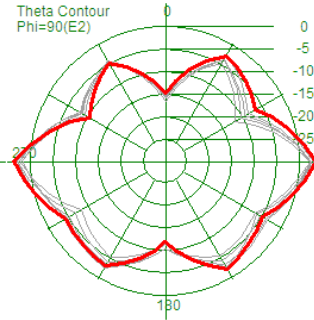

Efficiency: 72.19%

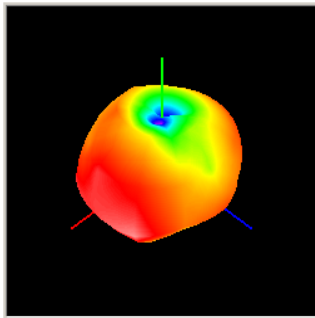

5.15GHz

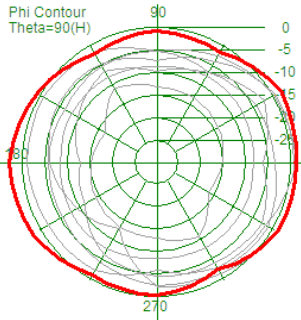

Gain: 5.06dBi

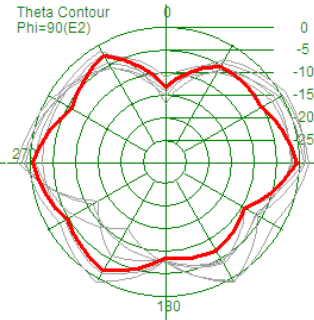

Efficiency: 73.34%

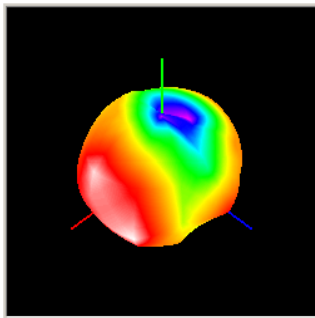

5.35GHz

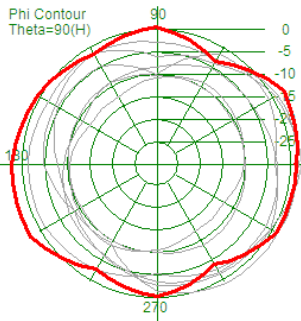

Gain: 5.17dBi

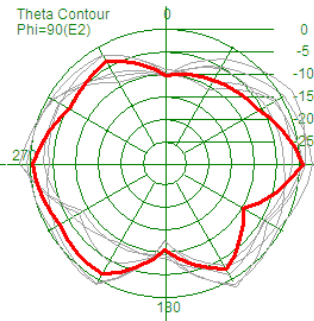

Efficiency: 73.23%

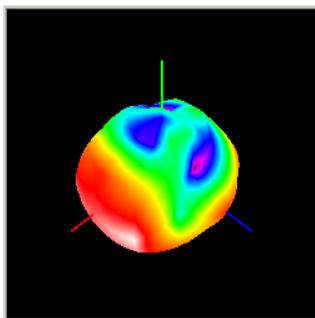

5.75GHz

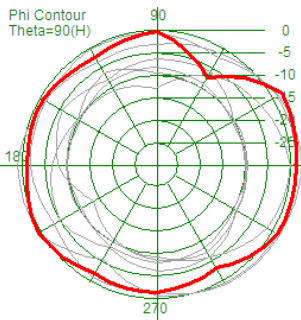

Gain: 5.21dBi

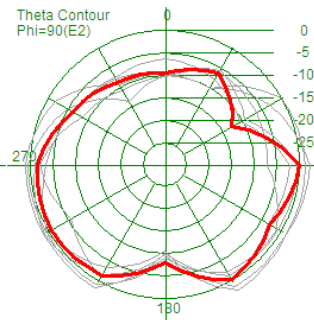

Efficiency: 74.18%

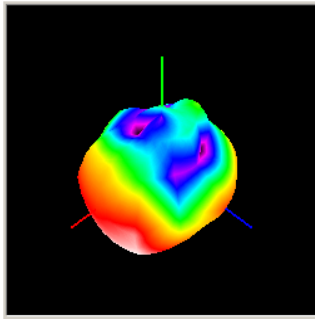

5.825GHz

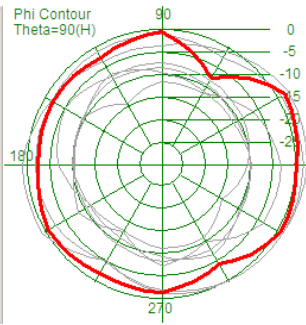

Gain: 5.28dBi

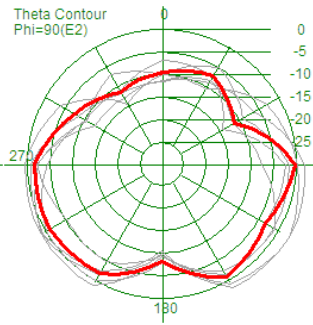

Efficiency: 75.25%

4.SGS 报告:

Verification Report

No. CANEC1216278501

Date: 07-Jan-2015

Page 1 of 20

Applicant : **DONGGUAN UB ELECTRONIC COMPANY LIMITED**
Address : **3-4 FLOOR,NUMBER 1 SOUTHWEST ROAD,SHEK KWU INDUSTRIAL ZONE TANGXIA**
TOWN,DONGGUAN CITY
CHINA

Sample Name : Transformer
SGS Job No. : CP12-056425 - SZ
Tested Basic Model No. UBXXXXXXXX
(P.O. No.) :
Date of Sample Received : 29 Nov 2014
Verification Period : 29 Nov 2014 -07 Jan 2015
Verification Requested : With reference to RoHS Directive 2011/65/EU, and its amendment directives
Verification Method : Please refer to next page(s).
Verification Result : Please refer to next page(s).
Verification Conclusion : Based on the review of previous reports and verification results of the submitted samples, the results of Cadmium, Lead, Mercury, Hexavalent chromium, Polybrominated biphenyls (PBBs), Polybrominated diphenyl ethers (PBDEs) comply with the limits as set by RoHS Directive 2011/65/EU recasting 2002/95/EC.
Note : The test results are related only to the tested items. The report shall not be reproduced except in full without the written approval of the testing laboratory.

Signed for and on behalf of
SGS-CSTC Ltd.

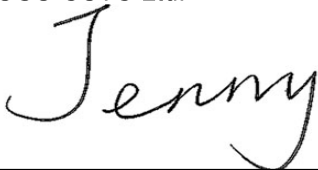

JENNY LIAO

Approved Signatory

This document is issued by the Company subject to its General Conditions of Service printed overleaf, available on request or accessible at http://www.sgs.com/terms_and_conditions.htm and, for electronic format documents, subject to Terms and Conditions for Electronic Documents at www.sgs.com/terms_e-document.htm. Attention is drawn to the limitation of liability, jurisdiction and jurisdiction issues defined therein. Any holder of this document is advised that information contained hereon reflects the Company's findings at the time of its preparation only, and within the limits of Client's instructions, if any. The Company's sole responsibility is to its Client and this document does not exonerate parties to a transaction from exercising all their rights and obligations under the transaction documents. This document cannot be reproduced except in full, without prior written approval of the Company. Any unauthorized alteration, forgery or falsification of the content or appearance of this document is unlawful and offenders may be prosecuted to the fullest extent of the law. All other data stated in the results shown in this test report refer only to the sample(s) tested.

Verification Report

No. CANEC1216278501

Date: 07-Jan-2015

Page 2 of 20

Verification Method :

1. Review was performed for the samples disjoined from the submitted articles and the related test reports submitted by the Applicant
2. Tests were performed for the samples indicated by the photos in the report with test methods reference to IEC 62321:2008: Procedures for the Determination of Levels of Six Regulated Substances in Electrotechnical Products
 - (1) Screening by XRF Spectroscopy
 - (2) Wet Chemical Test Method
 - a. Determination of Lead & Cadmium by ICP-OES or AAS
 - b. Determination of Mercury by ICP-OES
 - c. Determination of Hexavalent Chromium by Spot test or Colorimetric Method
 - d. Determination of PBBs and PBDEs by GC-MS

This document is issued by the Company subject to its General Conditions of Service printed overleaf, available on request or accessible at http://www.sgs.com/terms_and_conditions.htm and, for electronic format documents, subject to Terms and Conditions for Electronic Documents at www.sgs.com/terms_e-document.htm. Attention is drawn to the limitation of liability, indemnification and jurisdiction issues defined therein. Any holder of this document is advised that information contained hereon reflects the Company's findings at the time of its preparation only, and within the limits of Client's instructions, if any. The Company's sole responsibility is to its Client and this document does not exonerate parties to a transaction from exercising all their rights and obligations under the transaction documents. This document cannot be reproduced except in full, without prior written approval of the Company. Any unauthorized alteration, forgery or falsification of the content or appearance of this document is unlawful and offenders may be prosecuted to the fullest extent of the law. Unless otherwise stated, the results shown in this test report refer only to the sample(s) tested.

Verification Report

No. CANEC1216278501

Date: 07-Jan-2015

Page 3 of 20

Part No.	Part Description	BOM No.	Restricted Substances	Results of EDXRF (1)	Result of Wet Chemical Testing(2) (mg/kg)	Conclusion on EU RoHS	Sample Submitted Resubmitted Date
1	White plastic shell		Pb Cd Hg Cr(VI) PBBs PBDEs	BL BL BL BL BL BL	--- --- --- --- --- ---	Comply Comply Comply Comply Comply Comply	29 Nov 2014
2	White plastic part (connected w/ No.1)		Pb Cd Hg Cr(VI) PBBs PBDEs	BL BL BL BL BL BL	--- --- --- --- --- ---	Comply Comply Comply Comply Comply Comply	29 Nov 2014
3	White plastic nut (connected w/ No.2)		Pb Cd Hg Cr(VI) PBBs PBDEs	BL BL BL BL BL BL	--- --- --- --- --- ---	Comply Comply Comply Comply Comply Comply	29 Nov 2014
4	Silvery metal nut (in No.3)		Pb Cd Hg Cr(VI) PBBs PBDEs	OL BL BL BL --- ---	29264▲ --- --- --- --- ---	Comply Comply Comply Comply --- ---	29 Nov 2014

This document is issued by the Company subject to its General Conditions of Service printed overleaf, available on request or accessible at http://www.sgs.com/terms_and_conditions.htm and, for electronic format documents, subject to Terms and Conditions for Electronic Documents at www.sgs.com/terms_e-document.htm. Attention is drawn to the limitation of liability, indemnification and jurisdiction issues defined therein. Any holder of this document is advised that information contained hereon reflects the Company's findings at the time of its preparation only, and within the limits of Client's instructions, if any. The Company's sole responsibility is to its Client and this document does not exonerate parties to a transaction from exercising all their rights and obligations under the transaction documents. This document cannot be reproduced except in full, without prior written approval of the Company. Any unauthorized alteration, forgery or falsification of the content or appearance of this document is unlawful and offenders may be prosecuted to the fullest extent of the law. Unless otherwise stated, the results shown in this test report refer only to the sample(s) tested.

Verification Report

No. CANEC1216278501

Date: 07-Jan-2015

Page 4 of 20

Part No.	Part Description	BOM No.	Restricted Substances	Results of EDXRF (1)	Result of Wet Chemical Testing(2) (mg/kg)	Conclusion on EU RoHS	Sample Submitted/ Resubmitted Date
5	Silvery metal tube (connected w/ No.4)		Pb Cd Hg Cr(VI) PBBs PBDEs	OL BL BL BL --- ---	34278▲ --- --- --- --- ---	Comply Comply Comply Comply --- ---	29 Nov 2014
6 -C	Silvery metal ring (in No.4)		Pb Cd Hg Cr(VI) PBBs PBDEs	OL BL BL BL --- ---	28984▲ --- --- --- --- ---	Comply Comply Comply Comply --- ---	29 Nov 2014
7	White plastic ring (in No.4)		Pb Cd Hg Cr(VI) PBBs PBDEs	BL BL BL BL BL BL	--- --- --- --- --- ---	Comply Comply Comply Comply Comply Comply	29 Nov 2014
8	Red rubber ring (in No.4)		Pb Cd Hg Cr(VI) PBBs PBDEs	BL BL BL BL BL BL	--- --- --- --- --- ---	Comply Comply Comply Comply Comply Comply	29 Nov 2014

This document is issued by the Company subject to its General Conditions of Service printed overleaf, available on request or accessible at http://www.sgs.com/terms_and_conditions.htm and, for electronic format documents, subject to Terms and Conditions for Electronic Documents at www.sgs.com/terms_e-document.htm. Attention is drawn to the limitation of liability, indemnification and jurisdiction issues defined therein. Any holder of this document is advised that information contained hereon reflects the Company's findings at the time of its preparation only, and within the limits of Client's instructions, if any. The Company's sole responsibility is to its Client and this document does not exonerate parties to a transaction from exercising all their rights and obligations under the transaction documents. This document cannot be reproduced except in full, without prior written approval of the Company. Any unauthorized alteration, forgery or falsification of the content or appearance of this document is unlawful and offenders may be prosecuted to the fullest extent of the law. Unless otherwise stated, the results shown in this test report refer only to the sample(s) tested.

Verification Report

No. CANEC1216278501

Date: 07-Jan-2015

Page 5 of 20

Part No.	Part Description	BOM No.	Restricted Substances	Results of EDXRF (1)	Result of Wet Chemical Testing(2) (mg/kg)	Conclusion on EU RoHS	Sample Submitted Resubmitted Date
9	White plastic tube (in No.5)		Pb Cd Hg Cr(VI) PBBs PBDEs	BL BL BL BL BL BL	--- --- --- --- --- ---	Comply Comply Comply Comply Comply Comply	29 Nov 2014
10	Golden metal tube (in No.9)		Pb Cd Hg Cr(VI) PBBs PBDEs	OL BL BL BL --- ---	24932▲ --- --- --- --- ---	Comply Comply Comply Comply --- ---	29 Nov 2014
11	Silvery metal part (in No.2)		Pb Cd Hg Cr(VI) PBBs PBDEs	BL BL BL BL --- ---	--- --- --- --- --- ---	Comply Comply Comply Comply --- ---	29 Nov 2014
12	Silvery metal tube (in No.11)		Pb Cd Hg Cr(VI) PBBs PBDEs	OL BL BL BL --- ---	30455▲ --- --- --- --- ---	Comply Comply Comply Comply --- ---	29 Nov 2014

This document is issued by the Company subject to its General Conditions of Service printed overleaf, available on request or accessible at http://www.sgs.com/terms_and_conditions.htm and, for electronic format documents, subject to Terms and Conditions for Electronic Documents at www.sgs.com/terms_e-document.htm. Attention is drawn to the limitation of liability, indemnification and jurisdiction issues defined therein. Any holder of this document is advised that information contained hereon reflects the Company's findings at the time of its preparation only, and within the limits of Client's instructions, if any. The Company's sole responsibility is to its Client and this document does not exonerate parties to a transaction from exercising all their rights and obligations under the transaction documents. This document cannot be reproduced except in full, without prior written approval of the Company. Any unauthorized alteration, forgery or falsification of the content or appearance of this document is unlawful and offenders may be prosecuted to the fullest extent of the law. Unless otherwise stated, the results shown in this test report refer only to the sample(s) tested.

Verification Report

No. CANEC1216278501

Date: 07-Jan-2015

Page 6 of 20

Part No.	Part Description	BOM No.	Restricted Substances	Results of EDXRF (1)	Result of Wet Chemical Testing(2) (mg/kg)	Conclusion on EU RoHS	Sample Submitted Resubmitted Date
13	Golden metal rod (in No.1)		Pb Cd Hg Cr(VI) PBBs PBDEs	BL BL BL BL --- ---	--- --- --- --- --- ---	Comply Comply Comply Comply --- ---	29 Nov 2014
14	Black foam ring (on No.13)		Pb Cd Hg Cr(VI) PBBs PBDEs	BL BL BL BL BL BL	--- --- --- --- --- ---	Comply Comply Comply Comply Comply Comply	29 Nov 2014
15	Silvery metal rod (connected w/ No.13)		Pb Cd Hg Cr(VI) PBBs PBDEs	BL BL BL BL --- ---	--- --- --- --- --- ---	Comply Comply Comply Comply --- ---	29 Nov 2014
16	Black plastic (heat shrinkable tube) (on No.15)		Pb Cd Hg Cr(VI) PBBs PBDEs	BL BL BL BL BL BL	--- --- --- --- --- ---	Comply Comply Comply Comply Comply Comply	29 Nov 2014

This document is issued by the Company subject to its General Conditions of Service printed overleaf, available on request or accessible at http://www.sgs.com/terms_and_conditions.htm and, for electronic format documents, subject to Terms and Conditions for Electronic Documents at www.sgs.com/terms_e-document.htm. Attention is drawn to the limitation of liability, indemnification and jurisdiction issues defined therein. Any holder of this document is advised that information contained hereon reflects the Company's findings at the time of its preparation only, and within the limits of Client's instructions, if any. The Company's sole responsibility is to its Client and this document does not exonerate parties to a transaction from exercising all their rights and obligations under the transaction documents. This document cannot be reproduced except in full, without prior written approval of the Company. Any unauthorized alteration, forgery or falsification of the content or appearance of this document is unlawful and offenders may be prosecuted to the fullest extent of the law. Unless otherwise stated, the results shown in this test report refer only to the sample(s) tested.

Verification Report

No. CANEC1216278501

Date: 07-Jan-2015

Page 7 of 20

Part No.	Part Description	BOM No.	Restricted Substances	Results of EDXRF (1)	Result of Wet Chemical Testing(2) (mg/kg)	Conclusion on EU RoHS	Sample Submitted Resubmitted Date
17	Golden metal tube (connected w/ No.16)		Pb Cd Hg Cr(VI) PBBs PBDEs	OL BL BL BL --- ---	30411▲ --- --- --- --- ---	Comply Comply Comply Comply --- ---	29 Nov 2014
18	White glue (connected w/ No.16)		Pb Cd Hg Cr(VI) PBBs PBDEs	BL BL BL BL BL BL	--- --- --- --- --- ---	Comply Comply Comply Comply Comply Comply	29 Nov 2014
19	White plastic cover (connected w/ No.17)		Pb Cd Hg Cr(VI) PBBs PBDEs	BL BL BL BL BL BL	--- --- --- --- --- ---	Comply Comply Comply Comply Comply Comply	29 Nov 2014
20	Pink transparent plastic (cable jacket) (connected w/ No.19)		Pb Cd Hg Cr(VI) PBBs PBDEs	BL BL BL BL BL BL	--- --- --- --- --- ---	Comply Comply Comply Comply Comply Comply	29 Nov 2014

This document is issued by the Company subject to its General Conditions of Service printed overleaf, available on request or accessible at http://www.sgs.com/terms_and_conditions.htm and, for electronic format documents, subject to Terms and Conditions for Electronic Documents at www.sgs.com/terms_e-document.htm. Attention is drawn to the limitation of liability, indemnification and jurisdiction issues defined therein. Any holder of this document is advised that information contained hereon reflects the Company's findings at the time of its preparation only, and within the limits of Client's instructions, if any. The Company's sole responsibility is to its Client and this document does not exonerate parties to a transaction from exercising all their rights and obligations under the transaction documents. This document cannot be reproduced except in full, without prior written approval of the Company. Any unauthorized alteration, forgery or falsification of the content or appearance of this document is unlawful and offenders may be prosecuted to the fullest extent of the law. Unless otherwise stated, the results shown in this test report refer only to the sample(s) tested.

Verification Report

No. CANEC1216278501

Date: 07-Jan-2015

Page 8 of 20

Part No.	Part Description	BOM No.	Restricted Substances	Results of EDXRF (1)	Result of Wet Chemical Testing(2) (mg/kg)	Conclusion on EU RoHS	Sample Submitted Resubmitted Date
21	Silvery metal wire (in No.20)		Pb Cd Hg Cr(VI) PBBs PBDEs	BL BL BL BL --- ---	--- --- --- --- --- ---	Comply Comply Comply Comply --- ---	29 Nov 2014
22	White plastic (wire insulation) (in No.21)		Pb Cd Hg Cr(VI) PBBs PBDEs	BL BL BL BL BL BL	--- --- --- --- --- ---	Comply Comply Comply Comply Comply Comply	29 Nov 2014
23	Black plastic shell		Pb Cd Hg Cr(VI) PBBs PBDEs	BL BL BL BL BL BL	--- --- --- --- --- ---	Comply Comply Comply Comply Comply Comply	29 Nov 2014
24	Black plastic part (connected w/ No.23)		Pb Cd Hg Cr(VI) PBBs PBDEs	BL BL BL BL BL BL	--- --- --- --- --- ---	Comply Comply Comply Comply Comply Comply	29 Nov 2014

This document is issued by the Company subject to its General Conditions of Service printed overleaf, available on request or accessible at http://www.sgs.com/terms_and_conditions.htm and, for electronic format documents, subject to Terms and Conditions for Electronic Documents at www.sgs.com/terms_e-document.htm. Attention is drawn to the limitation of liability, indemnification and jurisdiction issues defined therein. Any holder of this document is advised that information contained hereon reflects the Company's findings at the time of its preparation only, and within the limits of Client's instructions, if any. The Company's sole responsibility is to its Client and this document does not exonerate parties to a transaction from exercising all their rights and obligations under the transaction documents. This document cannot be reproduced except in full, without prior written approval of the Company. Any unauthorized alteration, forgery or falsification of the content or appearance of this document is unlawful and offenders may be prosecuted to the fullest extent of the law. Unless otherwise stated, the results shown in this test report refer only to the sample(s) tested.

Verification Report

No. CANEC1216278501

Date: 07-Jan-2015

Page 9 of 20

Part No.	Part Description	BOM No.	Restricted Substances	Results of EDXRF (1)	Result of Wet Chemical Testing(2) (mg/kg)	Conclusion on EU RoHS	Sample Submitted Resubmitted Date
25	Grey plastic (cable jacket) (connected w/ No.24)		Pb Cd Hg Cr(VI) PBBs PBDEs	BL BL BL BL BL BL	--- --- --- --- --- ---	Comply Comply Comply Comply Comply Comply	29 Nov 2014
26	Transparent plastic (wire insulation) (in No.25)		Pb Cd Hg Cr(VI) PBBs PBDEs	BL BL BL BL BL BL	--- --- --- --- --- ---	Comply Comply Comply Comply Comply Comply	29 Nov 2014
27	Golden metal rod (in No.23)		Pb Cd Hg Cr(VI) PBBs PBDEs	BL BL BL BL --- ---	--- --- --- --- --- ---	Comply Comply Comply Comply --- ---	29 Nov 2014
28	Silvery metal rod (connected w/ No.27)		Pb Cd Hg Cr(VI) PBBs PBDEs	BL BL BL BL --- ---	--- --- --- --- --- ---	Comply Comply Comply Comply --- ---	29 Nov 2014

This document is issued by the Company subject to its General Conditions of Service printed overleaf, available on request or accessible at http://www.sgs.com/terms_and_conditions.htm and, for electronic format documents, subject to Terms and Conditions for Electronic Documents at www.sgs.com/terms_e-document.htm. Attention is drawn to the limitation of liability, indemnification and jurisdiction issues defined therein. Any holder of this document is advised that information contained hereon reflects the Company's findings at the time of its preparation only, and within the limits of Client's instructions, if any. The Company's sole responsibility is to its Client and this document does not exonerate parties to a transaction from exercising all their rights and obligations under the transaction documents. This document cannot be reproduced except in full, without prior written approval of the Company. Any unauthorized alteration, forgery or falsification of the content or appearance of this document is unlawful and offenders may be prosecuted to the fullest extent of the law. Unless otherwise stated, the results shown in this test report refer only to the sample(s) tested.

Verification Report

No. CANEC1216278501

Date: 07-Jan-2015

Page 10 of 20

Part No.	Part Description	BOM No.	Restricted Substances	Results of EDXRF (1)	Result of Wet Chemical Testing(2) (mg/kg)	Conclusion on EU RoHS	Sample Submitted/ Resubmitted Date
29	Golden metal tube (connected w/ No.28)		Pb	OL	31558▲	Comply	29 Nov 2014
			Cd	BL	---	Comply	
			Hg	BL	---	Comply	
			Cr(VI)	BL	---	Comply	
			PBBs	---	---	---	
			PBDEs	---	---	---	

This document is issued by the Company subject to its General Conditions of Service printed overleaf, available on request or accessible at http://www.sgs.com/terms_and_conditions.htm and, for electronic format documents, subject to Terms and Conditions for Electronic Documents at www.sgs.com/terms_e-document.htm. Attention is drawn to the limitation of liability, indemnification and jurisdiction issues defined therein. Any holder of this document is advised that information contained hereon reflects the Company's findings at the time of its preparation only, and within the limits of Client's instructions, if any. The Company's sole responsibility is to its Client and this document does not exonerate parties to a transaction from exercising all their rights and obligations under the transaction documents. This document cannot be reproduced except in full, without prior written approval of the Company. Any unauthorized alteration, forgery or falsification of the content or appearance of this document is unlawful and offenders may be prosecuted to the fullest extent of the law. Unless otherwise stated, the results shown in this test report refer only to the sample(s) tested.

Verification Report

No. CANEC1216278501

Date: 07-Jan-2015

Page 11 of 20

Remark :

- (1) (a) There are the results on total Br while test items on restricted substances are PBBs and PBDEs. There is the result on total Cr while test item on restricted substances is Cr(VI).
- (b) Results are obtained by EDXRF for primary screening, and further chemical testing by ICP-OES (for Cd, Pb, Hg), UV-Vis (for Cr(VI)) and GC-MS (for PBBs, PBDEs) is recommended to be performed, if the concentration exceeds the below warning value according to IEC62321 (unit: mg/kg)

Element	Polymer	Metal	Composite Materials
Cd	$BL \leq (70-3\sigma) < X < (130+3\sigma) \leq OL$	$BL \leq (70-3\sigma) < X < (130+3\sigma) \leq OL$	$LOD < X < (150+3\sigma) \leq OL$
Pb	$BL \leq (700-3\sigma) < X < (1300+3\sigma) \leq OL$	$BL \leq (700-3\sigma) < X < (1300+3\sigma) \leq OL$	$BL \leq (500-3\sigma) < X < (1500+3\sigma) \leq OL$
Hg	$BL \leq (700-3\sigma) < X < (1300+3\sigma) \leq OL$	$BL \leq (700-3\sigma) < X < (1300+3\sigma) \leq OL$	$BL \leq (500-3\sigma) < X < (1500+3\sigma) \leq OL$
Br	$BL \leq (300-3\sigma) < X$	--	$BL \leq (250-3\sigma) < X$
Cr	$BL \leq (700-3\sigma) < X$	$BL \leq (700-3\sigma) < X$	$BL \leq (500-3\sigma) < X$

(c) BL = Below Limit, OL = Over Limit, IN = Inconclusive, LOD = Limit of Detection, -- = Not regulated.

(d) The XRF screening test for RoHS elements - The reading may be different to the actual content in the sample be of non-uniformity composition.

- (2) (a) mg/kg = 0.0001%, MDL = Method detection Limit, ND = Not Detected (<MDL), --- = Not conducted, - = Without BOM.

(b) Unit and MDL in wet chemical test

Test Item	Pb	Cd	Hg
Unit	mg/kg	mg/kg	mg/kg
MDL	2	2	2

The MDL for single compound of PBBs and PBDEs is 5 mg/kg, MDL of Cr(VI) for polymer and composite sample is 2 mg/kg.

- (c) According to IEC 62321:2008, result on Cr(VI) for metal sample is shown as Positive/Negative. Negative = Absence of Cr(VI) coating, Positive = Presence of Cr(VI) coating.

This document is issued by the Company subject to its General Conditions of Service printed overleaf, available on request or accessible at http://www.sgs.com/terms_and_conditions.htm and, for electronic format documents, subject to Terms and Conditions for Electronic Documents at www.sgs.com/terms_e-document.htm. Attention is drawn to the limitation of liability, indemnification and jurisdiction issues defined therein. Any holder of this document is advised that information contained hereon reflects the Company's findings at the time of its preparation only, and within the limits of Client's instructions, if any. The Company's sole responsibility is to its Client and this document does not exonerate parties to a transaction from exercising all their rights and obligations under the transaction documents. This document cannot be reproduced except in full, without prior written approval of the Company. Any unauthorized alteration, forgery or falsification of the content or appearance of this document is unlawful and offenders may be prosecuted to the fullest extent of the law. Unless otherwise stated, the results shown in this test report refer only to the sample(s) tested.

(d)▲= According to the declaration from the client,

Lead (Pb) in No.4, No.5, No.6-C, No.10, No.12, No.17 & No.29 are exempted by EU RoHS Directive 2011/65/EU based on: Copper alloy containing up to 4 % lead by weight.

This document is issued by the Company subject to its General Conditions of Service printed overleaf, available on request or accessible at http://www.sgs.com/terms_and_conditions.htm and, for electronic format documents, subject to Terms and Conditions for Electronic Documents at www.sgs.com/terms_e-document.htm. Attention is drawn to the limitation of liability, indemnification and jurisdiction issues defined therein. Any holder of this document is advised that information contained hereon reflects the Company's findings at the time of its preparation only, and within the limits of Client's instructions, if any. The Company's sole responsibility is to its Client and this document does not exonerate parties to a transaction from exercising all their rights and obligations under the transaction documents. This document cannot be reproduced except in full, without prior written approval of the Company. Any unauthorized alteration, forgery or falsification of the content or appearance of this document is unlawful and offenders may be prosecuted to the fullest extent of the law. Unless otherwise stated, the results shown in this test report refer only to the sample(s) tested.

Sample photo:

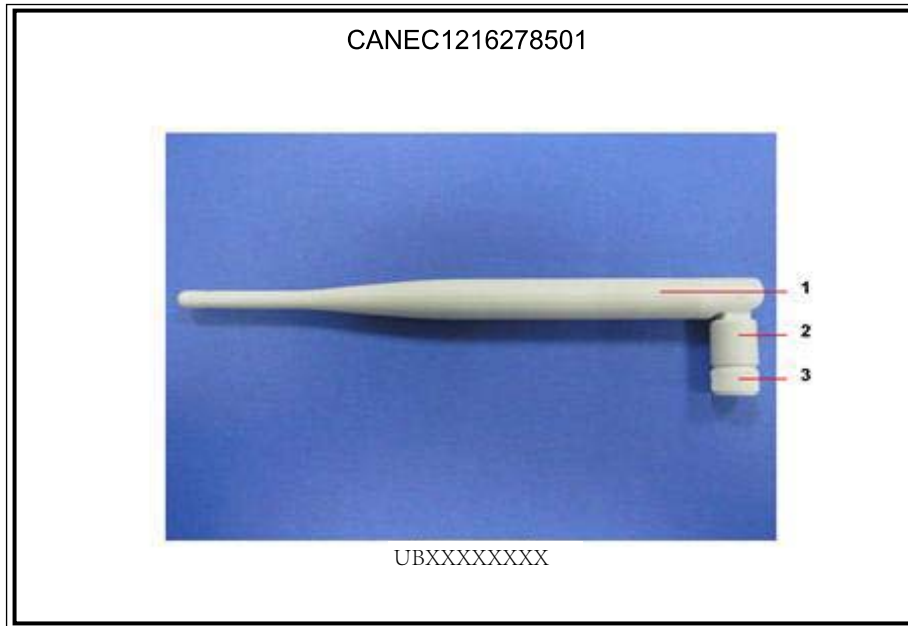

This document is issued by the Company subject to its General Conditions of Service printed overleaf, available on request or accessible at http://www.sgs.com/terms_and_conditions.htm and, for electronic format documents, subject to Terms and Conditions for Electronic Documents at www.sgs.com/terms_e-document.htm. Attention is drawn to the limitation of liability, indemnification and jurisdiction issues defined therein. Any holder of this document is advised that information contained hereon reflects the Company's findings at the time of its preparation only, and within the limits of Client's instructions, if any. The Company's sole responsibility is to its Client and this document does not exonerate parties to a transaction from exercising all their rights and obligations under the transaction documents. This document cannot be reproduced except in full, without prior written approval of the Company. Any unauthorized alteration, forgery or falsification of the content or appearance of this document is unlawful and offenders may be prosecuted to the fullest extent of the law. Unless otherwise stated, the results shown in this test report refer only to the sample(s) tested.



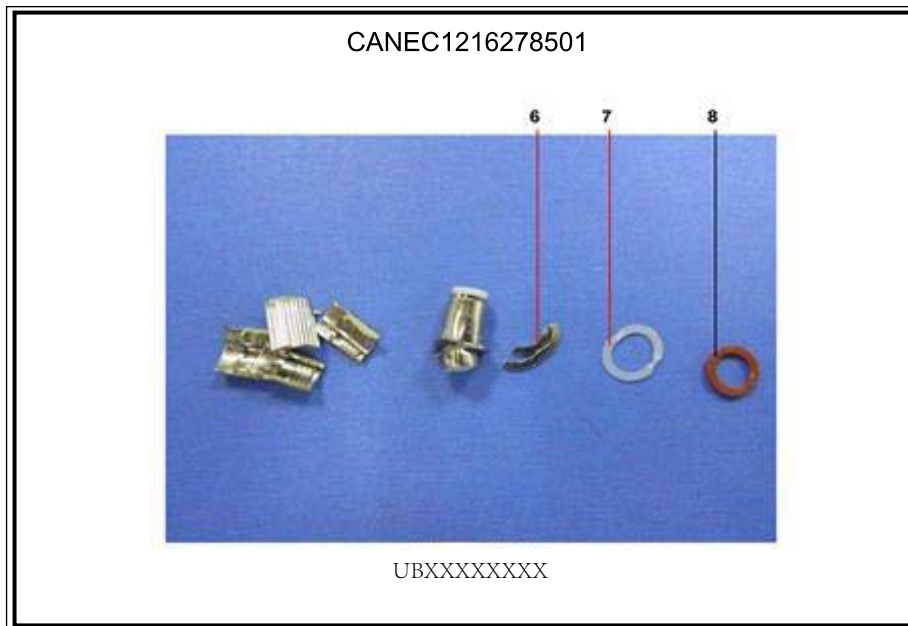

This document is issued by the Company subject to its General Conditions of Service printed overleaf, available on request or accessible at http://www.sgs.com/terms_and_conditions.htm and, for electronic format documents, subject to Terms and Conditions for Electronic Documents at www.sgs.com/terms_e-document.htm. Attention is drawn to the limitation of liability, indemnification and jurisdiction issues defined therein. Any holder of this document is advised that information contained hereon reflects the Company's findings at the time of its preparation only, and within the limits of Client's instructions, if any. The Company's sole responsibility is to its Client and this document does not exonerate parties to a transaction from exercising all their rights and obligations under the transaction documents. This document cannot be reproduced except in full, without prior written approval of the Company. Any unauthorized alteration, forgery or falsification of the content or appearance of this document is unlawful and offenders may be prosecuted to the fullest extent of the law. Unless otherwise stated, the results shown in this test report refer only to the sample(s) tested.

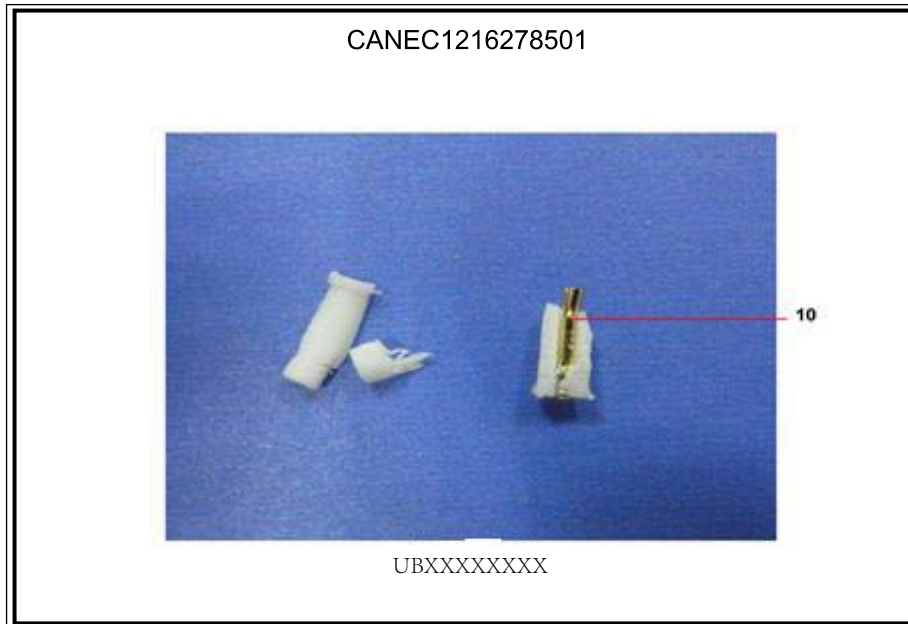
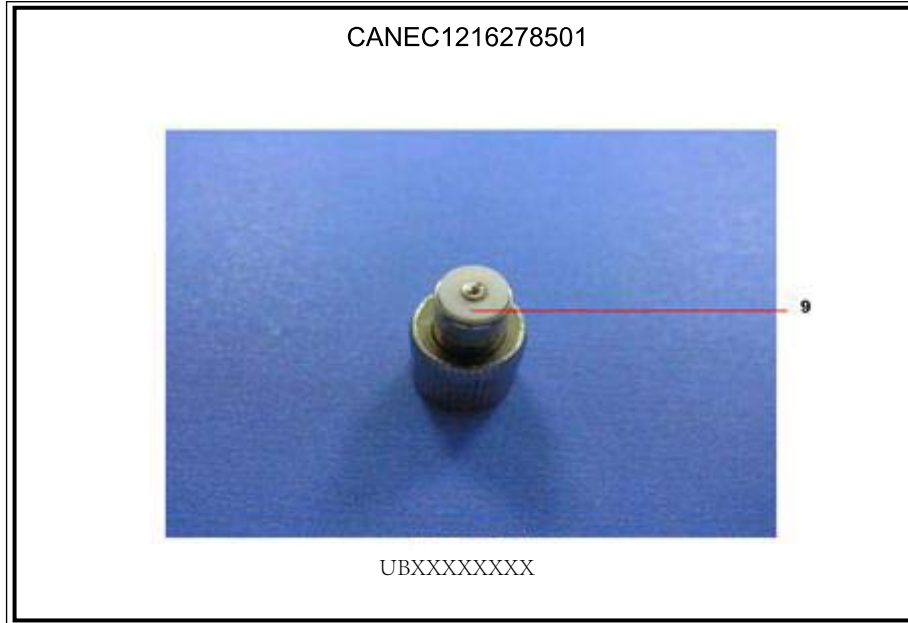

This document is issued by the Company subject to its General Conditions of Service printed overleaf, available on request or accessible at http://www.sgs.com/terms_and_conditions.htm and, for electronic format documents, subject to Terms and Conditions for Electronic Documents at www.sgs.com/terms_e-document.htm. Attention is drawn to the limitation of liability, indemnification and jurisdiction issues defined therein. Any holder of this document is advised that information contained hereon reflects the Company's findings at the time of its preparation only, and within the limits of Client's instructions, if any. The Company's sole responsibility is to its Client and this document does not exonerate parties to a transaction from exercising all their rights and obligations under the transaction documents. This document cannot be reproduced except in full, without prior written approval of the Company. Any unauthorized alteration, forgery or falsification of the content or appearance of this document is unlawful and offenders may be prosecuted to the fullest extent of the law. Unless otherwise stated, the results shown in this test report refer only to the sample(s) tested.

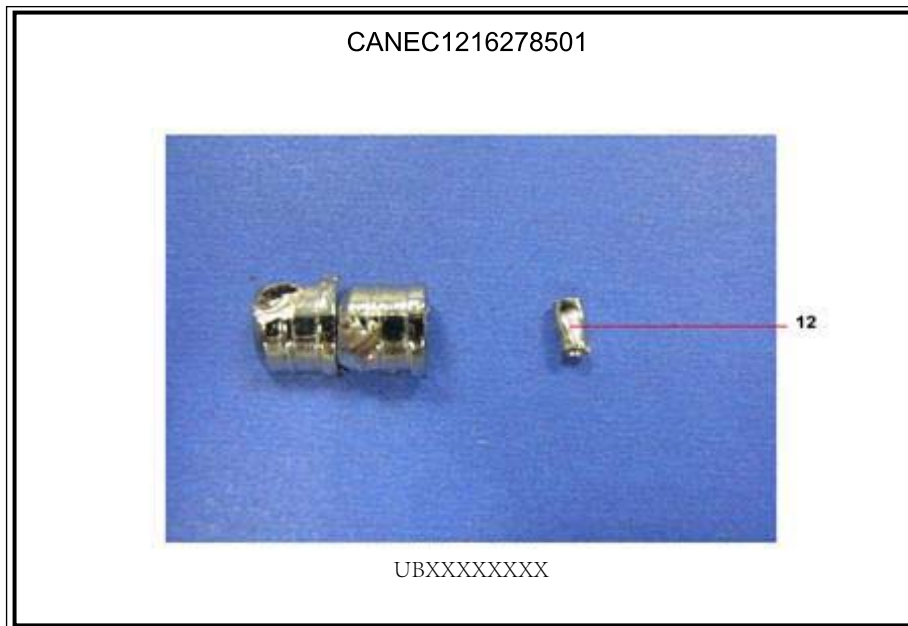

This document is issued by the Company subject to its General Conditions of Service printed overleaf, available on request or accessible at http://www.sgs.com/terms_and_conditions.htm and, for electronic format documents, subject to Terms and Conditions for Electronic Documents at www.sgs.com/terms_e-document.htm. Attention is drawn to the limitation of liability, indemnification and jurisdiction issues defined therein. Any holder of this document is advised that information contained hereon reflects the Company's findings at the time of its preparation only, and within the limits of Client's instructions, if any. The Company's sole responsibility is to its Client and this document does not exonerate parties to a transaction from exercising all their rights and obligations under the transaction documents. This document cannot be reproduced except in full, without prior written approval of the Company. Any unauthorized alteration, forgery or falsification of the content or appearance of this document is unlawful and offenders may be prosecuted to the fullest extent of the law. Unless otherwise stated, the results shown in this test report refer only to the sample(s) tested.

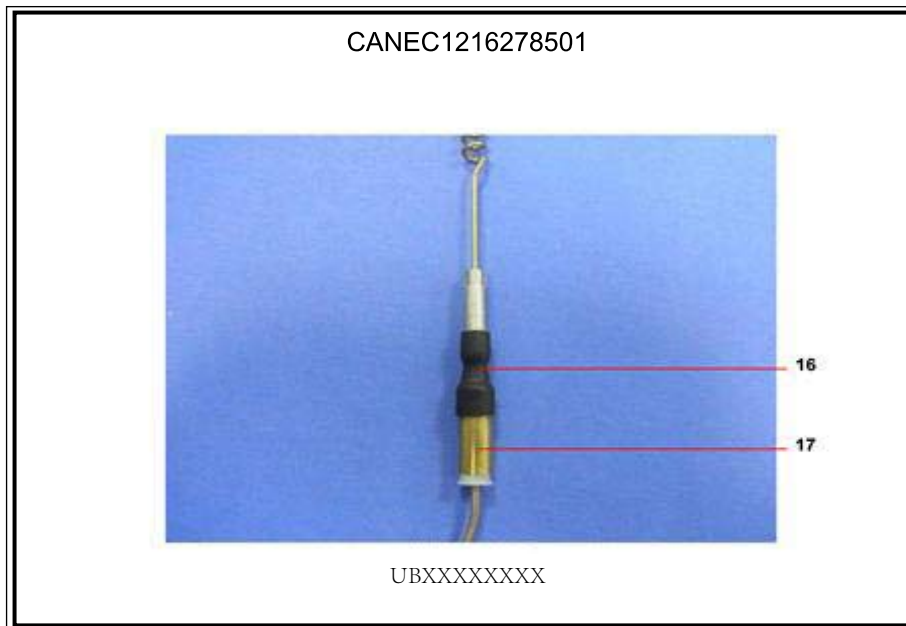
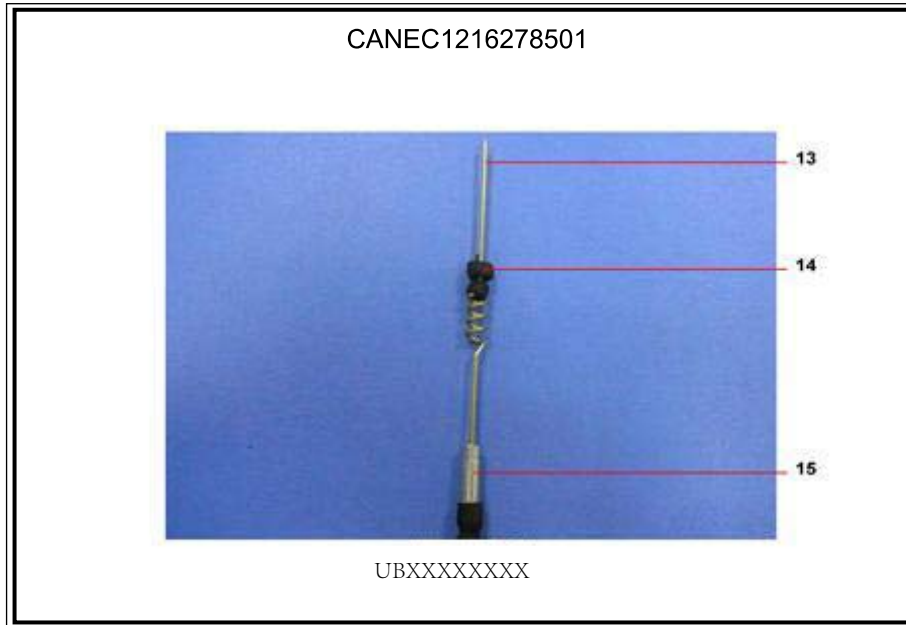

This document is issued by the Company subject to its General Conditions of Service printed overleaf, available on request or accessible at http://www.sgs.com/terms_and_conditions.htm and, for electronic format documents, subject to Terms and Conditions for Electronic Documents at www.sgs.com/terms_e-document.htm. Attention is drawn to the limitation of liability, indemnification and jurisdiction issues defined therein. Any holder of this document is advised that information contained hereon reflects the Company's findings at the time of its preparation only, and within the limits of Client's instructions, if any. The Company's sole responsibility is to its Client and this document does not exonerate parties to a transaction from exercising all their rights and obligations under the transaction documents. This document cannot be reproduced except in full, without prior written approval of the Company. Any unauthorized alteration, forgery or falsification of the content or appearance of this document is unlawful and offenders may be prosecuted to the fullest extent of the law. Unless otherwise stated, the results shown in this test report refer only to the sample(s) tested.

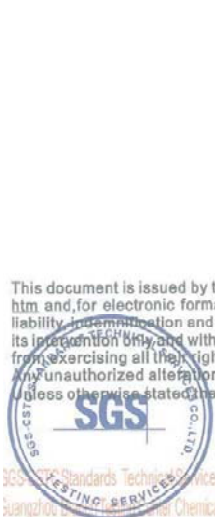

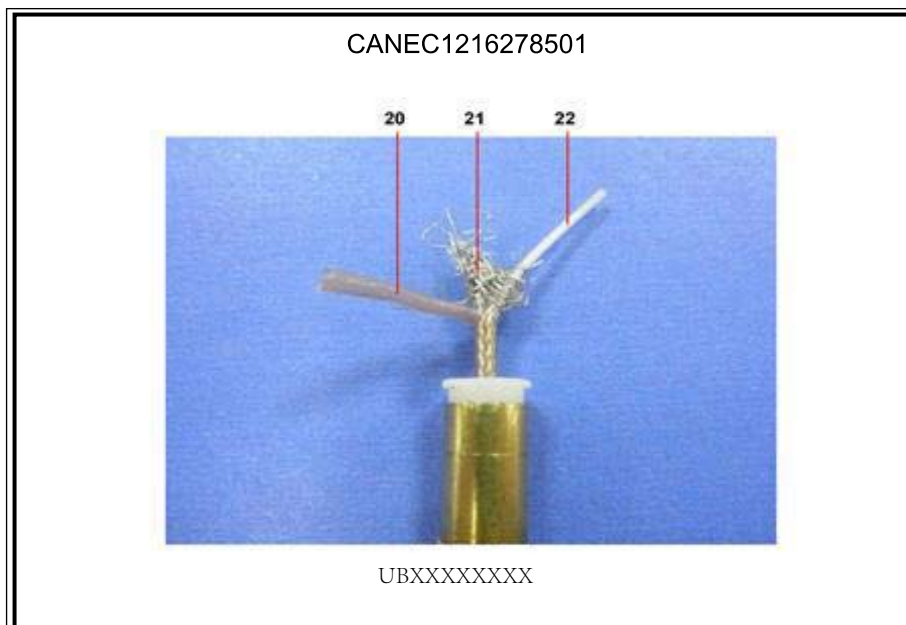

This document is issued by the Company subject to its General Conditions of Service printed overleaf, available on request or accessible at http://www.sgs.com/terms_and_conditions.htm and, for electronic format documents, subject to Terms and Conditions for Electronic Documents at www.sgs.com/terms_e-document.htm. Attention is drawn to the limitation of liability, indemnification and jurisdiction issues defined therein. Any holder of this document is advised that information contained hereon reflects the Company's findings at the time of its preparation only, and within the limits of Client's instructions, if any. The Company's sole responsibility is to its Client and this document does not exonerate parties to a transaction from exercising all their rights and obligations under the transaction documents. This document cannot be reproduced except in full, without prior written approval of the Company. Any unauthorized alteration, forgery or falsification of the content or appearance of this document is unlawful and offenders may be prosecuted to the fullest extent of the law. Unless otherwise stated, the results shown in this test report refer only to the sample(s) tested.

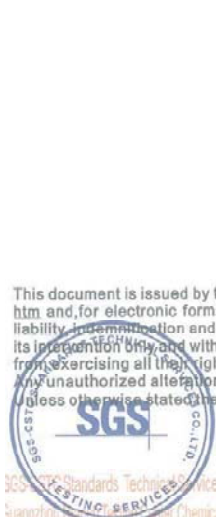

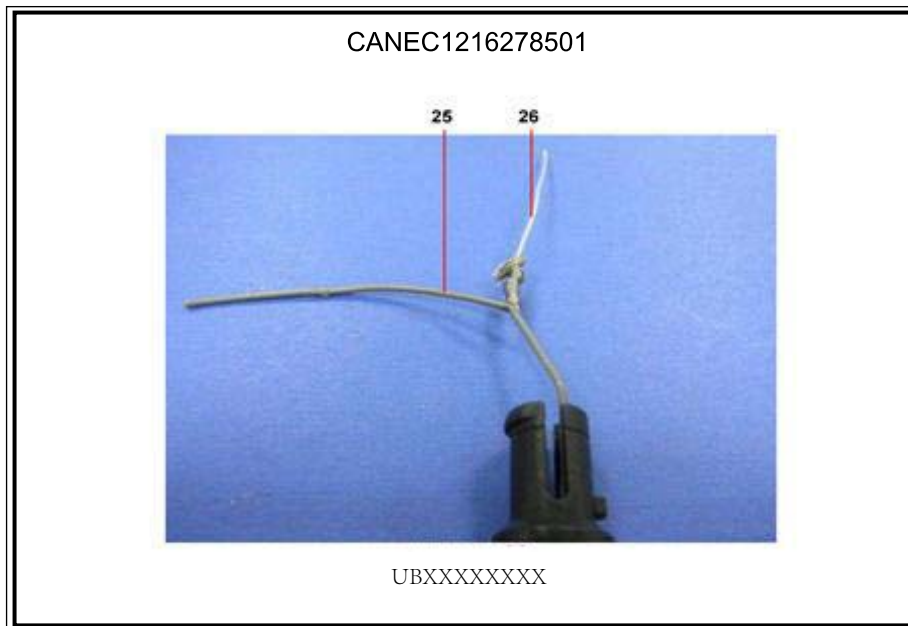

This document is issued by the Company subject to its General Conditions of Service printed overleaf, available on request or accessible at http://www.sgs.com/terms_and_conditions.htm and, for electronic format documents, subject to Terms and Conditions for Electronic Documents at www.sgs.com/terms_e-document.htm. Attention is drawn to the limitation of liability, indemnification and jurisdiction issues defined therein. Any holder of this document is advised that information contained hereon reflects the Company's findings at the time of its preparation only, and within the limits of Client's instructions, if any. The Company's sole responsibility is to its Client and this document does not exonerate parties to a transaction from exercising all their rights and obligations under the transaction documents. This document cannot be reproduced except in full, without prior written approval of the Company. Any unauthorized alteration, forgery or falsification of the content or appearance of this document is unlawful and offenders may be prosecuted to the fullest extent of the law. Unless otherwise stated, the results shown in this test report refer only to the sample(s) tested.

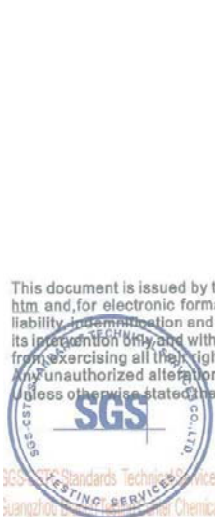

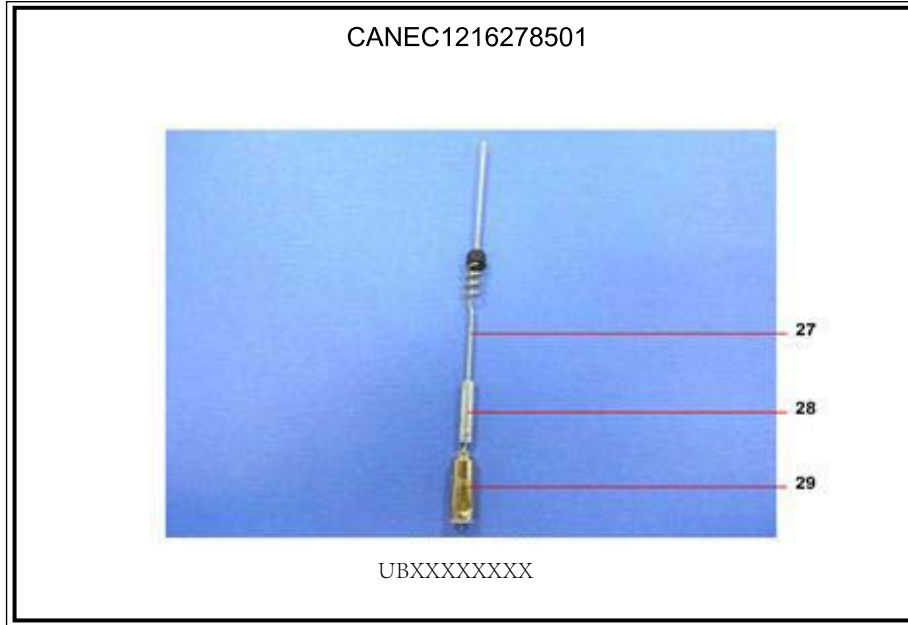

SGS authenticate the photo on original report only

*** End of Report ***

This document is issued by the Company subject to its General Conditions of Service printed overleaf, available on request or accessible at http://www.sgs.com/terms_and_conditions.htm and, for electronic format documents, subject to Terms and Conditions for Electronic Documents at www.sgs.com/terms_e-document.htm. Attention is drawn to the limitation of liability, indemnification and jurisdiction issues defined therein. Any holder of this document is advised that information contained hereon reflects the Company's findings at the time of its preparation only, and within the limits of Client's instructions, if any. The Company's sole responsibility is to its Client and this document does not exonerate parties to a transaction from exercising all their rights and obligations under the transaction documents. This document cannot be reproduced except in full, without prior written approval of the Company. Any unauthorized alteration, forgery or falsification of the content or appearance of this document is unlawful and offenders may be prosecuted to the fullest extent of the law. Unless otherwise stated, the results shown in this test report refer only to the sample(s) tested.