

FCC Test Report

Applicant : D2G Group LLC

Address : 81 Commerce Drive, Fall River,
Massachusetts, United States

Product Name : 49inch Indoor Floor Standing Digital Sign
With Camera & MIC, IR Touch

Report Date : Jul. 15, 2024

Shenzhen Anbotek Compliance Laboratory Limited



Contents

1. General Information	6
1.1. Client Information	6
1.2. Description of Device (EUT)	6
1.3. Auxiliary Equipment Used During Test	7
1.4. Description of Test Configuration	7
1.5. Description of Test Setup	8
1.6. Test Equipment List	9
1.7. Measurement Uncertainty	10
1.8. Description of Test Facility	10
1.9. Disclaimer	11
2. Summary of Test Results	12
3. Conducted Emission Test	13
3.1. Test Standard and Limit	13
3.2. Test Setup	13
3.3. Test Procedure	13
3.4. Test Data	13
4. Radiated Spurious Emission and Band Edge Test	16
4.1. Test Standard and Limit	16
4.2. Test Setup	16
4.3. Test Procedure	17
4.4. Test Data	18
5. Maximum Conducted Output Power Test	25
5.1. Test Standard and Limit	25
5.2. Test Setup	25
5.3. Test Procedure	25
5.4. Test Data	25
6. 6dB Bandwidth and 99% Occupied Bandwidth Test	26
6.1. Test Standard and Limit	26
6.2. Test Setup	26
6.3. Test Procedure	26
6.4. Test Data	26
7. Power Spectral Density Test	27
7.1. Test Standard and Limit	27
7.2. Test Setup	27
7.3. Test Procedure	27
7.4. Test Data	27
8. Conducted Spurious Emission and Band Edge Test	28
8.1. Test Standard and Limit	28



8.2. Test Setup	28
8.3. Test Procedure	28
8.4. Test Data	28
9. Antenna Requirement	29
9.1. Test Standard and Requirement	29
9.2. Antenna Connected Construction	29
APPENDIX I -- TEST SETUP PHOTOGRAPH	30
APPENDIX II -- EXTERNAL PHOTOGRAPH	30
APPENDIX III -- INTERNAL PHOTOGRAPH	30



TEST REPORT

Applicant : D2G Group LLC
Manufacturer : Shenzhen I-Pivot Intelligent Technology Co., Ltd
Product Name : 49inch Indoor Floor Standing Digital Sign With Camera & MIC, IR Touch
Model No. : DF049TLWM
Trade Mark : Displays2go
Rating(s) : Input: AC 100-240V, 0.7-1.5A, 50/60Hz, 140W
Test Standard(s) : **47 CFR Part 15.247**
Test Method(s) : **ANSI C63.10: 2020, KDB 558074 D01 15.247 Meas Guidance v05r02**

The device described above is tested by Shenzhen Anbotek Compliance Laboratory Limited to determine the maximum emission levels emanating from the device and the severe levels of the device can endure and its performance criterion. The measurement results are contained in this test report and Shenzhen Anbotek Compliance Laboratory Limited is assumed full of responsibility for the accuracy and completeness of these measurements. Also, this report shows that the EUT (Equipment Under Test) is technically compliant with the 47 CFR Part 15.247 requirements.

This report applies to above tested sample only and shall not be reproduced in part without written approval of Shenzhen Anbotek Compliance Laboratory Limited.

Date of Receipt

May 28, 2024

Date of Test

May 28 ~ Jun. 17, 2024

Prepared By



(Ella Liang)

Approved & Authorized Signer



(Edward Pan)



Revision History

Report Version	Description	Issued Date
R00	Original Issue.	Jul. 15, 2024



1. General Information

1.1. Client Information

Applicant	:	D2G Group LLC
Address	:	81 Commerce Drive, Fall River, Massachusetts, United States
Manufacturer	:	Shenzhen I-Pivot Intelligent Technology Co., Ltd
Address	:	2nd Floor, Building 2A, Dacheng Industrial Zone, No. 357 Jihua Rd, Longgang District, Shenzhen, Guangdong, China
Factory	:	Shenzhen I-Pivot Intelligent Technology Co., Ltd
Address	:	2nd Floor, Building 2A, Dacheng Industrial Zone, No. 357 Jihua Rd, Longgang District, Shenzhen, Guangdong, China

1.2. Description of Device (EUT)

Product Name	:	49inch Indoor Floor Standing Digital Sign With Camera & MIC, IR Touch
Model No.	:	DF049TLWM
Trade Mark	:	Displays2go
Test Power Supply	:	AC 120V, 60Hz
Test Sample No.	:	1-2-1(Normal Sample), 1-2-2(Engineering Sample)
Adapter	:	N/A
RF Specification		
Operation Mode	:	<input checked="" type="checkbox"/> BT BLE
Support Rate	:	<input checked="" type="checkbox"/> 1Mbps <input checked="" type="checkbox"/> 2Mbps
Operation Frequency	:	2402~2480MHz
Number of Channel	:	40 Channels
Modulation Type	:	GFSK
Antenna Type	:	Rod Antenna
Antenna Gain(Peak)	:	5dBi
Remark:		
1) All of the RF specification are provided by customer.		
2) For a more detailed features description, please refer to the manufacturer's specifications or the User's Manual.		



1.3. Auxiliary Equipment Used During Test

Description	Rating(s)
Adapter	Model: MDY-11-EX Input: 100-240V-0.7A, 50-60Hz USB-A output: 5V $\overline{=}$ 3A, 9V $\overline{=}$ 3A, 12V $\overline{=}$ 2.25A, 20V $\overline{=}$ 1.35A, 11V $\overline{=}$ 3A

1.4. Description of Test Configuration

Channel	Freq. (MHz)	Channel	Freq. (MHz)	Channel	Freq. (MHz)	Channel	Freq. (MHz)	Channel	Freq. (MHz)
00	2402	09	2420	18	2438	27	2456	36	2474
01	2404	10	2422	19	2440	28	2458	37	2476
02	2406	11	2424	20	2442	29	2460	38	2478
03	2408	12	2426	21	2444	30	2462	39	2480
04	2410	13	2428	22	2446	31	2464		
05	2412	14	2430	23	2448	32	2466		
06	2414	15	2432	24	2450	33	2468		
07	2416	16	2434	25	2452	34	2470		
08	2418	17	2436	26	2454	35	2472		

Note:

1. The engineering test program was provided and the EUT was programmed to be in continuously transmitting mode.
2. EUT was tested with channel 0, 19 and 39.



1.5. Description of Test Setup

CE

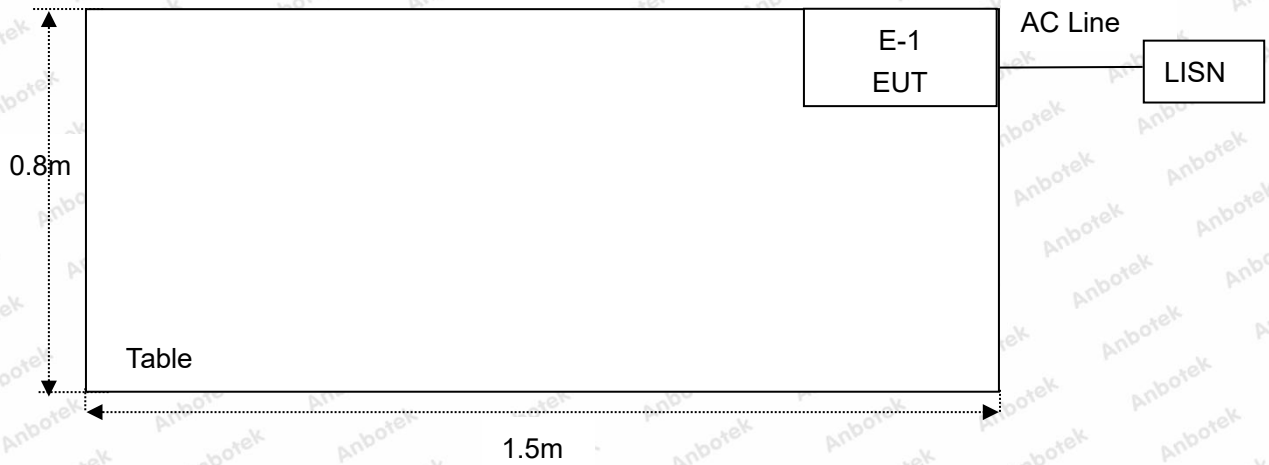

RE

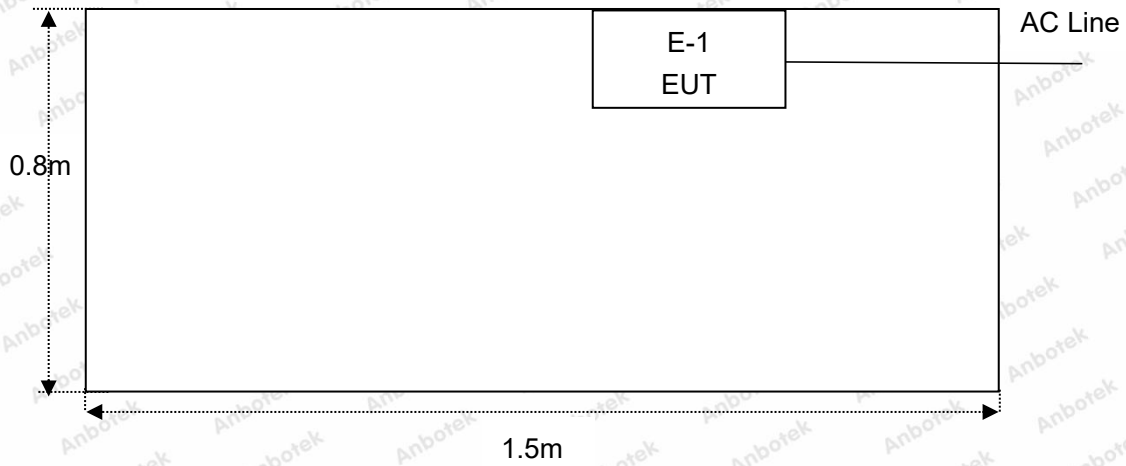

1.6. Test Equipment List

Item	Equipment	Manufacturer	Model No.	Serial No.	Last Cal.	Cal. Interval
1.	L.I.S.N. Artificial Mains Network	Rohde & Schwarz	ENV216	100055	Jan. 18, 2024	1 Year
2.	Three Phase V-type Artificial Power Network	CYBERTEK	EM5040DT	E215040DT001	Jan. 18, 2024	1 Year
3.	EMI Test Receiver	Rohde & Schwarz	ESCI	100627	Oct. 12, 2023	1 Year
4.	EMI Test Receiver	Rohde & Schwarz	ESR26	101481	Jan. 23, 2024	1 Year
5.	MXA Spectrum Analysis	Agilent	N9020A	MY51170037	Oct. 12, 2023	1 Year
6.	EMI Preamplifier	SKET Electronic	LNPA-0118G -45	SKET-PA-002	Jan. 17, 2024	1 Year
7.	Double Ridged Horn Antenna	SCHWARZBECK	BBHA 9120D	02555	Oct. 16, 2022	3 Year
8.	Bilog Broadband Antenna	Schwarzbeck	VULB9163	345	Oct. 23, 2022	3 Year
9.	Loop Antenna	Schwarzbeck	FMZB1519B	00053	Oct. 12, 2023	1 Year
10.	Horn Antenna	A-INFO	LB-180400- KF	J211060628	Oct. 12, 2023	1 Year
11.	Pre-amplifier	SONOMA	310N	186860	Jan. 17, 2024	1 Year
12.	EMI Test Software EZ-EMC	SHURPLE	N/A	N/A	N/A	N/A
13.	MXA Spectrum Analysis	KEYSIGHT	N9020A	MY53280032	Oct. 12, 2023	1 Year
14.	MXG RF Vector Signal Generator	Agilent	N5182A	MY48180656	Oct. 12, 2023	1 Year
15.	Signal Generator	Agilent	E4421B	MY41000743	Oct. 12, 2023	1 Year
16.	DC Power Supply	IVYTECH	IV3605	1804D360510	Oct. 20, 2023	1 Year
17.	Constant Temperature Humidity Chamber	ZHONGJIAN	ZJ-KHWS80 B	N/A	Oct. 16, 2023	1 Year
18.	Spectrum Analyzer	Rohde & Schwarz	FSV40-N	102150	May. 06, 2024	1 Year



1.7. Measurement Uncertainty

Parameter	Uncertainty
Conducted emissions (AMN 150kHz~30MHz)	3.8dB
Occupied Bandwidth	925Hz
Conducted Output Power	0.76dB
Conducted Spurious Emission	1.24dB
Radiated spurious emissions (Below 30MHz)	3.53dB
Radiated spurious emissions (30MHz~1GHz)	Horizontal: 3.92dB; Vertical: 4.52dB
Radiated spurious emissions (above 1GHz)	1G-6GHz: 4.78dB; 6G-18GHz: 4.88dB 18G-40GHz: 5.68dB
The measurement uncertainty and decision risk evaluated according to AB/WI-RF-F-032. This uncertainty represents an expanded uncertainty expressed at approximately the 95% confidence level using a coverage factor of k=2.	

1.8. Description of Test Facility

The test facility is recognized, certified, or accredited by the following organizations:

FCC-Registration No.: 434132

Shenzhen Anbotek Compliance Laboratory Limited, EMC Laboratory has been registered and fully described in a report filed with the (FCC) Federal Communications Commission. The acceptance letter from the FCC is maintained in our files. Registration No. 434132.

ISED-Registration No.: 8058A

Shenzhen Anbotek Compliance Laboratory Limited, EMC Laboratory has been registered and fully described in a report filed with the (ISED) Innovation, Science and Economic Development Canada. The acceptance letter from the ISED is maintained in our files. Registration 8058A.

Test Location

Shenzhen Anbotek Compliance Laboratory Limited.

1/F, Building D, Sogood Science and Technology Park, Sanwei community, Hangcheng Street, Bao'an District, Shenzhen, Guangdong, China.



1.9.Disclaimer

1. The test report is invalid if not marked with the signatures of the persons responsible for preparing and approving the test report.
2. The test report is invalid if there is any evidence and/or falsification.
3. The results documented in this report apply only to the tested sample, under the conditions and modes of operation as described herein.
4. This document may not be altered or revised in any way unless done so by Anbotek and all revisions are duly noted in the revisions section.
5. Content of the test report, in part or in full, cannot be used for publicity and/or promotional purposes without prior written approval from the laboratory.
6. The authenticity of the information provided by the customer is the responsibility of the customer and the laboratory is not responsible for its authenticity.

The laboratory is only responsible for the data released by the laboratory, except for the part provided by the applicant.



2. Summary of Test Results

Standard Section	Test Item	Result
15.203/15.247(c)	Antenna Requirement	PASS
15.207	Conducted Emission	PASS
15.205/15.209	Radiated Spurious Emission and Band Edge	PASS
15.247(b)(3)	Maximum Conduct Output Power	PASS
15.247(a)(2)	6dB Bandwidth	PASS
N/A	99% Occupied Bandwidth	Report only
15.247(e)	Maximum Power Spectral Density	PASS
15.247(d)	Conducted Spurious Emission and Band Edge	PASS
Remark: "N/A" is an abbreviation for Not Applicable.		



3. Conducted Emission Test

3.1. Test Standard and Limit

Test Standard	FCC Part15 Section 15.207		
Test Limit	Frequency	Maximum RF Line Voltage (dBuV)	
		Quasi-peak Level	Average Level
	150kHz~500kHz	66 ~ 56 *	56 ~ 46 *
	500kHz~5MHz	56	46
5MHz~30MHz	60	50	

Remark:(1) *Decreasing linearly with logarithm of the frequency.
 (2) The lower limit shall apply at the transition frequency.

3.2. Test Setup

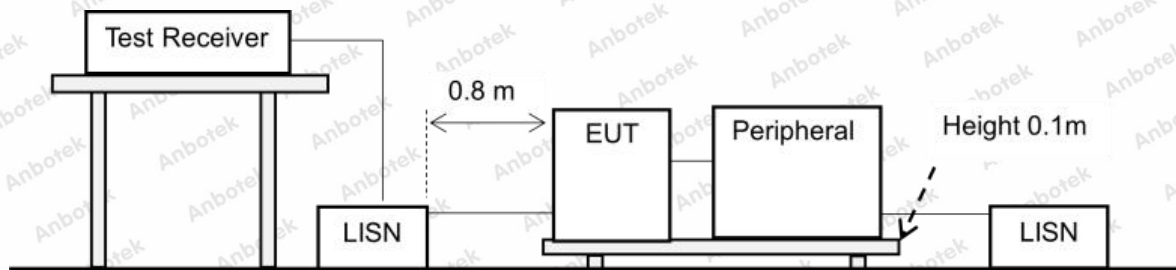

3.3. Test Procedure

The EUT system is connected to the power mains through a line impedance stabilization network (L.I.S.N.). This provides a 50ohm coupling impedance for the EUT system. Please refer the block diagram of the test setup and photographs. Both sides of AC line are checked to find out the maximum conducted emission. In order to find the maximum emission levels, the relative positions of equipment and all of the interface cables shall be changed according to FCC ANSI C63.10: 2020 on Conducted Emission Measurement.

The bandwidth of test receiver (ESCI) set at 9kHz.

The frequency range from 150kHz to 30MHz is checked.

3.4. Test Data

During the test, pre-scan all modes, only the worst case is recorded in the report.

AC conducted emission pre-test at both at AC 120V/60Hz and AC 240V/60Hz modes, recorded worst case AC 120V/60Hz.

Please to see the following pages.



Conducted Emission Test Data

Test Site: 1# Shielded Room
 Operating Condition: BLE_2M (2402MHz)
 Test Specification: AC 120V, 60Hz
 Comment: Live Line
 Temp.(°C)/Hum.(%RH): 23.5°C/57%RH

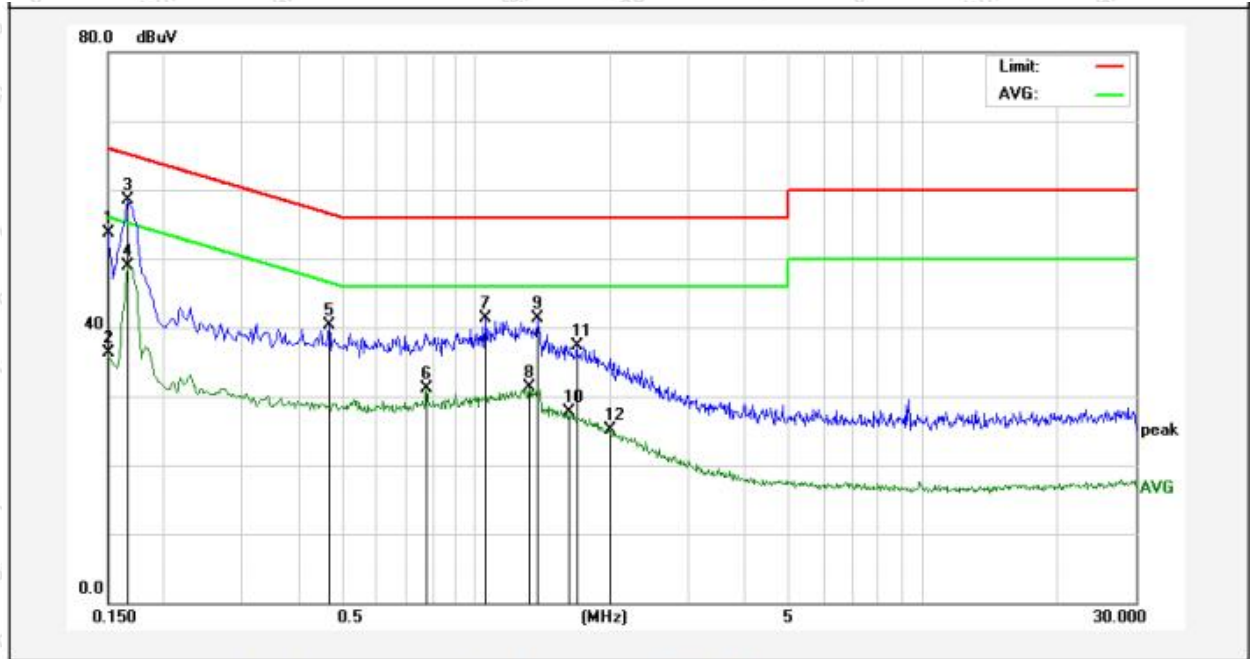

No.	Freq. (MHz)	Reading (dBuV)	Factor (dB)	Result (dBuV)	Limit (dBuV)	Over Limit (dB)	Detector	Remark
1	0.1499	35.82	17.82	53.64	66.00	-12.36	QP	
2	0.1499	18.39	17.82	36.21	56.00	-19.79	AVG	
3	0.1660	40.61	17.83	58.44	65.15	-6.71	QP	
4	0.1660	31.15	17.83	48.98	55.15	-6.17	AVG	
5	0.4700	22.50	17.85	40.35	56.51	-16.16	QP	
6	0.7780	13.17	17.87	31.04	46.00	-14.96	AVG	
7	1.0540	23.50	17.86	41.36	56.00	-14.64	QP	
8	1.3180	13.41	17.86	31.27	46.00	-14.73	AVG	
9	1.3779	23.36	17.86	41.22	56.00	-14.78	QP	
10	1.6180	9.76	17.85	27.61	46.00	-18.39	AVG	
11	1.6860	19.42	17.85	37.27	56.00	-18.73	QP	
12	1.9820	7.26	17.85	25.11	46.00	-20.89	AVG	



Conducted Emission Test Data

Test Site: 1# Shielded Room
 Operating Condition: BLE_2M (2402MHz)
 Test Specification: AC 120V, 60Hz
 Comment: Neutral Line
 Temp.(°C)/Hum.(%RH): 23.5°C/57%RH

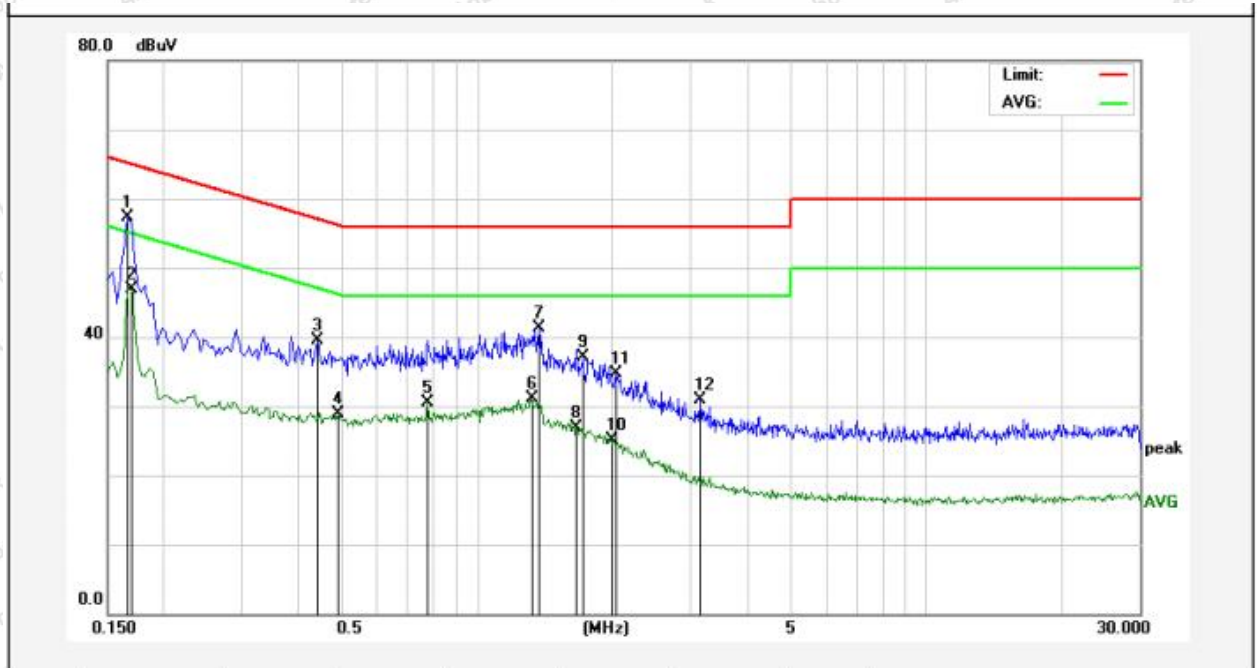

No.	Freq. (MHz)	Reading (dBuV)	Factor (dB)	Result (dBuV)	Limit (dBuV)	Over Limit (dB)	Detector	Remark
1	0.1658	39.41	17.83	57.24	65.16	-7.92	QP	
2	0.1693	29.09	17.83	46.92	54.99	-8.07	AVG	
3	0.4395	21.59	17.83	39.42	57.07	-17.65	QP	
4	0.4889	11.00	17.86	28.86	46.19	-17.33	AVG	
5	0.7752	12.62	17.87	30.49	46.00	-15.51	AVG	
6	1.3166	13.26	17.86	31.12	46.00	-14.88	AVG	
7	1.3736	23.50	17.86	41.36	56.00	-14.64	QP	
8	1.6625	9.08	17.85	26.93	46.00	-19.07	AVG	
9	1.7160	19.17	17.85	37.02	56.00	-18.98	QP	
10	2.0011	7.25	17.85	25.10	46.00	-20.90	AVG	
11	2.0440	16.79	17.85	34.64	56.00	-21.36	QP	
12	3.1396	13.01	17.85	30.86	56.00	-25.14	QP	



4. Radiated Spurious Emission and Band Edge Test

4.1. Test Standard and Limit

Test Standard	FCC Part15 C Section 15.209 and 15.205				
Test Limit	Frequency (MHz)	Field strength (microvolt/meter)	Limit (dBuV/m)	Remark	Measurement distance (m)
	0.009MHz~0.490MHz	2400/F(kHz)	-	-	300
	0.490MHz-1.705MHz	24000/F(kHz)	-	-	30
	1.705MHz-30MHz	30	-	-	30
	30MHz~88MHz	100	40.0	Quasi-peak	3
	88MHz~216MHz	150	43.5	Quasi-peak	3
	216MHz~960MHz	200	46.0	Quasi-peak	3
	960MHz~1000MHz	500	54.0	Quasi-peak	3
	Above 1000MHz	500	54.0	Average	3
-		74.0	Peak	3	

Remark:

(1)The lower limit shall apply at the transition frequency.

(2) 15.35(b), Unless otherwise specified, the limit on peak radio frequency emissions is 20dB above the maximum permitted average emission limit applicable to the equipment under test. This peak limit applies to the total peak emission level radiated by the device.

4.2. Test Setup

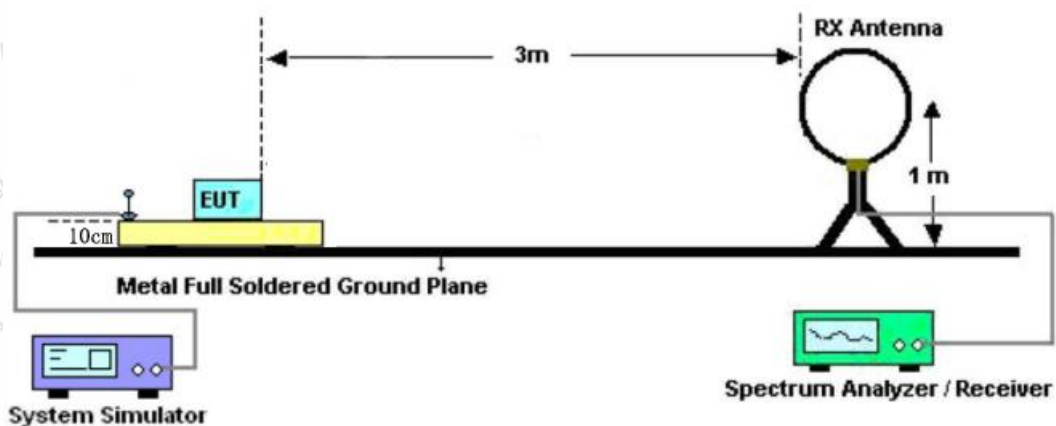

Figure 1. Below 30MHz



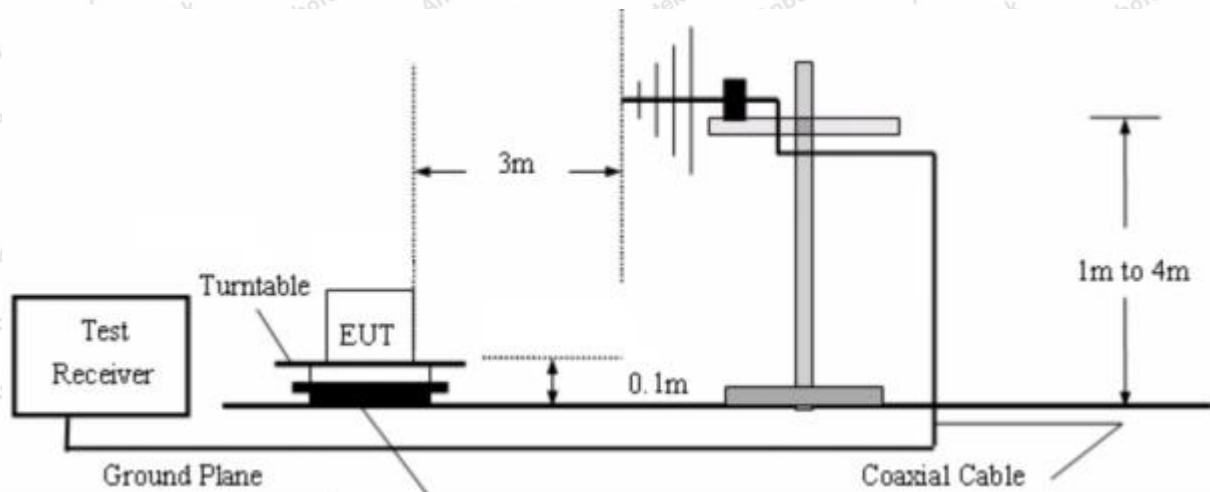

Figure 2. 30MHz to 1GHz

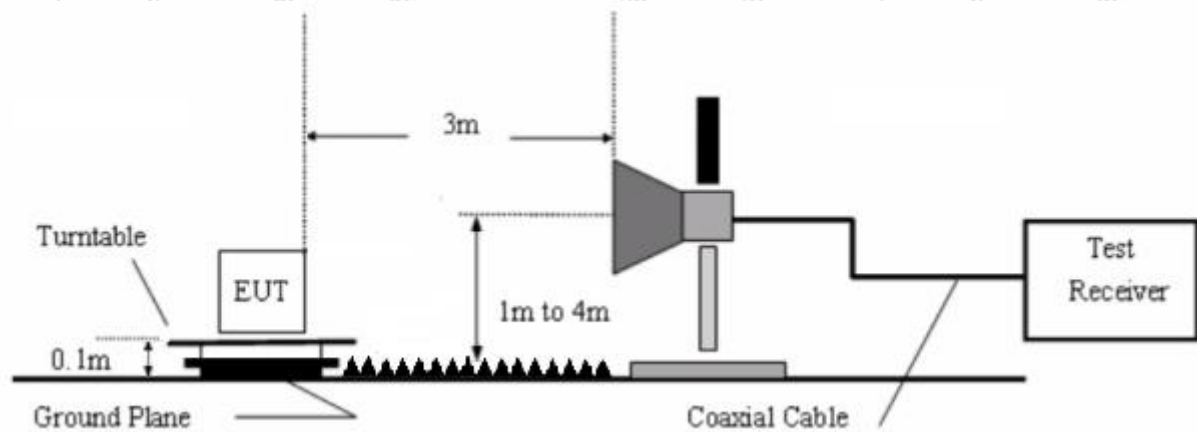

Figure 3. Above 1 GHz

4.3. Test Procedure

For below 1GHz: The EUT is placed on a turntable, which is 0.1m above the ground plane.

For above 1GHz: The EUT is placed on a turntable, which is 0.1m above the ground plane.

The turn table can rotate 360 degrees to determine the position of the maximum emission level. The EUT is set 3 meters away from the receiving antenna which is mounted on a antenna tower. The antenna can be moved up and down from 1 to 4 meters to find out the maximum emission level. Rotated the EUT through three orthogonal axes to determine the maximum emissions, both horizontal and vertical polarization of the antenna are set on test. The EUT is tested in 9*6*6 Chamber. The device is evaluated in xyz orientation.

For the radiated emission test above 1GHz:

Place the measurement antenna away from each area of the EUT determined to be a source of emissions at the specified measurement distance, while keeping the measurement antenna aimed at the source of emissions at each frequency of significant emissions, with polarization oriented for maximum response. The measurement antenna may have to be higher or lower than the EUT, depending on the radiation pattern of the emission and staying aimed at the emission source for receiving the maximum signal. The final measurement antenna elevation shall be that which maximizes the emissions. The measurement antenna elevation for maximum emissions shall be restricted to a



range of heights of from 1 m to 4 m above the ground or reference ground plane.

For 9kHz to 150kHz, Set the spectrum analyzer as:

RBW = 200Hz, VBW = 1kHz, Detector= Quasi-Peak, Trace mode= Max hold, Sweep- auto couple.

For 150kHz to 30MHz, Set the spectrum analyzer as:

RBW = 9KHz, VBW = 30kHz, Detector= Quasi-Peak, Trace mode= Max hold, Sweep- auto couple.

For 30MHz to 1000MHz, Set the spectrum analyzer as:

RBW = 100kHz, VBW = 300kHz, Detector= Quasi-Peak, Trace mode= Max hold, Sweep- auto couple.

For above 1GHz, Set the spectrum analyzer as:

RBW = 1MHz, VBW = 3MHz, Detector= Peak, Trace mode= Max hold, Sweep- auto couple.

For average measurement:

–VBW=3*RBW, Detector= RMS, When duty cycle is no less than 98 percent

–VBW=3*RBW, Detector= RMS, When duty cycle is less than 98 percent and duty cycle is constant, average=peak level+correction factor(20log(duty cycle)).

–VBW \geq 1/T, when duty cycle is less than 98 percent and duty cycle is not constant, where T is the minimum transmission duration over which the transmitter is on and is transmitting at its maximum power control level for the tested mode of operation, so refer to this clause duty cycle result.

4.4. Test Data

PASS

During the test, Pre-scan all kind of the place mode (X-axis, Y-axis, Z-axis), and found the X-axis is the worst case.

The test results of 9kHz-30MHz was attenuated more than 20dB below the permissible limits, so the results don't record in the report.

During the test, pre-scan all modes, only the worst case is recorded in the report.



Test Results (30~1000MHz)

Test Mode: BLE_2M (2402MHz)
 Power Source: AC 120V, 60Hz
 Polarization: Horizontal
 Temp.(°C)/Hum.(%RH): 20.3°C/46%RH

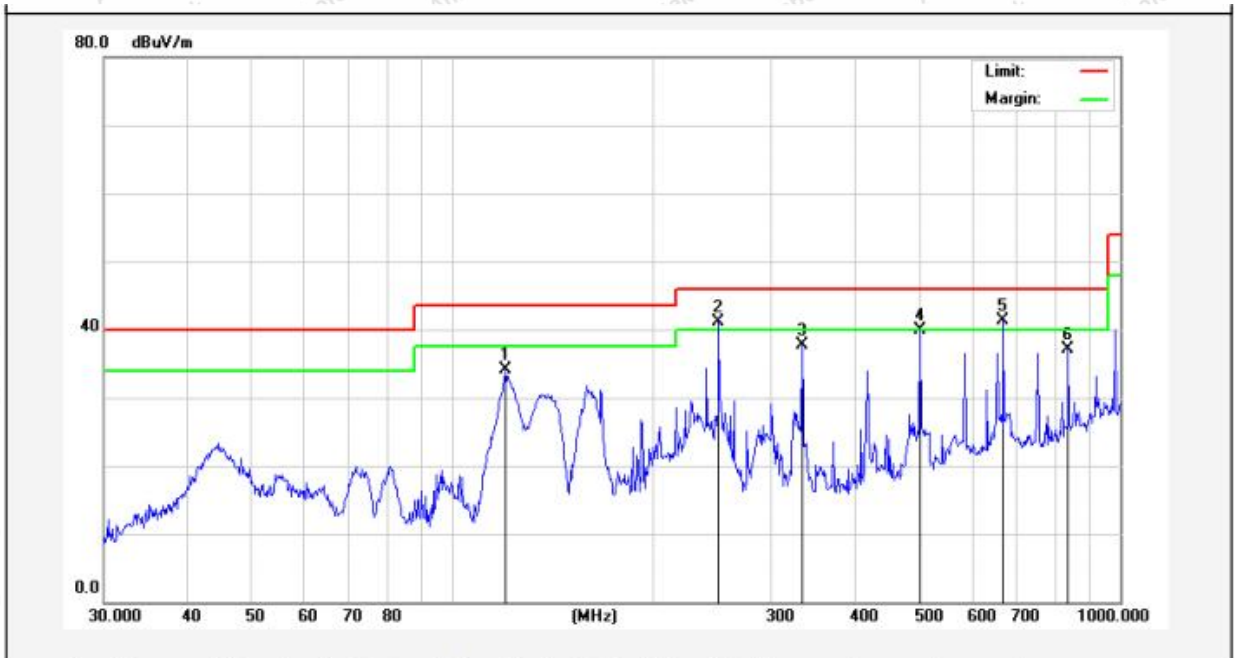

No.	Freq. (MHz)	Reading (dBuV)	Factor (dB/m)	Result (dBuV/m)	Limit (dBuV/m)	Over Limit (dB)	Detector
1	119.8556	58.09	-23.94	34.15	43.50	-9.35	QP
2	250.3012	62.58	-21.47	41.11	46.00	-4.89	QP
3	333.6867	54.03	-16.38	37.65	46.00	-8.35	QP
4	501.1790	53.61	-13.72	39.89	46.00	-6.11	QP
5	668.1423	51.79	-10.39	41.40	46.00	-4.60	QP
6	836.2443	44.79	-7.70	37.09	46.00	-8.91	QP



Test Results (30~1000MHz)

Test Mode: BLE_2M (2402MHz)

Power Source: AC 120V, 60Hz

Polarization: Vertical

Temp.(°C)/Hum.(%RH): 20.3°C/46%RH

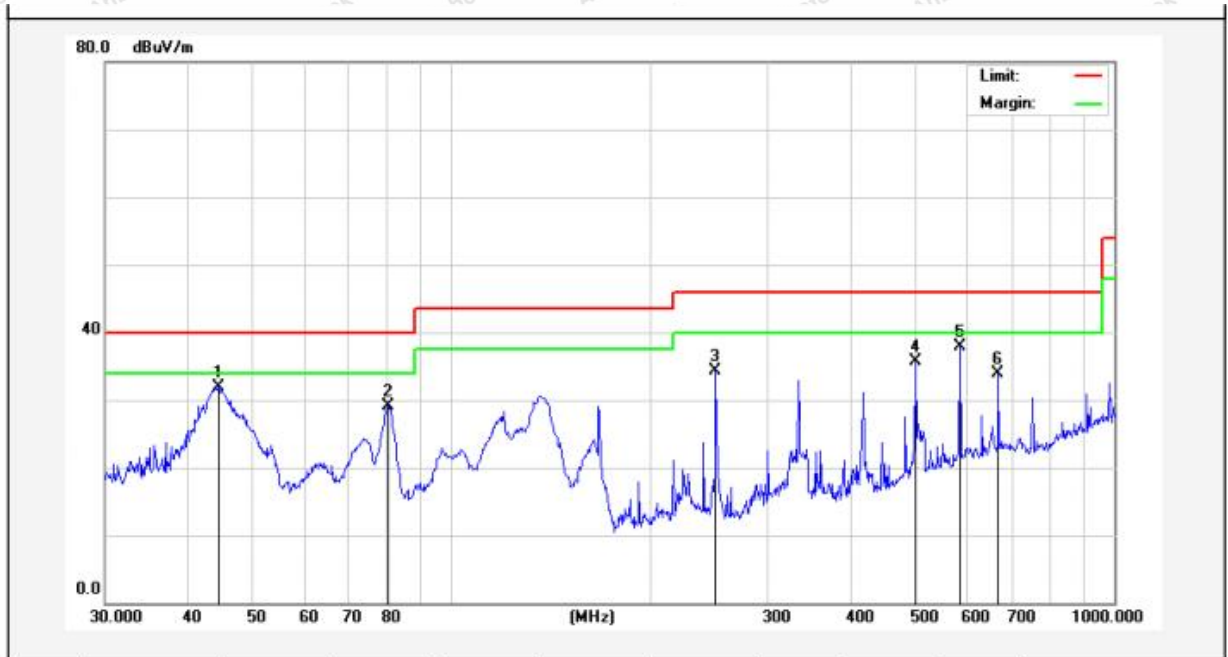

No.	Freq. (MHz)	Reading (dBuV)	Factor (dB/m)	Result (dBuV/m)	Limit (dBuV/m)	Over Limit (dB)	Detector
1	44.4308	46.97	-14.99	31.98	40.00	-8.02	QP
2	80.3619	48.41	-19.26	29.15	40.00	-10.85	QP
3	250.3012	52.22	-17.92	34.30	46.00	-11.70	QP
4	501.1790	47.96	-12.22	35.74	46.00	-10.26	QP
5	584.7895	48.72	-10.90	37.82	46.00	-8.18	QP
6	668.1423	44.32	-10.39	33.93	46.00	-12.07	QP



Test Results (1GHz-25GHz)

Test Mode: CH00			Test channel: Lowest			
Peak value:						
Frequency (MHz)	Reading (dBuV)	Factor (dB/m)	Result (dBuV/m)	Limit Line (dBuV/m)	Over Limit (dB)	polarization
4804.00	28.62	15.27	43.89	74.00	-30.11	Vertical
7206.00	28.65	18.09	46.74	74.00	-27.26	Vertical
9608.00	29.56	23.76	53.32	74.00	-20.68	Vertical
12010.00	*			74.00		Vertical
14412.00	*			74.00		Vertical
4804.00	28.27	15.27	43.54	74.00	-30.46	Horizontal
7206.00	29.24	18.09	47.33	74.00	-26.67	Horizontal
9608.00	28.18	23.76	51.94	74.00	-22.06	Horizontal
12010.00	*			74.00		Horizontal
14412.00	*			74.00		Horizontal
Average value:						
Frequency (MHz)	Reading (dBuV)	Factor (dB/m)	Result (dBuV/m)	Limit (dBuV/m)	Over Limit (dB)	polarization
4804.00	16.89	15.27	32.16	54.00	-21.84	Vertical
7206.00	17.70	18.09	35.79	54.00	-18.21	Vertical
9608.00	19.03	23.76	42.79	54.00	-11.21	Vertical
12010.00	*			54.00		Vertical
14412.00	*			54.00		Vertical
4804.00	16.60	15.27	31.87	54.00	-22.13	Horizontal
7206.00	18.27	18.09	36.36	54.00	-17.64	Horizontal
9608.00	17.69	23.76	41.45	54.00	-12.55	Horizontal
12010.00	*			54.00		Horizontal
14412.00	*			54.00		Horizontal



Test Results (1GHz-25GHz)

Test Mode: CH19				Test channel: Middle		
Peak value:						
Frequency (MHz)	Reading (dBuV)	Factor (dB/m)	Result (dBuV/m)	Limit Line (dBuV/m)	Over Limit (dB)	polarization
4880.00	28.17	15.42	43.59	74.00	-30.41	Vertical
7320.00	28.62	18.02	46.64	74.00	-27.36	Vertical
9760.00	29.06	23.80	52.86	74.00	-21.14	Vertical
12200.00	*			74.00		Vertical
14640.00	*			74.00		Vertical
4880.00	28.08	15.42	43.50	74.00	-30.50	Horizontal
7320.00	29.11	18.02	47.13	74.00	-26.87	Horizontal
9760.00	27.90	23.80	51.70	74.00	-22.30	Horizontal
12200.00	*			74.00		Horizontal
14640.00	*			74.00		Horizontal
Average value:						
Frequency (MHz)	Reading (dBuV)	Factor (dB/m)	Result (dBuV/m)	Limit (dBuV/m)	Over Limit (dB)	polarization
4880.00	16.98	15.42	32.40	54.00	-21.60	polarization
7320.00	17.56	18.02	35.58	54.00	-18.42	Vertical
9760.00	18.88	23.80	42.68	54.00	-11.32	Vertical
12200.00	*			54.00		Vertical
14640.00	*			54.00		Vertical
4880.00	16.71	15.42	32.13	54.00	-21.87	Vertical
7320.00	18.62	18.02	36.64	54.00	-17.36	Horizontal
9760.00	17.99	23.80	41.79	54.00	-12.21	Horizontal
12200.00	*			54.00		Horizontal
14640.00	*			54.00		Horizontal



Test Results (1GHz-25GHz)

Test Mode: CH39				Test channel: Highest		
Peak value:						
Frequency (MHz)	Reading (dBuV)	Factor (dB/m)	Result (dBuV/m)	Limit Line (dBuV/m)	Over Limit (dB)	polarization
4960.00	28.30	15.58	43.88	74.00	-30.12	Vertical
7440.00	28.78	17.93	46.71	74.00	-27.29	Vertical
9920.00	29.76	23.83	53.59	74.00	-20.41	Vertical
12400.00	*			74.00		Vertical
14880.00	*			74.00		Vertical
4960.00	28.22	15.58	43.80	74.00	-30.20	Horizontal
7440.00	29.32	17.93	47.25	74.00	-26.75	Horizontal
9920.00	28.28	23.83	52.11	74.00	-21.89	Horizontal
12400.00	*			74.00		Horizontal
14880.00	*			74.00		Horizontal
Average value:						
Frequency (MHz)	Reading (dBuV)	Factor (dB/m)	Result (dBuV/m)	Limit (dBuV/m)	Over Limit (dB)	polarization
4960.00	18.10	15.58	33.68	54.00	-20.32	Vertical
7440.00	18.83	17.93	36.76	54.00	-17.24	Vertical
9920.00	19.53	23.83	43.36	54.00	-10.64	Vertical
12400.00	*			54.00		Vertical
14880.00	*			54.00		Vertical
4960.00	17.89	15.58	33.47	54.00	-20.53	Horizontal
7440.00	19.42	17.93	37.35	54.00	-16.65	Horizontal
9920.00	18.14	23.83	41.97	54.00	-12.03	Horizontal
12400.00	*			54.00		Horizontal
14880.00	*			54.00		Horizontal

Remark:

- 1.Result =Reading + Factor
2. "*" means the test results were attenuated more than 20dB below the permissible limits, so the results don't record in the report.
3. During the test, pre-scan the BLE_1M&BLE_2M, and found the BLE_1M is worse case, the report only record this mode.



Radiated Band Edge:

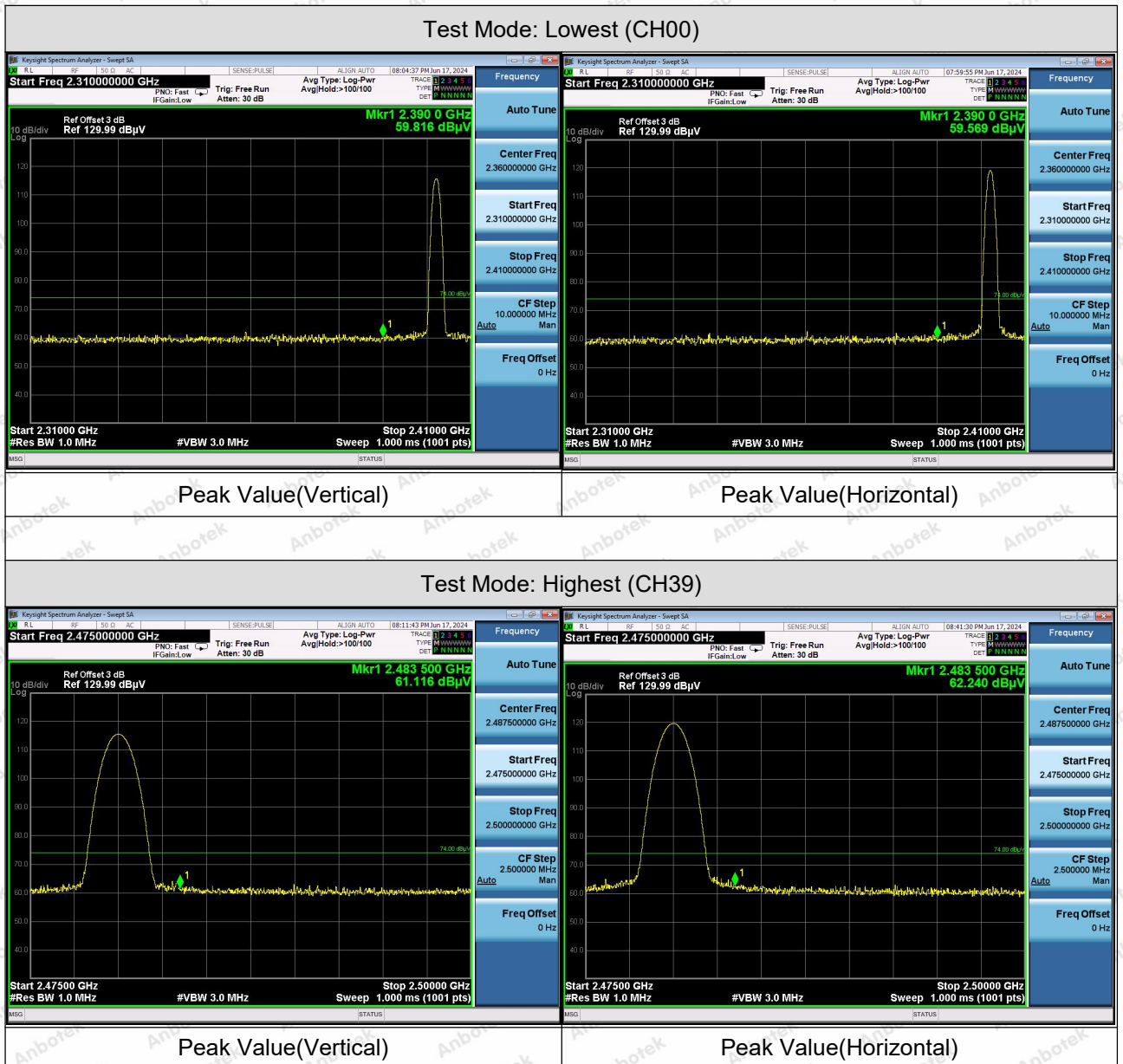

Peak Value(Vertical)

Peak Value(Horizontal)

Peak Value(Vertical)

Peak Value(Horizontal)

Remark:

1. During the test, pre-scan the BLE_1M and BLE_2M and found the BLE_2M modulation is worse case, the report only record this mode.

Test for Duty Cycle.

Please refer to Appendix G of the Appendix Test Data.



5. Maximum Conducted Output Power Test

5.1. Test Standard and Limit

Test Standard	FCC Part15 C Section 15.247 (b)(3)
Test Limit	1W (30dBm)

5.2. Test Setup

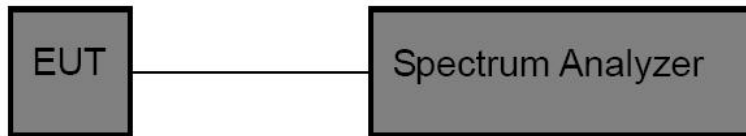

5.3. Test Procedure

This procedure shall be used when the measurement instrument has available a resolution bandwidth that is greater than the DTS bandwidth.

1. Set the RBW \geq DTS bandwidth.
2. Set the VBW $\geq 3 \times$ RBW.
3. Set the span $\geq 3 \times$ RBW.
4. Detector = peak.
5. Sweep time = auto couple.
6. Trace mode = max hold.
7. Allow trace to fully stabilize.
8. Use peak marker function to determine the peak amplitude level.

5.4. Test Data

Pass

Please refer to Appendix C of the Appendix Test Data.



6. 6dB Bandwidth and 99% Occupied Bandwidth Test

6.1. Test Standard and Limit

Test Standard	FCC Part15 C Section 15.247 (a)(2)
Test Limit	≥500kHz

6.2. Test Setup

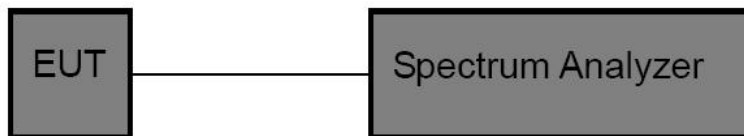

6.3. Test Procedure

- Place the EUT on the table and set it in the transmitting mode.
- Remove the antenna from the EUT and then connect a low loss RF cable from the antenna port to the spectrum analyzer.
- Set the spectrum analyzer as:
 - DTS Bandwidth:
 - RBW = 100kHz, VBW≥3*RBW
 - Detector= Peak
 - Trace mode= Max hold.
 - Sweep- auto couple.
 - Mark the peak frequency and -6dB (upper and lower) frequency.
 - Occupied Bandwidth:
 - RBW = 1% to 5% OBW, VBW≥3*RBW
 - Detector= Peak
 - Trace mode= Max hold.
 - Sweep- auto couple.
- Repeat until all the rest channels are investigated.

6.4. Test Data

Pass

Please refer to Appendix A&B of the Appendix Test Data.



7. Power Spectral Density Test

7.1. Test Standard and Limit

Test Standard	FCC Part15 C Section 15.247 (e)
Test Limit	8dBm/3KHz

7.2. Test Setup

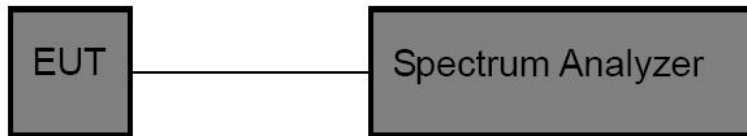

7.3. Test Procedure

1. Place the EUT on the table and set it in transmitting mode. Remove the antenna from the EUT and then connect a low loss RF cable from the antenna port to the spectrum analyzer.
2. Set the spectrum analyzer as RBW = 3kHz, VBW $\geq 3 \times$ RBW, Span = 1.5x DTS BW
3. Record the max. reading.
4. Repeat the above procedure until the measurements for all frequencies are completed.

7.4. Test Data

Pass

Please refer to Appendix D of the Appendix Test Data.



8. Conducted Spurious Emission and Band Edge Test

8.1. Test Standard and Limit

Test Standard	FCC Part15 C Section 15.247 (d)
Test Limit	In any 100 kHz bandwidth outside the frequency bands in which the spread spectrum intentional radiator is operating, the radio frequency power that is produced by the intentional radiator shall be at least 20dB below that in the 100kHz bandwidth within the band that contains the highest level of the desired power, In addition, radiated emissions which fall in the restricted bands, as defined in §15.205(a), must also comply with the radiated emission limits specified in 15.209(a).

8.2. Test Setup

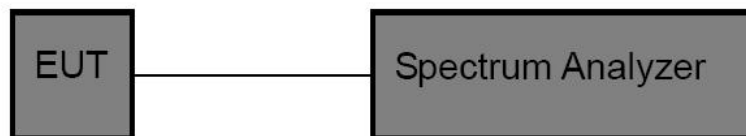

8.3. Test Procedure

Using the following spectrum analyzer setting:

1. Set the RBW = 100KHz.
2. Set the VBW = 300KHz.
3. Sweep time = auto couple.
4. Detector function = peak.
5. Trace mode = max hold.
6. Allow trace to fully stabilize.

8.4. Test Data

Pass

Please refer to Appendix E&F of the Appendix Test Data.



9. Antenna Requirement

9.1. Test Standard and Requirement

Test Standard	FCC Part15 Section 15.203 /247(c)
Requirement	<p>1) 15.203 requirement: An intentional radiator shall be designed to ensure that no antenna other than that furnished by the responsible party shall be used with the device. The use of a permanently attached antenna or of an antenna that uses a unique coupling to the intentional radiator, the manufacturer may design the unit so that a broken antenna can be replaced by the user, but the use of a standard antenna jack or electrical connector is prohibited.</p> <p>2) 15.247(c) (1)(i) requirement: Systems operating in the 2400-2483.5 MHz band that is used exclusively for fixed. Point-to-point operations may employ transmitting antennas with directional gain greater than 6dBi provided the maximum conducted output power of the intentional radiator is reduced by 1 dB for every 3 dB that the directional gain of the antenna exceeds 6 dBi.</p>

9.2. Antenna Connected Construction

The antenna is a Rod antenna which permanently attached, and the best case gain of the antenna is 5dBi . It complies with the standard requirement.



APPENDIX I -- TEST SETUP PHOTOGRAPH

Please refer to separated files Appendix I -- Test Setup Photograph_RF

APPENDIX II -- EXTERNAL PHOTOGRAPH

Please refer to separated files Appendix II -- External Photograph

APPENDIX III -- INTERNAL PHOTOGRAPH

Please refer to separated files Appendix III -- Internal Photograph

----- End of Report -----

