



TEST REPORT

47 CFR Part 15, Subpart C 15.247

Report Reference No.....: **CTL2404222131-WF02**

Compiled by: Happy Guo
(position+printed name+signature) (File administrators)

Tested by: Jack Wang
(position+printed name+signature) (Test Engineer)

Approved by: Ivan Xie
(position+printed name+signature) (Manager)



Product Name.....: VCI U1

Model/Type reference.....: ANCEL V5 BT

List Model(s)(HVIN): ANCEL V5 PRO, ANCEL V5 ELITE, ANCEL X5 BT, ANCEL X5 PRO, ANCEL X5 ELITE

Trade Mark.....: ANCEL

FCC ID.....: **2ASC7VCIU15**

Applicant's name.....: **OBDSpace TECHNOLOGY Co., LTD**

Address of applicant.....: Room D03, Building A, No.973,MinZhi Avenue LongHua district
ShenZhen China

Test Firm.....: **Shenzhen CTL Testing Technology Co., Ltd.**

Address of Test Firm.....: Floor 1-A, Baisha Technology Park, No.3011, Shahexi Road,
Nanshan District, Shenzhen, China 518055

Test specification.....:

Standard.....: **47 CFR Part 15, Subpart C 15.247:** Operation within the bands
902-928 MHz, 2400-2483.5 MHz and 5725-5850 MHz.

TRF Originator.....: Shenzhen CTL Testing Technology Co., Ltd.

Master TRF.....: Dated 2011-01

Date of receipt of test item.....: May 29, 2024

Date of Test Date.....: May 29, 2024-August 5, 2024

Date of Issue.....: August 6, 2024

Result.....: **Pass**

Shenzhen CTL Testing Technology Co., Ltd. All rights reserved.

This publication may be reproduced in whole or in part for non-commercial purposes as long as the Shenzhen CTL Testing Technology Co., Ltd. is acknowledged as copyright owner and source of the material. Shenzhen CTL Testing Technology Co., Ltd. takes no responsibility for and will not assume liability for damages resulting from the reader's interpretation of the reproduced material due to its placement and context.

TEST REPORT

Test Report No. :	CTL2404222131-WF02	August 6, 2024 Date of issue
--------------------------	---------------------------	---------------------------------

Equipment under Test : VCI U1

Sample No : CTL2404222131

Model /Type : ANCEL V5 BT

Listed Models : ANCEL V5 PRO, ANCEL V5 ELITE, ANCEL X5 BT,
ANCEL X5 PRO, ANCEL X5 ELITE

Applicant : **OBDSpace TECHNOLOGY Co., LTD**

Address : Room D03, Building A, No.973,MinZhi Avenue
LongHua district ShenZhen China

Manufacturer : **Shenzhen IDUTEX Tech Co., Ltd**

Address : Room 401, Building B11, Yintian Industrial Zone,
Yantian, Xixiang, Baoan, Shenzhen, China

Test result	Pass *
--------------------	---------------

* In the configuration tested, the EUT complied with the standards specified page 5.

The test results presented in this report relate only to the object tested.

This report shall not be reproduced, except in full, without the written approval of the issuing testing laboratory.

Table of Contents

Page

1. SUMMARY5

- 1.1. TEST STANDARDS 5
- 1.2. TEST DESCRIPTION 5
- 1.3. TEST FACILITY 6
- 1.4. STATEMENT OF THE MEASUREMENT UNCERTAINTY 6

2. GENERAL INFORMATION 8

- 2.1. ENVIRONMENTAL CONDITIONS 8
- 2.2. GENERAL DESCRIPTION OF EUT 8
- 2.3. DESCRIPTION OF TEST MODES AND TEST FREQUENCY 9
- 2.4. EQUIPMENTS USED DURING THE TEST 10
- 2.5. RELATED SUBMITTAL(S) / GRANT (S) 10
- 2.6. MODIFICATIONS 10

3. TEST CONDITIONS AND RESULTS 11

- 3.1. CONDUCTED EMISSIONS TEST 11
- 3.2. RADIATED EMISSIONS AND BAND EDGE 12
- 3.3. MAXIMUM CONDUCTED OUTPUT POWER 22
- 3.4. POWER SPECTRAL DENSITY 23
- 3.5. 6DB BANDWIDTH 24
- 3.6. OUT-OF-BAND EMISSIONS 25
- 3.7. ANTENNA REQUIREMENT 26

4. TEST SETUP PHOTOS OF THE EUT 27

5. PHOTOS OF THE EUT 27

1. SUMMARY

1.1. TEST STANDARDS

The tests were performed according to following standards:

[47 CFR Part 15, Subpart C 15.247](#) Frequency Hopping, Direct Spread Spectrum and Hybrid Systems that are in operation within the bands of 902-928 MHz, 2400-2483.5 MHz, and 5725-5850 MHz

[ANSI C63.10: 2013](#): American National Standard for Testing Unlicensed Wireless Devices

[KDB 558074 D01 v05r02](#): KDB558074 D01 15.247 Meas Guidance v05r02

1.2. Test Description

47 CFR Part 15, Subpart C 15.247		
47 CFR Part 15, Subpart C 15.207	AC Power Conducted Emission	N/A
47 CFR Part 15, Subpart C 15.247(a)(2)	6dB Bandwidth	PASS
47 CFR Part 15, Subpart C 15.247(d)	Spurious RF Conducted Emission	PASS
47 CFR Part 15, Subpart C 15.247(b)	Maximum Conducted Output Power	PASS
47 CFR Part 15, Subpart C 15.247(e)	Power Spectral Density	PASS
47 CFR Part 15, Subpart C 15.109/15.205/15.209	Radiated Emissions	PASS
47 CFR Part 15, Subpart C 15.247(d)	Band Edge	PASS
47 CFR Part 15, Subpart C 15.203/15.247 (b)	Antenna Requirement	PASS

1.3. Test Facility

1.3.1 Address of the test laboratory

Shenzhen CTL Testing Technology Co.,Ltd.

Floor 1-A, Baisha Technology Park, No.3011, Shahexi Road, Nanshan District, Shenzhen, China 518055

There is one 3m semi-anechoic chamber and two line conducted labs for final test. The Test Sites meet the requirements in documents ANSI C63.10 and CISPR 32/EN 55032 requirements.

1.3.2 Laboratory accreditation

The test facility is recognized, certified, or accredited by the following organizations:

CNAS-Lab Code: L7497

Shenzhen CTL Testing Technology Co., Ltd. has been assessed and proved to be in compliance with CNAS-CL01 Accreditation Criteria for Testing and Calibration Laboratories (identical to ISO/IEC 17025: 2017 General Requirements) for the Competence of Testing and Calibration Laboratories.

A2LA-Lab Cert. No. 4343.01

Shenzhen CTL Testing Technology Co., Ltd, EMC Laboratory has been accredited by A2LA for technical competence in the field of electrical testing, and proved to be in compliance with ISO/IEC 17025: 2017 General Requirements for the Competence of Testing and Calibration Laboratories and any additional program requirements in the identified field of testing.

IC Registration No.: 9618B

CAB identifier: CN0041

The 3m alternate test site of Shenzhen CTL Testing Technology Co., Ltd. EMC Laboratory has been registered by Innovation, Science and Economic Development Canada to test to Canadian radio equipment requirements with Registration No.: 9618B.

FCC-Registration No.: 399832

Designation No.: CN1216

Shenzhen CTL Testing Technology Co., Ltd. EMC Laboratory has been registered and fully described in a report filed with the (FCC) Federal Communications Commission. The acceptance letter from the FCC is maintained in our files. Registration 399832.

1.4. Statement of the measurement uncertainty

The data and results referenced in this document are true and accurate. The reader is cautioned that there may be errors within the calibration limits of the equipment and facilities. The measurement uncertainty was calculated for all measurements listed in this test report acc. to CISPR 16 - 4 "Specification for radio disturbance and immunity measuring apparatus and methods – Part 4: Uncertainty in EMC Measurements" and is documented in the Shenzhen CTL Testing Technology Co., Ltd. quality system acc. to DIN EN ISO/IEC 17025. Furthermore, component and process variability of devices similar to that tested may result in additional deviation. The manufacturer has the sole responsibility of continued compliance of the device.

Hereafter the best measurement capability for CTL laboratory is reported:

Test	Measurement Uncertainty	Notes
Transmitter power Radiated	±2.20 dB	(1)
Radiated Emission 9KHz~30MHz	±3.66dB	(1)
Radiated Emission 30~1000MHz	±4.10dB	(1)
Radiated Emission Above 1GHz	±4.32dB	(1)
DTS Bandwidth	±1.9%	(1)
Maximum Conducted Output Power	± 1.18 dB	(1)
Maximum Power Spectral Density Level	±0.98 dB	(1)

Band-edge	$\pm 1.21\text{dB}$	(1)
Unwanted Emissions In Non-restricted Freq Bands	9kHz-7GHz: $\pm 1.09\text{dB}$ 7GHz-26.5GHz: $\pm 3.27\text{dB}$	(1)

(1) This uncertainty represents an expanded uncertainty expressed at approximately the 95% confidence level using a coverage factor of $k=1.96$.

2. GENERAL INFORMATION

2.1. Environmental conditions

During the measurement the environmental conditions were within the listed ranges:

Normal Temperature:	25°C
Relative Humidity:	55 %
Air Pressure:	101 kPa

2.2. General Description of EUT

Product Name:	VCI U1
Model/Type reference:	ANCEL V5 BT
Power supply:	DC 8-30V
Bluetooth LE	
Supported type:	Bluetooth Low Energy
Modulation:	GFSK
Operation frequency:	2402MHz to 2480MHz
Channel number:	40
Channel separation:	2MHz
Antenna type:	Multilayer Chip Antenna
Antenna gain:	0dBi

Note1: For more details, please refer to the user's manual of the EUT.

Note2: Antenna gain provided by the applicant.

2.3. Description of Test Modes and Test Frequency

The Applicant provides communication tools software to control the EUT for staying in continuous transmitting (Duty Cycle more than 98%) and receiving mode for testing.

There are 40 channels provided to the EUT and Channel 00/19/39 were selected for BLE test.

Operation Frequency List :

Channel	Frequency (MHz)
00	2402
02	2404
03	2406
:	:
19	2440
:	:
37	2476
38	2478
39	2480

Note: The line display in grey were the channel selected for testing

2.4. Equipments Used during the Test

Conducted Emission						
Test Equipment	Manufacturer	Model No.	Serial No.	Previous calibration	Last Cal.	Cal.Due
EMI Test Receiver	ROHDE & SCHWARZ	ESCI	1166.5950.03	2023/05/04	2024/04/30	2025/04/29
LISN	ROHDE & SCHWARZ	ESH2-Z5	860014/010	2023/05/04	2024/04/30	2025/04/29
Limitator	ROHDE & SCHWARZ	ESH3-Z2	100408	2023/05/04	2024/04/30	2025/04/29
Software:						
Name of Software:			Version:			
ES-K1			V1.71			

Radiated Emission						
Test Equipment	Manufacturer	Model No.	Serial No.	Previous calibration	Last Cal.	Cal.Due
Active Loop Antenna	Da Ze	ZN30900A	/	2021/05/13	2024/04/30	2025/04/29
Double cone logarithmic antenna	Schwarzbeck	VULB 9168	824	/	2023/02/13	2026/02/12
Horn Antenna	Sunol Sciences Corp.	DRH-118	A062013	/	2021/12/23	2024/12/22
Horn Antenna	Ocean Microwave	OBH100400	26999002	/	2021/12/22	2024/12/21
Amplifier	MRT-AP01M06	MRT	S-001	2023/05/04	2024/04/30	2025/04/29
Amplifier	Agilent	8449B	3008A02306	2023/05/04	2024/04/30	2025/04/29
Amplifier	Brief&Smart	LNA-4018	2104197	2023/05/05	2024/05/03	2025/05/02
EMI Test Receiver	ROHDE & SCHWARZ	ESCI	1166.5950.03	2023/05/04	2024/04/30	2025/04/29
Spectrum Analyzer	RS	FSP	1164.4391.38	2023/05/05	2024/05/03	2025/05/02
Software:						
Name of Software:			Version:			
EZ_EMG(Below 1GHz)			V1.1.4.2			
EZ_EMG(Above 1GHz)			V1.1.4.2			

RF Conducted						
Test Equipment	Manufacturer	Model No.	Serial No.	Previous calibration	Last Cal.	Cal.Due
Spectrum Analyzer	Keysight	N9020A	MY53420874	2023/05/04	2024/05/01	2025/04/30
Temperature/Humidity Meter	Ji Yu	MC501	/	2023/05/09	2024/05/04	2025/05/03
Software:						
Name of Software:			Version:			
TST-PASS			V2.0			

2.5. Related Submittal(s) / Grant (s)

This submittal(s) (test report) is intended to comply with Section 15.247 of the FCC Part 15, Subpart C Rules.

2.6. Modifications

No modifications were implemented to meet testing criteria.

3. TEST CONDITIONS AND RESULTS

3.1. Conducted Emissions Test

LIMIT

FCC CFR Title 47 Part 15 Subpart C Section 15.207

Frequency range (MHz)	Limit (dBuV)	
	Quasi-peak	Average
0.15-0.5	66 to 56*	56 to 46*
0.5-5	56	46
5-30	60	50

* Decreases with the logarithm of the frequency.

TEST CONFIGURATION

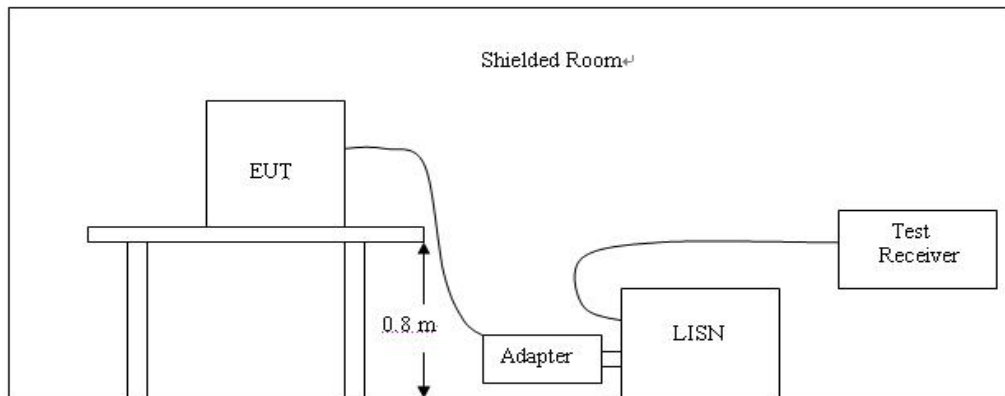

TEST PROCEDURE

1. The equipment was set up as per the test configuration to simulate typical actual usage per the user's manual. The EUT is a tabletop system; a wooden table with a height of 0.8 meters is used and is placed on the ground plane as per ANSI C63.10:2013.
2. Support equipment, if needed, was placed as per ANSI C63.10:2013.
3. All I/O cables were positioned to simulate typical actual usage as per ANSI C63.10:2013.
4. The adapter received AC120V/60Hz power through a Line Impedance Stabilization Network (LISN) which supplied power source and was grounded to the ground plane.
5. All support equipments received AC power from a second LISN, if any.
6. The EUT test program was started. Emissions were measured on each current carrying line of the EUT using a spectrum Analyzer / Receiver connected to the LISN powering the EUT. The LISN has two monitoring points: Line 1 (Hot Side) and Line 2 (Neutral Side). Two scans were taken: one with Line 1 connected to Analyzer / Receiver and Line 2 connected to a 50 ohm load; the second scan had Line 1 connected to a 50 ohm load and Line 2 connected to the Analyzer / Receiver.
7. Analyzer / Receiver scanned from 150 KHz to 30MHz for emissions in each of the test modes.
8. During the above scans, the emissions were maximized by cable manipulation.

TEST RESULTS

The DC power supply device of this product is not applicable to this test item.

3.2. Radiated Emissions and Band Edge

Limit

For intentional device, according to § 15.209(a), the general requirement of field strength of radiated emission out of authorized band shall not exceed the following table at a 3 meters measurement distance.

In addition, radiated emissions which fall in the restricted bands, as defined in §15.205(a), must also comply with the radiated emission limits specified in §15.209(a)

Radiated emission limits

Frequency (MHz)	Distance (Meters)	Radiated (dB μ V/m)	Radiated (μ V/m)
0.009-0.49	3	$20\log(2400/F(\text{KHz})) + 40\log(300/3)$	$2400/F(\text{KHz})$
0.49-1.705	3	$20\log(24000/F(\text{KHz})) + 40\log(30/3)$	$24000/F(\text{KHz})$
1.705-30	3	$20\log(30) + 40\log(30/3)$	30
30-88	3	40.0	100
88-216	3	43.5	150
216-960	3	46.0	200
Above 960	3	54.0	500

TEST CONFIGURATION

(A) Radiated Emission Test Set-Up, Frequency Below 30MHz

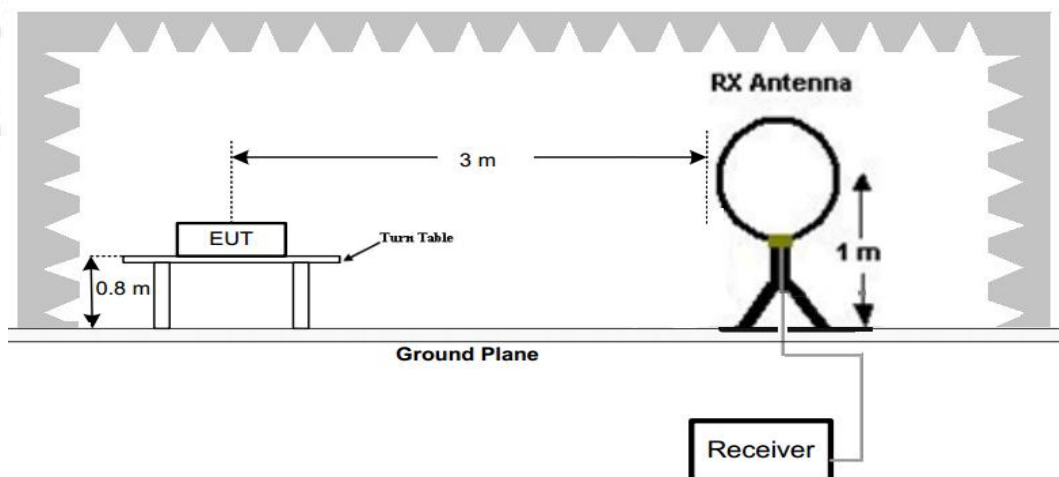

(B) Radiated Emission Test Set-Up, Frequency below 1000MHz

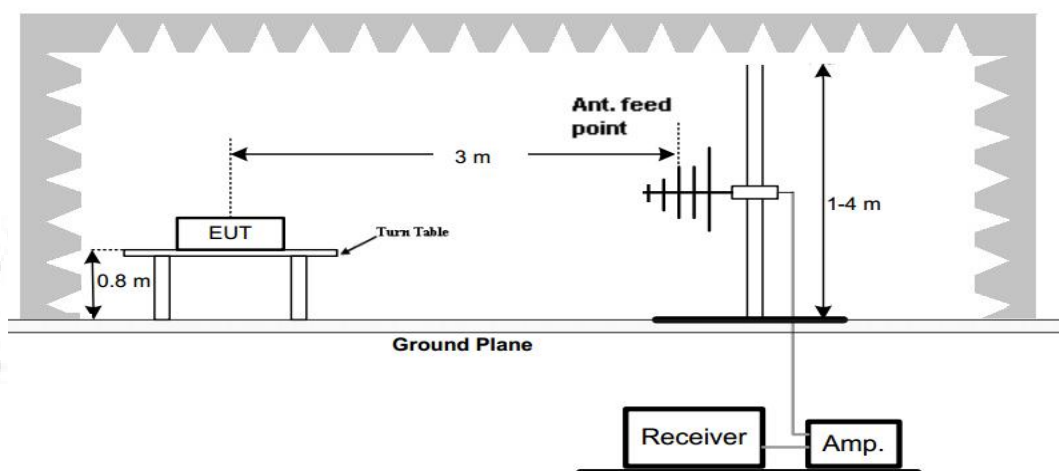

(C) Radiated Emission Test Set-Up, Frequency above 1000MHz

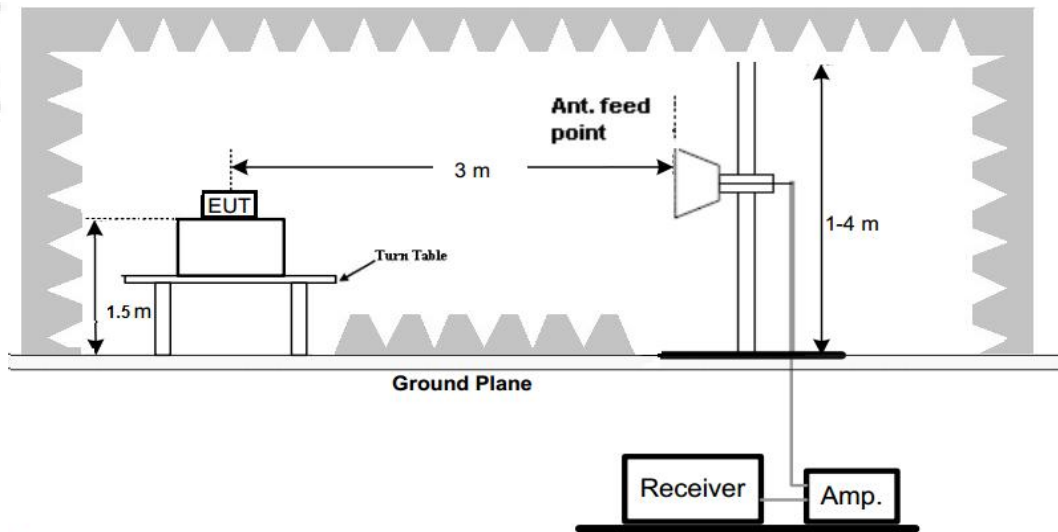
**Test Procedure**

1. Below 1GHz measurement the EUT is placed on a turntable which is 0.8m above ground plane, and above 1GHz measurement EUT was placed on a low permittivity and low loss tangent turn table which is 1.5m above ground plane.
2. Maximum procedure was performed by raising the receiving antenna from 1m to 4m and rotating the turn table from 0° to 360° to acquire the highest emissions from EUT
3. And also, each emission was to be maximized by changing the polarization of receiving antenna both horizontal and vertical.
4. Repeat above procedures until all frequency measurements have been completed.
5. The EUT was pretested with 3 orientations placed on the table for the radiated emission measurement –X, Y, and Z-plane. The X-plane results were found as the worst case and were shown in this report.

TEST RESULTS

Remark:

1. For below 1GHz testing recorded worst at BLE low channel.
2. Radiated emission test from 9 KHz to 10th harmonic of fundamental was verified, Found the emission level are attenuated 20dB below the limits from 9 kHz to 30MHz, so it does not recorded in report.

For 30MHz-1GHz

Horizontal



Shenzhen CTL Testing Technology Co., Ltd
Tel: +86-755-89486194

Radiated Emission Measurement

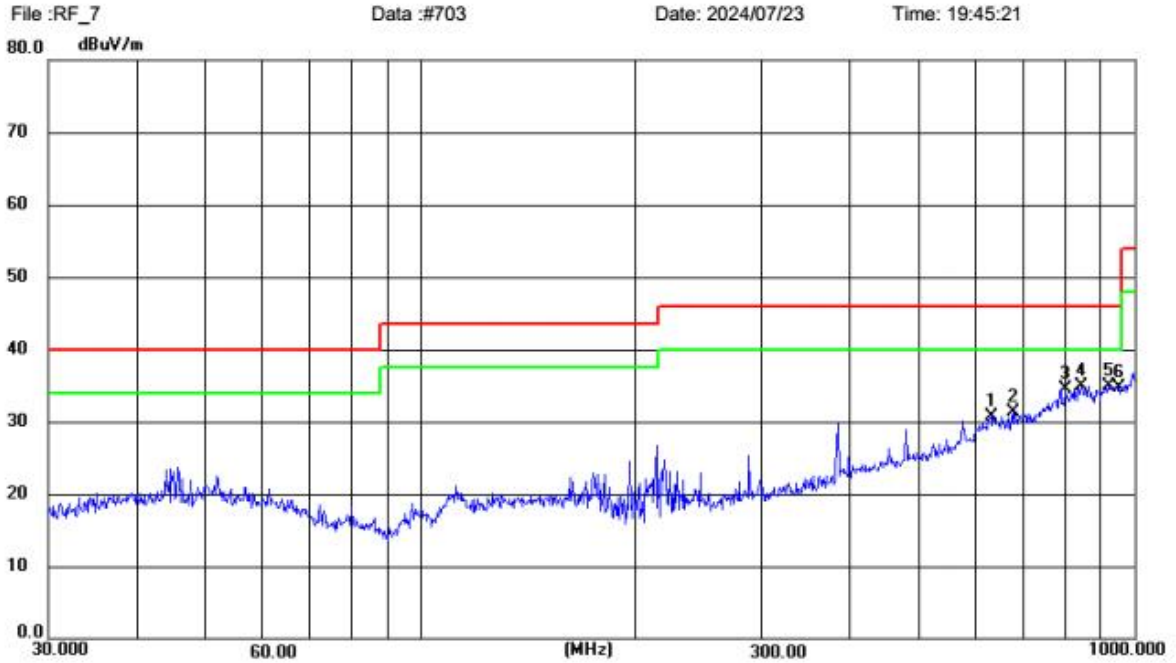

Site LAB Chamber 2 Polarization: **Horizontal** Temperature: 25(C)
 Limit: FCC Part15 RE-Class C_30-1000MHz Power: Humidity: 50 %
 EUT: Distance: 3m
 M/N: ANCEL V5 BT
 Mode: BLE1M 2402MHz
 Note: OBDSpace TECHNOLOGY CO.,LTD

No.	Frequency (MHz)	Reading (dBuV)	Factor (dB/m)	Level (dBuV/m)	Limit (dBuV/m)	Margin (dB)	Detector	Height (cm)	Azimuth (deg.)	P/F	Remark
1	629.4772	7.48	23.27	30.75	46.00	15.25	peak	100	355	P	
2	679.3641	7.79	23.44	31.23	46.00	14.77	peak	100	40	P	
3	801.4350	7.92	26.64	34.56	46.00	11.44	peak	100	113	P	
4	843.2377	7.59	27.29	34.88	46.00	11.12	peak	100	177	P	
5	920.0927	6.95	28.00	34.95	46.00	11.05	peak	100	208	P	
6	953.7644	6.45	28.34	34.79	46.00	11.21	peak	100	281	P	

Vertical



Shenzhen CTL Testing Technology Co., Ltd
Tel: +86-755-89486194

Radiated Emission Measurement

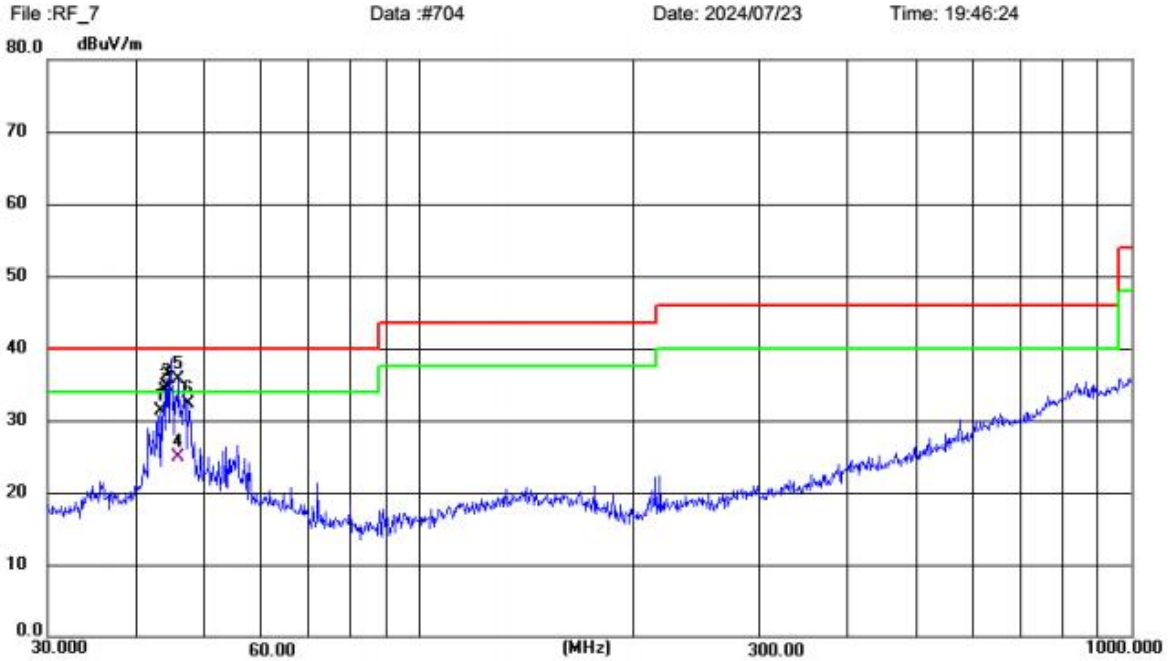

Site LAB Chamber 2 Polarization: **Vertical** Temperature: 25(C)
 Limit: FCC Part15 RE-Class C_30-1000MHz Power: Humidity: 50 %
 EUT: Distance: 3m
 M/N: ANCEL V5 BT
 Mode: BLE1M 2402MHz
 Note: OBDSpace TECHNOLOGY CO.,LTD

No.	Frequency (MHz)	Reading (dBuV)	Factor (dB/m)	Level (dBuV/m)	Limit (dBuV/m)	Margin (dB)	Detector	Height (cm)	Azimuth (deg.)	P/F	Remark
1	43.2585	16.54	14.77	31.31	40.00	8.69	peak	100	330	P	
2	43.9080	19.27	14.90	34.17	40.00	5.83	peak	100	109	P	
3	44.1783	19.77	14.91	34.68	40.00	5.32	peak	100	4	P	
4	45.8445	10.14	14.82	24.96	40.00	15.04	QP	100	360	P	
5	45.9760	20.97	14.80	35.77	40.00	4.23	peak	100	78	P	
6	47.3670	17.56	14.80	32.36	40.00	7.64	peak	100	57	P	

For 1GHz to 25GHz

Horizontal



Shenzhen CTL Testing Technology Co., Ltd
Tel: +86-755-89486194

Radiated Emission Measurement

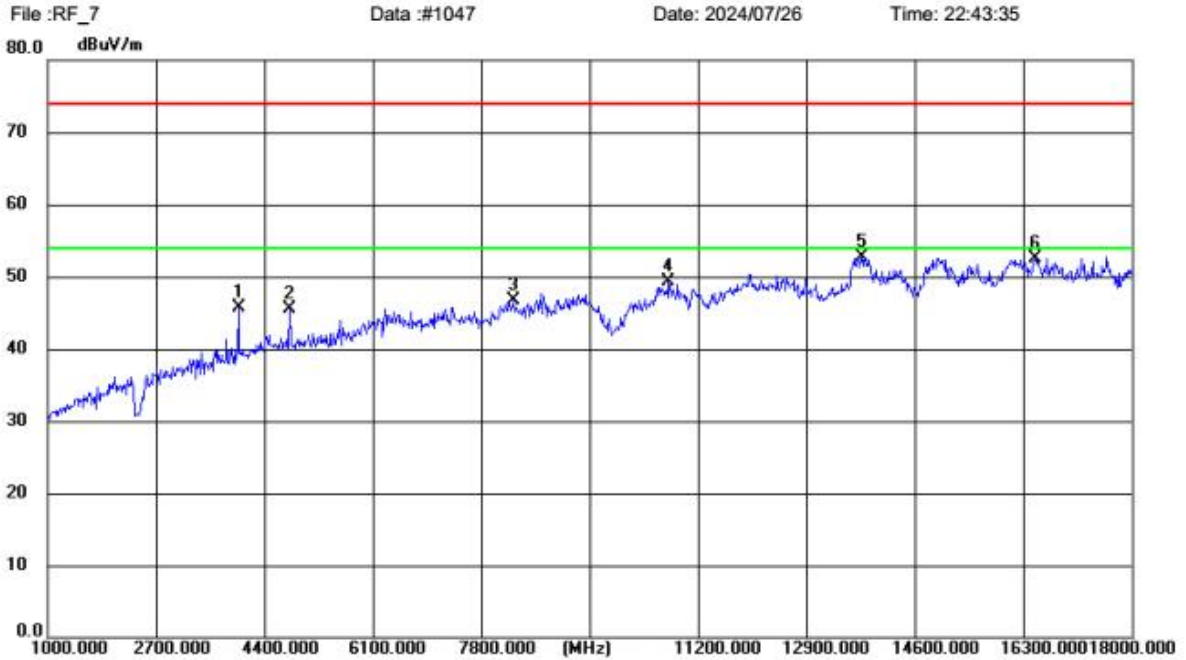

Site LAB Chamber 2 Polarization: **Horizontal** Temperature: 25(C)
 Limit: FCC Part15 RE-Class C_Above 1GHz_PK Power: Humidity: 50 %
 EUT: Distance: 3m
 M/N: ANCEL V5 BT
 Mode: BLE1M 2402MHz TX
 Note: OBDSPACE TECHNOLOGY CO.,LTD

No.	Frequency (MHz)	Reading (dBUV)	Factor (dB/m)	Level (dBUV/m)	Limit (dBUV/m)	Margin (dB)	Detector	Height (cm)	Azimuth (deg.)	P/F	Remark
1	4002.625	55.92	-10.28	45.64	74.00	28.36	peak	150	127	P	
2	4803.750	53.50	-8.09	45.41	74.00	28.59	peak	150	2	P	
3	8310.000	48.84	-2.18	46.66	74.00	27.34	peak	150	85	P	
4	10751.625	49.02	0.33	49.35	74.00	24.65	peak	150	221	P	
5	13771.250	49.00	3.79	52.79	74.00	21.21	peak	150	44	P	
6	16495.500	46.35	6.18	52.53	74.00	21.47	peak	150	337	P	

Vertical



Shenzhen CTL Testing Technology Co., Ltd
Tel: +86-755-89486194

Radiated Emission Measurement

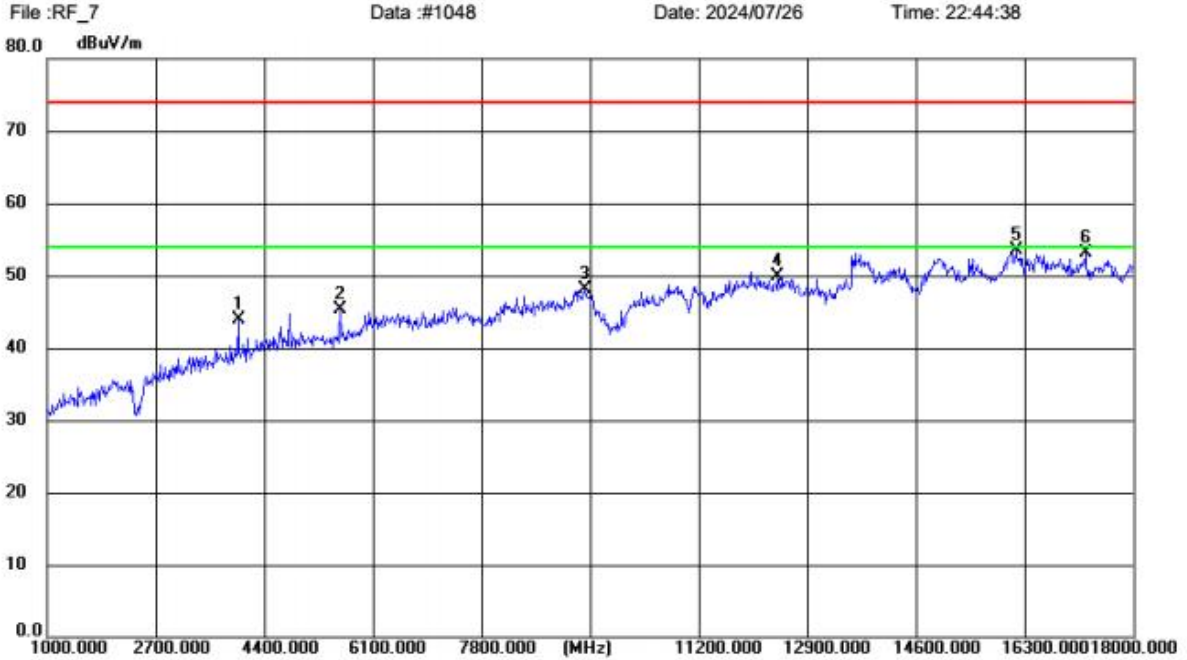

Site LAB Chamber 2 Polarization: **Vertical** Temperature: 25(C)
 Limit: FCC Part15 RE-Class C_Above 1GHz_PK Power: Humidity: 50 %
 EUT: Distance: 3m
 M/N: ANCEL V5 BT
 Mode: BLE1M 2402MHz TX
 Note: OBDSpace TECHNOLOGY CO.,LTD

No.	Frequency (MHz)	Reading (dBuV)	Factor (dB/m)	Level (dBuV/m)	Limit (dBuV/m)	Margin (dB)	Detector	Height (cm)	Azimuth (deg.)	P/F	Remark
1	4002.625	54.15	-10.28	43.87	74.00	30.13	peak	150	349	P	
2	5604.875	52.50	-7.29	45.21	74.00	28.79	peak	150	296	P	
3	9417.125	47.84	0.23	48.07	74.00	25.93	peak	150	358	P	
4	12453.750	47.74	2.25	49.99	74.00	24.01	peak	150	286	P	
5	16174.625	48.28	5.17	53.45	74.00	20.55	peak	150	87	P	
6	17266.875	45.05	7.99	53.04	74.00	20.96	peak	150	77	P	

REMARKS:

- 18GHz-26GHz not recorded for no spurious point have a margin of less than 6 dB with respect to the limits.
- PK detector measurement value is lower than the average limit. Therefore, there is no need to test AV detector measurements.

Results of Band Edges Test (Radiated)

Note: BLE 1M, BLE 2M all have been tested, only worse case BLE 2M is reported.

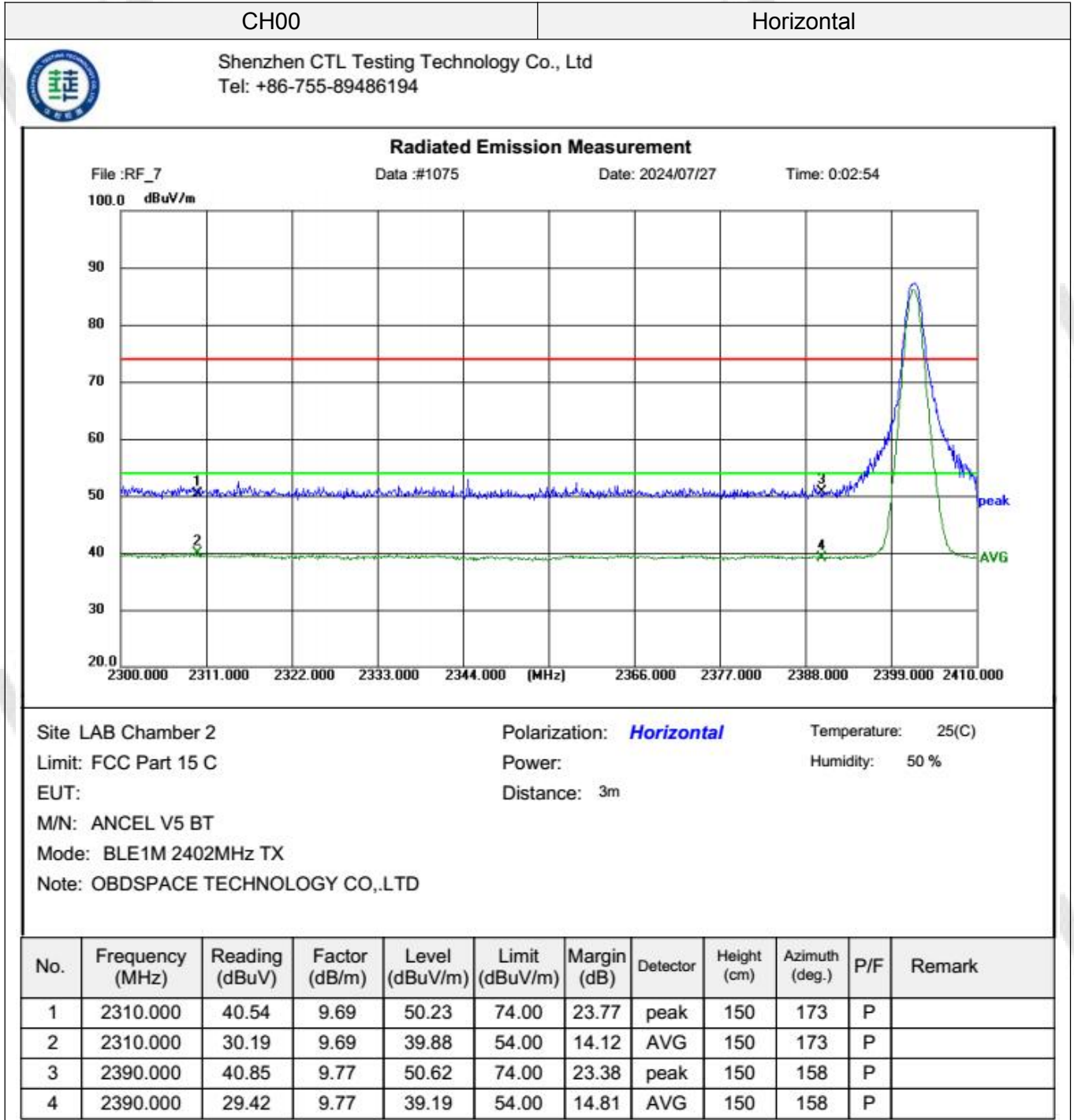

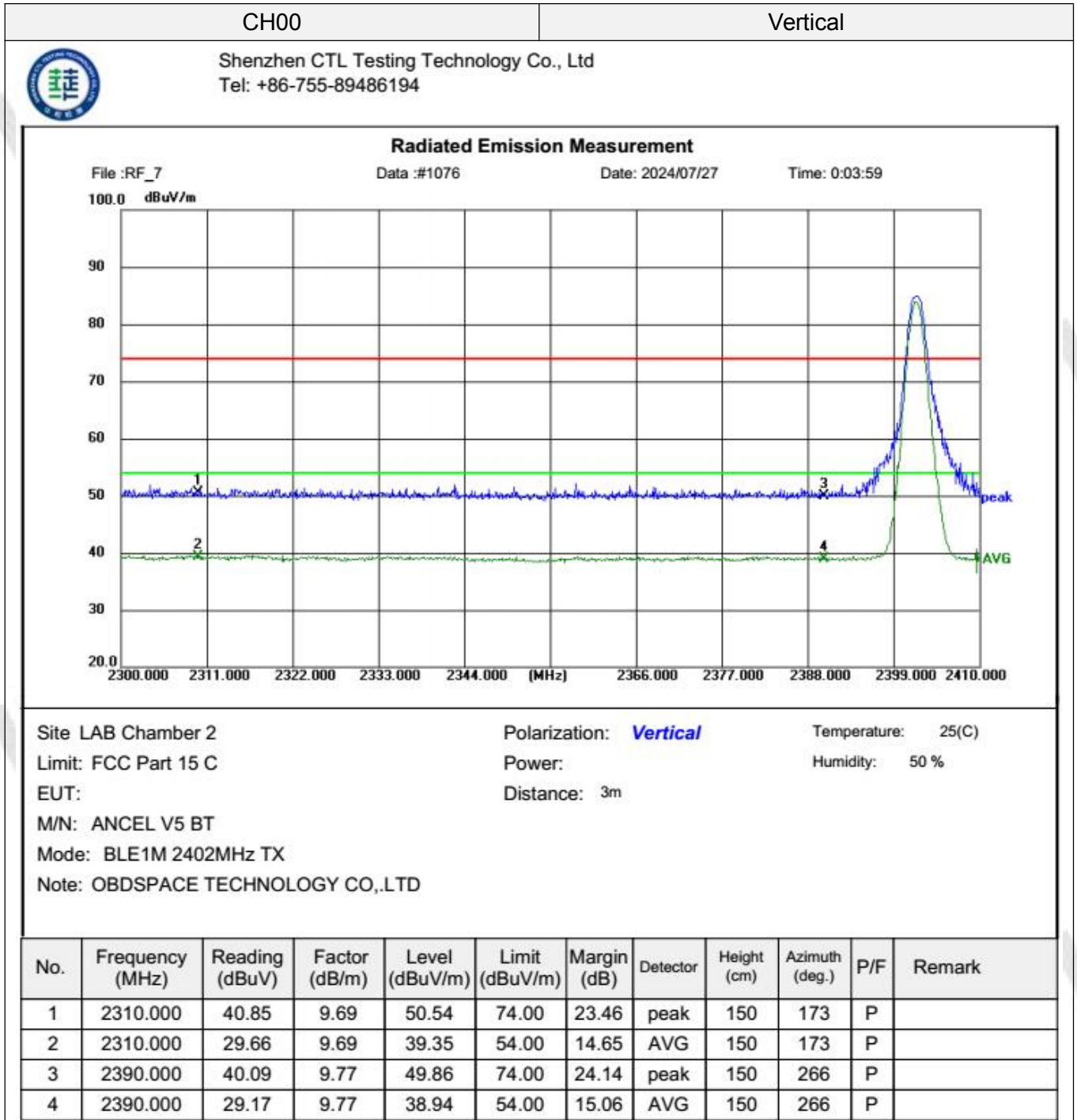

CH39

Horizontal



Shenzhen CTL Testing Technology Co., Ltd
Tel: +86-755-89486194

Radiated Emission Measurement

File :RF_7 Data :#1077 Date: 2024/07/27 Time: 0:07:10

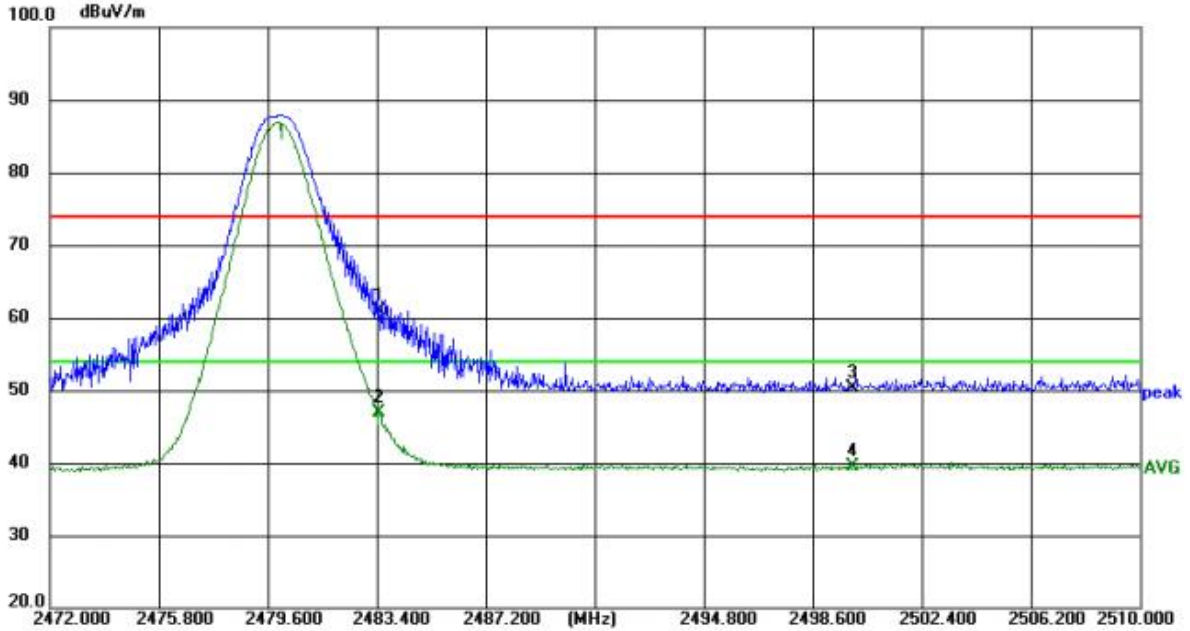

Site LAB Chamber 2	Polarization: Horizontal	Temperature: 25(C)
Limit: FCC Part 15 C	Power:	Humidity: 50 %
EUT:	Distance: 3m	
M/N: ANCEL V5 BT		
Mode: BLE1M 2480MHz TX		
Note: OBDSpace TECHNOLOGY CO.,LTD		

No.	Frequency (MHz)	Reading (dBuV)	Factor (dB/m)	Level (dBuV/m)	Limit (dBuV/m)	Margin (dB)	Detector	Height (cm)	Azimuth (deg.)	P/F	Remark
1	2483.500	50.96	9.93	60.89	74.00	13.11	peak	150	110	P	
2	2483.500	36.89	9.93	46.82	54.00	7.18	AVG	150	110	P	
3	2500.000	40.37	10.00	50.37	74.00	23.63	peak	150	126	P	
4	2500.000	29.45	10.00	39.45	54.00	14.55	AVG	150	126	P	

CH39

Vertical



Shenzhen CTL Testing Technology Co., Ltd
Tel: +86-755-89486194

Radiated Emission Measurement

File :RF_7 Data :#1078 Date: 2024/07/27 Time: 0:08:15

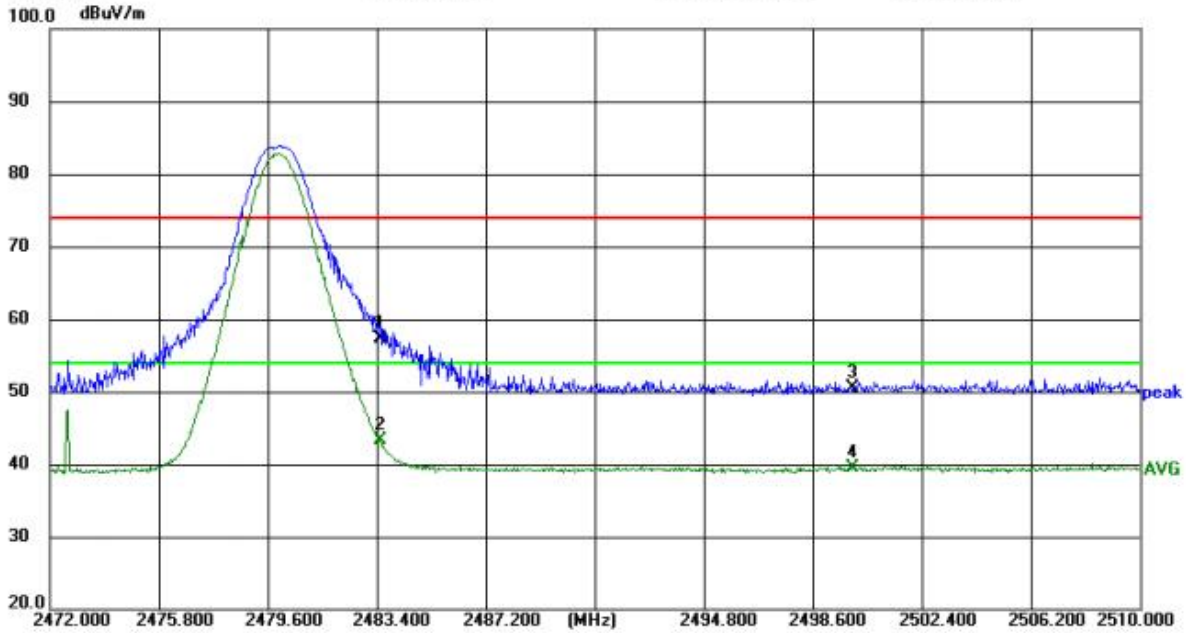

Site LAB Chamber 2 Polarization: **Vertical** Temperature: 25(C)
Limit: FCC Part 15 C Power: Humidity: 50 %
EUT: Distance: 3m
M/N: ANCEL V5 BT
Mode: BLE1M 2480MHz TX
Note: OBDSpace TECHNOLOGY CO.,LTD

No.	Frequency (MHz)	Reading (dBuV)	Factor (dB/m)	Level (dBuV/m)	Limit (dBuV/m)	Margin (dB)	Detector	Height (cm)	Azimuth (deg.)	P/F	Remark
1	2483.500	47.46	9.93	57.39	74.00	16.61	peak	150	234	P	
2	2483.500	33.41	9.93	43.34	54.00	10.66	AVG	150	234	P	
3	2500.000	40.56	10.00	50.56	74.00	23.44	peak	150	250	P	
4	2500.000	29.52	10.00	39.52	54.00	14.48	AVG	150	250	P	

3.3. Maximum Conducted Output Power

Limit

The Maximum Peak Output Power Measurement is 30dBm.

Test Procedure

Remove the antenna from the EUT and then connect a low loss RF cable from the antenna port to the Spectrum Analyzer.

Test Configuration

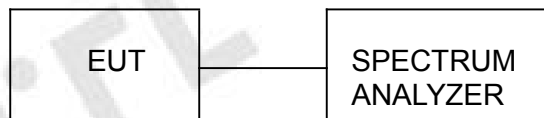

Test Results

Raw data reference to Section 2 of document No. CTL2404222131-WF02_BLE_Appendix.

3.4. Power Spectral Density

Limit

For digitally modulated systems, the power spectral density conducted from the intentional radiator to the antenna shall not be greater than 8 dBm in any 3 kHz band during any time interval of continuous transmission.

Test Procedure

1. Use this procedure when the maximum peak conducted output power in the fundamental emission is used to demonstrate compliance.
2. Set the RBW \geq 3 kHz.
3. Set the VBW \geq 3 \times RBW.
4. Set the span to 1.5 times the DTS channel bandwidth.
5. Detector = peak.
6. Sweep time = auto couple.
7. Trace mode = max hold.
8. Allow trace to fully stabilize.
9. Use the peak marker function to determine the maximum power level.
10. If measured value exceeds limit, reduce RBW (no less than 3 kHz) and repeat.
11. The resulting peak PSD level must be 8dBm.

Test Configuration



Test Results

Raw data reference to Section 3 of document No. CTL2404222131-WF02_BLE_Appendix.

3.5. 6dB Bandwidth

Limit

For digital modulation systems, the minimum 6 dB bandwidth shall be at least 500 kHz

Test Procedure

The transmitter output was connected to the spectrum analyzer through an attenuator. The bandwidth of the fundamental frequency was measured by spectrum analyzer with 100 KHz RBW and 300 KHz VBW. The 6dB bandwidth is defined as the total spectrum the power of which is higher than peak power minus 6dB.

Test Configuration



Test Results

Raw data reference to Section 1 of document No. CTL2404222131-WF02_BLE_Appendix.

3.6. Out-of-band Emissions

Limit

In any 100 kHz bandwidth outside the frequency band in which the spread spectrum or digitally modulated intentional radiator is operating, the radio frequency power that is produced by the intentional radiator shall be at least 20 dB below that in the 100 kHz bandwidth within the band that contains the highest level of the desired power, based on either an RF conducted or a radiated measurement, provided the transmitter demonstrates compliance with the peak conducted power limits. If the transmitter complies with the conducted power limits based on the use of RMS averaging over a time interval, as permitted under paragraph (b)(3) of this section, the attenuation required under this paragraph shall be 30 dB instead of 20 dB. Attenuation below the general limits specified in §15.209(a) is not required.

Test Procedure

Connect the transmitter output to spectrum analyzer using a low loss RF cable, and set the spectrum analyzer to RBW=100 kHz, VBW= 300 kHz, peak detector, and max hold. Measurements utilizing these settings are made of the in-band reference level, bandedge and out-of-band emissions.

Test Configuration



Test Results

Raw data reference to Section 4 of document No. CTL2404222131-WF02_BLE_Appendix.

3.7. Antenna Requirement

Standard Applicable

For intentional device, according to FCC 47 CFR Section 15.203:

An intentional radiator shall be designed to ensure that no antenna other than that furnished by the responsible party shall be used with the device. The use of a permanently attached antenna or of an antenna that uses a unique coupling to the intentional radiator, the manufacturer may design the unit so that a broken antenna can be replaced by the user, but the use of a standard antenna jack or electrical connector is prohibited

FCC CFR Title 47 Part 15 Subpart C Section 15.247(b) (4):

(4) The conducted output power limit specified in paragraph (b) of this section is based on the use of antennas with directional gains that do not exceed 6 dBi. Except as shown in paragraph (c) of this section, if transmitting antennas of directional gain greater than 6 dBi are used, the conducted output power from the intentional radiator shall be reduced below the stated values in paragraphs (b)(1), (b)(2), and (b)(3) of this section, as appropriate, by the amount in dB that the directional gain of the antenna exceeds 6 dBi.

Test Result:

The maximum gain of antenna was 0dBi

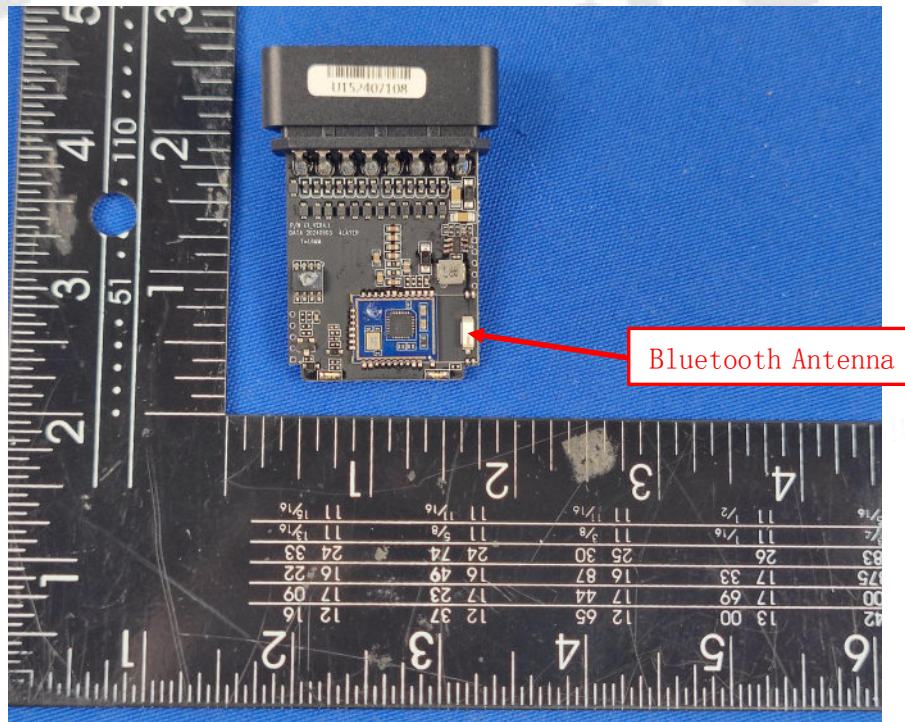

4. Test Setup Photos of the EUT

Reference to the test report No. CTL2404222131-WF01

5. Photos of the EUT

Reference to the test report No. CTL2404222131-WF01

***** End of Report *****