



User's Manual

www.anceltech.com

Table of Contents

1. Statement	1
1.1 Agreement	1
1.2 Copyright information	1
1.3 Disclaimer	2
1.4 Safety Information	2
1.4.1 Inspection Precautions	3
2. Product Description.....	6
2.1 Product Overview	6
2.2 Tablet parameter	6
2.3 V5 Tablet interface instruction	8
2.4 V5 BT Tablet interface instruction	9
2.5 V5 BT VCI instruction	10
2.6 V5 BT VCI Parameter.....	11
3. Software Introduction.....	12
3.1 Diagnosis.....	13
3.2 Hot function.....	16
3.3 Quick Support	17
3.4 DTC Query.....	18
3.5 Update	18
3.6 Data Manager	20
3.7 Feedback.....	21
3.8 Settings	24
4. Product Activation.....	27
5.1 Cleaning and maintenance	30
5.2 Warranty.....	31

1. Statement

You must carefully read the instruction manual, especially the safety instructions, before you can connect, commission and operate the products of OBDSpace Technology Co., Ltd., Ltd. (hereinafter referred to as "OBDSpace").

1.1 Agreement

Once the product is used, it is an endorsement of the following:

(1) Please refer to the packing list of the random distribution for the configuration equipment of this product, whichever is the actual product;

(2) The functions and pictures described in this manual are subject to the actual software. All information, specifications and illustrations in the manual are the latest information at the time of publication. The company reserves the right to change it without notice.

1.2 Copyright information

It cannot be copied or stored in any form (electronic, mechanical, photocopying, recording or otherwise) without prior written permission being secured from OBDSpace. Software and data are owned by technology and protected by copyright laws, international

contract law, and other national laws. It is strictly forbidden to copy or transfer the data and software or some of the contents. If there is any violation, the technology will be held legally responsible according to law.

1.3 Disclaimer

(1) This manual only provides the operation and operation methods for Ancel V5 & V5 BT. The company does not assume any responsibility for the consequences caused by using the operation methods for other equipment operations.

(2) The company shall not accept any responsibility for accidents caused either by the user personally or anyone else, or costs and expenses due to equipment damages including equipment loss caused by the user's abuse or misuse, arbitrary changes or repairs or operation of the equipment in a manner not in accordance with the manual requirements.

1.4 Safety Information

For the safety of yourself and others, and to avoid damage to equipment and vehicles, all personnel handling the equipment must read the safety precautions mentioned in the manual.

1.4.1 Inspection Precautions

(1) Ancel V5 & V5 BT can only be connected to a safety outlet that is grounded. Before connecting, check and confirm that the diagnostic circuit is in good condition. Otherwise, it is not necessary to test to avoid damage to the main unit. If necessary, use a multimeter to measure the diagnostic seat voltage.

(2) Use only the power cord supplied with the OBDSpace diagnostics or detected power line.

(3) Pay special attention to the effects or damage caused by environmental factors such as acid and alkali, poison gas, and heavy pressure.

(4) Exhaust gases from the engine contain a variety of toxic compounds and should be avoided. Park the vehicle in a well ventilated area before operation.

(5) Do not place the device on the vehicle's power distribution unit. Strong electromagnetic interference can cause damage to the equipment.

(6) After the equipment is installed successfully, before starting the engine, make sure that the parking brake is pulled and the speed lever is placed in the neutral or parked position to avoid accidents when the vehicle is started.

(7) When the engine is running at a high temperature, avoid contact

with high temperature components such as the water tank and the exhaust pipe. At the same time, be careful of the voltage generated by the components such as the ignition coil, the distributor cover, the ignition circuit and the ignition plug during engine operation.

1.4.2 Notes on the use of the instrument

(1) This instrument is a precision electronic instrument. Do not drop it. Handle it as gently as possible, away from heat and electromagnetic fields.

(2) Ensure that the instrument and diagnostics are well connected so that signal interruptions do not affect the test.

(3) Use screws as much as possible when using the cables and connectors to avoid disconnecting and damaging the connectors when moving. Hold the front end of the connector when pulling the connector, and avoid pulling the rear cable to avoid damage to the diagnostic interface.

(4) When the electrical components are energized, the circuit cannot be disconnected to prevent self-inductance, mutual inductance and current sensors and the vehicle ECU.

(5) The operation of this instrument requires a certain basis for vehicle inspection and maintenance, and has a certain understanding of the electronic control system of the vehicle under test.

1.4.3 Operating car ECU considerations

When performing diagnostic operations on a vehicle equipped with

a computer control system, the following should be noted:

(1) Do not place magnetic objects such as radio speakers close to the computer, as the magnetic properties of the speakers can damage the circuits and components in the ECU.

(2) When the ignition switch is turned on, the internal electrical equipment of the car must not be disconnected. Due to the self-inductance of the coil when disconnected, a high instantaneous voltage will be generated, which will cause damage to the sensor and ECU;

(3) When performing repairs near a computer or sensor, special care should be taken to avoid damage to the ECU and sensor;

(4) When carrying out maintenance work on or near the ECU-controlled digital meter, be sure to wear a metal strap with one end clamped to the body and the other end wrapped around the wrist;

(5) When performing welding work on a car, the ECU system power should be turned off beforehand;

(6) Do not use test lights to test ECU-related electrical devices to prevent damage to the ECU or sensor unless specifically stated;

(7) Test ECU and sensors cannot be tested with a pointer-type ohmmeter, unless otherwise specified in the test procedure, but should be tested with a high-impedance digital meter.

2. Product Description

2.1 Product Overview

Ancel V5 & V5 BT is an Android based brand new-generation overall diagnostic tool for heavy duty trucks and commercial vehicles and machineries. With 7 -inch high-qualified industrial diagnostic tablet, in which software covering more trucks, buses, machineries from home and abroad with extensive diagnostic functions. Featuring new diagnostic experience and cost performance, it can be a better choice for all users.

2.2 Tablet parameter

Item	Description
Display screen	7"G+G capacitance screen,1024*600
System	Android 10.0,multi language
CPU	A133 ARM Cortex-A53,Quad Core at 1.5 Ghz
GPU	IMG PowerVR GE8300
ROM	32 GB EMMC
RAM	2G LPDDR4
Battery	Polymer lithiumion battery;3.7V/5000 mA,Battery life:5H
Speaker	Double speakers 8Ω/1W
Interface	Type-C,TF card slot(support SDHC/SDXC)

Network	WIFI 802.11b/g/n
Bluetooth	Bluetooth 2.1/4.0
Input voltage	5V/2A
Working temperature	-10 to 70°C (14-158°F),relative humidity:<90%
Storage temperature	-30 to 120°C (-22 to 248°F),relative humidity:<90%
Dimensions(WxHxD)	270 mm(10.63 in) x 193 mm(7.60 in) x 38 mm(1.50 in)
Weight	NW: 1.20 kg (2.65 lb) GW: 3.00 kg (6.61 lb)
Protocols	ISO 9141-2, ISO 14230-2, ISO 15765-4, K/L-Line, SAE-J1850 VPW, SAE-J1850 PWM, CAN ISO 11898, Highspeed, Middlespeed, Lowspeed and Singlespeed CAN, GM UART, UART Echo Byte Protocol, Honda Diag-H Protocol, TP2.0, TP1.6, SAE J1939, SAE J1708, Fault-Tolerant CAN etc.

2.3 V5 Tablet interface instruction

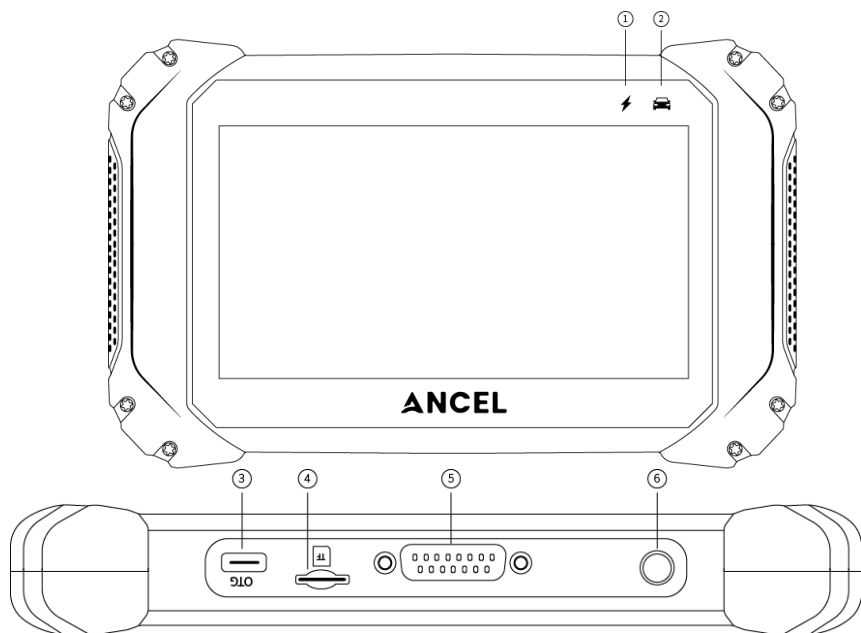

No.	Name	Description
①	Charging Indicator	Light on blue when the tablet charge Light off when fully charged
②	Communication Indicator	The light flashing when diagnose communication
③	OTG Port	Type-C Port, for battery charging
④	TF Port	TF card port, Up to 32GB expand
⑤	OBD Port	OBDII main cable connector

⑥	Start Button	The button turn ON/OFF the tablet
---	--------------	-----------------------------------

2.4 V5 BT Tablet interface instruction

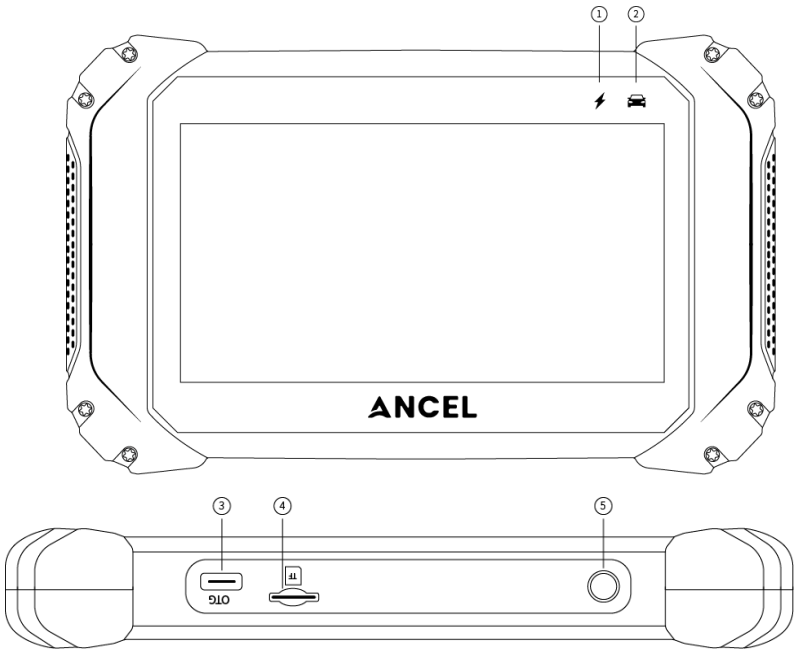

No.	Name	Description
①	Charging Indicator	Light on blue when the tablet charge Light off when fully charged
②	Communication	The light flashing when diagnose

	Indicator	communication
③	OTG Port	Type-C Port, for battery charging
④	TF Port	TF card port, Up to 32GB expand
⑤	Start Button	The button turn ON/OFF the tablet

2.5 V5 BT VCI instruction

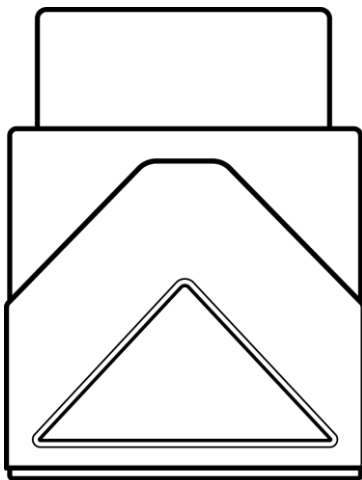

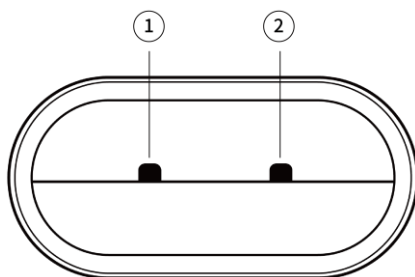

No.	Name	Description
①	Power and Bluetooth connection Indicator	Light on red & blue flashing: Power on and Bluetooth is disconnected Light on blue: Bluetooth is connected Light on blue flashing: communicating
②	Vehicle communication indicator	Flashing When communicating

2.6 V5 BT VCI Parameter

Processor	ARM 32-bit Cortex processor
Input Voltage	DC 8-18V
Operating Temperature	-10 to 70°C (14-158°F) , relative Humidity:<90%
Storage Temperature	-30 to 120°C (-22-248°F) , relative Humidity:<90%

Communication model	Bluetooth
Protocols	ISO 9141, ISO14230, ISO15765, ISO11898, SAE-J1850 VPW, SAE-1850 PWM, J1939, J1708, UDS, K/L lines, High speed CAN, Middle speed CAN, Low speed CAN and Single wire CAN

3. Software Introduction

Ancel software client homepage:

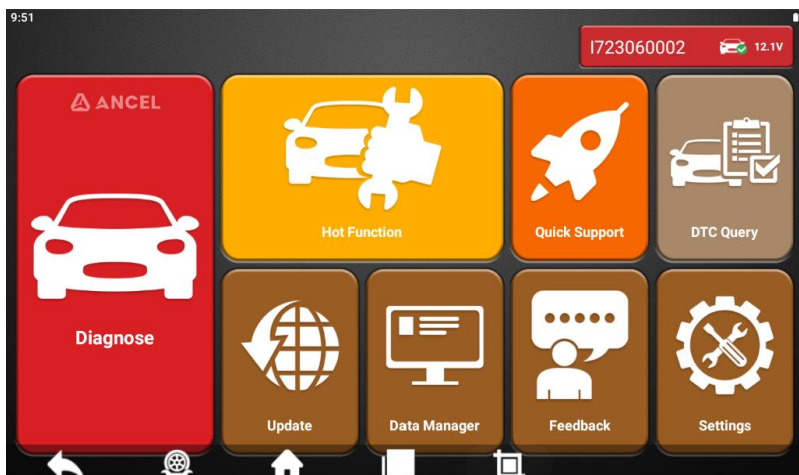





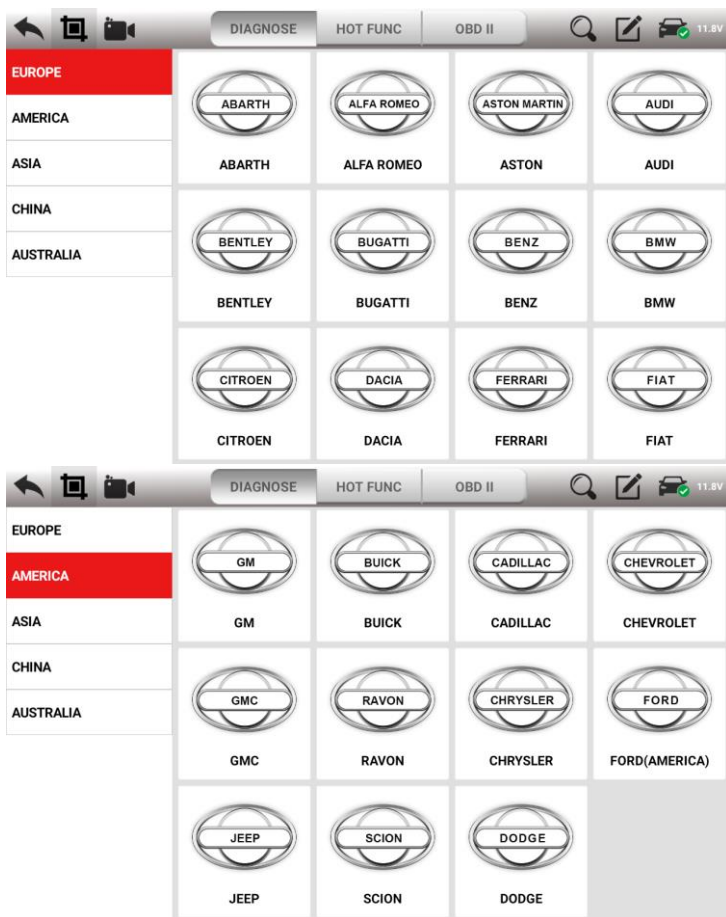







3.1 Diagnosis











Extensive vehicle coverage for more than 80 Europe, America, Asia, China and Australia vehicle makes.



DIAGNOSE HOT FUNC OBD II 11.8V

EUROPE				
AMERICA	HYUNDAI	ACURA	DAEWOO	DAIHATSU
ASIA	HYUNDAI	ACURA	DAEWOO	DAIHATSU
CHINA				
AUSTRALIA	FUSO	HONDA	INFINITI	ISUZU
				
	KIA	LEXUS	LUXGEN	MAZDA

DIAGNOSE HOT FUNC OBD II 11.8V

EUROPE				
AMERICA	BYD	CHANGAN	CHANGHE	CHERY
ASIA	BYD	CHANGAN	CHANGHE	CHERY
CHINA				
AUSTRALIA	EMGRAND	ENGLON	FOTON	GEELY
				
	GLEAGLE	GWM	HBSH	HUACHEN

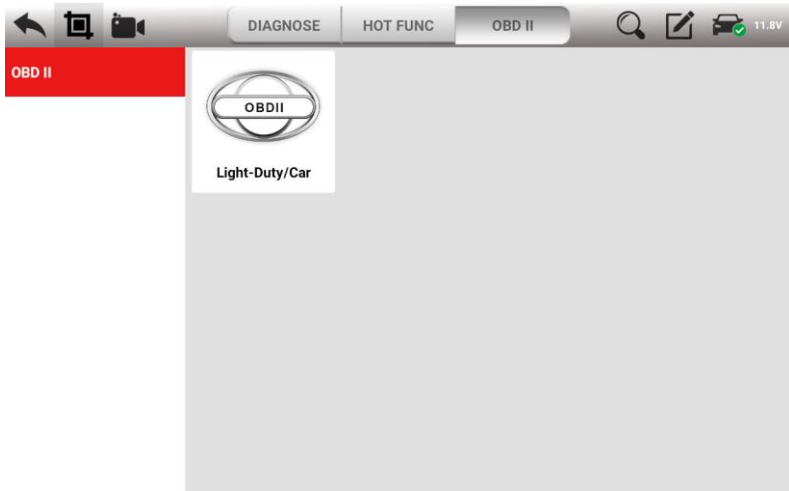
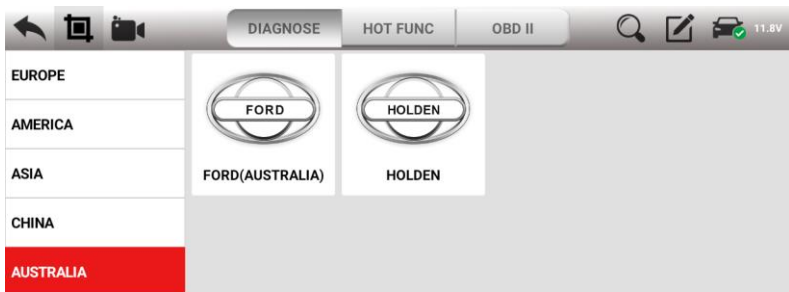

3.2 Hot function

Supporting 10 most commonly used service Reset Functions: OILREST, ABS BLEEDING, BATTERY, DPF, EPB, INJECTOR, SAS, THROTTLE, TPMS, AT SET.

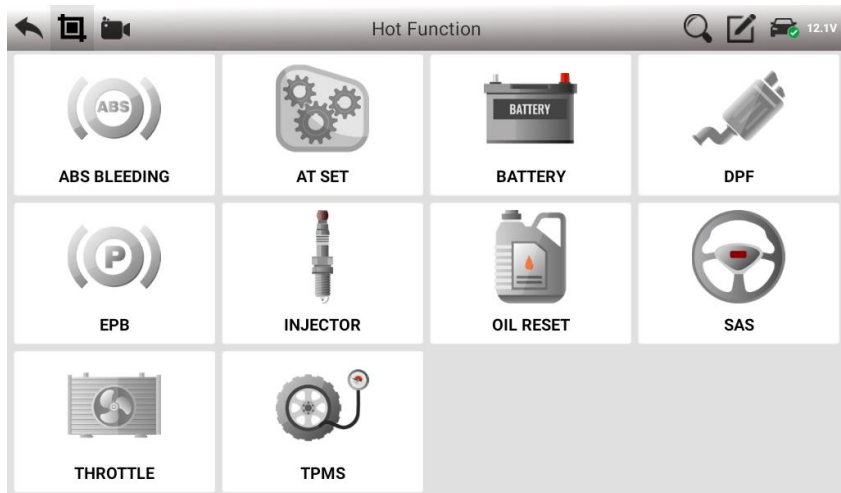

3.3 Quick Support

The function allows OBDSpace technical staff to connect to your host through the network remotely to help you diagnose the vehicle.

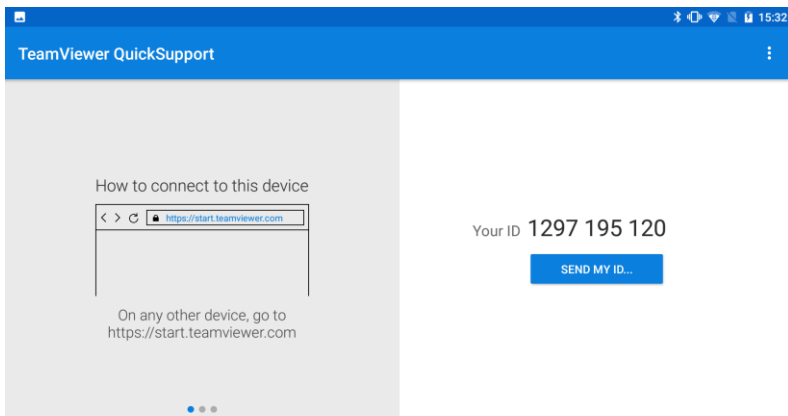

● Ready to connect (secure connection)

3.4 DTC Query

The fault information corresponding to the fault code can be quickly retrieved to help the repairer locate the component fault.

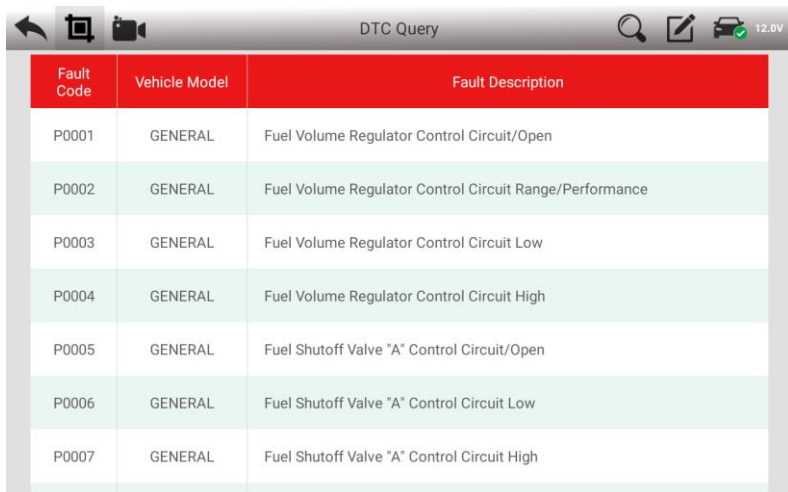

Fault Code	Vehicle Model	Fault Description
P0001	GENERAL	Fuel Volume Regulator Control Circuit/Open
P0002	GENERAL	Fuel Volume Regulator Control Circuit Range/Performance
P0003	GENERAL	Fuel Volume Regulator Control Circuit Low
P0004	GENERAL	Fuel Volume Regulator Control Circuit High
P0005	GENERAL	Fuel Shutoff Valve "A" Control Circuit/Open
P0006	GENERAL	Fuel Shutoff Valve "A" Control Circuit Low
P0007	GENERAL	Fuel Shutoff Valve "A" Control Circuit High

3.5 Update











- Connect the internet by WIFI.
- Login (input the serial number and password at the first time).
- Select the software and click the download button.

1723060002 

..... 

LOGIN

[Forgot password](#)

 Common Data V3.4	 CHRYSLER V25.2 95.27MB <input checked="" type="checkbox"/>
 FIAT V16.0 20.28MB <input checked="" type="checkbox"/>	 GM V14.75 80.5MB <input checked="" type="checkbox"/>
 HYUNDAI V25.5 65.76MB <input checked="" type="checkbox"/>	 MAZDA V18.01 30.88MB <input checked="" type="checkbox"/>
 OPEL V13.64 24.66MB <input checked="" type="checkbox"/>	 PORSCHE V20.2 81.42MB <input checked="" type="checkbox"/>
 ASTON V12.0	 BENZ V17.50 <input checked="" type="checkbox"/>



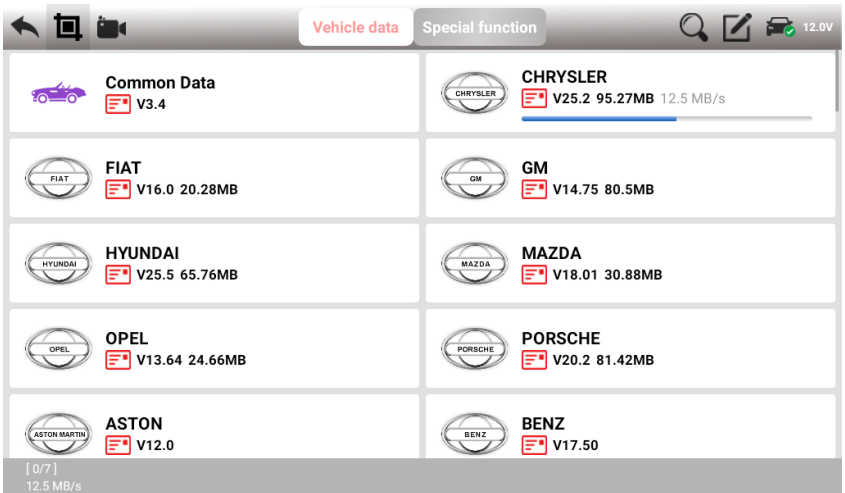

3.6 Data Manager

The storage location of vehicle applications, test pictures, videos, reports and for user reference.

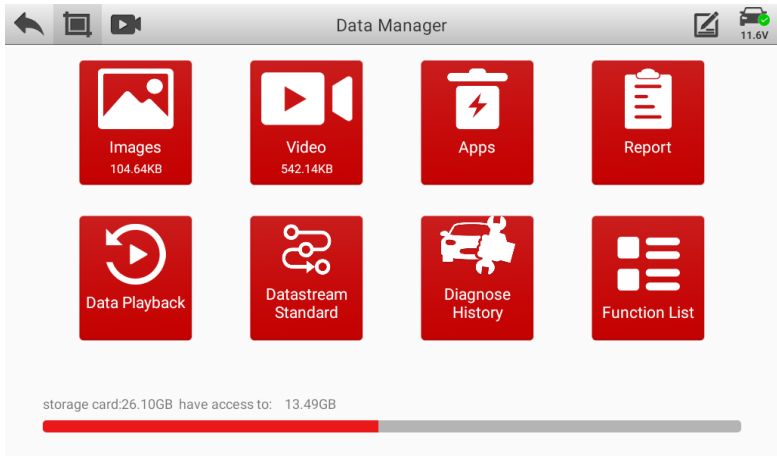

3.7 Feedback

This function allows you upload vehicle diagnostics problems encountered by users during the use of the software. It can help engineers repair software errors quickly.

First, select the problem type:

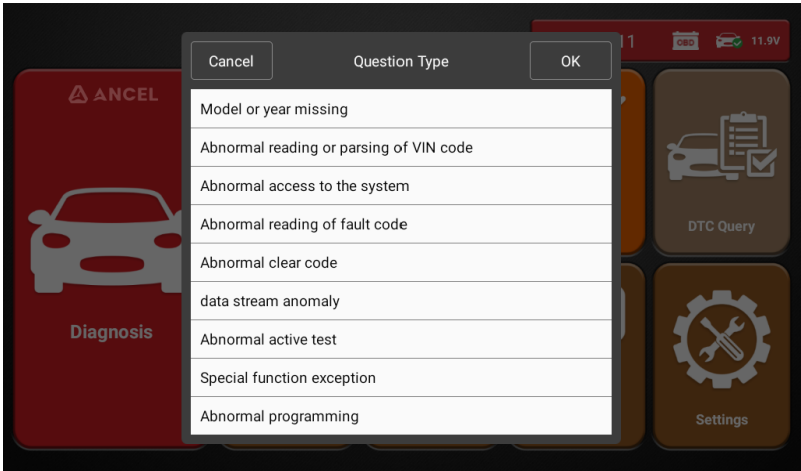

Second, select the vehicle brand:

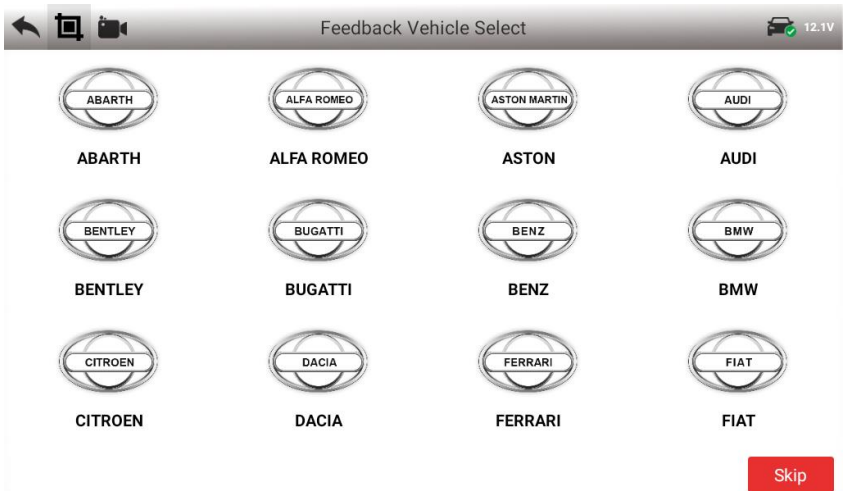

Third, input the problem information, and then click “Submit”.

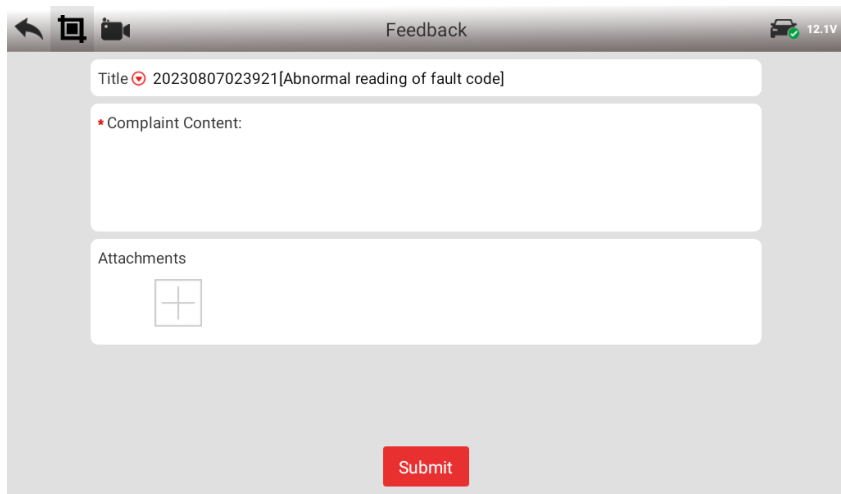

The screenshot shows a mobile application interface for submitting feedback. At the top, there is a navigation bar with a back arrow, a camera icon, and a microphone icon on the left, and the word "Feedback" in the center. On the right side of the bar, there is a car icon with a green checkmark and the text "12.1V". Below the navigation bar, there are three main input areas: 1. A "Title" field containing the text "20230807023921[Abnormal reading of fault code]". 2. A "Complaint Content" field, indicated by a red asterisk, which is currently empty. 3. An "Attachments" field containing a square icon with a plus sign inside, used for adding files. At the bottom center of the screen, there is a prominent red button labeled "Submit".

3.8 Settings

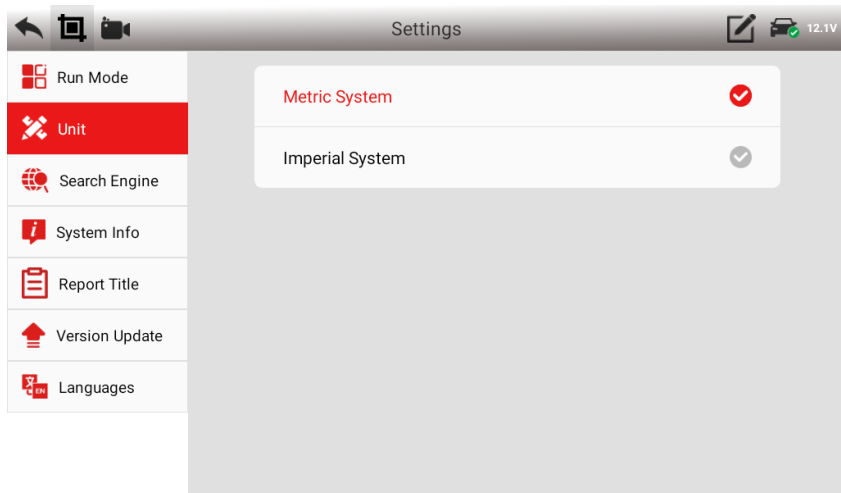
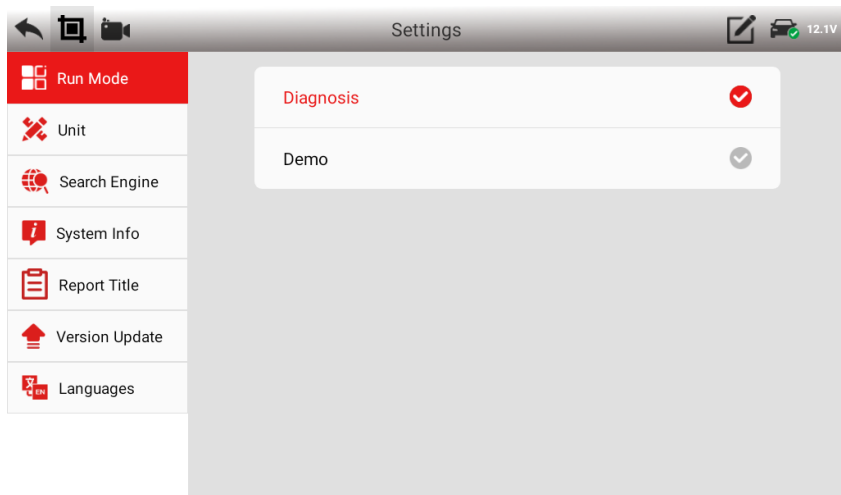

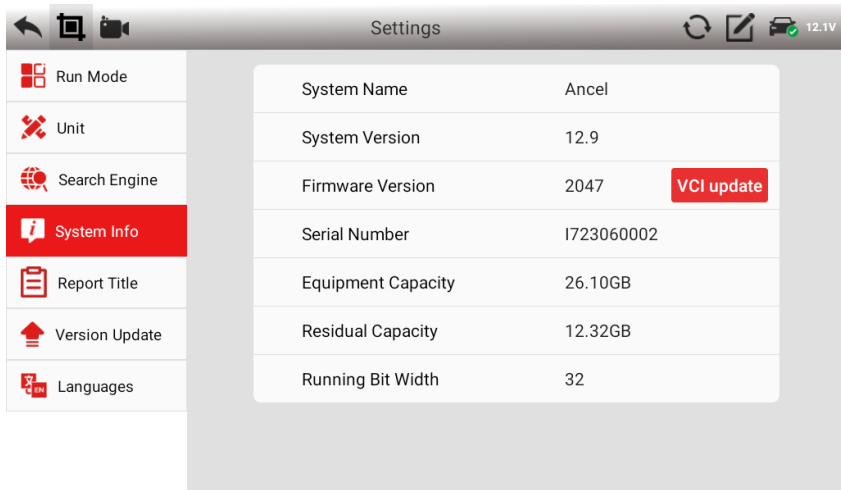
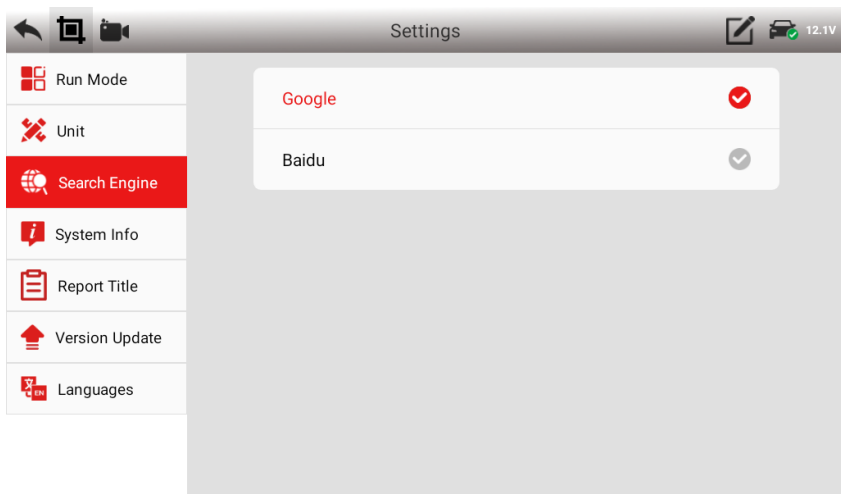

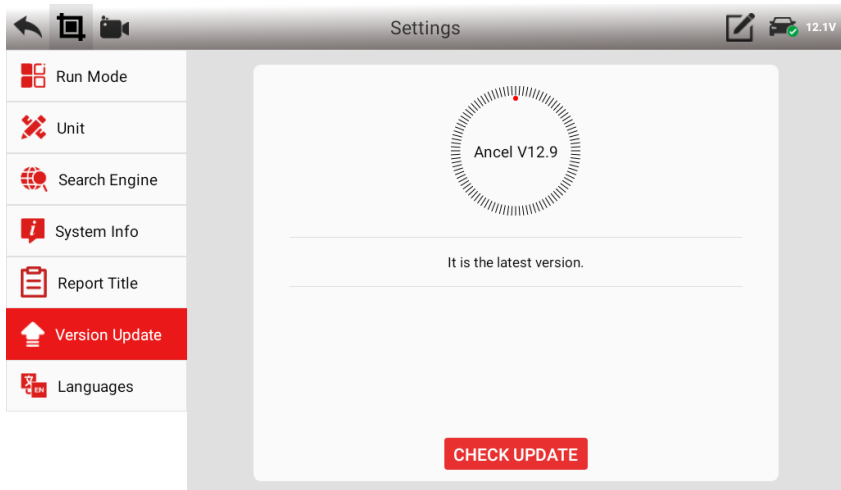
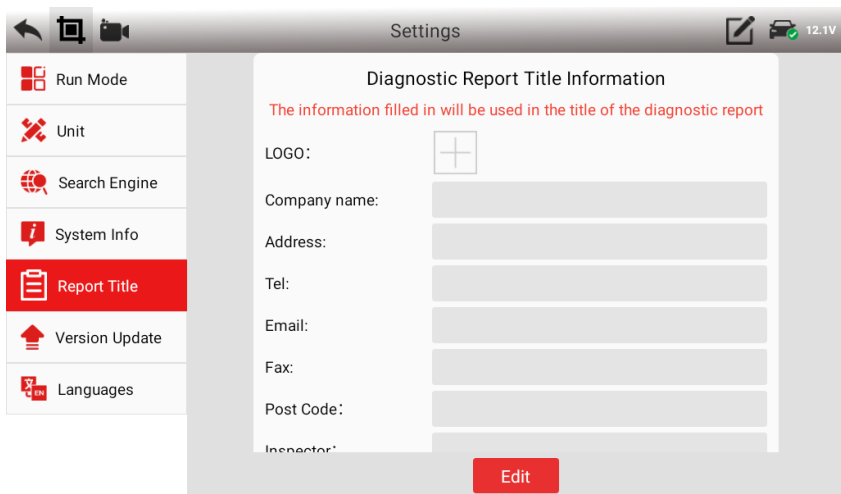

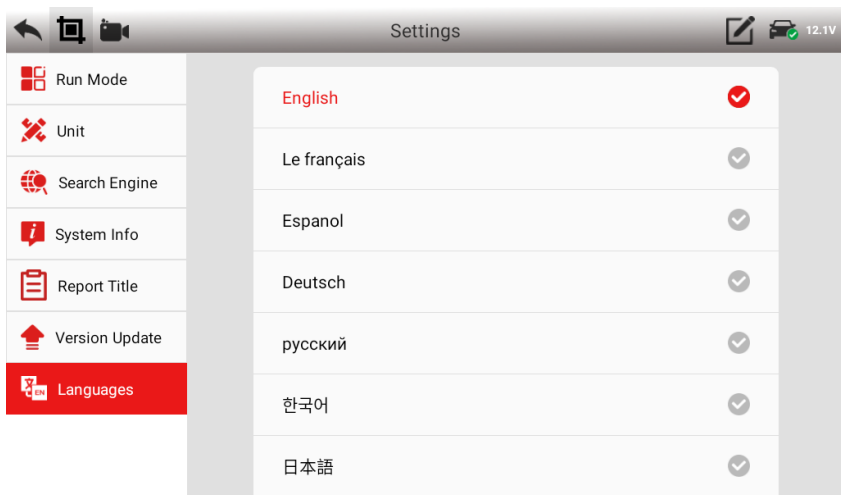

4. Product Activation

(1) Enter the **【Update】** function, input the serial number and the password (you can find the password in the password envelope).

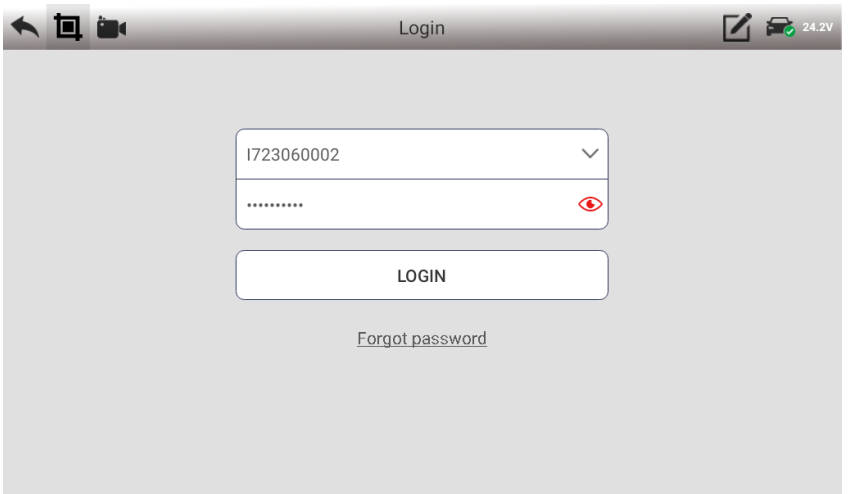

(3) Click **【Login】** , and a prompt box will pop up.

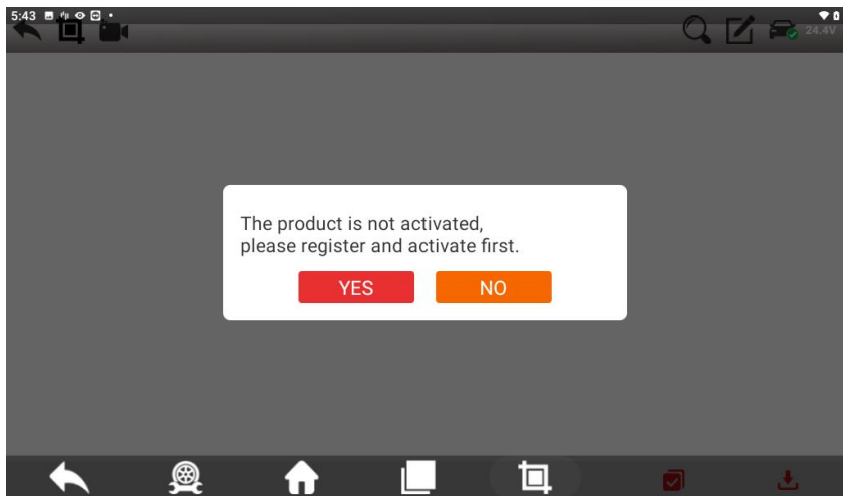

(4) Click **【Yes】** to fill in the activation information.

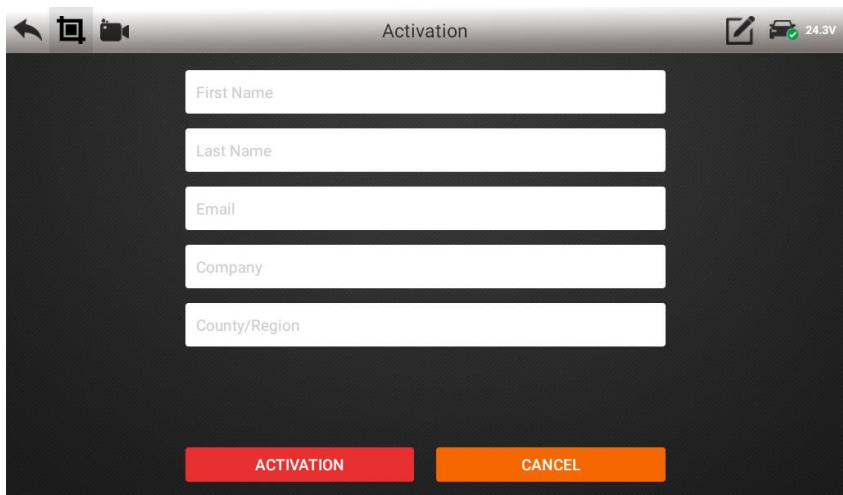

(5) After the information is filled out, click **【ACTIVATION】** .

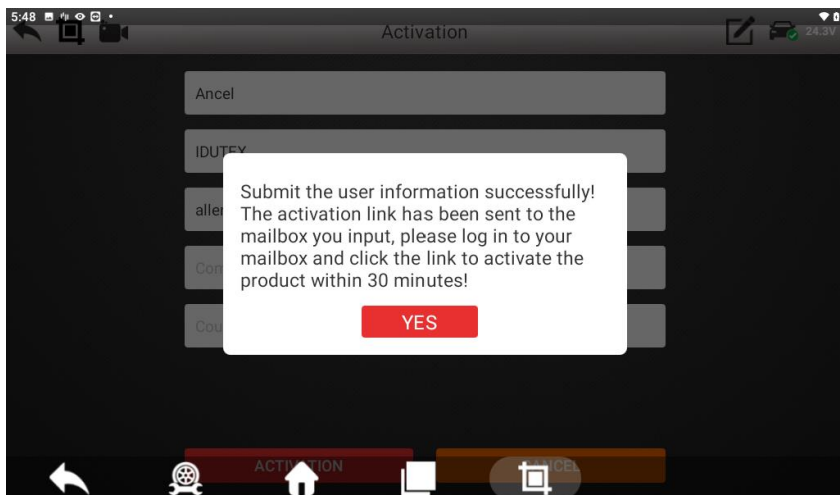

(6) Click **【Yes】** , complete the product activation.

5. Cleaning and maintenance and warranty

5.1 Cleaning and maintenance

(1) Do not disassemble it, try to handle it gently to avoid impact.

(2) Place the fault diagnosis device in a flat, dry, temperature-friendly and dust-free place and avoid high

temperature and humidity, excessive smoke, easy vibration, direct sunlight, and strong magnetic field storage environment.

(3) If the vehicle test operation is not performed for a long time, please run the main machine regularly to avoid moisture.

(4) Unplug the power plug when not in use to avoid aging of electrical components caused by long-term power.

(5) When the host is dirty, please disconnect the power before cleaning.

(6) Do not use a cleaning agent with a corrosive function or any rough cloth to clean the main unit. Only use a soft cloth and a neutral detergent.

(7) The surface of the screen can be cleaned with a special wiper for the LCD screen.

(8) Do not place anything on the screen to avoid cracking of the screen or damage to internal components.

5.2 Warranty

This applies only to products purchased from a product dealer that has been authorized by OBDSPACE. If products are purchased from anyone other than a OBDSPACE authorized product dealer, buyers will be solely responsible for the cost of product maintenance services and will not be eligible to obtain any warranty

from OBDSPACE .

(1) Product acceptance

When you receive the product, please be sure to open the package check.

Please carefully check the product category and quantity according to the attached list. If there are any shortages, errors, damages and other unpredictable abnormal conditions, please keep all the documents of the product and notify us immediately. Otherwise it is considered a waiver of the claim.

(2) Product warranty

Beginning on the date of purchase(subject to valid purchase proof and effective warranty card of the product), if the product suffers performance failure within one month which is not caused by deviation from the recommended operation or by uncontrollable environmental events, you can choose to have evaluation via our maintenance service or replacement of the product with the same model. After that, there is one year warranty service for the main unit, connectors and power adapter.

(3) Product Software Update

Two-year free software update since activation of product, and will be charged annually after free update session.

(4) Not in the scope of the free warranty

A. Failures, defects or flaws not directly related to the quality of the OBDSpace products, including but not limited to failing to use the product according to the user manual's instructions, crash, fall, disassemble by anyone other than a OBDSpace approved service person, connecting improper accessories, damage owing to impact because of improper transport or storage of the product, etc.

B. Natural wear and tear of the product: including but not limited to cover, keypad, touch screen, accessories, etc.

C. Main unit serial number and warranty card serial number discrepancy, product quality inspection tag or bar code removed, altered or damaged.

D. Maintenance and modification without the approval of OBDSpace or its distributors.

(5) Product warranty program

When the product needs to be repaired, please send the product to the local distributor or OBDSpace, and attach the purchase certificate and warranty card, fill in the following information: company name, contact name, phone number, problem description, purchase invoice.

Note: The valid purchase certificate is an important warranty service certificate. To protect your legal rights, you must obtain a formal invoice from the dealer when purchasing the machine. The

name, model number, serial number and purchase date of the product should be clearly stated on the invoice. It is covered with the official seal of the dealer.

(6) Over-warranty product maintenance regulations

If the product needs to be repaired by our company after the maintenance period, we will charge the maintenance fee appropriately, and the freight will be borne by the user.

For products that have passed the warranty period, our technical support personnel will fax the maintenance cost to the user, and will repair it after confirmation by the customer. After confirming, the customer will pay the repair fee to the designated account of our company. After the maintenance fee is received, our company will Can be repaired.



OBDSpace TECHNOLOGY CO.,LTD

D03, Block A, No.973 Minzhi Ave, Longhua District.

Shenzhen, Guangdong, China

Email: support@anceltech.com

Web: www.anceltech.com

Federal Communications Commission (FCC) Statement.

This device complies with part 15 of the FCC Rules. Operation is subject to the following two conditions:

- (1) This device may not cause harmful interference, and
- (2) this device must accept any interference received, including interference that may cause undesired operation.

Note: This equipment has been tested and found to comply with the limits for a Class B digital device, pursuant to part 15 of the FCC Rules. These limits are designed to provide Reasonable protection against harmful interference in a residential installation. This equipment generates, uses and can radiate radio frequency energy and, if not installed and used in accordance with the instructions, may cause harmful interference to radio communications. However, there is no guarantee that interference will not occur in a particular installation. If this equipment does cause harmful interference to radio or television reception, which can be determined by turning the equipment off and on, the user is encouraged to try to correct the interference by one or more of the following measures:

- Reorient or relocate the receiving antenna.
- Increase the separation between the equipment and receiver.
- Connect the equipment into an outlet on a circuit different from that to which the receiver is connected.
- Consult the dealer or an experienced radio/TV technician for help.

Warning: Changes or modifications made to this device not expressly approved by **OBDSpace Technology Co., LTD** may void the FCC authorization to operate this device.

Note: The manufacturer is not responsible for any radio or TV interference caused by unauthorized modifications to this equipment. Such modifications could void the user's authority to operate the equipment.

RF exposure statement:

This device complies with FCC RF radiation exposure limits set forth for an uncontrolled environment. The device is installed and operated without restriction.