



TEST REPORT

FCC PART 15.247

Report Reference No. : CTL1811201051-WF02

Compiled by: Happy Guo
(position+printed name+signature) (File administrators)

Happy Guo

Tested by: Nice Nong
(position+printed name+signature) (Test Engineer)

NICE NONG

Approved by: Ivan Xie
(position+printed name+signature) (Manager)

Ivan Xie

Product Name : Vehicle diagnostic equipment

Model/Type reference : i70

List Model(s)..... : GT60

Trade Mark..... : FOXWELL, TWIN BUSCH

FCC ID..... : 2ASC2-I70

Applicant's name : Shenzhen Foxwell Technology Co., Ltd.

Address of applicant : 5/F, Plant C, Baocheng 71st Zone, Xin'an Street, Baoan District, Shenzhen 518106, China

Test Firm..... : Shenzhen CTL Testing Technology Co., Ltd.

Address of Test Firm : Floor 1-A, Baisha Technology Park, No.3011, Shaheci Road, Nanshan District, Shenzhen, China 518055

Test specification..... :

Standard : FCC Part 15.247: Operation within the bands 902-928 MHz, 2400-2483.5 MHz and 5725-5850 MHz.

TRF Originator : Shenzhen CTL Testing Technology Co., Ltd.

Master TRF..... : Dated 2011-01

Date of Receipt..... : Dec. 03, 2018

Date of Test Date..... : Dec. 03, 2018–Dec. 28, 2018

Data of Issue..... : Jan. 03, 2019

Result..... : Pass

Shenzhen CTL Testing Technology Co., Ltd. All rights reserved.

This publication may be reproduced in whole or in part for non-commercial purposes as long as the Shenzhen CTL Testing Technology Co., Ltd. is acknowledged as copyright owner and source of the material. Shenzhen CTL Testing Technology Co., Ltd. takes no responsibility for and will not assume liability for damages resulting from the reader's interpretation of the reproduced material due to its placement and context.

TEST REPORT

Test Report No. : CTL1811201051-WF02	Jan. 03, 2019
	Date of issue

Equipment under Test : Vehicle diagnostic equipment

Model /Type : i70

Listed Models : GT60

Applicant : **Shenzhen Foxwell Technology Co., Ltd.**

Address : 5/F, Plant C, Baocheng 71st Zone, Xin'an Street,
Baoan District, Shenzhen 518106, China

Manufacturer : **Shenzhen Foxwell Technology Co., Ltd.**

Address : 5/F, Plant C, Baocheng 71st Zone, Xin'an Street,
Baoan District, Shenzhen 518106, China

Test result	Pass *
--------------------	---------------

* In the configuration tested, the EUT complied with the standards specified page 5.

The test report merely corresponds to the test sample.

It is not permitted to copy extracts of these test result without the written permission of the test laboratory.

Table of Contents

Page

- 1. SUMMARY 5**
 - 1.1. TEST STANDARDS 5
 - 1.2. TEST DESCRIPTION 5
 - 1.3. TEST FACILITY 6
 - 1.4. STATEMENT OF THE MEASUREMENT UNCERTAINTY 6

- 2. GENERAL INFORMATION 7**
 - 2.1. ENVIRONMENTAL CONDITIONS 7
 - 2.2. GENERAL DESCRIPTION OF EUT 7
 - 2.3. DESCRIPTION OF TEST MODES AND TEST FREQUENCY 7
 - 2.4. EQUIPMENTS USED DURING THE TEST 8
 - 2.5. SPECIAL ACCESSORIES 9
 - 2.6. RELATED SUBMITTAL(S) / GRANT (S) 9
 - 2.7. MODIFICATIONS 9

- 3. TEST CONDITIONS AND RESULTS 10**
 - 3.1. CONDUCTED EMISSIONS TEST 10
 - 3.2. RADIATED EMISSIONS AND BAND EDGE 13
 - 3.3. MAXIMUM CONDUCTED OUTPUT POWER 20
 - 3.4. POWER SPECTRAL DENSITY 21
 - 3.5. 6DB BANDWIDTH 24
 - 3.6. OUT-OF-BAND EMISSIONS 27
 - 3.7. ANTENNA REQUIREMENT 36

- 4. TEST SETUP PHOTOS OF THE EUT 37**

- 5. PHOTOS OF THE EUT 38**

1. SUMMARY

1.1. TEST STANDARDS

The tests were performed according to following standards:

[FCC Rules Part 15.247](#): Frequency Hopping, Direct Spread Spectrum and Hybrid Systems that are in operation within the bands of 902-928 MHz, 2400-2483.5 MHz, and 5725-5850 MHz

[ANSI C63.10: 2013](#): American National Standard for Testing Unlicensed Wireless Devices

[KDB558074 D01 V05](#): Guidance for Performing Compliance Measurements on Digital Transmission Systems (DTS) Operating Under §15.247

1.2. Test Description

FCC PART 15.247		
FCC Part 15.207	AC Power Conducted Emission	PASS
FCC Part 15.247(a)(2)	6dB Bandwidth	PASS
FCC Part 15.247(d)	Spurious RF Conducted Emission	PASS
FCC Part 15.247(b)	Maximum Conducted Output Power	PASS
FCC Part 15.247(e)	Power Spectral Density	PASS
FCC Part 15.109/ 15.205/ 15.209	Radiated Emissions	PASS
FCC Part 15.247(d)	Band Edge	PASS
FCC Part 15.203/15.247 (b)	Antenna Requirement	PASS

1.3. Test Facility

1.3.1 Address of the test laboratory

Shenzhen CTL Testing Technology Co., Ltd.

Floor 1-A, Baisha Technology Park, No. 3011, Shahexi Road, Nanshan, Shenzhen 518055 China

The 3m-Semi anechoic test site fulfils CISPR 16-1-4 according to ANSI C63.4:2014 and CISPR 16-1-4:2010 SVSWR requirement for radiated emission above 1GHz.

1.3.2 Laboratory accreditation

The test facility is recognized, certified, or accredited by the following organizations:

IC Registration No.: 9618B

The 3m alternate test site of Shenzhen CTL Testing Technology Co., Ltd. EMC Laboratory has been registered by Certification and Engineer Bureau of Industry Canada for the performance of with Registration No.: 9618B on November 13, 2013.

FCC-Registration No.: 399832

Shenzhen CTL Testing Technology Co., Ltd. EMC Laboratory has been registered and fully described in a report filed with the (FCC) Federal Communications Commission. The acceptance letter from the FCC is maintained in our files. Registration 399832, December 08, 2017.

1.4. Statement of the measurement uncertainty

The data and results referenced in this document are true and accurate. The reader is cautioned that there may be errors within the calibration limits of the equipment and facilities. The measurement uncertainty was calculated for all measurements listed in this test report acc. to CISPR 16 - 4 "Specification for radio disturbance and immunity measuring apparatus and methods – Part 4: Uncertainty in EMC Measurements" and is documented in the Shenzhen CTL Testing Technology Co., Ltd. quality system acc. to DIN EN ISO/IEC 17025. Furthermore, component and process variability of devices similar to that tested may result in additional deviation. The manufacturer has the sole responsibility of continued compliance of the device.

Hereafter the best measurement capability for CTL laboratory is reported:

Test	Measurement Uncertainty	Notes
Transmitter power conducted	±0.57 dB	(1)
Transmitter power Radiated	±2.20 dB	(1)
Conducted spurious emission 9KHz-40 GHz	±2.20 dB	(1)
Occupied Bandwidth	±0.01ppm	(1)
Radiated Emission 30~1000MHz	±4.10dB	(1)
Radiated Emission Above 1GHz	±4.32dB	(1)
Conducted Disturbance0.15~30MHz	±3.20dB	(1)

(1) This uncertainty represents an expanded uncertainty expressed at approximately the 95% confidence level using a coverage factor of k=2.

2. GENERAL INFORMATION

2.1. Environmental conditions

During the measurement the environmental conditions were within the listed ranges:

Normal Temperature:	25°C
Relative Humidity:	55 %
Air Pressure:	101 kPa

2.2. General Description of EUT

Product Name:	Vehicle diagnostic equipment
Model/Type reference:	i70
Power supply:	DC 5V from adapter
Adapter information:	Model: JK050300-S04US Input: AC 100-240V 50/60Hz 0.5A Output: DC 5V 3A
Hardware version:	D10_MB_V1.0
Software version:	0.0.8
WIFI :	
Supported type:	802.11b/802.11g/802.11n(H20)/802.11n(H40)
Modulation:	802.11b: DSSS 802.11g/802.11n(H20)/802.11n(H40): OFDM
Operation frequency:	802.11b/802.11g/802.11n(H20): 2412MHz~2462MHz 802.11n(H40): 2422MHz~2452MHz
Channel number:	802.11b/802.11g/802.11n(H20): 11 802.11n(H40): 7
Channel separation:	5MHz
Antenna type:	FPC Antenna
Antenna gain:	0.5dBi

Note: For more details, please refer to the user's manual of the EUT.

2.3. Description of Test Modes and Test Frequency

The Applicant provides communication tools software (Engineering mode) to control the EUT for staying in continuous transmitting (Duty Cycle more than 98%) and receiving mode for testing.

There are 11 channels provided to the EUT and Channel 01/06/11 were selected for WIFI test.

Operation Frequency WIFI :

Channel	Frequency(MHz)	Channel	Frequency(MHz)
1	2412	8	2447
2	2417	9	2452
3	2422	10	2457
4	2427	11	2462
5	2432		
6	2437		
7	2442		

Note: The line display in grey were the channel selected for testing

Data Rate Used:

Preliminary tests were performed in different data rate to find the worst radiated emission. The data rate shown in the table below is the worst-case rate with respect to the specific test item. Investigation has been done on all the possible configurations for searching the worst cases. The following table is a list of the test modes shown in this test report.

Test Items	Mode	Data Rate	Channel
Maximum Conducted Output Power Power Spectral Density 6dB Bandwidth Spurious RF conducted emission Radiated Emission 9kHz~1GHz& Radiated Emission 1GHz~10th Harmonic	11b/DSSS	1 Mbps	1/6/11
	11g/OFDM	6 Mbps	1/6/11
	11n(20MHz)/OFDM	6.5Mbps	1/6/11
	11n(40MHz)/OFDM	13.5Mbps	3/6/9
Band Edge	11b/DSSS	1 Mbps	1/11
	11g/OFDM	6 Mbps	1/11
	11n(20MHz)/OFDM	6.5Mbps	1/11
	11n(40MHz)/OFDM	13.5Mbps	3/9

2.4. Equipments Used during the Test

Test Equipment	Manufacturer	Model No.	Serial No.	Calibration Date recent	Calibration Due Date
LISN	R&S	ENV216	3560.6550.12	2018/06/01	2019/05/31
LISN	R&S	ESH2-Z5	860014/010	2018/06/01	2019/05/31
Power Meter	Agilent	U2531A	TW53323507	2018/06/01	2019/05/31
Power Sensor	Agilent	U2021XA	MY5365004	2018/05/20	2019/05/19
EMI Test Receiver	R&S	ESCI	103710	2018/06/01	2019/05/31
Spectrum Analyzer	Agilent	E4407B	MY41440676	2018/05/20	2019/05/19
Spectrum Analyzer	Agilent	N9020	US46220290	2018/01/16	2019/01/15
Controller	EM Electronics	Controller EM 1000	N/A	2018/05/20	2019/05/19
Active Loop Antenna	Daze	ZN30900A	N/A	2018/05/18	2019/05/17
Bilog Antenna	Schwarzbeck	VULB 9168	00824	2018/10/25	2019/10/24
Horn Antenna	Sunol Sciences Corp.	DRH-118	A062013	2018/05/18	2019/05/17
Horn Antenna	SCHWARZBACK	BBHA 9170	BBHA9170184	2018/05/18	2019/05/17
Amplifier	Agilent	8349B	3008A02306	2018/05/18	2019/05/17
Amplifier	Agilent	8447D	2944A10176	2018/05/18	2019/05/17
Temperature/Humidity Meter	Gangxing	CTH-608	02	2018/05/19	2019/05/18
High-Pass Filter	K&L	9SH10-2700/X12750-O/O	N/A	2018/05/19	2019/05/18
High-Pass Filter	K&L	41H10-1375/U12750-O/O	N/A	2018/05/19	2019/05/18
Coaxial Cables	HUBER+SUHNER	SUCOFLEX 104PEA-10M	10m	2018/06/01	2019/05/31
Coaxial Cables	HUBER+SUHNER	SUCOFLEX 104PEA-3M	3m	2018/06/01	2019/05/31
Coaxial Cables	HUBER+SUHNER	SUCOFLEX 104PEA-3M	3m	2018/06/01	2019/05/31
RF Cable	Megalon	RF-A303	N/A	2018/06/01	2019/05/31

EMI Test Software	R&S	ES-K1	V1.7.1	2018/06/01	2019/05/31
EMI Test Software	AUDIX	E3	V6.0	2018/06/01	2019/05/31

The calibration interval was one year

2.5. Special Accessories

Manufacturer	Description	Model	Serial Number	Certificate
Altima	OBD	OBD CAN	IN4AL24E49C193655	SDOC
Delta	Switching Power Adapter	GFP361DA-1230-1	1506-0000156	SDOC

2.6. Related Submittal(s) / Grant (s)

This submittal(s) (test report) is intended to comply with Section 15.247 of the FCC Part 15, Subpart C Rules.

2.7. Modifications

No modifications were implemented to meet testing criteria.

3. TEST CONDITIONS AND RESULTS

3.1. Conducted Emissions Test

LIMIT

FCC CFR Title 47 Part 15 Subpart C Section 15.207

Frequency range (MHz)	Limit (dBuV)	
	Quasi-peak	Average
0.15-0.5	66 to 56*	56 to 46*
0.5-5	56	46
5-30	60	50

* Decreases with the logarithm of the frequency.

TEST CONFIGURATION

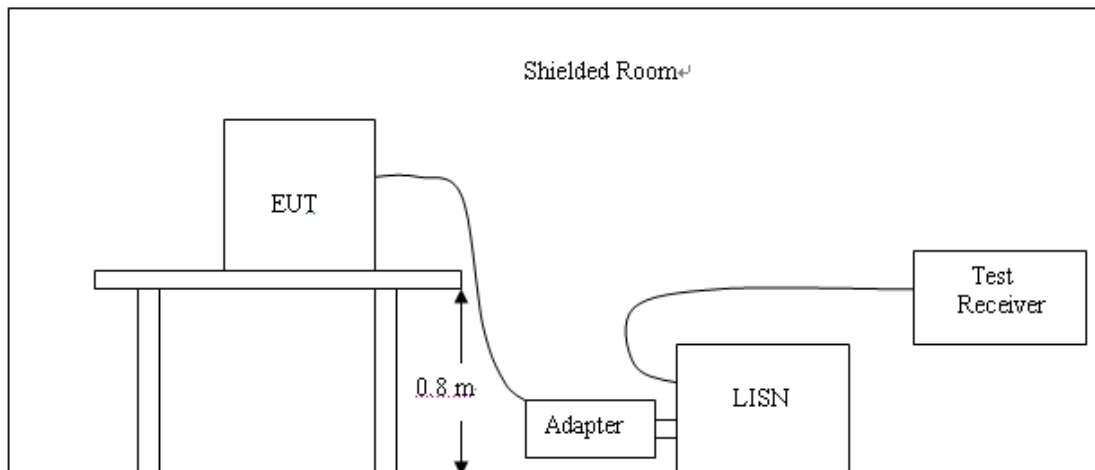

TEST PROCEDURE

1. The equipment was set up as per the test configuration to simulate typical actual usage per the user's manual. The EUT is a tabletop system; a wooden table with a height of 0.8 meters is used and is placed on the ground plane as per ANSI C63.10:2013.
2. Support equipment, if needed, was placed as per ANSI C63.10:2013.
3. All I/O cables were positioned to simulate typical actual usage as per ANSI C63.10:2013.
4. The adapter received AC120V/60Hz power through a Line Impedance Stabilization Network (LISN) which supplied power source and was grounded to the ground plane.
5. All support equipments received AC power from a second LISN, if any.
6. The EUT test program was started. Emissions were measured on each current carrying line of the EUT using a spectrum Analyzer / Receiver connected to the LISN powering the EUT. The LISN has two monitoring points: Line 1 (Hot Side) and Line 2 (Neutral Side). Two scans were taken: one with Line 1 connected to Analyzer / Receiver and Line 2 connected to a 50 ohm load; the second scan had Line 1 connected to a 50 ohm load and Line 2 connected to the Analyzer / Receiver.
7. Analyzer / Receiver scanned from 150 KHz to 30MHz for emissions in each of the test modes.
8. During the above scans, the emissions were maximized by cable manipulation.

TEST RESULTS

Remark:

1. All modes of 802.11b/g/n were tested at Low, Middle, and High channel; only the worst result of 802.11b CH11 was reported as below:
2. Both 120 VAC, 50/60 Hz and 240 VAC, 50/60 Hz power supply have been tested, only the worst result of 120 VAC, 60 Hz was reported as below:

Test Mode	WIFI	Line:	L
------------------	-------------	--------------	----------

SCAN TABLE: "Voltage (9K-30M) FIN"

Short Description: 150K-30M Voltage

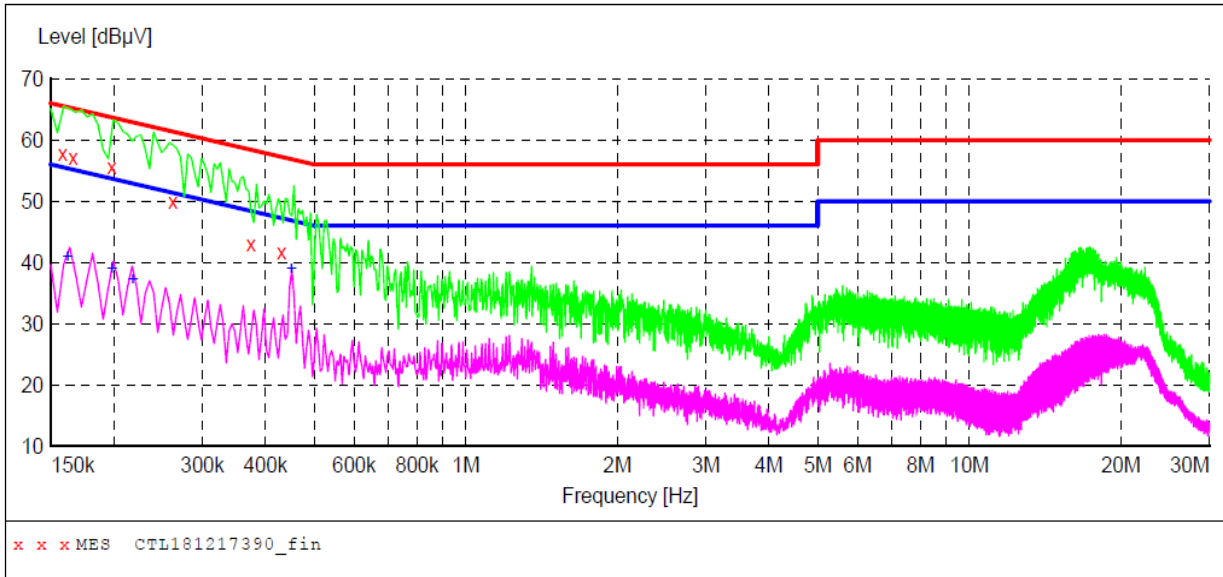

MEASUREMENT RESULT: "CTL181217390_fin"

2018-12-18 04:51??

Frequency MHz	Level dBµV	Transd dB	Limit dBµV	Margin dB	Detector	Line	PE
0.158000	57.70	10.2	66	7.9	QP	L1	GND
0.166000	57.10	10.2	65	8.1	QP	L1	GND
0.198000	55.70	10.2	64	8.0	QP	L1	GND
0.262000	49.90	10.2	61	11.5	QP	L1	GND
0.374000	43.10	10.2	58	15.3	QP	L1	GND
0.430000	41.70	10.2	57	15.6	QP	L1	GND

MEASUREMENT RESULT: "CTL181217390_fin2"

2018-12-18 04:51??

Frequency MHz	Level dBµV	Transd dB	Limit dBµV	Margin dB	Detector	Line	PE
0.162000	40.80	10.2	55	14.6	AV	L1	GND
0.198000	38.80	10.2	54	14.9	AV	L1	GND
0.218000	37.10	10.2	53	15.8	AV	L1	GND
0.450000	38.90	10.2	47	8.0	AV	L1	GND

Test Mode	WIFI	Line:	N
-----------	------	-------	---

SCAN TABLE: "Voltage (9K-30M) FIN"

Short Description: 150K-30M Voltage

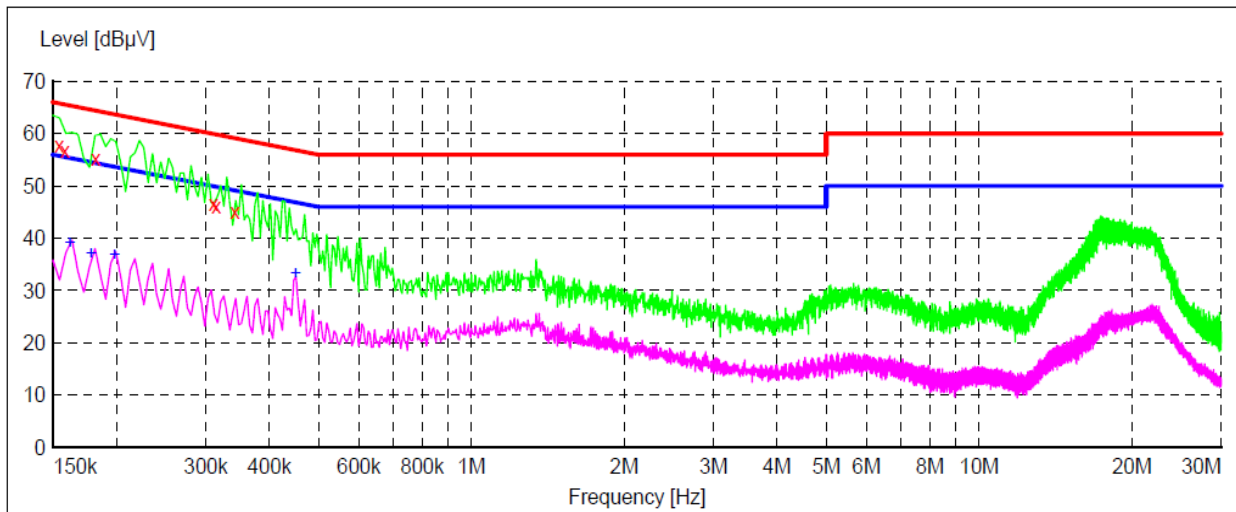

x x x MES CTL181217391_fin

MEASUREMENT RESULT: "CTL181217391_fin"

2018-12-18 04:54??

Frequency MHz	Level dBµV	Transd dB	Limit dBµV	Margin dB	Detector	Line	PE
0.154000	57.70	10.2	66	8.1	QP	N	GND
0.158000	56.80	10.2	66	8.8	QP	N	GND
0.182000	55.30	10.2	64	9.1	QP	N	GND
0.310000	46.70	10.2	60	13.3	QP	N	GND
0.314000	46.20	10.2	60	13.7	QP	N	GND
0.342000	45.20	10.2	59	14.0	QP	N	GND

MEASUREMENT RESULT: "CTL181217391_fin2"

2018-12-18 04:54??

Frequency MHz	Level dBµV	Transd dB	Limit dBµV	Margin dB	Detector	Line	PE
0.162000	38.90	10.2	55	16.5	AV	N	GND
0.178000	36.90	10.2	55	17.7	AV	N	GND
0.198000	36.70	10.2	54	17.0	AV	N	GND
0.450000	33.20	10.2	47	13.7	AV	N	GND

3.2. Radiated Emissions and Band Edge

Limit

For intentional device, according to § 15.209(a), the general requirement of field strength of radiated emission out of authorized band shall not exceed the following table at a 3 meters measurement distance.

In addition, radiated emissions which fall in the restricted bands, as defined in §15.205(a), must also comply with the radiated emission limits specified in §15.209(a)

Radiated emission limits

Frequency (MHz)	Distance (Meters)	Radiated (dB μ V/m)	Radiated (μ V/m)
0.009-0.49	3	$20\log(2400/F(\text{KHz}))+40\log(300/3)$	$2400/F(\text{KHz})$
0.49-1.705	3	$20\log(24000/F(\text{KHz}))+40\log(30/3)$	$24000/F(\text{KHz})$
1.705-30	3	$20\log(30)+40\log(30/3)$	30
30-88	3	40.0	100
88-216	3	43.5	150
216-960	3	46.0	200
Above 960	3	54.0	500

TEST CONFIGURATION

(A) Radiated Emission Test Set-Up, Frequency Below 30MHz

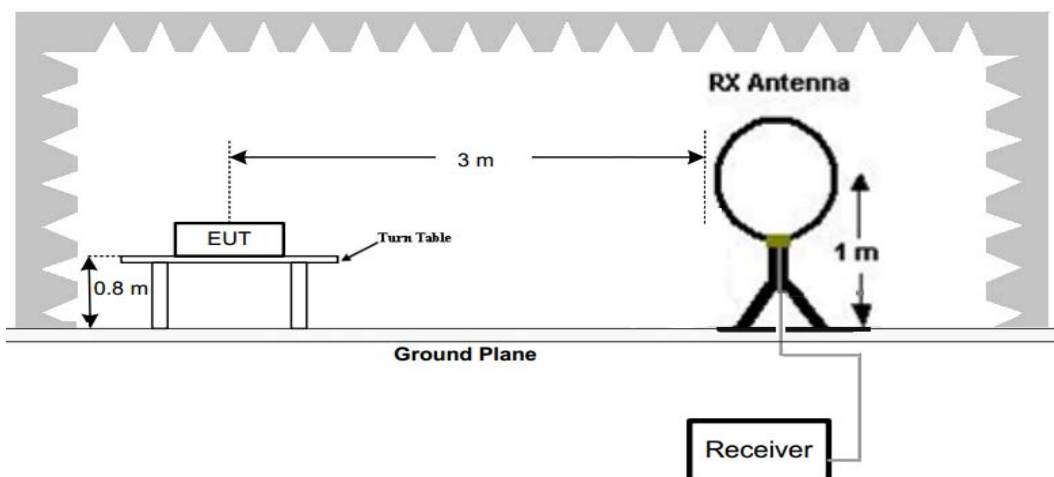

(B) Radiated Emission Test Set-Up, Frequency below 1000MHz

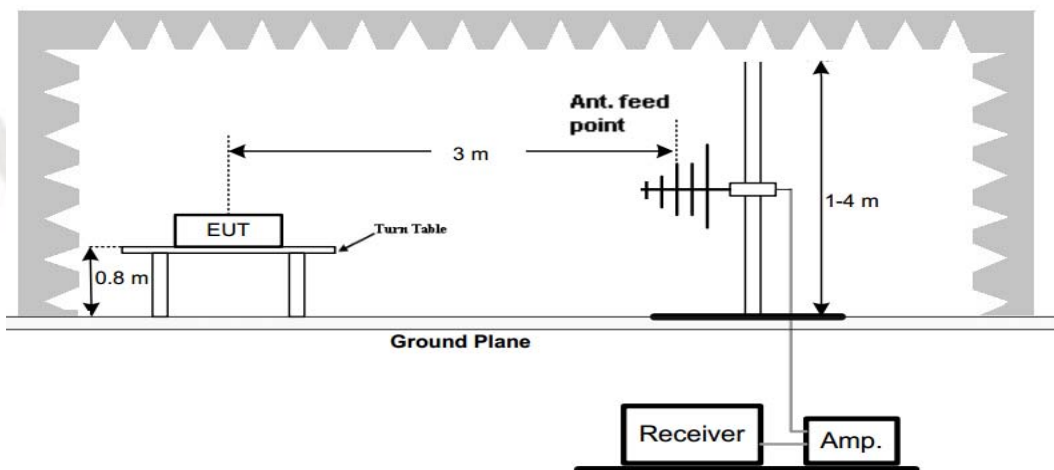

(C) Radiated Emission Test Set-Up, Frequency above 1000MHz

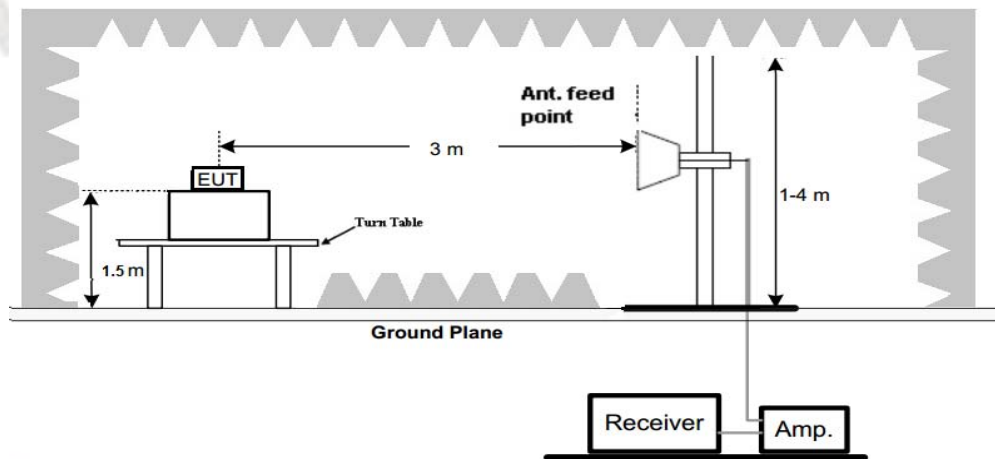

Test Procedure

- Below 1GHz measurement the EUT is placed on a turntable which is 0.8m above ground plane, and above 1GHz measurement EUT was placed on a low permittivity and low loss tangent turn table which is 1.5m above ground plane.
- Maximum procedure was performed by raising the receiving antenna from 1m to 4m and rotating the turn table from 0°C to 360°C to acquire the highest emissions from EUT
- And also, each emission was to be maximized by changing the polarization of receiving antenna both horizontal and vertical.
- Repeat above procedures until all frequency measurements have been completed.
- Radiated emission test frequency band from 9KHz to 25GHz.
- The distance between test antenna and EUT as following table states:

Test Frequency range	Test Antenna Type	Test Distance
9KHz-30MHz	Active Loop Antenna	3
30MHz-1GHz	Bilog Antenna	3
1GHz-18GHz	Horn Antenna	3
18GHz-25GHz	Horn Antenna	1

- Setting test receiver/spectrum as following table states:

Test Frequency range	Test Receiver/Spectrum Setting	Detector
9KHz-150KHz	RBW=200Hz/VBW=3KHz, Sweep time=Auto	QP
150KHz-30MHz	RBW=9KHz/VBW=100KHz, Sweep time=Auto	QP
30MHz-1GHz	RBW=120KHz/VBW=1000KHz, Sweep time=Auto	QP
1GHz-40GHz	Peak Value: RBW=1MHz/VBW=3MHz, Sweep time=Auto Average Value: RBW=1MHz/VBW=10Hz, Sweep time=Auto	Peak

TEST RESULTS

Remark:

- This test was performed with EUT in X, Y, Z position and the worse case was found when EUT in X position.
- All three channels (lowest/middle/highest) of each mode were measured below 1GHz and recorded worst case at 802.11b low channel.
- All three channels (lowest/middle/highest) of each mode were measured above 1GHz and recorded worst case at 802.11b mode.
- Radiated emission test from 9 KHz to 10th harmonic of fundamental was verified, and no emission found except system noise floor in 9 KHz to 30MHz and not recorded in this report.

For 30MHz-1GHz

Test mode:	WIFI	Polarization:	Horizontal
------------	------	---------------	------------

SWEEP TABLE: "test (30M-1G)"

Short Description: Field Strength
 Start Stop Detector Meas. IF Transducer
 Frequency Frequency Time Bandw.
 30.0 MHz 1.0 GHz MaxPeak 200.0 ms 120 kHz VULB 9168

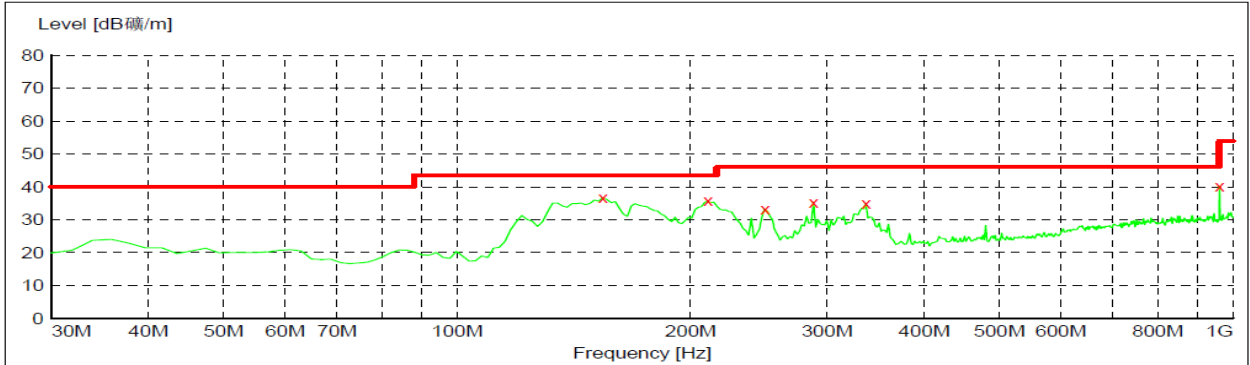

x x x MES CTL181214265_red

MEASUREMENT RESULT: "CTL181214265_red"

2018-12-14 9:04

Frequency MHz	Level dB/m	Transd dB	Limit dB/m	Margin dB	Det.	Height cm	Azimuth deg	Polarization
154.160000	36.70	15.2	43.5	6.8	---	0.0	0.00	HORIZONTAL
210.420000	35.70	11.3	43.5	7.8	---	0.0	0.00	HORIZONTAL
249.220000	33.20	12.8	46.0	12.8	---	0.0	0.00	HORIZONTAL
288.020000	35.40	13.8	46.0	10.6	---	0.0	0.00	HORIZONTAL
336.520000	34.90	15.0	46.0	11.1	---	0.0	0.00	HORIZONTAL
961.200000	40.30	24.3	53.9	13.6	---	0.0	0.00	HORIZONTAL

Test mode:	WIFI	Polarization:	Vertical
------------	------	---------------	----------

SWEEP TABLE: "test (30M-1G)"

Short Description: Field Strength
 Start Stop Detector Meas. IF Transducer
 Frequency Frequency Time Bandw.
 30.0 MHz 1.0 GHz MaxPeak 200.0 ms 120 kHz VULB 9168

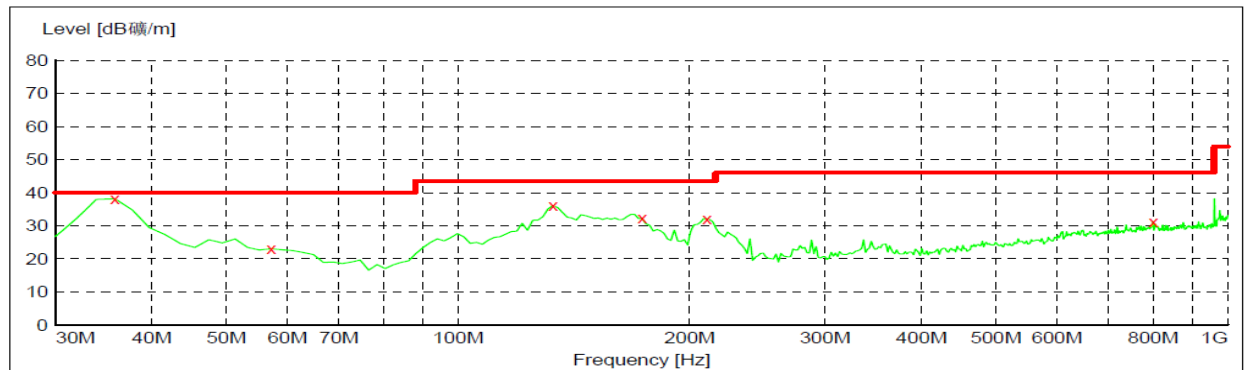

x x x MES CTL181214266_red

MEASUREMENT RESULT: "CTL181214266_red"

2018-12-14 9:06

Frequency MHz	Level dB/m	Transd dB	Limit dB/m	Margin dB	Det.	Height cm	Azimuth deg	Polarization
35.820000	38.20	14.2	40.0	1.8	---	0.0	0.00	VERTICAL
57.160000	23.10	13.6	40.0	16.9	---	0.0	0.00	VERTICAL
132.820000	36.10	14.0	43.5	7.4	---	0.0	0.00	VERTICAL
173.560000	32.30	13.7	43.5	11.2	---	0.0	0.00	VERTICAL
210.420000	32.20	11.3	43.5	11.3	---	0.0	0.00	VERTICAL
800.180000	31.30	22.7	46.0	14.7	---	0.0	0.00	VERTICAL

For 1GHz to 25GHz

802.11b Mode (above 1GHz)

Note: 802.11b/802.11g/802.11n (H20) /802.11n (H40) all have been tested, only worse case 802.11b is reported:

Frequency(MHz):			2412.00		Polarity:			HORIZONTAL	
Frequency (MHz)	Emission Level (dBuV/m)		Limit (dBuV/m)	Margin (dB)	Raw Value (dBuV)	Antenna Factor (dB/m)	Cable Factor (dB)	Pre-amplifier (dB)	Correction Factor (dB/m)
4824.00	56.55	PK	74.00	17.45	52.00	33.52	6.92	35.89	4.55
4824.00	47.41	AV	54.00	6.59	42.86	33.52	6.92	35.89	4.55
5130.75	50.29	PK	74.00	23.71	43.09	34.38	7.10	34.28	7.20
5130.75	--	AV	54.00	--	--	--	--	--	--
7236.00	47.16	PK	74.00	26.84	35.89	37.10	9.19	35.02	11.27
7236.00	--	AV	54.00	--	--	--	--	--	--

Frequency(MHz):			2412.00		Polarity:			VERTICAL	
Frequency (MHz)	Emission Level (dBuV/m)		Limit (dBuV/m)	Margin (dB)	Raw Value (dBuV)	Antenna Factor (dB/m)	Cable Factor (dB)	Pre-amplifier (dB)	Correction Factor (dB/m)
4824.00	56.49	PK	74.00	17.51	51.94	33.52	6.92	35.89	4.55
4824.00	47.38	AV	54.00	6.62	42.83	33.52	6.92	35.89	4.55
5125.75	49.84	PK	74.00	24.16	42.64	34.38	7.10	34.28	7.20
5125.75	--	AV	54.00	--	--	--	--	--	--
7236.00	48.45	PK	74.00	25.55	37.18	37.10	9.19	35.02	11.27
7236.00	--	AV	54.00	--	--	--	--	--	--

Frequency(MHz):			2437.00		Polarity:			HORIZONTAL	
Frequency (MHz)	Emission Level (dBuV/m)		Limit (dBuV/m)	Margin (dB)	Raw Value (dBuV)	Antenna Factor (dB/m)	Cable Factor (dB)	Pre-amplifier (dB)	Correction Factor (dB/m)
4874.00	56.41	PK	74.00	17.59	50.17	33.59	6.95	34.30	6.24
4874.00	47.27	AV	54.00	6.73	41.03	33.59	6.95	34.30	6.24
5235.50	47.92	PK	74.00	26.08	40.32	34.56	7.15	34.11	7.60
5235.50	--	AV	54.00	--	--	--	--	--	--
7311.00	46.57	PK	74.00	27.43	34.91	37.44	9.22	35.00	11.66
7311.00	--	AV	54.00	--	--	--	--	--	--

Frequency(MHz):			2437.00		Polarity:			VERTICAL	
Frequency (MHz)	Emission Level (dBuV/m)		Limit (dBuV/m)	Margin (dB)	Raw Value (dBuV)	Antenna Factor (dB/m)	Cable Factor (dB)	Pre-amplifier (dB)	Correction Factor (dB/m)
4874.00	56.24	PK	74.00	17.76	49.90	33.59	6.95	34.20	6.34
4874.00	47.37	AV	54.00	6.63	41.03	33.59	6.95	34.20	6.34
5322.55	47.62	PK	74.00	26.38	40.72	34.07	7.05	34.22	6.90
5322.55	--	AV	54.00	--	--	--	--	--	--
7311.00	48.12	PK	74.00	25.88	36.46	37.44	9.22	35.00	11.66
7311.00	--	AV	54.00	--	--	--	--	--	--

Frequency(MHz):			2462.00		Polarity:			HORIZONTAL	
Frequency (MHz)	Emission Level (dBuV/m)		Limit (dBuV/m)	Margin (dB)	Raw Value (dBuV)	Antenna Factor (dB/m)	Cable Factor (dB)	Pre-amplifier (dB)	Correction Factor (dB/m)
4924.00	56.21	PK	74.00	17.79	53.55	33.71	6.98	35.91	4.78
4924.00	47.41	AV	54.00	6.59	43.73	33.71	6.98	35.91	4.78
5115.50	47.57	PK	74.00	26.43	41.24	34.34	7.09	34.27	7.17
5115.50	--	AV	54.00	--	--	--	--	--	--
7386.00	46.54	PK	74.00	27.46	37.40	37.61	9.25	34.98	11.88
7386.00	--	AV	54.00	--	--	--	--	--	--

Frequency(MHz):			2462.00		Polarity:			VERTICAL	
Frequency (MHz)	Emission Level (dBuV/m)		Limit (dBuV/m)	Margin (dB)	Raw Value (dBuV)	Antenna Factor (dB/m)	Cable Factor (dB)	Pre-amplifier (dB)	Correction Factor (dB/m)
4924.00	56.19	PK	74.00	17.81	51.41	33.71	6.98	35.91	4.78
4924.00	47.12	AV	54.00	6.88	42.34	33.71	6.98	35.91	4.78
5110.50	47.43	PK	74.00	26.57	40.26	34.34	7.09	34.27	7.17
5110.50	--	AV	54.00	--	--	--	--	--	--
7386.00	46.74	PK	74.00	27.26	34.86	37.61	9.25	34.98	11.88
7386.00	--	AV	54.00	--	--	--	--	--	--

REMARKS:

1. Emission level (dBuV/m) =Raw Value (dBuV)+Correction Factor (dB/m)
2. Correction Factor (dB/m) = Antenna Factor (dB/m)+Cable Factor (dB)-Pre-amplifier Factor
3. Margin value = Limit value- Emission level.
4. -- Mean the PK detector measured value is below average limit.
5. The other emission levels were very low against the limit.
6. RBW1MHz VBW3MHz Peak detector is for PK value; RBW 1MHz VBW10Hz Peak detector is for AV value.

Results of Band Edges Test (Radiated)

Note: 802.11b/802.11g/802.11n (H20) /802.11n (H40) all have been tested; only worse case 802.11b is reported:

Frequency(MHz):			2412.00		Polarity:			HORIZONTAL	
Frequency (MHz)	Emission Level (dBuV/m)		Limit (dBuV/m)	Margin (dB)	Raw Value (dBuV)	Antenna Factor (dB/m)	Cable Factor (dB)	Pre-amplifier (dB)	Correction Factor (dB/m)
2412.00	106.11	PK	--	--	72.72	28.78	4.61	0.00	33.39
2412.00	97.27	AV	--	--	63.88	28.78	4.61	0.00	33.39
2355.75	43.86	PK	74.00	30.14	10.78	28.52	4.56	0.00	33.08
2355.75	--	AV	54.00	--	--	--	--	--	--
2390.00	48.54	PK	74.00	25.46	15.22	28.72	4.60	0.00	33.32
2390.00	--	AV	54.00	--	--	--	--	--	--
2400.00	51.69	PK	74.00	22.31	18.30	28.78	4.61	0.00	33.39
2400.00	--	AV	54.00	--	--	--	--	--	--

Frequency(MHz):			2412.00		Polarity:			VERTICAL	
Frequency (MHz)	Emission Level (dBuV/m)		Limit (dBuV/m)	Margin (dB)	Raw Value (dBuV)	Antenna Factor (dB/m)	Cable Factor (dB)	Pre-amplifier (dB)	Correction Factor (dB/m)
2412.00	105.09	PK	--	--	71.70	28.78	4.61	0.00	33.39
2412.00	96.45	AV	--	--	63.06	28.78	4.61	0.00	33.39
2352.15	44.57	PK	74.00	29.43	11.49	28.52	4.56	0.00	33.08
2352.15	--	AV	54.00	--	--	--	--	--	--
2390.00	50.48	PK	74.00	23.52	17.16	28.72	4.60	0.00	33.32
2390.00	--	AV	54.00	--	--	--	--	--	--
2400.00	52.76	PK	74.00	21.24	19.37	28.78	4.61	0.00	33.39
2400.00	--	AV	54.00	--	--	--	--	--	--

Frequency(MHz):			2462.00		Polarity:			HORIZONTAL	
Frequency (MHz)	Emission Level (dBuV/m)		Limit (dBuV/m)	Margin (dB)	Raw Value (dBuV)	Antenna Factor (dB/m)	Cable Factor (dB)	Pre-amplifier (dB)	Correction Factor (dB/m)
2462.00	105.82	PK	--	--	72.20	28.92	4.70	0.00	33.62
2462.00	97.07	AV	--	--	63.45	28.92	4.70	0.00	33.62
2483.50	50.05	PK	74.00	23.95	16.42	28.93	4.70	0.00	33.63
2483.50	--	AV	54.00	--	--	--	--	--	--
2485.55	48.77	PK	74.00	25.23	15.11	28.95	4.71	0.00	33.66
2485.55	--	AV	54.00	--	--	--	--	--	--
2500.00	43.62	PK	74.00	30.38	9.94	28.96	4.72	0.00	33.68
2500.00	--	AV	54.00	--	--	--	--	--	--

Frequency(MHz):			2462.00		Polarity:			VERTICAL	
Frequency (MHz)	Emission Level (dBuV/m)		Limit (dBuV/m)	Margin (dB)	Raw Value (dBuV)	Antenna Factor (dB/m)	Cable Factor (dB)	Pre-amplifier (dB)	Correction Factor (dB/m)
2462.00	105.88	PK	--	--	72.26	28.92	4.70	0.00	33.62
2462.00	96.04	AV	--	--	62.42	28.92	4.70	0.00	33.62
2483.50	51.23	PK	74.00	22.77	17.60	28.93	4.70	0.00	33.63
2483.50	--	AV	54.00	--	--	--	--	--	--
2487.75	49.65	PK	74.00	24.35	15.99	28.95	4.71	0.00	33.66
2487.75	--	AV	54.00	--	--	--	--	--	--
2500.00	44.17	PK	74.00	29.83	10.49	28.96	4.72	0.00	33.68
2500.00	--	AV	54.00	--	--	--	--	--	--

REMARKS:

1. Emission level (dBuV/m) =Raw Value (dBuV)+Correction Factor (dB/m)
2. Correction Factor (dB/m) = Antenna Factor (dB/m)+Cable Factor (dB)-Pre-amplifier Factor
3. Margin value = Limit value- Emission level.
4. -- Mean the PK detector measured value is below average limit.
5. The other emission levels were very low against the limit.
6. RBW1MHz VBW3MHz Peak detector is for PK value; RBW 1MHz VBW10Hz Peak detector is for AV value.
7. For fundamental frequency, RBW 3MHz VBW 3MHz Peak detector is for PK Value; RMS detector is for AV value.

3.3. Maximum Conducted Output Power

Limit

The Maximum Peak Output Power Measurement is 30dBm.

Test Procedure

Remove the antenna from the EUT and then connect a low loss RF cable from the antenna port to the power sensor.

Test Configuration

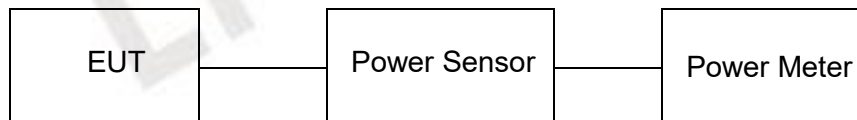

Test Results

WIFI				
Type	Channel	Output power (dBm)	Limit (dBm)	Result
802.11b	01	8.86	30.00	Pass
	06	8.47		
	11	8.48		
802.11g	01	6.75	30.00	Pass
	06	8.33		
	11	6.72		
802.11n(HT20)	01	7.01	30.00	Pass
	06	8.44		
	11	6.88		
802.11n(HT40)	03	7.69	30.00	Pass
	06	8.22		
	09	7.82		

Note:

- 1) Measured output power at difference data rate for each mode and recorded worst case for each mode.
- 2) Test results including cable loss;
- 3) Worst case data at 1Mbps at IEEE 802.11b; 6Mbps at IEEE 802.11g; 6.5Mbps at IEEE 802.11n HT20; 13.5Mbps at IEEE 802.11n HT40.

3.4. Power Spectral Density

Limit

For digitally modulated systems, the power spectral density conducted from the intentional radiator to the antenna shall not be greater than 8 dBm in any 3 kHz band during any time interval of continuous transmission.

Test Procedure

1. Use this procedure when the maximum peak conducted output power in the fundamental emission is used to demonstrate compliance.
2. Set the RBW \geq 3 kHz.
3. Set the VBW \geq 3 \times RBW.
4. Set the span to 1.5 times the DTS channel bandwidth.
5. Detector = peak.
6. Sweep time = auto couple.
7. Trace mode = max hold.
8. Allow trace to fully stabilize.
9. Use the peak marker function to determine the maximum power level.
10. If measured value exceeds limit, reduce RBW (no less than 3 kHz) and repeat.
11. The resulting peak PSD level must be 8dBm.

Test Configuration

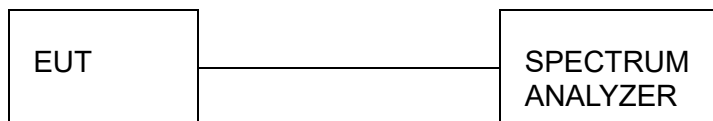

Test Results

WIFI				
Type	Channel	Power Spectral Density (dBm/3KHz)	Limit (dBm/3KHz)	Result
802.11b	01	-23.489	8.00	Pass
	06	-23.985		
	11	-23.891		
802.11g	01	-18.451	8.00	Pass
	06	-16.596		
	11	-18.146		
802.11n(HT20)	01	-18.379	8.00	Pass
	06	-16.862		
	11	-17.922		
802.11n(HT40)	03	-18.281	8.00	Pass
	06	-17.092		
	09	-17.143		

Note:

- 1) Measured peak power spectrum density at difference data rate for each mode and recorded worst case for each mode.
- 2) Test results including cable loss;
- 3) Worst case data at 1Mbps at IEEE 802.11b; 6Mbps at IEEE 802.11g; 6.5Mbps at IEEE 802.11n HT20; 13.5Mbps at IEEE 802.11n HT40.

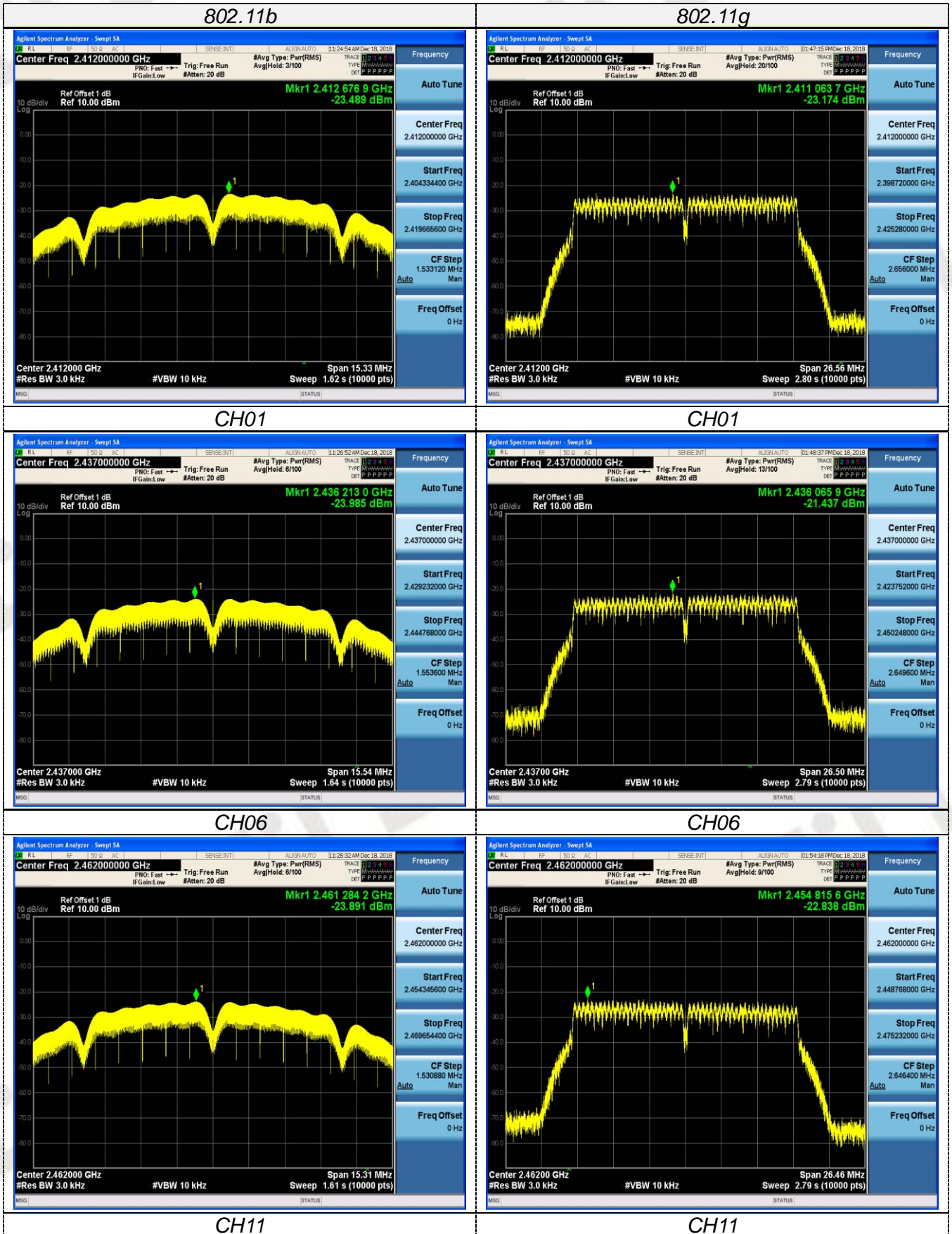

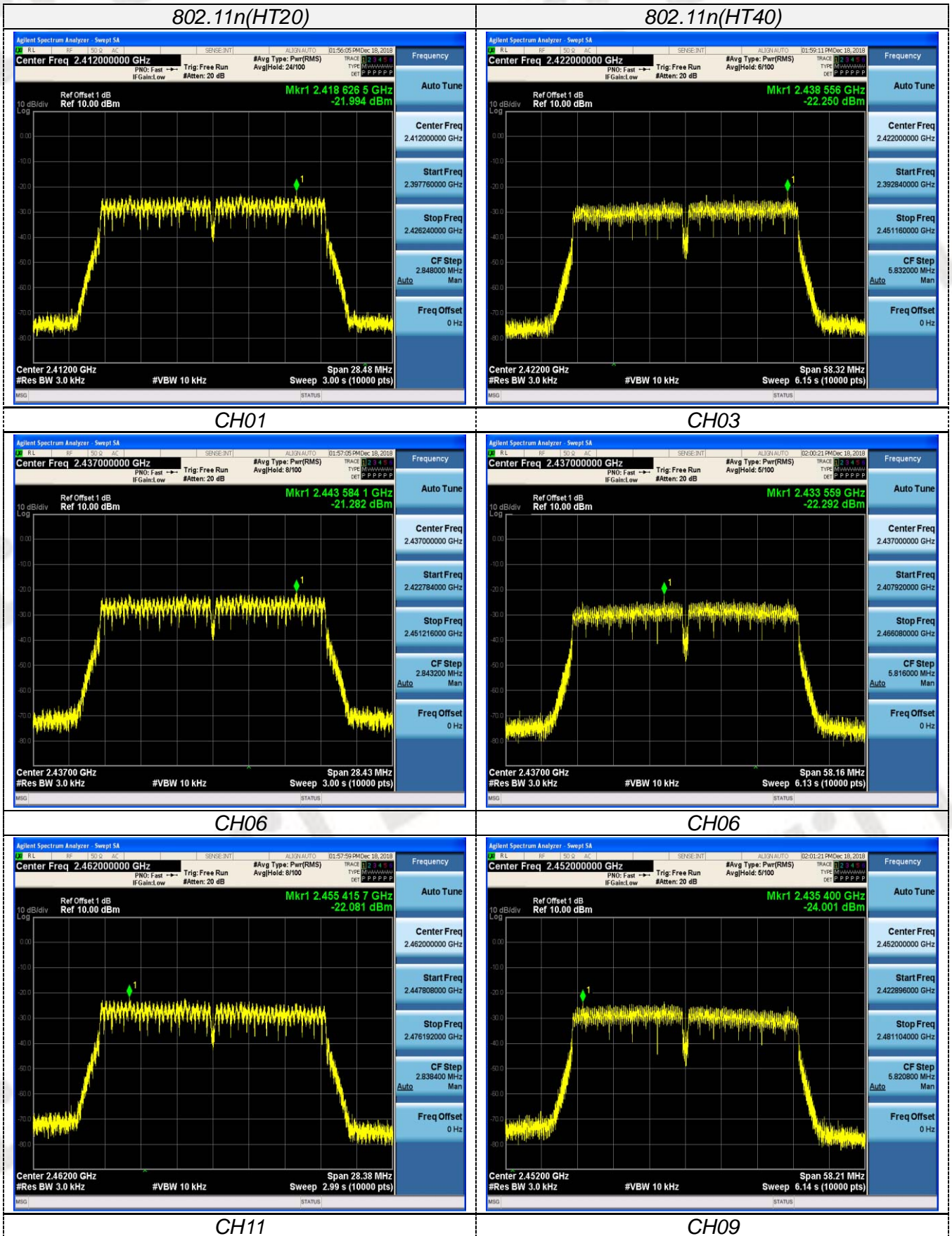

3.5. 6dB Bandwidth

Limit

For digital modulation systems, the minimum 6 dB bandwidth shall be at least 500 kHz

Test Procedure

The transmitter output was connected to the spectrum analyzer through an attenuator. The bandwidth of the fundamental frequency was measured by spectrum analyzer with 100 KHz RBW and 300 KHz VBW. The 6dB bandwidth is defined as the total spectrum the power of which is higher than peak power minus 6dB.

Test Configuration

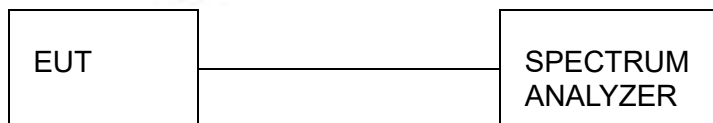

Test Results

WIFI

Type	Channel	6dB Bandwidth (MHz)	99% OBW (MHz)	Limit (KHz)	Result
802.11b	01	9.582	14.209	≥500	Pass
	06	9.710	14.348		
	11	9.568	14.187		
802.11g	01	16.60	16.539	≥500	Pass
	06	16.56	16.501		
	11	16.54	16.486		
802.11n(HT20)	01	17.80	17.664	≥500	Pass
	06	17.77	17.647		
	11	17.74	17.651		
802.11n(HT40)	03	36.45	36.084	≥500	Pass
	06	36.35	35.969		
	09	36.38	35.959		

- 1) Measured peak power spectrum density at difference data rate for each mode and recorded worst case for each mode.
- 2) Test results including cable loss;
- 3) Worst case data at 1Mbps at IEEE 802.11b; 6Mbps at IEEE 802.11g; 6.5Mbps at IEEE 802.11n HT20; 13.5Mbps at IEEE 802.11n HT40.

802.11b

802.11g

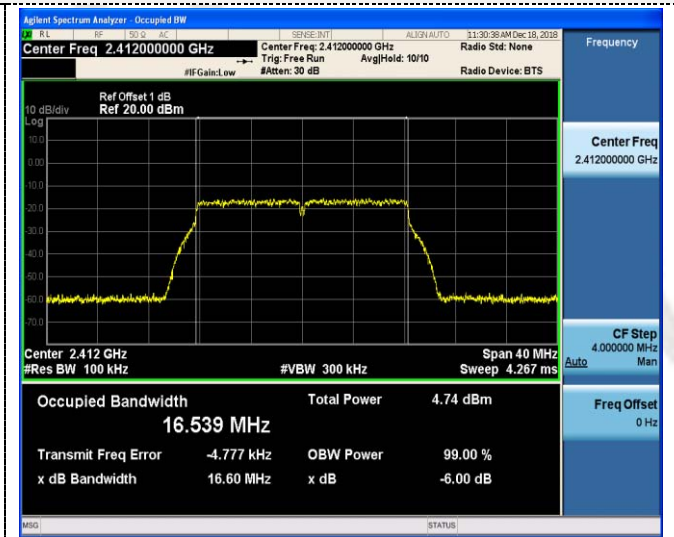

CH01

CH01

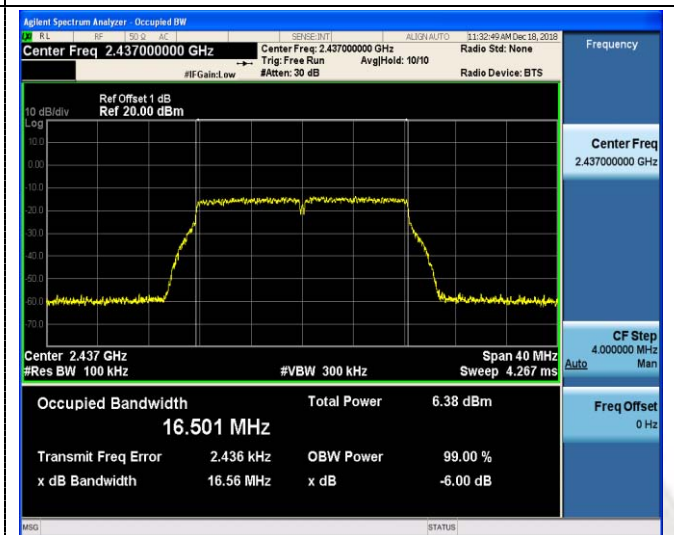
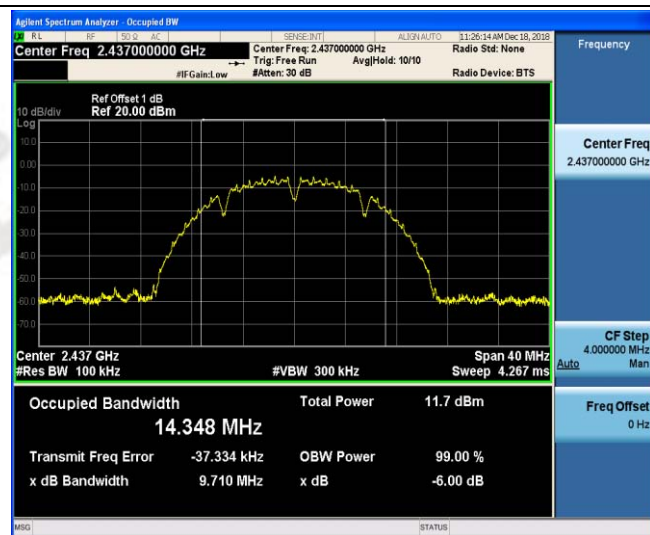

CH06

CH06

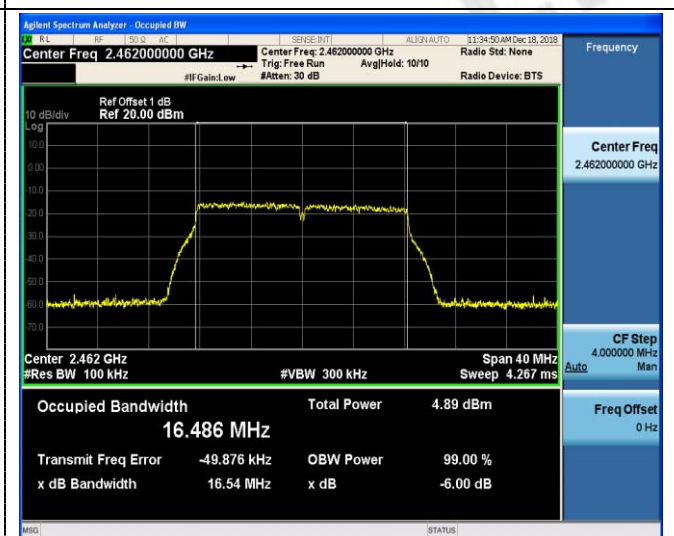
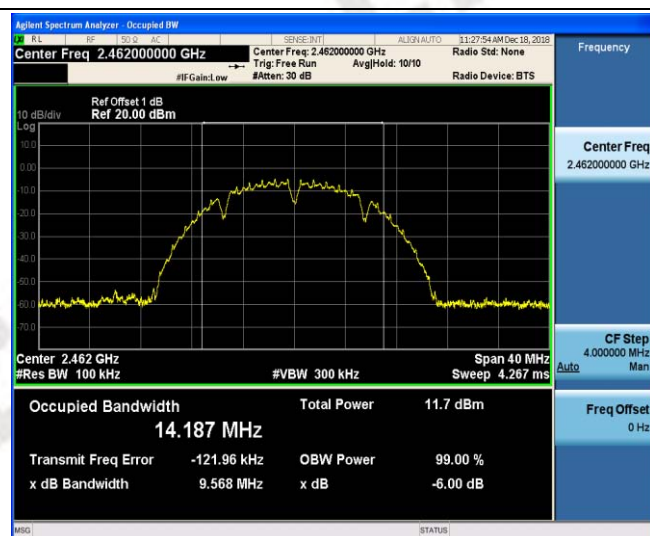

CH11

CH11

802.11n(HT20)

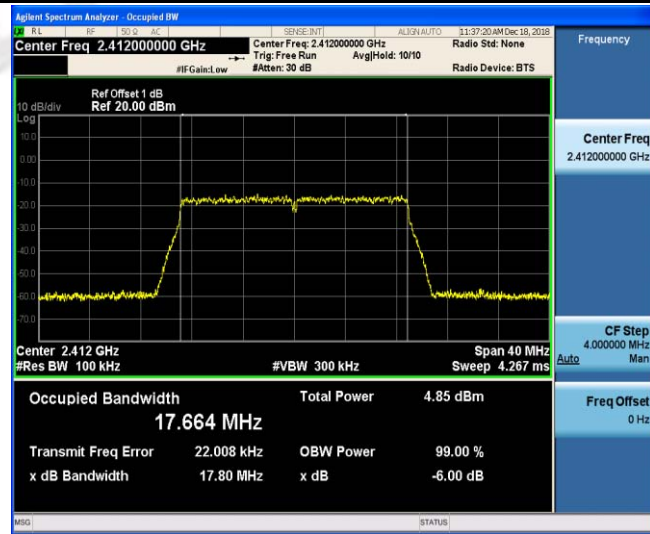

802.11n(HT40)

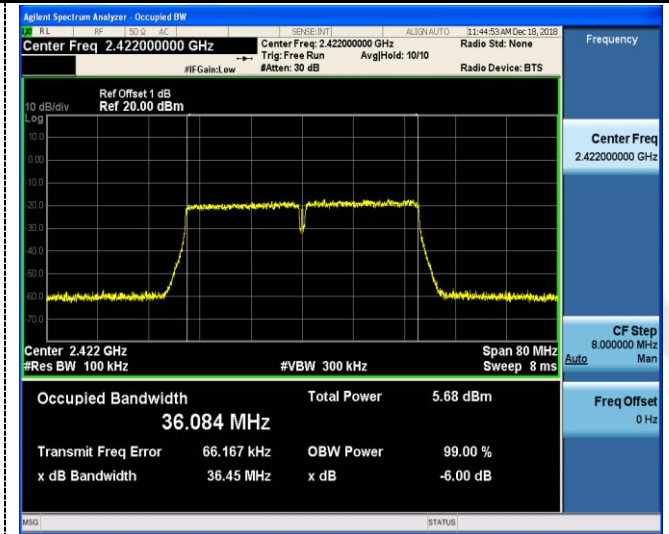

CH01

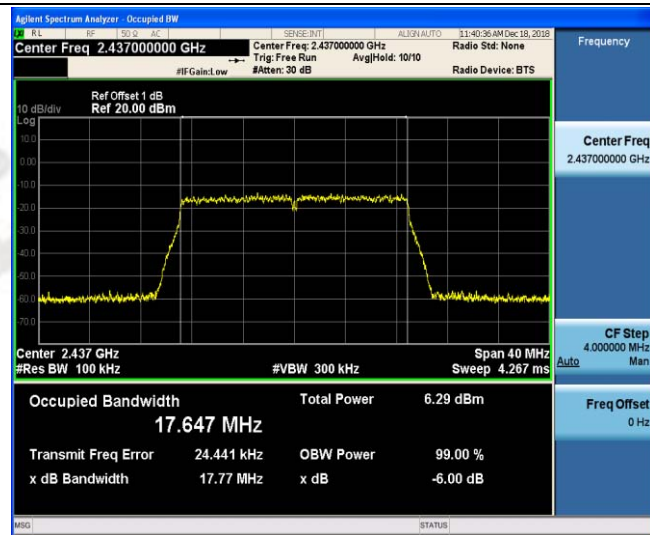

CH03

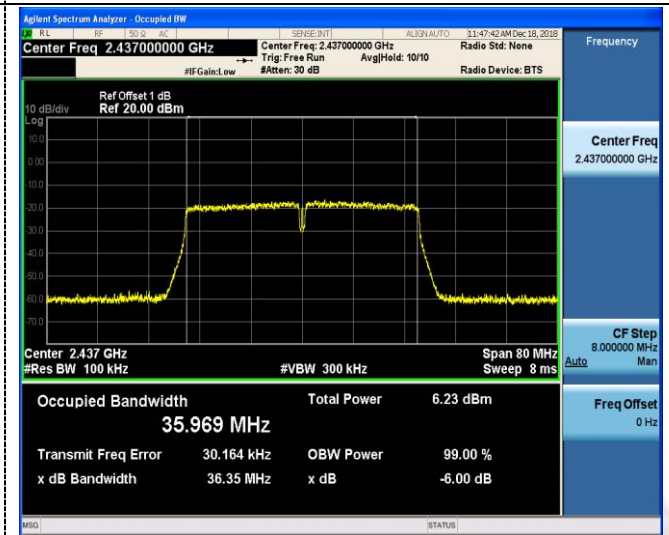

CH06

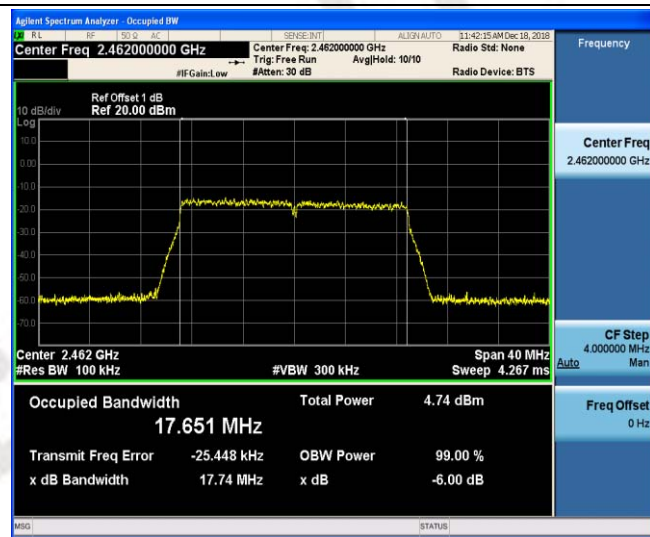

CH06

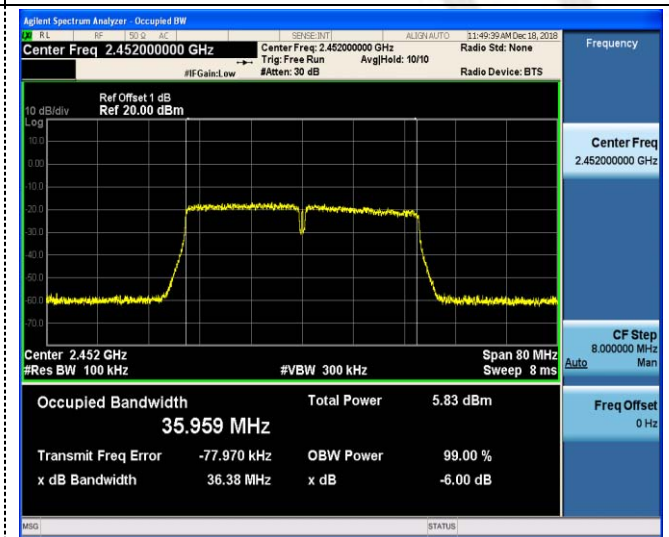

CH11

CH09

3.6. Out-of-band Emissions

Limit

In any 100 kHz bandwidth outside the frequency band in which the spread spectrum or digitally modulated intentional radiator is operating, the radio frequency power that is produced by the intentional radiator shall be at least 20 dB below that in the 100 kHz bandwidth within the band that contains the highest level of the desired power, based on either an RF conducted or a radiated measurement, provided the transmitter demonstrates compliance with the peak conducted power limits. If the transmitter complies with the conducted power limits based on the use of RMS averaging over a time interval, as permitted under paragraph (b)(3) of this section, the attenuation required under this paragraph shall be 30 dB instead of 20 dB. Attenuation below the general limits specified in §15.209(a) is not required.

Test Procedure

Connect the transmitter output to spectrum analyzer using a low loss RF cable, and set the spectrum analyzer to RBW=100 kHz, VBW= 300 kHz, peak detector, and max hold. Measurements utilizing these settings are made of the in-band reference level, bandedge and out-of-band emissions.

Test Configuration

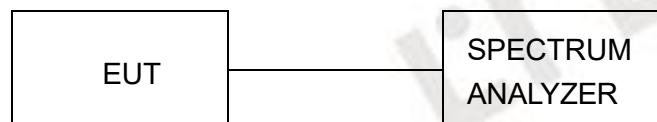

Test Results

Remark: The measurement frequency range is from 30MHz to the 10th harmonic of the fundamental frequency. The lowest, middle and highest channels are tested to verify the spurious emissions and bandedge measurement data.

Test plot as follows:

802.11b CH01



802.11b CH06

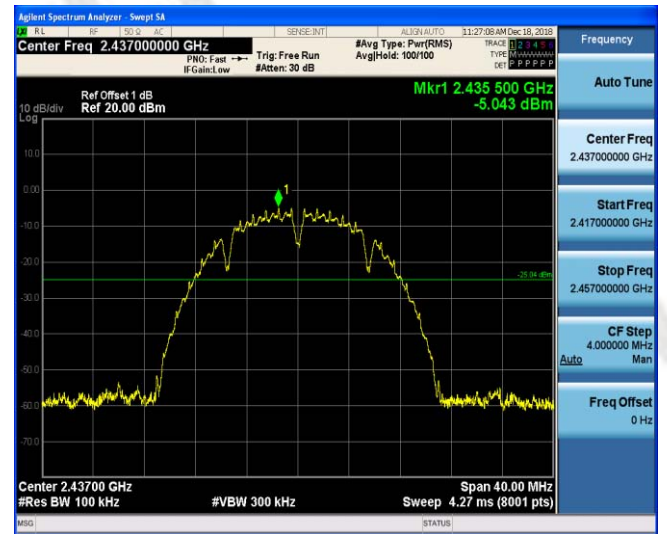

Reference

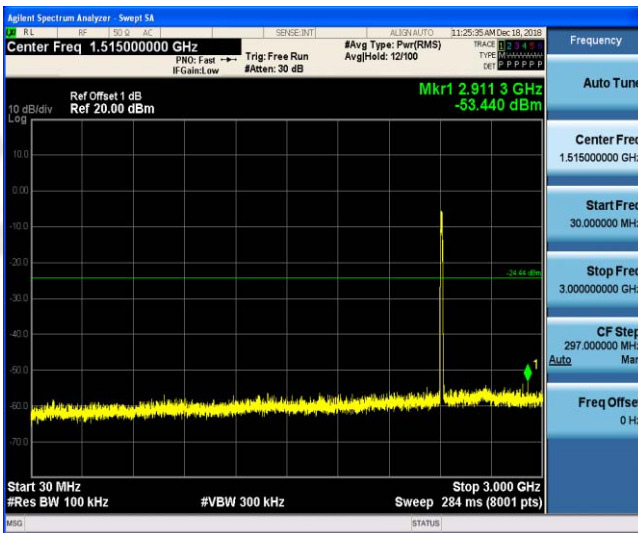

30MHz-3GHz

30MHz-3GHz



3GHz-25GHz

3GHz-25GHz

802.11b CH11

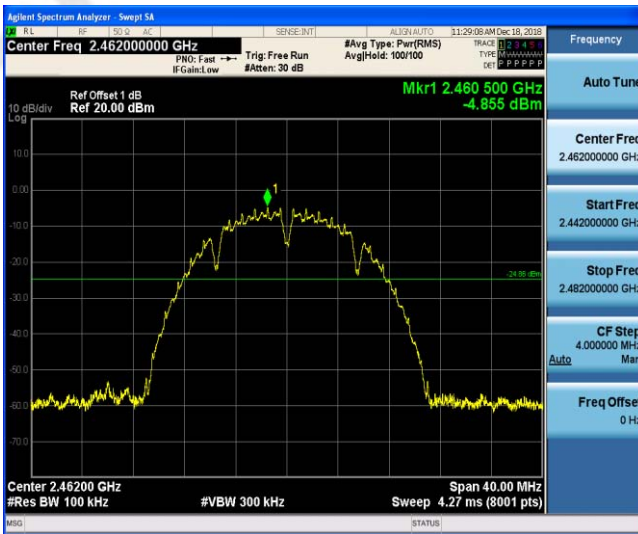

802.11g CH01

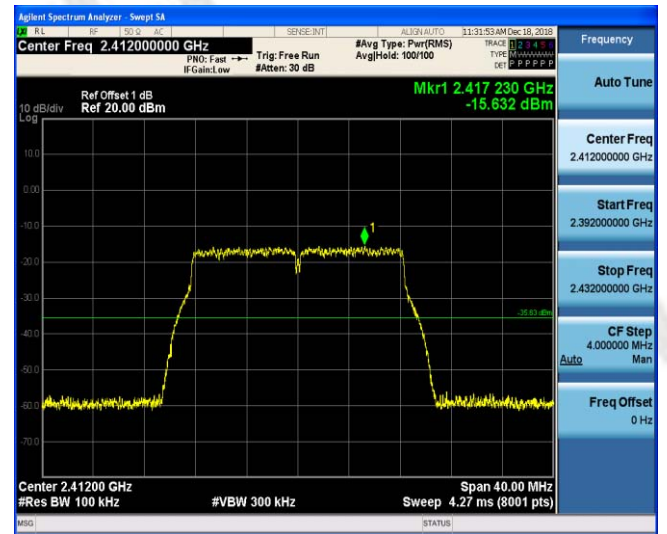

Reference

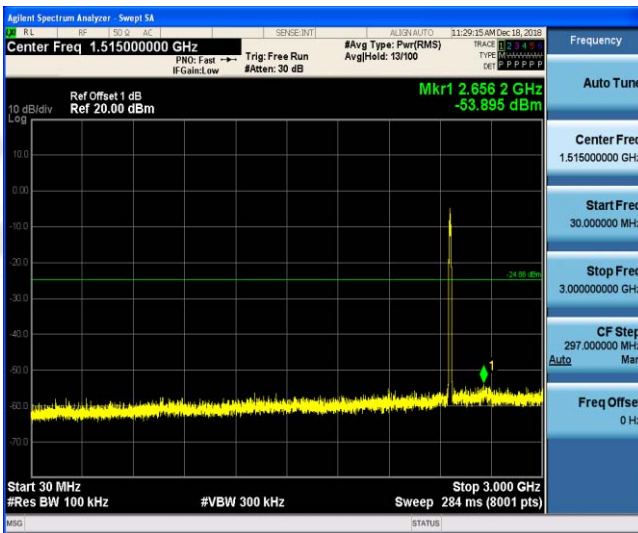

Reference

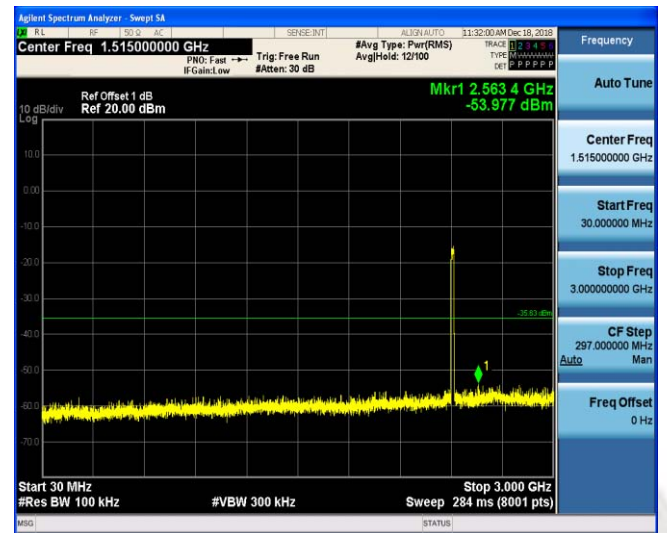

30MHz-3GHz



30MHz-3GHz

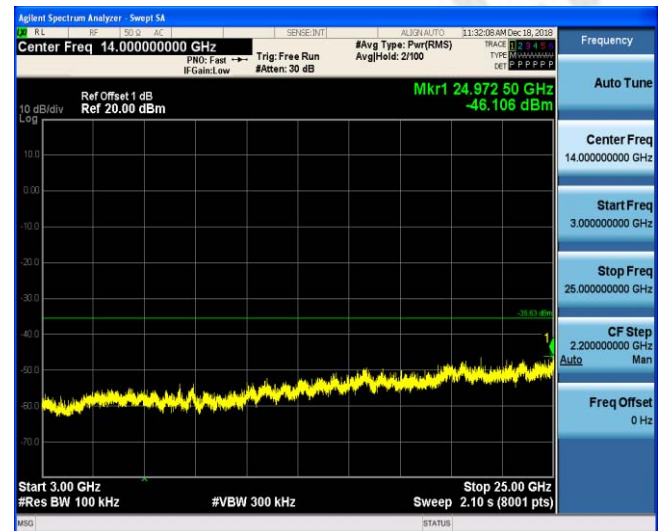

3GHz-25GHz

3GHz-25GHz

802.11g CH06

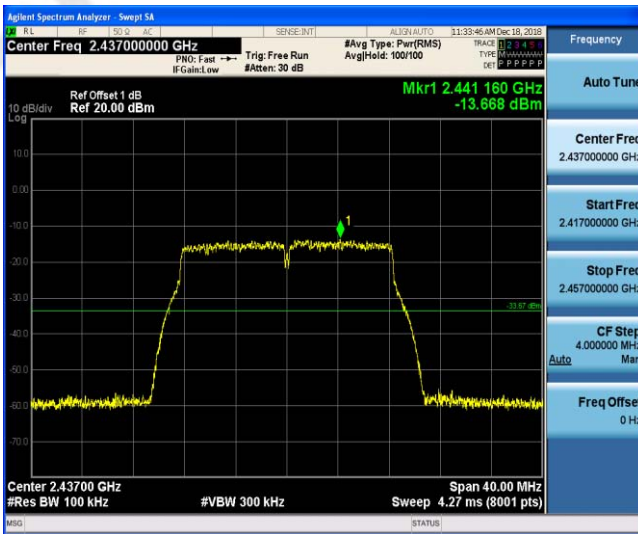

802.11g CH11

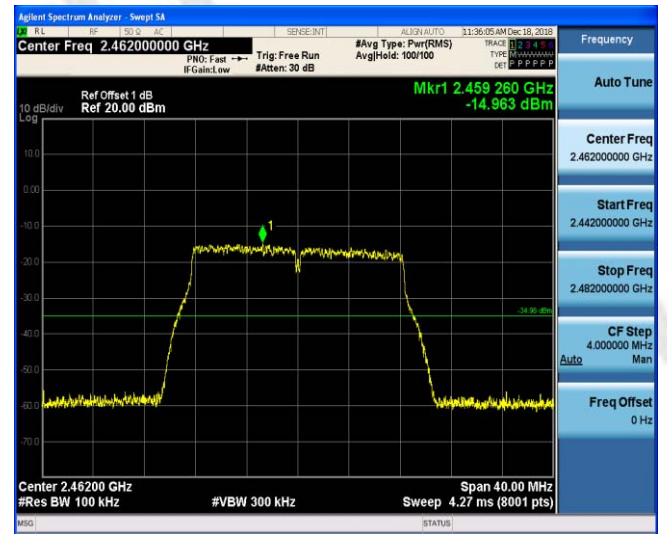

Reference

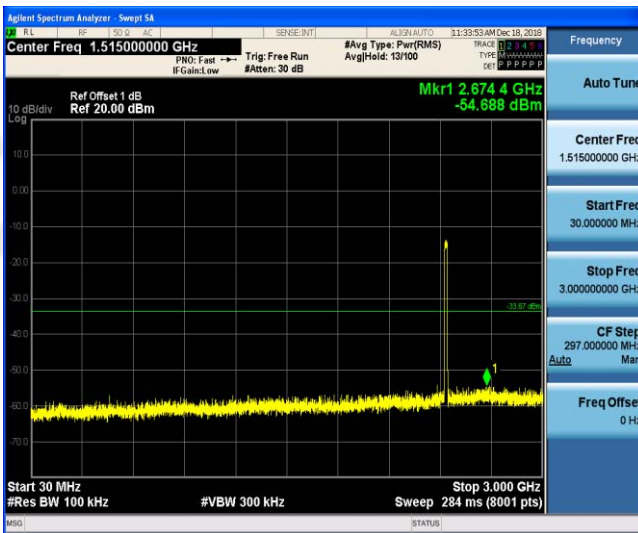

Reference

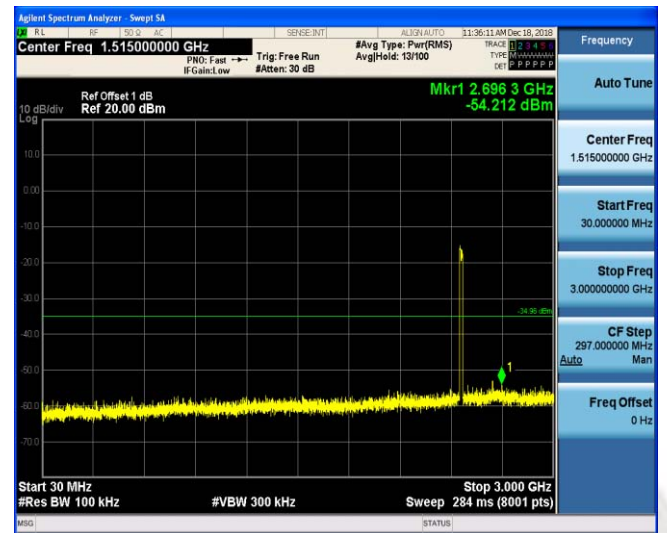

30MHz-3GHz

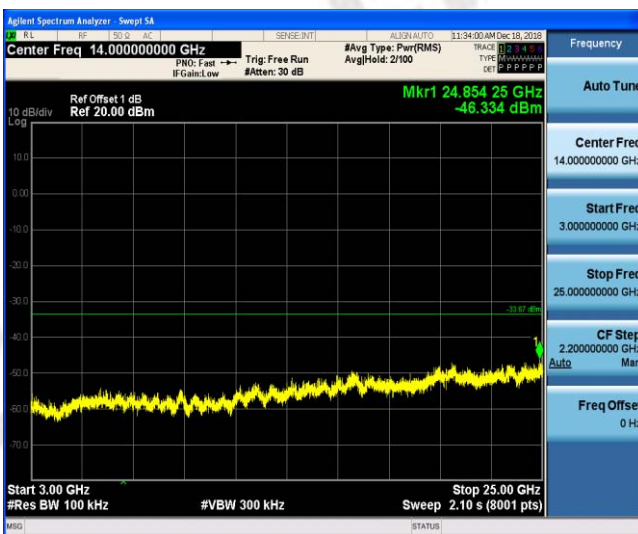

30MHz-3GHz



3GHz-25GHz

3GHz-25GHz

802.11n(HT20) CH01

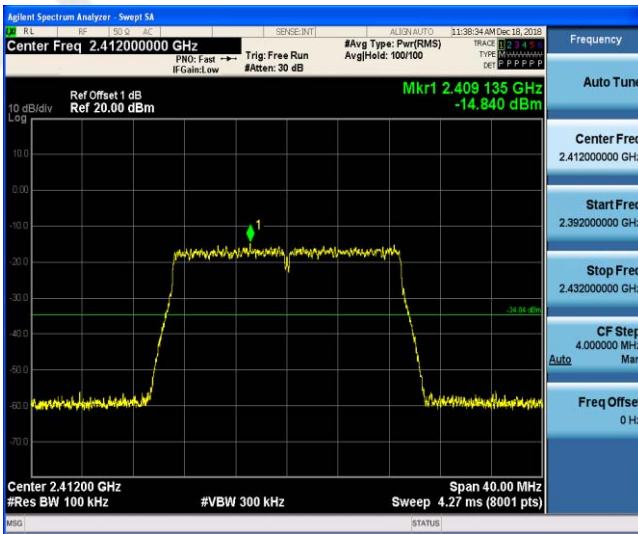

802.11n(HT20) CH06

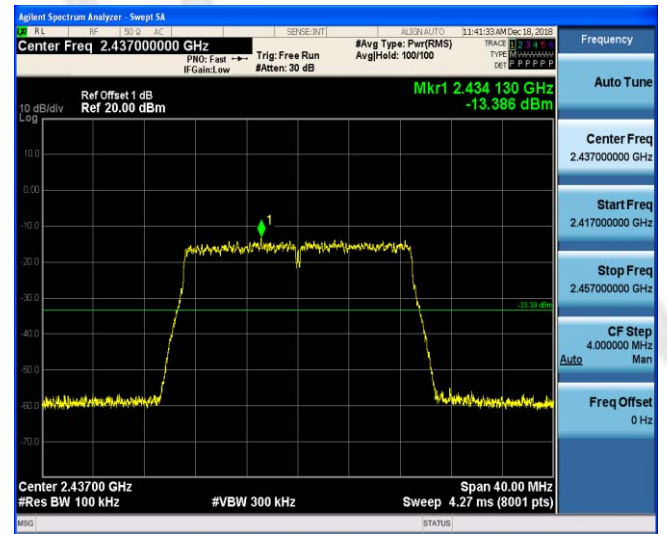

Reference

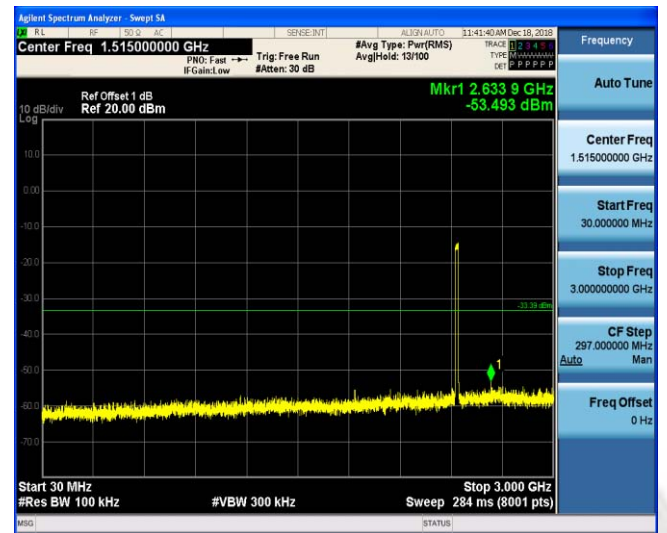
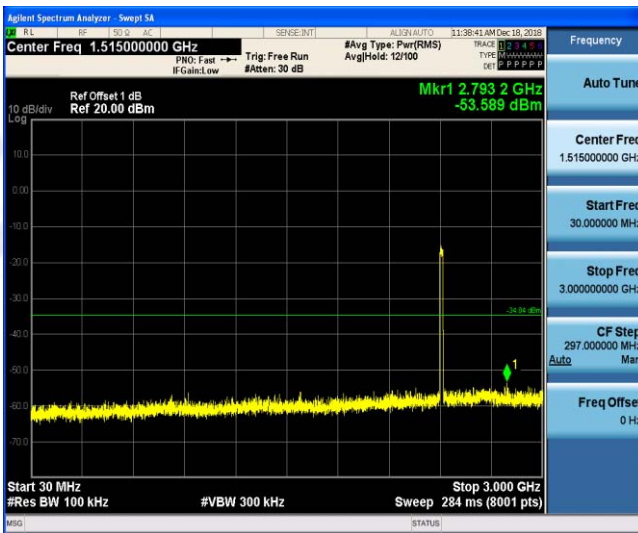

30MHz-3GHz

30MHz-3GHz

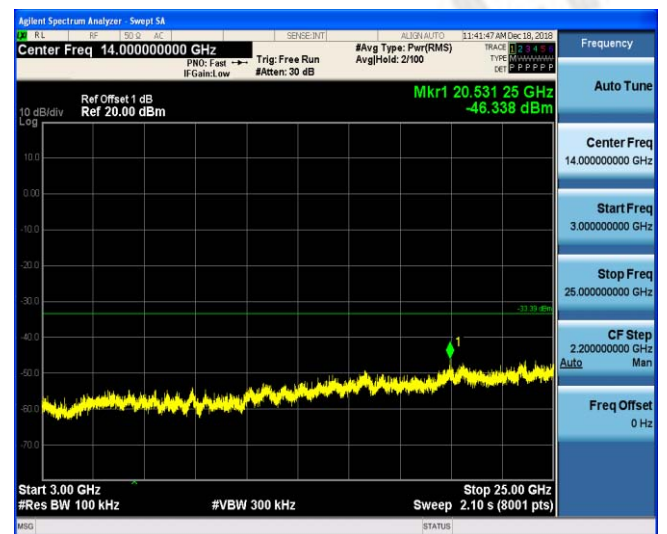
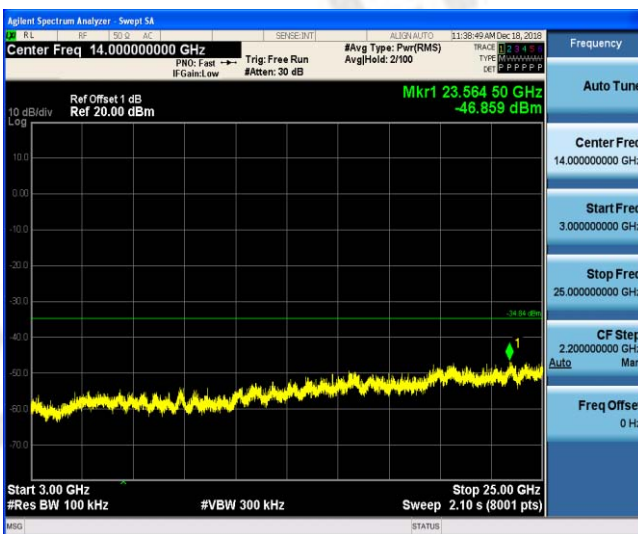

3GHz-25GHz

3GHz-25GHz

802.11n(HT20) CH11

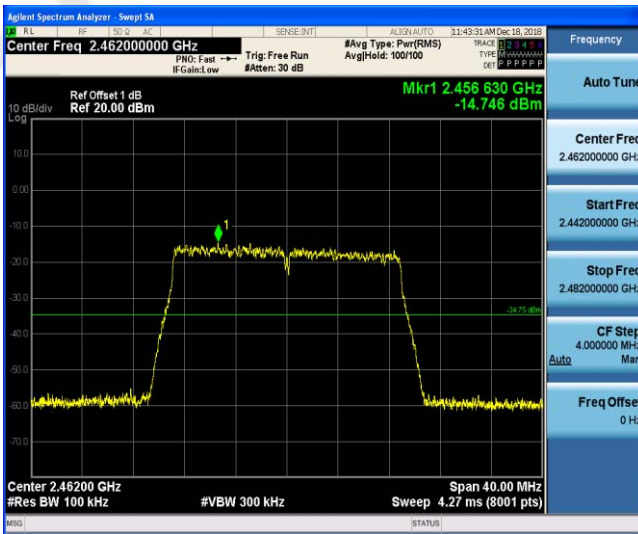

802.11n(HT40) CH03

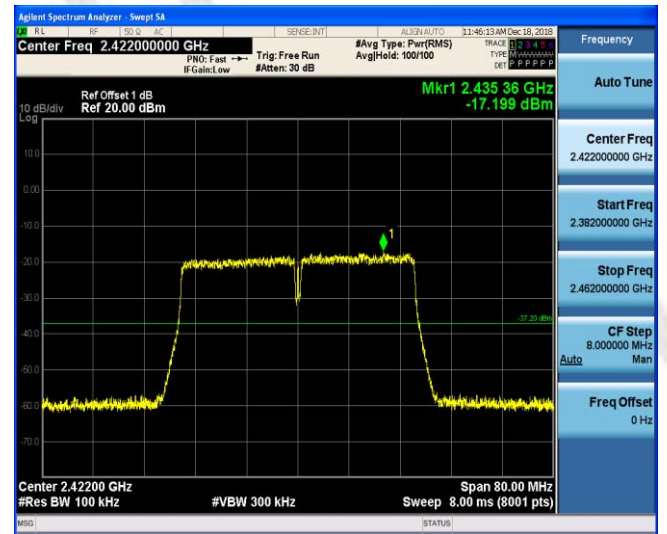

Reference

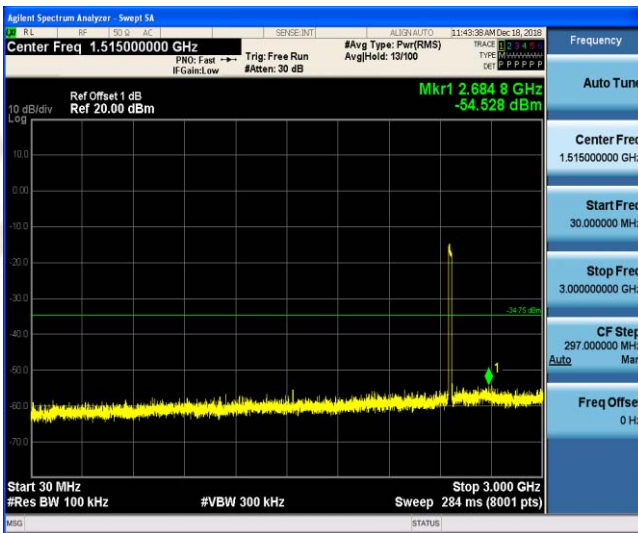

Reference

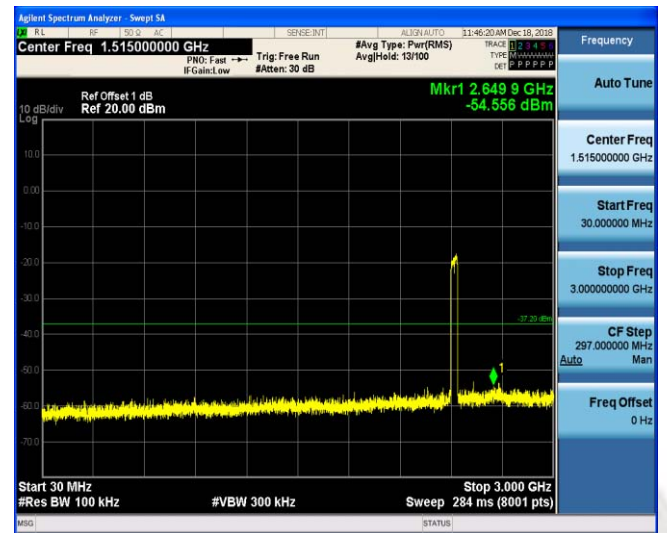

30MHz-3GHz

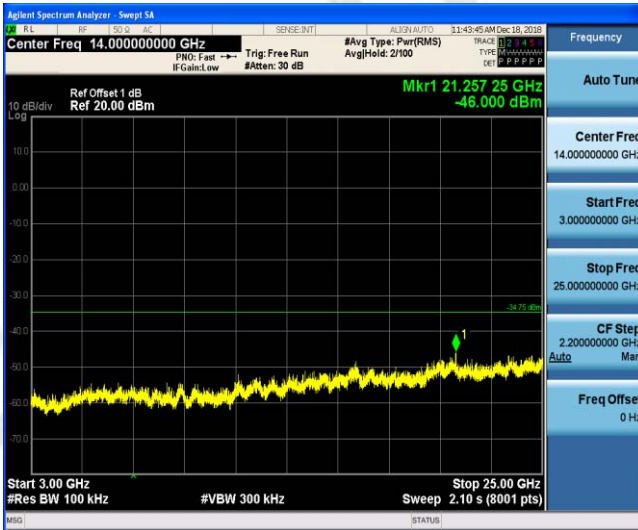

30MHz-3GHz



3GHz-25GHz

3GHz-25GHz

802.11n(HT40) CH06

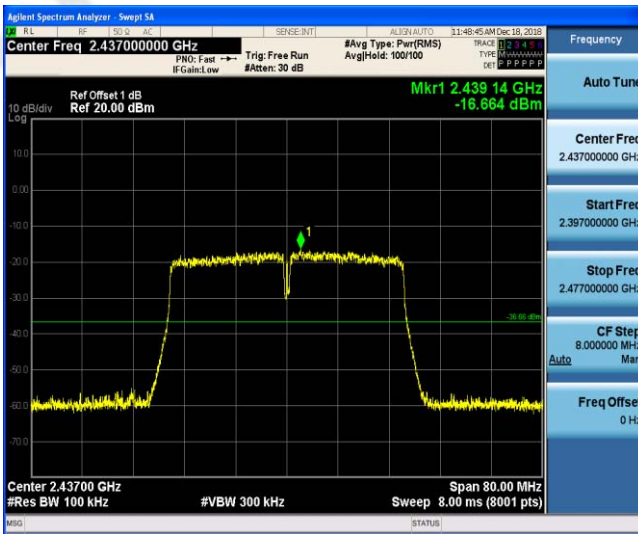

802.11n(HT40) CH09

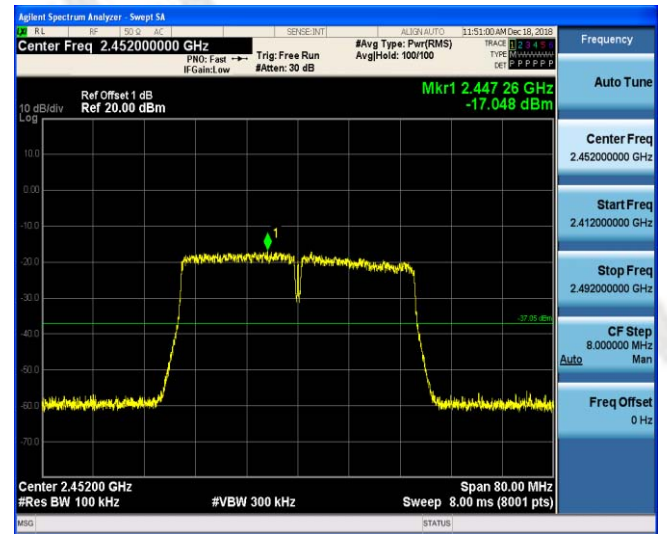

Reference

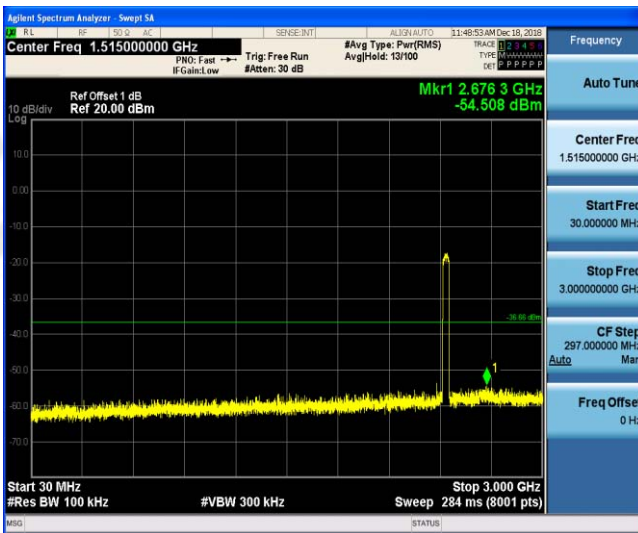

Reference

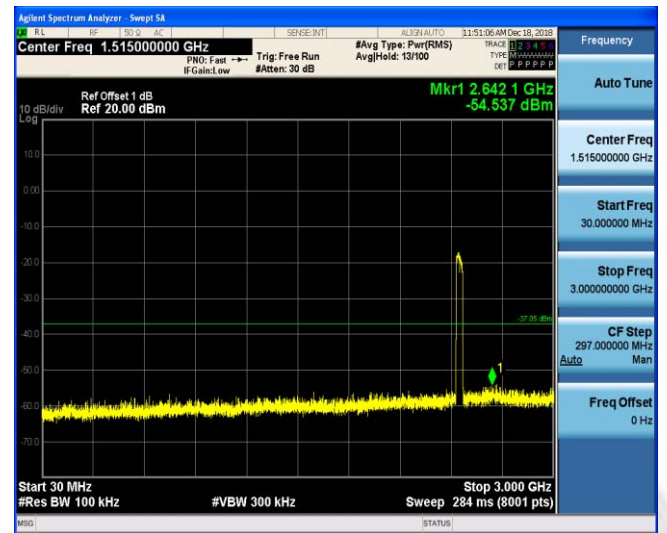

30MHz-3GHz



30MHz-3GHz



3GHz-25GHz

3GHz-25GHz

Band-edge Measurements for RF Conducted Emissions:

802.11b

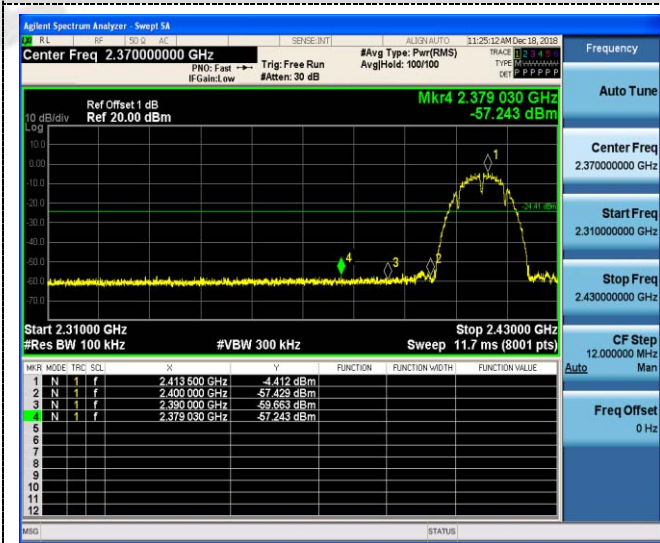

Left bandedge

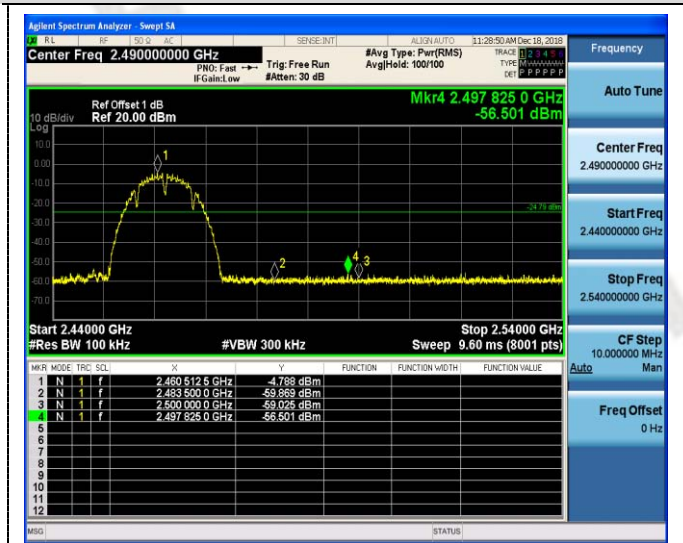

Right bandedge

802.11g

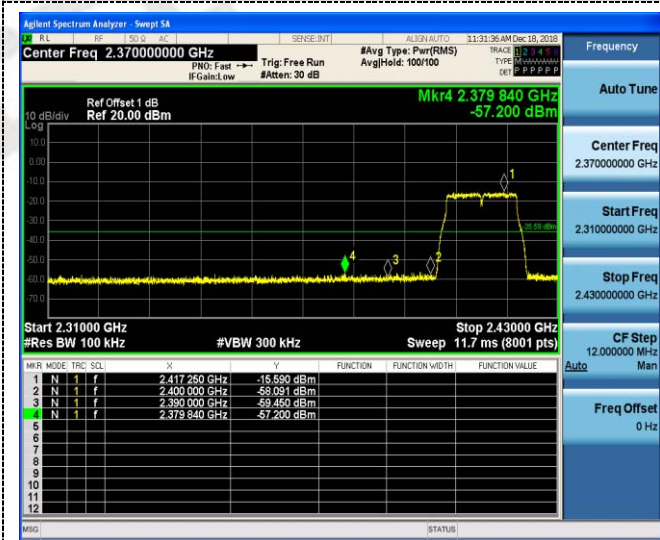

Left bandedge

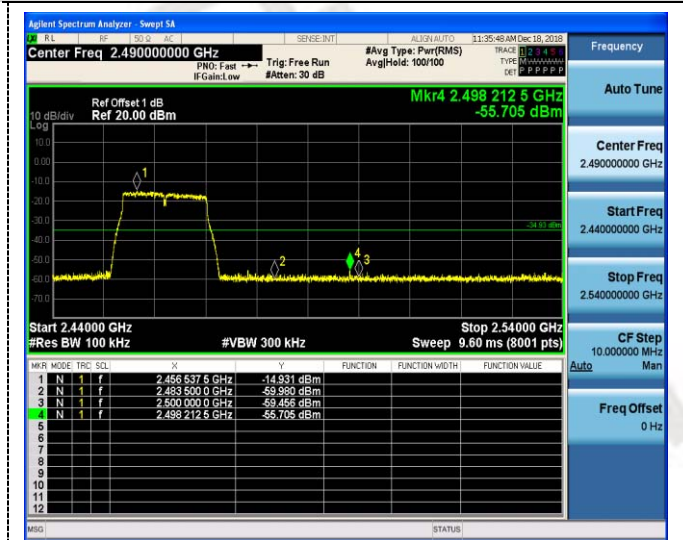

Right bandedge

802.11n(HT20)

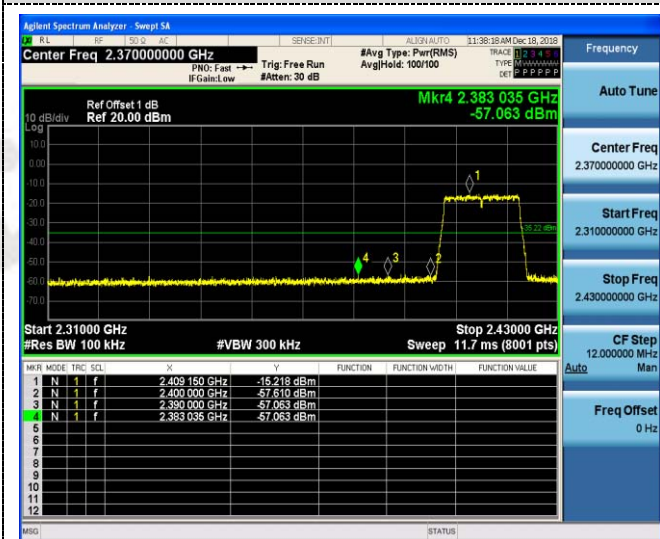

Left bandedge

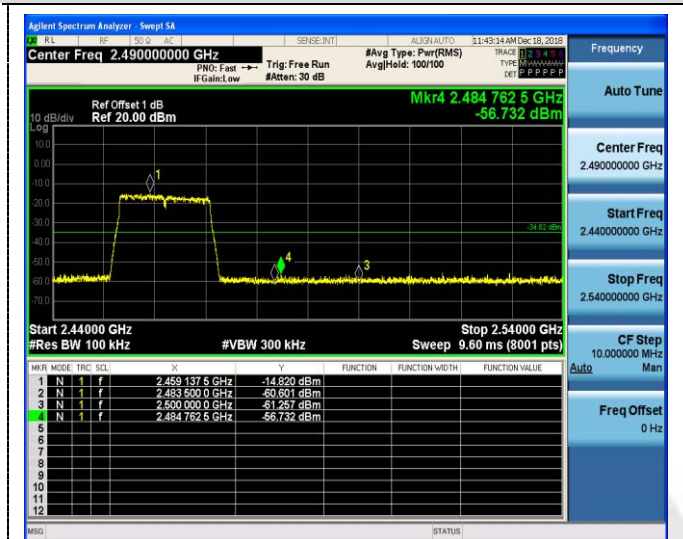

Right bandedge

802.11n(HT40)

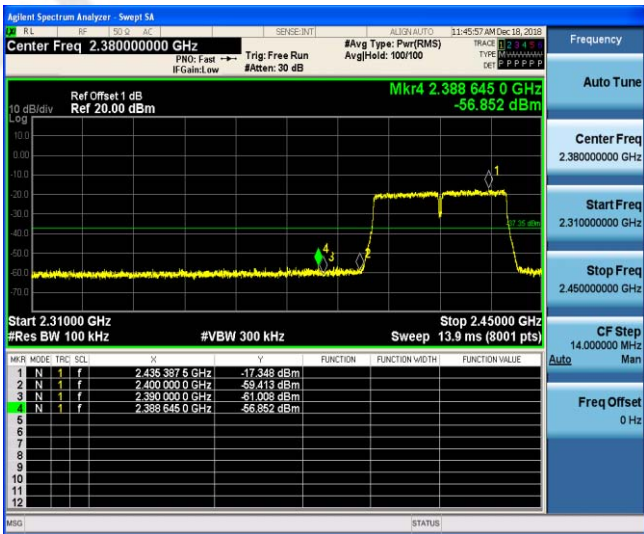

Left bandedge

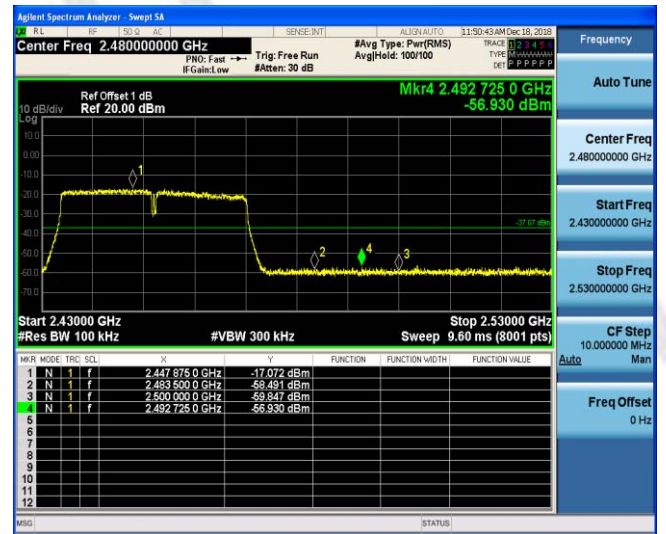

Right bandedge

3.7. Antenna Requirement

Standard Applicable

For intentional device, according to FCC 47 CFR Section 15.203:

An intentional radiator shall be designed to ensure that no antenna other than that furnished by the responsible party shall be used with the device. The use of a permanently attached antenna or of an antenna that uses a unique coupling to the intentional radiator, the manufacturer may design the unit so that a broken antenna can be replaced by the user, but the use of a standard antenna jack or electrical connector is prohibited

FCC CFR Title 47 Part 15 Subpart C Section 15.247(c) (1) (I):

(i) Systems operating in the 2400-2483.5 MHz band that is used exclusively for fixed. Point-to-point operations may employ transmitting antennas with directional gain greater than 6dBi provided the maximum conducted output power of the intentional radiator is reduced by 1 dB for every 3 dB that the directional gain of the antenna exceeds 6dBi.

Test Result:

The maximum gain of antenna was 0.5dBi.

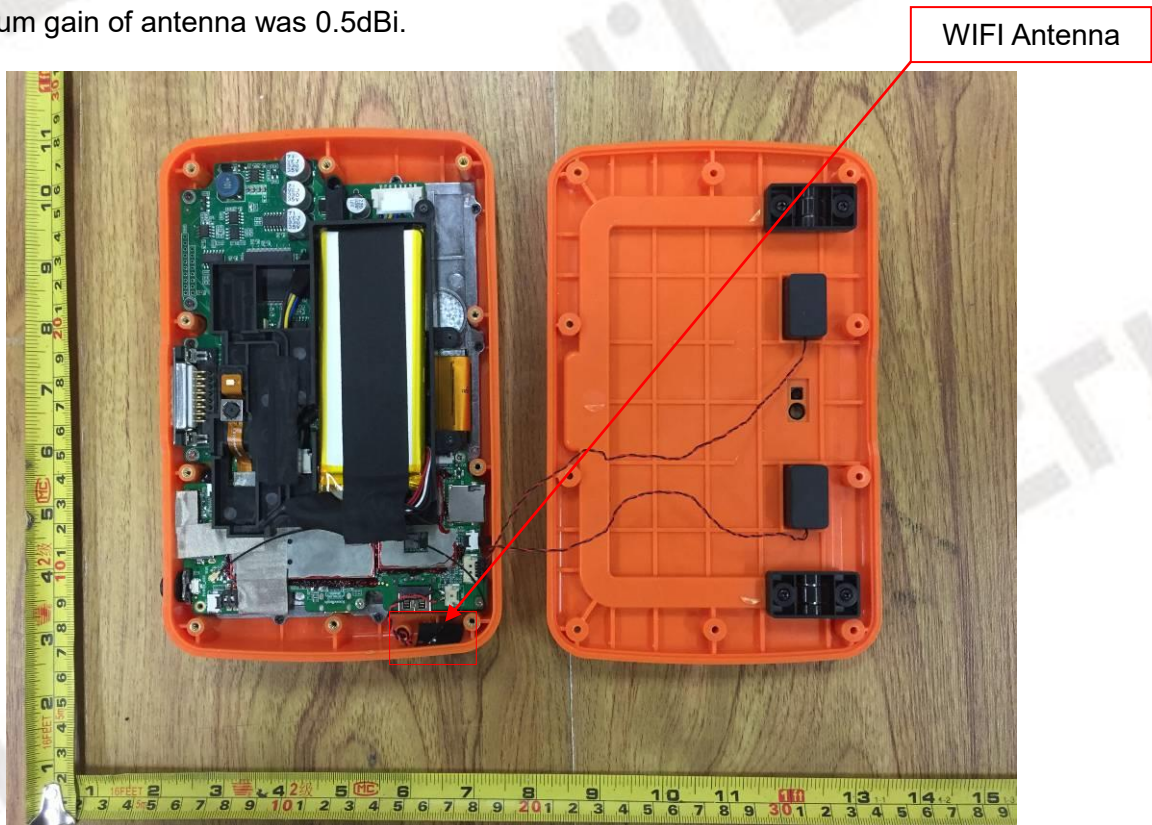

4. Test Setup Photos of the EUT

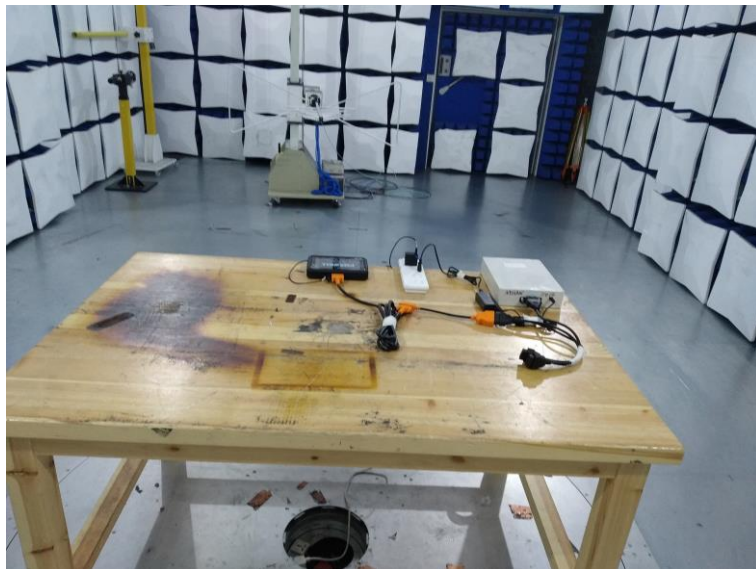

5. Photos of the EUT

Reference to the test report No. CTL1811201051-WF01

***** End of Report *****