





TEST REPORT

<p>KCTL Inc. 65, Sinwon-ro, Yeongtong-gu, Suwon-si, Gyeonggi-do, 16677, Korea TEL: 82-31-285-0894 FAX: 82-505-299-8311 www.kctl.co.kr</p>	<p>Report No.: KR19-SEF0016 Page (1) of (30)</p>	
<p>1. Client</p> <ul style="list-style-type: none"> ◦ Name : HANBITEDS.CO.,LTD ◦ Address : 44-10, Techno 10-ro, Yuseong-gu, Daejeon, Republic of Korea ◦ Date of Receipt : 2019-01-09 <p>2. Use of Report : -</p> <p>3. Name of Product and Model : SENSOR NODE : GT1L-W / HB-USP-GT1L-W</p> <p>4. Manufacturer and Country of Origin : HANBITEDS.CO.,LTD / Korea</p> <p>5. Date of Test : 2019-01-20 to 2019-01-22</p> <p>6. Test method used : ANSI C63.4:2014, Class A</p> <p>7. Test Results : Refer to the test result in the test report</p>		
<p>Affirmation</p>	<p>Tested by  Name : Gueseok Lee (Signature)</p>	<p>Technical Manager  Name : Gunsu Park (Signature)</p>
<p>2019-01-31</p>		
<p>KCTL Inc.</p>		
<p>As a test result of the sample which was submitted from the client, this report does not guarantee the whole product quality. This test report should not be used and copied without a written agreement by KCTL Inc.</p>		

REPORT REVISION HISTORY

Date	Revision	Page No
2019-01-31	Originally issued	-

This report shall not be reproduced except in full, without the written approval of KCTL Inc. This document may be altered or revised by KCTL Inc. personnel only, and shall be noted in the revision section of the document. Any alteration of this document not carried out by KCTL Inc. will constitute fraud and shall nullify the document.



Contents

1. Applicant information	4
2. Laboratory information	5
3. Test system configuration	6
3.1 Operation environment.....	6
3.2 Measurement Uncertainty	7
4. Description of EUT	9
4.1 General information.....	9
4.2 Product description.....	10
4.3 Auxiliary equipments	10
4.4 Test configuration	11
4.5 Operating conditions	12
5. Summary of test results	13
5.1 Summary of EMI emission test results.....	13
6. Test results	14
6.1 Conducted Emissions.....	14
6.2 Radiated Emission	18
7. EUT photographs	25

KCTL Inc.

65, Sinwon-ro, Yeongtong-gu,
Suwon-si, Gyeonggi-do, 16677, Korea
TEL: 82-31-285-0894 FAX: 82-505-299-8311
www.kctl.co.kr

Report No.:
KR19-SEF0016

Page (4) of (30)



1. Applicant information

Applicant: HANBITEDS.CO.,LTD
Address: 44-10, Techno 10-ro, Yuseong-gu, Daejeon, Republic of Korea
Telephone: +82-42-862-5882
Fax: +82-42-932-9624
E-mail: 03kkh259@hanbiteds.co.kr
Contact name: Kwanghyeon Kim

Manufacturer: HANBITEDS.CO.,LTD
Address: 44-10, Techno 10-ro, Yuseong-gu, Daejeon, Republic of Korea
Telephone: +82-42-862-5882
Fax: +82-42-932-9624
E-mail: 03kkh259@hanbiteds.co.kr
Contact name: Kwanghyeon Kim



KCTL Inc.

65, Sinwon-ro, Yeongtong-gu,
Suwon-si, Gyeonggi-do, 16677, Korea
TEL: 82-31-285-0894 FAX: 82-505-299-8311
www.kctl.co.kr

Report No.:
KR19-SEF0016

Page (5) of (30)

KCTL

2. Laboratory information

Address

KCTL Inc. (Suwon Lab.)

65, Sinwon-ro, Yeongtong-gu, Suwon-si, Gyeonggi-do, 16677, Korea

Telephone Number: 82 31 285 0894

Facsimile Number: 82 505 299 8311

FCC Site Designation No: KR0040

VCCI Registration No. : R-3327, G-198, C-3706, T-1849

Industry Canada Registration No. : 8035A

KOLAS NO.: KT231

SITE MAP



3. Test system configuration

3.1 Operation environment

	Temperature	Humidity	Pressure
Chamber 10 m (RE)	22.3 °C / 22.4 °C	13.6 % R.H. / 18.1 % R.H.	-
Shielded room(CE)	21.3 °C	14.5 % R.H.	-

Test site

These testing items were performed following locations;

Test item	Test site
Conducted Emission	Shielded Room
Radiated Emission	10 m Chamber

KCTL Inc.

65, Sinwon-ro, Yeongtong-gu,
Suwon-si, Gyeonggi-do, 16677, Korea
TEL: 82-31-285-0894 FAX: 82-505-299-8311
www.kctl.co.kr

Report No.:
KR19-SEF0016

Page (7) of (30)



3.2 Measurement Uncertainty

All measurements involve certain levels of uncertainties, especially in field of EMC.

The factors contributing to uncertainties are test receiver, cable loss, antenna factor calibration, Antenna directivity, antenna factor variation with height, antenna phase center variation, antenna frequency interpolation, measurement distance variation, site imperfection, mismatch, and system repeatability. Based on CISPR 16-4-2, the measurement uncertainty level with a 95 % confidence level was applied.

Conducted Emission measurement (Confidence level about 95 %, $k = 2$)		
Shielded Room (CE#1)	9 kHz ~ 150 kHz:	3.42 dB
	150 kHz ~ 30 MHz:	3.16 dB
Shielded Room (CE#2)	9 kHz ~ 150 kHz:	3.14 dB
	150 kHz ~ 30 MHz:	3.12 dB
Radiated Emission measurement (Confidence level about 95 %, $k = 2$)		
10 m Chamber (4F)	30 MHz ~ 300 MHz	3 m: 5.04 dB
		10 m: 5.02 dB
	300 MHz ~ 1 000 MHz	3 m: 5.08 dB
		10 m: 5.02 dB
	1 GHz ~ 6 GHz	3 m: 6.42 dB
	6 GHz ~ 18 GHz	3 m: 6.64 dB
18 GHz ~ 40 GHz	3 m: 6.24 dB	
10 m Chamber (2F)	30 MHz ~ 300 MHz	3 m: 5.56 dB
		10 m: 5.50 dB
	300 MHz ~ 1 000 MHz	3 m: 5.58 dB
		10 m: 5.46 dB
	1 GHz ~ 6 GHz	3 m: 6.30 dB
	6 GHz ~ 18 GHz	3 m: 6.74 dB
3 m Chamber (3F)	30 MHz ~ 300 MHz	3 m: 5.00 dB
	300 MHz ~ 1 000 MHz	3 m: 5.02 dB
	1 GHz ~ 6 GHz	3 m: 6.44 dB
	6 GHz ~ 18 GHz	3 m: 6.26 dB

3.3 Measurement Program

These test items were performed by software programs;

Test item	Measurement Program		Used
Conducted Emission	EP5CE_V 5.4.0(TOYO)		☒
Radiated Emission	2F	EP5RE_V 4.6.0(TOYO)	☒
	4F	EP5RE_V 5.11.10(TOYO)	



KCTL Inc.

65, Sinwon-ro, Yeongtong-gu,
Suwon-si, Gyeonggi-do, 16677, Korea
TEL: 82-31-285-0894 FAX: 82-505-299-8311
www.kctl.co.kr

Report No.:
KR19-SEF0016

Page (9) of (30)

KCTL

4. Description of EUT

4.1 General information

Hardware			
Microprocessor	STM32L051 (32bit, ARM cortex-M0)		
Memory	64Kbyte program memory		
	8KByte SRAM		
Clock Speed	32MHz		
RF	WiFi		
Serial	RS-485		
RF Interface			
Protocol	Light Weight TCP/IP		
Communication Speed	921,600 bps		
Communication Distance	10m		
Frequency Range	2,400MHz ~ 2,483.5MHz		
Transmission Power	14dBm(Typical)		
Antenna	Helical, 2.85 dBi, SMA type		
Analog Sensor Input (CH1 ~ CH4)			
Sensor Input Type	DC voltage	DC current	Resistive
Number of Channels	4	4	4
ADC Resolution	12bit		
Sampling Cycle	7.68kSPS (sample per second)		
Input Range	DC 0~5V	DC 4~20mA	0~20kΩ
Analog Sensor Power Supply			
Voltage	DC 5V		
Power and Environment			
Input Voltage Range	4.8V ~ 5.2V		
Operation Temperature	-20 °C ~ 60 °C		
Storage Temperature	-30 °C ~ 70 °C		
Case Materials	ABS (Acrylnitrile-Butadiene-Styrene)		
Weight	120 g		
Dimension	55 x 80 x 30 mm (W x H x D), except RF antenna		

* The Battery is not replaceable.

4.2 Product description

Type of product	SENSOR NODE : GT1L-W
Model name (Basic)	HB-USP-GT1L-W
Model name (Variant)	-
Difference	-
Serial no	-
FCC ID	2ASBKHB-USP-GT1L-W
Testing voltage	120 V, 60 Hz
Input/Output rating	Adapter (RS-400/500-S325) Input: AC 100 V - 240 V, 50/60 Hz, 1.2 A Output: DC 5 V, 4 A
Internal clock frequency	Above 108 MHz
Note	-The following accessories were provided by the manufacturer. 1) Adapter 2) Dipole ANT -RS485, USB, DS1 Port is not tested with the administrator port.

4.3 Auxiliary equipments

Type	Model / Part #	S/N	Manufacturer
Temperature Sensor	-	-	HANBITEDS.CO.,LTD
SINK NODE : GT2-W	HB-USP-GT2-W	-	HANBITEDS.CO.,LTD
Adapter #1	RS-400/500-S325	-	SHENZHEN JINHUASHENG POWER TECHNOLOGY CO.,LTD
Note PC	HP ProBook 470 G2	CND5074WT	HP
Adapter #2	PPP009C	F220881440034736	HP
Dipole ANT	-	-	-

KCTL Inc.

65, Sinwon-ro, Yeongtong-gu,
Suwon-si, Gyeonggi-do, 16677, Korea
TEL: 82-31-285-0894 FAX: 82-505-299-8311
www.kctl.co.kr

Report No.:
KR19-SEF0016

Page (11) of (30)

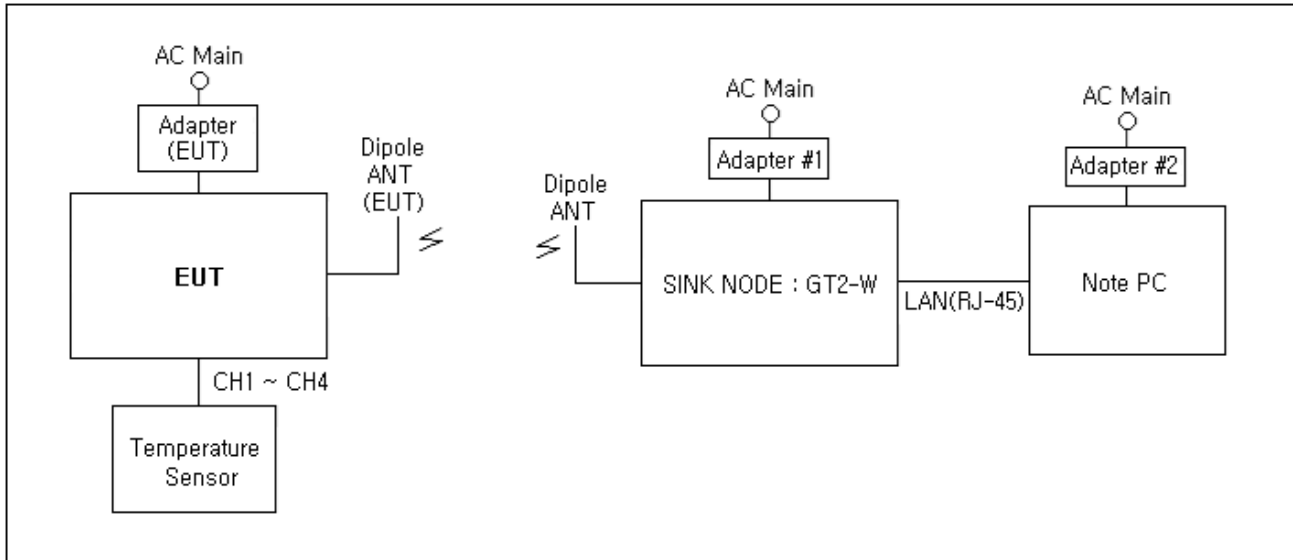
KCTL**4.4 Test configuration**

	Start		End		Cable	
	Name	I/O port	Name	I/O port	Length (m)	Spec.
1	EUT	Power	Adapter (EUT)	-	1.8	Unshield
2		RF	Dipole ANT (EUT)	-	Direct	-
3		CH1 ~ CH4	Temperature Sensor	-	3.0	Unshield
4	Adapter (EUT)	Power	AC Main	-	1.5	Unshield
5	SINK NODE : GT2-B	Power	Adapter #1	-	1.8	Unshield
6		RF	Dipole ANT	-	Direct	-
7		LAN(RJ-45)	Note PC	LAN(RJ-45)	3.0	Unshield
8	Note PC	Power	Adapter #2	-	1.5	Unshield

This test report shall not be reproduced, except in full, without the written approval.

4.5 Operating conditions

The EUT was configured as normal intended use.

Test Mode	Normal operating
Test #1	Test using 'LDP' program on the Note PC to check the operation of the Temperature Sensor in the Wifi communication between EUT and SINK NODE : GT2-W.



5. Summary of test results

5.1 Summary of EMI emission test results

Applied	Test items	Test method	Result
<input checked="" type="checkbox"/>	Conducted Emission	ANSI C63.4:2014, Class A FCC Part 15 Subpart B	Pass
<input checked="" type="checkbox"/>	Radiated Emission	ANSI C63.4:2014, Class A FCC Part 15 Subpart B	Pass

These results are deemed satisfactory evidence of compliance with ICES-003 of the Canadian Interference-Causing Equipment Regulations.



6. Test results

6.1 Conducted Emissions

Test specification	ANSI C63.4:2014, Class A FCC Part 15 Subpart B		
Testing voltage	120 V, 60 Hz		
Test facility	Shielded room (CE#1)		
Date	2019-01-22		
Temperature (°C)	21.3 °C	Humidity (% R.H.)	14.5 % R.H.
Remarks	Pass		

6.1.1 Limits of conducted emissions measurement

Frequency [MHz]	Class A (dB(μ V))		Class B (dB(μ V))	
	Quasi-peak	Average	Quasi-peak	Average
0.15 ~ 0.5	79	66	66 ~ 56 ¹⁾	56 ~ 46 ¹⁾
0.5 ~ 5	73	60	56	46
5 ~ 30	73	60	60	50

¹⁾ The limit decreases linearly with the logarithm of frequency

6.1.2 Measurement procedure

The measurements were performed in a shielded room. EUT was setup as shown in photograph and placed on a non-metallic table height of 0.8 m above the reference ground plane. The rear of table was located 0.4 m to the vertical conducted plane. EUT was power through the LISN, which was bonded to the ground plane. The LISN power was filtered. Each EUT power lead, except ground (safety) lead was individually connected through a LISN to input power source. EUT signal cables that hung closer than 0.4 m to the Horizontal metal ground 0.3 m ~ 0.4 m long. The power cord was bundles in the center. All peripheral equipment was powered from a sub LISN. The LISN and ISN were positioned 0.8 m from the EUT. Peak and Average detection were used in preliminary testing and Quasi-peak and Average detections were used at final measurement.

6.1.3 Used equipments

Equipment	Model no.	Serial no.	Makers	Next Cal. Date	Used
EMI TEST RECEIVER	ESCI	100001	R&S	2019.08.23	☒
TWO-LINE V-NETWORK	ENV216	101358	R&S	2019.04.05	☒
TWO-LINE V-NETWORK	ENV216	101352	R&S	2019.05.24	☒

KCTL Inc.

65, Sinwon-ro, Yeongtong-gu,
Suwon-si, Gyeonggi-do, 16677, Korea
TEL: 82-31-285-0894 FAX: 82-505-299-8311
www.kctl.co.kr

Report No.:
KR19-SEF0016
Page (16) of (30)



6.1.4 Photographs of test setup

AC Main

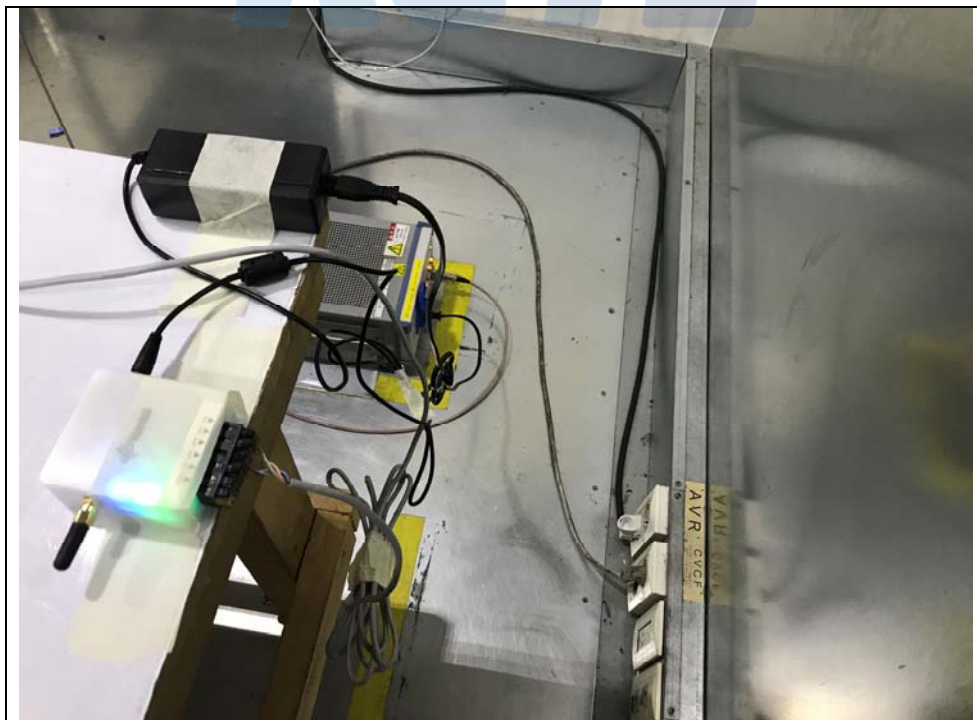

KCTL Inc.

65, Sinwon-ro, Yeongtong-gu,
Suwon-si, Gyeonggi-do, 16677, Korea
TEL: 82-31-285-0894 FAX: 82-505-299-8311
www.kctl.co.kr

Report No.:
KR19-SEF0016

Page (17) of (30)



6.1.5 Conducted emissions measurement result

AC Main

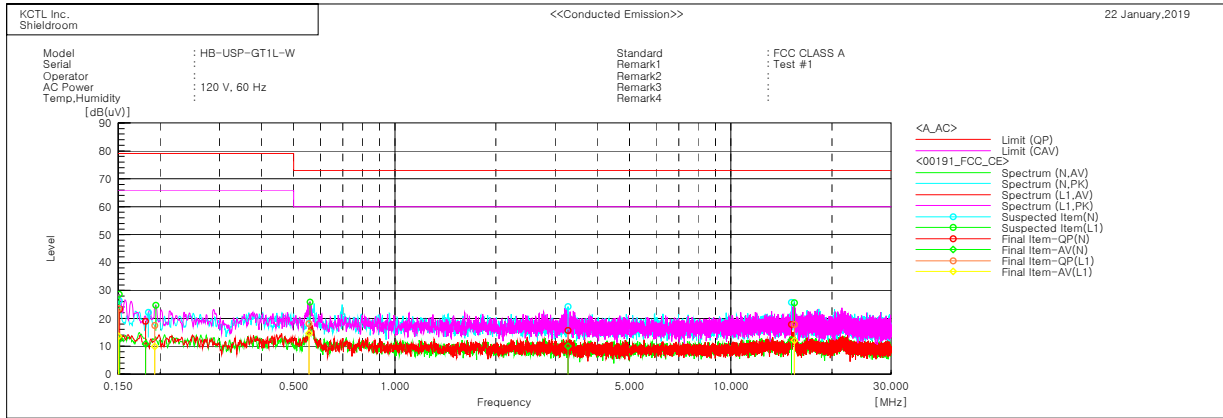

Final Result

--- N Phase ---

No.	Frequency [MHz]	Reading QP [dB(uV)]	Reading CAV [dB(uV)]	c.f [dB]	Result QP [dB(uV)]	Result CAV [dB(uV)]	Limit QP [dB(uV)]	Limit AV [dB(uV)]	Margin QP [dB]	Margin CAV [dB]
1	0.1513	13.6	3.0	9.7	23.3	12.7	79.0	66.0	55.7	53.3
2	0.18096	9.0	0.8	10.0	19.0	10.8	79.0	66.0	60.0	55.2
3	3.27464	5.9	0.3	9.7	15.6	10.0	73.0	60.0	57.4	50.0
4	15.17043	7.7	2.2	10.1	17.8	12.3	73.0	60.0	55.2	47.7

--- L1 Phase ---

No.	Frequency [MHz]	Reading QP [dB(uV)]	Reading CAV [dB(uV)]	c.f [dB]	Result QP [dB(uV)]	Result CAV [dB(uV)]	Limit QP [dB(uV)]	Limit AV [dB(uV)]	Margin QP [dB]	Margin CAV [dB]
1	0.15051	13.8	3.9	9.7	23.5	13.6	79.0	66.0	55.5	52.4
2	0.19301	7.5	0.1	9.9	17.4	10.0	79.0	66.0	61.6	56.0
3	0.55505	8.3	4.8	9.8	18.1	14.6	73.0	60.0	54.9	45.4
4	15.48206	7.8	2.1	10.0	17.8	12.1	73.0	60.0	55.2	47.9

6.2 Radiated Emission

Test specification		ANSI C63.4:2014, Class A FCC Part 15 Subpart B		
Testing voltage		120 V, 60 Hz		
Test facility		10 m Chamber (2F, 4F)		
Test distance		10 m, 3 m		
Date		2019-01-20		
10 m	Temperature (°C)	22.3 °C	Humidity (% R.H.)	13.6 % R.H.
3 m		22.4 °C		18.1 % R.H.
Remarks		Pass		

6.2.1 Limits of radiated emission measurement

Frequency [MHz]	Class A (dB(μ V/m)) @ 10 m	Class B (dB(μ V/m)) @ 3 m
30-88	39	40
88-216	43.5	43.5
216-960	46.4	46
Above 960	49.5	54

Note- Alternative standard: CISPR, Pub. 22

6.2.2 Measurement procedure

The test was done at a 10 m chamber with a quasi-peak detector. EUT was placed on a non-metallic table height of 0.8 m above the reference ground plane. Cables were folded back and forth forming a bundle 0.3 m to 0.4 m long and were hanged at a 0.4 m height to the ground plane.

Cables connected to EUT were fixed to cause maximum emission. Test was made with the antenna positioned in both the horizontal and vertical planes of polarization. The measurement antenna was varied in height above the conducting ground plane to obtain the maximum signal strength.

6.2.3 Used equipments

2F

Equipment	Model no.	Serial no.	Makers	Next Cal. Date	Used
EMI TEST RECEIVER	ESC17	100732	R&S	2019.08.23	<input checked="" type="checkbox"/>
Bilog Antenna	VULB9168	583	SCHWARZBEC K	2020.04.13	<input checked="" type="checkbox"/>
AMPLIFIER	310N	284608	SONOMA	2019.08.23	<input checked="" type="checkbox"/>
COAXIAL FIXED ATTENUATOR	8491B-003	2708A18758	AGILENT	-	<input checked="" type="checkbox"/>
Antenna Mast	MA4000-EP	303	Innco Systems	-	<input checked="" type="checkbox"/>
Turn Table	DT2000	79	Innco Systems	-	<input checked="" type="checkbox"/>

4F

Equipment	Model no.	Serial no.	Makers	Next Cal. Date	Used
EMI TEST RECEIVER	ESR7	101078	R&S	2019.08.23	<input checked="" type="checkbox"/>
Antenna Mast	MA4640-XP-ET	-	Innco Systems	-	<input checked="" type="checkbox"/>
Turn Table	TT 3.0-3t	-	MATURO	-	<input checked="" type="checkbox"/>
DOUBLE RIDGED HORN ANTENNA	3117-PA	00161083	ETS-LINDGREN	2019.09.14	<input checked="" type="checkbox"/>
Spectrum Analyzer	FSV40	100988	R&S	2020.01.04	<input checked="" type="checkbox"/>

KCTL Inc.

65, Sinwon-ro, Yeongtong-gu,
Suwon-si, Gyeonggi-do, 16677, Korea
TEL: 82-31-285-0894 FAX: 82-505-299-8311
www.kctl.co.kr

Report No.:
KR19-SEF0016

Page (20) of (30)

KCTL

6.2.4 Sample calculation

The field strength is calculated adding the antenna Factor, cable loss and, Antenna pad adding, subtracting the amplifier gain from the measured reading.

The sample calculation is as follow:

$$\text{Result} = \text{M.R} + \text{C.F}(\text{A.F} + \text{C.L} + 6 \text{ dB Att} - \text{A.G})$$

M.R = Meter Reading

C.F = Correction Factor

A.F = Antenna Factor

C.L = Cable Loss

A.G = Amplifier Gain

6 dB Att = 6 dB Attenuator

If M.R is 30 dB, A.F 12 dB, C.L 5 dB, 6 dB, A.G 35 dB

The result is $30 + 12 + 5 + 6 - 35 = 18 \text{ dB } (\mu\text{V/m})$

Bilog Antenna and ATTENUATOR (6 dB) were calibrated together.

AV = CAV : Abbreviation of CISPR Average

KCTL

KCTL Inc.

65, Sinwon-ro, Yeongtong-gu,
Suwon-si, Gyeonggi-do, 16677, Korea
TEL: 82-31-285-0894 FAX: 82-505-299-8311
www.kctl.co.kr

Report No.:
KR19-SEF0016

Page (21) of (30)



6.2.5 Photographs of test setup

30 MHz ~ 1 GHz



KCTL Inc.

65, Sinwon-ro, Yeongtong-gu,
Suwon-si, Gyeonggi-do, 16677, Korea
TEL: 82-31-285-0894 FAX: 82-505-299-8311
www.kctl.co.kr

Report No.:
KR19-SEF0016
Page (22) of (30)

KCTL

1 GHz ~ 18 GHz



KCTL Inc.

65, Sinwon-ro, Yeongtong-gu,
Suwon-si, Gyeonggi-do, 16677, Korea
TEL: 82-31-285-0894 FAX: 82-505-299-8311
www.kctl.co.kr

Report No.:
KR19-SEF0016

Page (23) of (30)



6.2.6 Radiated emission measurement result

30 MHz ~ 1 GHz

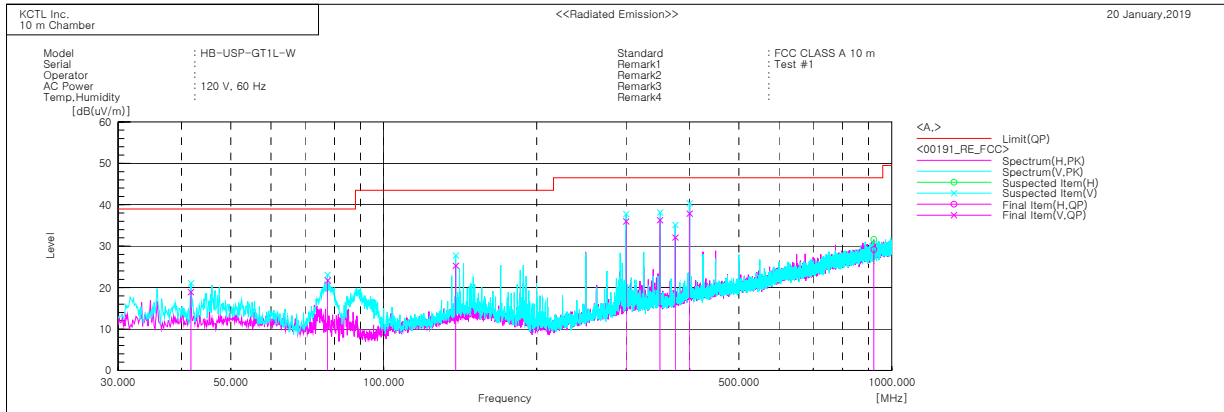

Final Result

No.	Frequency [MHz]	(P)	Reading [dB(uV)]	c. f [dB(1/m)]	Result [dB(uV/m)]	Limit [dB(uV/m)]	Margin [dB]	Height [cm]	Angle [deg]
1	41.725	V	30.5	-11.6	18.9	39.0	20.1	157.0	215.0
2	77.568	V	36.2	-14.5	21.7	39.0	17.3	157.0	215.0
3	138.627	V	34.9	-9.6	25.3	43.5	18.2	212.0	281.0
4	300.063	V	42.9	-6.9	36.0	46.5	10.5	198.0	99.0
5	349.915	V	41.6	-5.3	36.3	46.5	10.2	107.0	220.0
6	374.961	V	36.3	-4.2	32.1	46.5	14.4	215.0	321.0
7	400.028	V	41.3	-3.4	37.9	46.5	8.6	151.0	145.0
8	922.061	H	20.1	9.1	29.2	46.5	17.3	291.0	249.0

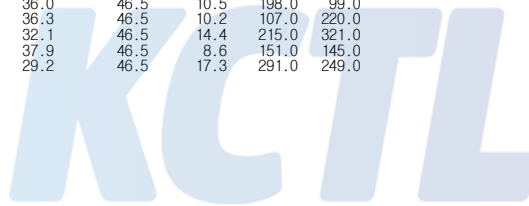

KCTL Inc.

65, Sinwon-ro, Yeongtong-gu,
Suwon-si, Gyeonggi-do, 16677, Korea
TEL: 82-31-285-0894 FAX: 82-505-299-8311
www.kctl.co.kr

Report No.:
KR19-SEF0016

Page (24) of (30)



1 GHz ~ 18 GHz

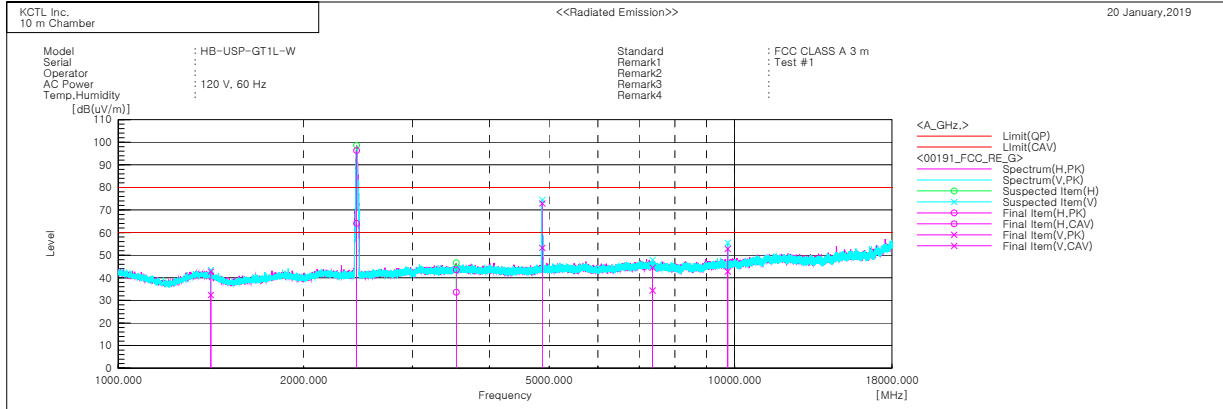

No.	Frequency [MHz]	(P)	Reading PK [dB(uV)]	Reading CAV [dB(uV)]	c.f [dB(1/m)]	Result PK [dB(uV/m)]	Result CAV [dB(uV/m)]	Limit PK [dB(uV/m)]	Limit AV [dB(uV/m)]	Margin PK [dB]	Margin CAV [dB]	Height [cm]	Angle [deg]
1	1413.061	V	58.9	48.6	-16.2	42.7	32.4	80.0	60.0	37.3	27.6	110.0	191.0
2	2435.828	H	108.6	76.4	-12.3	96.3	64.1	80.0	60.0	-16.3	-4.1	114.0	131.0
3	3536.161	H	51.2	41.3	-7.7	43.5	33.6	80.0	60.0	36.5	26.4	185.0	158.0
4	4874.161	V	78.2	58.6	-5.3	72.9	53.3	80.0	60.0	7.1	6.7	104.0	90.0
5	7359.621	V	47.7	37.6	-3.2	44.5	34.4	80.0	60.0	35.5	25.6	123.0	332.0
6	9748.361	V	52.1	42.1	0.7	52.8	42.8	80.0	60.0	27.2	17.2	109.0	90.0



Fundamental Frequency: 2 435.828 MHz

KCTL Inc.

65, Sinwon-ro, Yeongtong-gu,
Suwon-si, Gyeonggi-do, 16677, Korea
TEL: 82-31-285-0894 FAX: 82-505-299-8311
www.kctl.co.kr

Report No.:
KR19-SEF0016
Page (25) of (30)



7. EUT photographs

Front View



Rear View



KCTL Inc.

65, Sinwon-ro, Yeongtong-gu,
Suwon-si, Gyeonggi-do, 16677, Korea
TEL: 82-31-285-0894 FAX: 82-505-299-8311
www.kctl.co.kr

Report No.:
KR19-SEF0016
Page (26) of (30)

KCTL

Left View



Right View

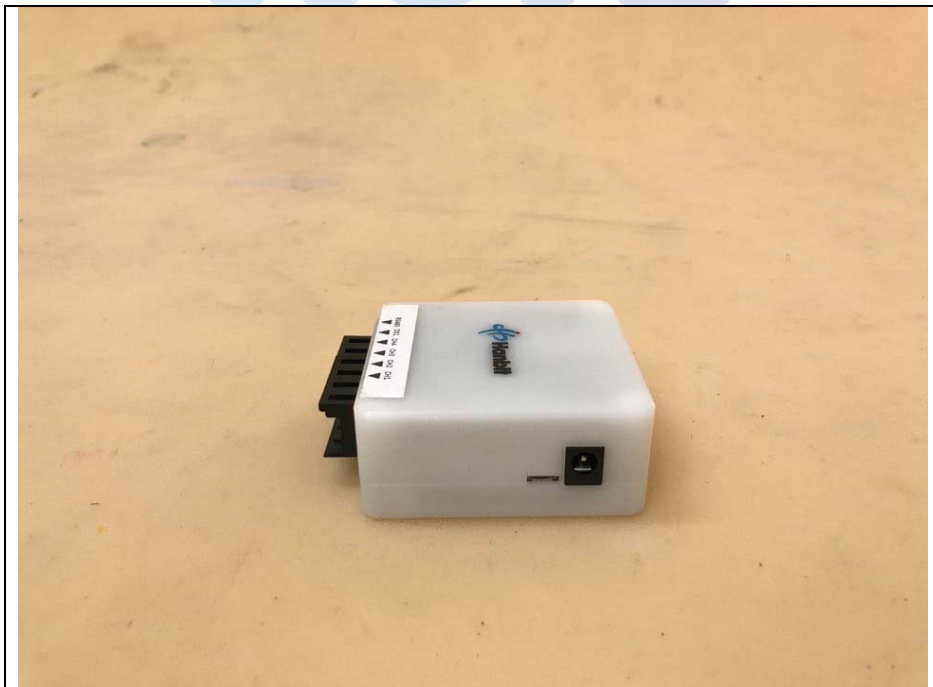

KCTL Inc.

65, Sinwon-ro, Yeongtong-gu,
Suwon-si, Gyeonggi-do, 16677, Korea
TEL: 82-31-285-0894 FAX: 82-505-299-8311
www.kctl.co.kr

Report No.:
KR19-SEF0016
Page (27) of (30)

KCTL

Top View



Bottom View



KCTL Inc.

65, Sinwon-ro, Yeongtong-gu,
Suwon-si, Gyeonggi-do, 16677, Korea
TEL: 82-31-285-0894 FAX: 82-505-299-8311
www.kctl.co.kr

Report No.:
KR19-SEF0016

Page (28) of (30)

KCTL

Inside



KCTL Inc.

65, Sinwon-ro, Yeongtong-gu,
Suwon-si, Gyeonggi-do, 16677, Korea
TEL: 82-31-285-0894 FAX: 82-505-299-8311
www.kctl.co.kr

Report No.:
KR19-SEF0016
Page (29) of (30)

KCTL

Dipole ANT



KCTL Inc.

65, Sinwon-ro, Yeongtong-gu,
Suwon-si, Gyeonggi-do, 16677, Korea
TEL: 82-31-285-0894 FAX: 82-505-299-8311
www.kctl.co.kr

Report No.:
KR19-SEF0016
Page (30) of (30)



Adapter

