



TESTING LABORATORY
CERTIFICATE#4323.01



FCC PART 15.247 TEST REPORT

For

FUJIAN YIHE ELECTRONICS CO., LTD.

JIAN ROAD, QINXIYANG INDUSTRIAL PARK, FUAN, FUJIAN, 355000 China

FCC ID: 2ASBG-YH9201L

Report Type: Original Report	Product Type: Massage chair
Test Engineer:	Chao Gao <i>Chao Gao</i>
Report Number:	RXM200720050-00A
Report Date:	2020-08-21
Reviewed By:	Oscar Ye EMC Manager <i>Oscar Ye</i>
Prepared By:	Bay Area Compliance Laboratories Corp. (Kunshan) No.248 Chenghu Road, Kunshan, Jiangsu province, China Tel: +86-0512-86175000 Fax: +86-0512-88934268 www.baclcorp.com.cn

TABLE OF CONTENTS

GENERAL INFORMATION.....4

 PRODUCT DESCRIPTION FOR EQUIPMENT UNDER TEST (EUT).....4

 OBJECTIVE.....4

 RELATED SUBMITTAL(S)/GRANT(S).....4

 TEST METHODOLOGY.....5

 MEASUREMENT UNCERTAINTY.....5

 TEST FACILITY.....5

SYSTEM TEST CONFIGURATION.....6

 DESCRIPTION OF TEST CONFIGURATION.....6

 EUT EXERCISE SOFTWARE.....6

 SPECIAL ACCESSORIES.....6

 EQUIPMENT MODIFICATIONS.....6

 SUPPORT EQUIPMENT LIST AND DETAILS.....7

 EXTERNAL I/O CABLE.....7

 BLOCK DIAGRAM OF TEST SETUP.....7

SUMMARY OF TEST RESULTS.....9

TEST EQUIPMENT LIST.....10

FCC §1.1310 & §2.1091- MAXIMUM PERMISSIBLE EXPOSURE (MPE).....11

FCC §15.203 - ANTENNA REQUIREMENT.....12

 APPLICABLE STANDARD.....12

 ANTENNA CONNECTOR CONSTRUCTION.....12

FCC §15.207 (a) – AC LINE CONDUCTED EMISSIONS.....13

 APPLICABLE STANDARD.....13

 EUT SETUP.....13

 EMI TEST RECEIVER SETUP.....13

 TEST PROCEDURE.....13

 FACTOR & OVER LIMIT CALCULATION.....14

 TEST RESULTS SUMMARY.....14

 TEST DATA.....14

FCC §15.205, §15.209 & §15.247(d) – RADIATED EMISSIONS.....17

 APPLICABLE STANDARD.....17

 EUT SETUP.....17

 EMI TEST RECEIVER SETUP.....18

 TEST PROCEDURE.....18

 TEST RESULTS SUMMARY.....18

 TEST DATA.....19

FCC §15.247(a) (1)-CHANNEL SEPARATION TEST.....30

 APPLICABLE STANDARD.....30

 TEST PROCEDURE.....30

 TEST DATA.....30

FCC §15.247(a) (1) – 20 dB EMISSION BANDWIDTH.....36

 APPLICABLE STANDARD.....36

 TEST PROCEDURE.....36

 TEST DATA.....36

FCC §15.247(a) (1) (iii)-QUANTITY OF HOPPING CHANNEL TEST.....42

 APPLICABLE STANDARD.....42

 TEST PROCEDURE.....42

 TEST DATA.....42

FCC §15.247(a) (1) (iii) - TIME OF OCCUPANCY (DWELL TIME)	45
APPLICABLE STANDARD	45
TEST PROCEDURE	45
TEST DATA	45
FCC §15.247(b) (1) - PEAK OUTPUT POWER MEASUREMENT	61
APPLICABLE STANDARD	61
TEST PROCEDURE	61
TEST DATA	61
FCC §15.247(d) - BAND EDGES TESTING	67
APPLICABLE STANDARD	67
TEST PROCEDURE	67
TEST DATA	67

GENERAL INFORMATION

Product Description for Equipment under Test (EUT)

Applicant	FUJIAN YIHE ELECTRONICS CO., LTD.
Tested Model	YH-9201L
Series Model	Brookstone BK-250, Ergotec ET-210, AD-Elite II, AP-Marcus, AD-Sigma V, YH-8350L, YH-8330L, YH-8360, YH-8320L, YH-9200L, YH-9202L, YH-8270L, YH-8380, Titan Regal II
Product Type	Massage chair
Power Supply	AC 100-240 V
RF Function	Classic BT
Operating Band/Frequency	2402-2480 MHz
Channel Number	79
Channel Separation	1MHz
Modulation Type	GFSK, $\pi/4$ -DQPSK, 8DPSK
Antenna Type	PCB antenna
Maximum Antenna Gain	0 dBi

Note: The model difference was explained in the attached declaration letter.

**All measurement and test data in this report was gathered from production sample serial number: 20200720050. (Assigned by the BACL. The EUT supplied by the applicant was received on 2020-07-20)*

Objective

This test report is prepared on behalf of *FUJIAN YIHE ELECTRONICS CO., LTD.* in accordance with Part 2-Subpart J, Part 15-Subparts A and C of the Federal Communication Commissions rules.

The tests were performed in order to determine Compliance with FCC Part 15, Subpart C, section 15.203, 15.205, 15.207, 15.209 and 15.247 rules.

Related Submittal(s)/Grant(s)

No related submittal(s)/grant(s)

Test Methodology

All measurements contained in this report were conducted with ANSI C63.10-2013, American National Standard of Procedures for Compliance Testing of Unlicensed Wireless Devices and 558074 D01 15.247 Meas Guidance v05r02.

All emissions measurement was performed and Bay Area Compliance Laboratories Corp. (Kunshan). The radiated testing was performed at an antenna-to-EUT distance of 3 meters.

Measurement Uncertainty

Item		Uncertainty
AC Power Lines Conducted Emissions		3.19dB
RF conducted test with spectrum		0.9dB
RF Output Power with Power meter		0.5dB
Radiated emission	30MHz~1GHz	6.11dB
	1GHz~6GHz	4.45dB
	6GHz~18GHz	5.23dB
	18GHz~40GHz	5.65dB
Occupied Bandwidth		0.5kHz
Temperature		1.0°C
Humidity		6%

Otherwise required by the applicant or Product Regulations, Decision Rule in this report did not consider the uncertainty.

Test Facility

The test site used by Bay Area Compliance Laboratories Corp. (Kunshan) to collect test data is located on the No.248 Chenghu Road, Kunshan, Jiangsu province, China.

Bay Area Compliance Laboratories Corp. (Kunshan) Lab is accredited to ISO/IEC 17025 by A2LA (Lab code: 4323.01) and the FCC designation No. CN1185 under the FCC KDB 974614 D01 and CAB identifier CN0004 under the ISED requirement. The facility also complies with the radiated and AC line conducted test site criteria set forth in ANSI C63.4-2014.

SYSTEM TEST CONFIGURATION

Description of Test Configuration

Channel list for Bluetooth:

Channel	Frequency (MHz)	Channel	Frequency (MHz)
0	2402	40	2442
1	2403
...
...	...	78	2480
39	2441	/	/

EUT was tested with Channel 0, 39 and 78.

EUT Exercise Software

RF test software: RDA ToolKit

GFSK, $\pi/4$ -DQPSK, 8DPSK Power level setting: 2

Special Accessories

No special accessory.

Equipment Modifications

No modification was made to the EUT tested.

Support Equipment List and Details

Manufacturer	Description	Model	Serial Number
/	/	/	/

External I/O Cable

Cable Description	Length (m)	From Port	To
Power Cable	1.0	EUT	LISN/AC Source

Block Diagram of Test Setup

For Conducted Emissions:

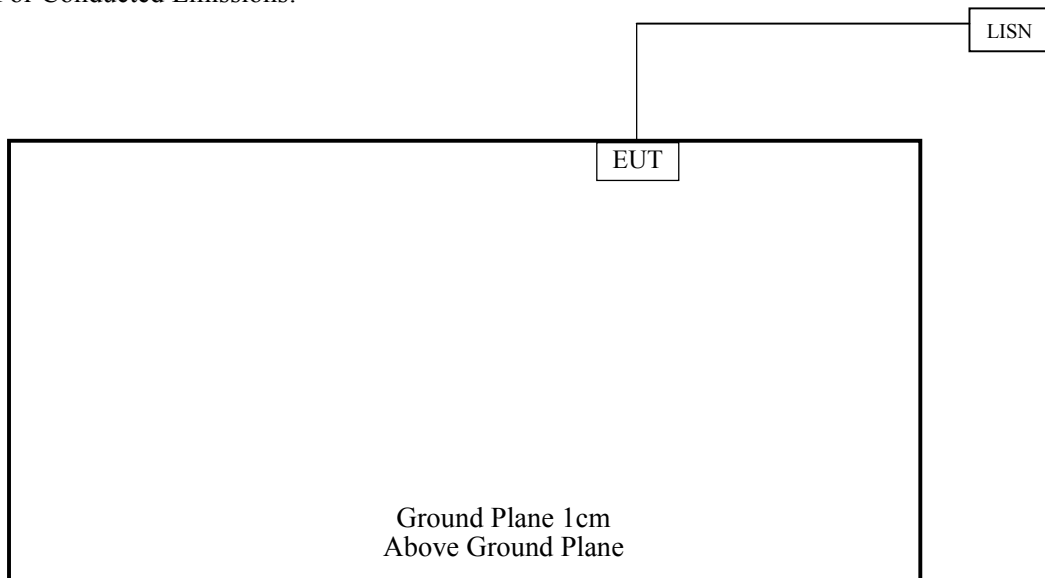

For Radiated Emissions(Below 1GHz & Above 1GHz):

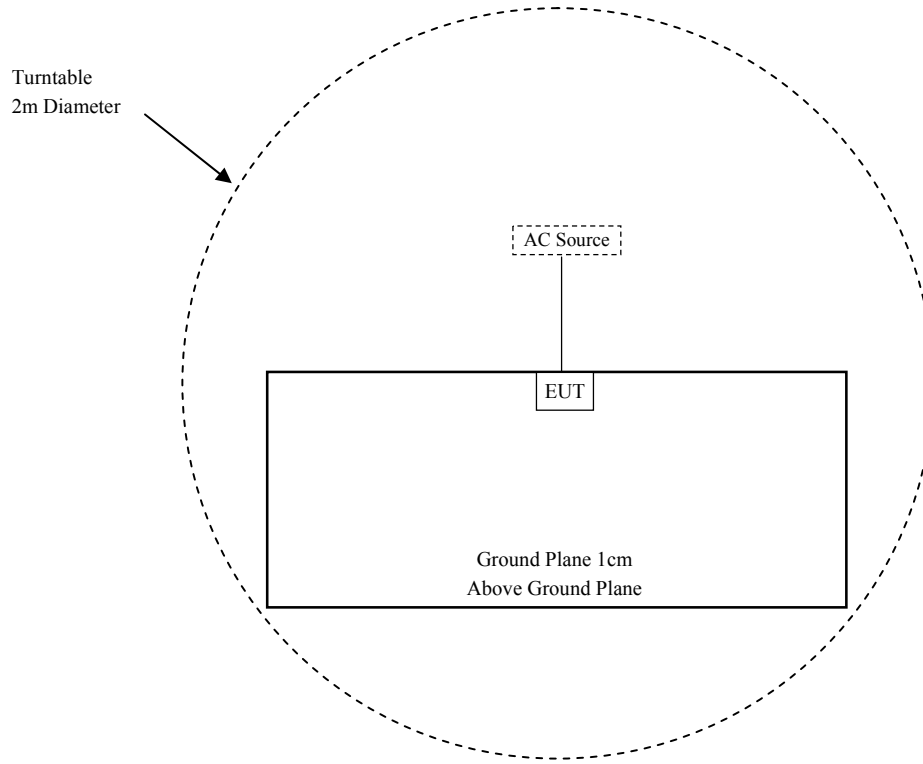

SUMMARY OF TEST RESULTS

FCC Rules	Description of Test	Result
§15.247 (I), §1.1310 & §2.1091	Maximum Permissible Exposure (MPE)	Compliant
§15.203	Antenna Requirement	Compliant
§15.207(a)	AC Line Conducted Emissions	Compliant
§15.205, §15.209 & §15.247(d)	Radiated Emissions & Restricted Bands Emissions	Compliant
§15.247(a)(1)	20 dB Emission Bandwidth	Compliant
§15.247(a)(1)	Channel Separation Test	Compliant
§15.247(a)(1)(iii)	Time of Occupancy (Dwell Time)	Compliant
§15.247(a)(1)(iii)	Quantity of Hopping Channel Test	Compliant
§15.247(b)(1)	Peak Output Power Measurement	Compliant
§15.247(d)	Band Edges	Compliant

TEST EQUIPMENT LIST

Manufacturer	Description	Model	Serial Number	Calibration Date	Calibration Due Date
Radiated Emission Test (Chamber 1#)					
Rohde & Schwarz	EMI Test Receiver	ESCI	100195	2019-12-14	2020-12-13
Sunol Sciences	Broadband Antenna	JB3	A090413-1	2019-12-26	2022-12-25
Sonoma Instrument	Pre-amplifier	310N	171205	2019-08-14	2020-08-13
Rohde & Schwarz	Auto test Software	EMC32	100361	/	/
MICRO-COAX	Coaxial Cable	Cable-8	008	2019-08-15	2020-08-14
MICRO-COAX	Coaxial Cable	Cable-9	009	2019-08-15	2020-08-14
MICRO-COAX	Coaxial Cable	Cable-10	010	2019-08-15	2020-08-14
Radiated Emission Test (Chamber 2#)					
Rohde & Schwarz	EMI Test Receiver	ESU40	100207	2020-04-01	2021-03-31
ETS-LINDGREN	Horn Antenna	3115	9207-3900	2020-07-15	2021-07-14
ETS-LINDGREN	Horn Antenna	3116	00084159	2020-01-17	2023-01-16
A.H.Systems,inc	Amplifier	PAM-0118P	512	2020-02-20	2021-02-19
EM Electronics Corporation	Amplifier	EM18G40G	060726	2020-03-22	2021-03-21
MICRO-TRONICS	Band Reject Filter	BRM50702	G024	2019-08-05	2020-08-04
Narda	Attenuator	10dB	010	2019-08-15	2020-08-14
Audix	Test Software	e3	V9	/	/
Rohde & Schwarz	Auto test Software	EMC32	100361	/	/
MICRO-COAX	Coaxial Cable	Cable-6	006	2019-08-15	2020-08-14
MICRO-COAX	Coaxial Cable	Cable-11	011	2019-08-15	2020-08-14
MICRO-COAX	Coaxial Cable	Cable-12	012	2019-08-15	2020-08-14
MICRO-COAX	Coaxial Cable	Cable-13	013	2019-08-15	2020-08-14
RF Conducted Test					
Rohde & Schwarz	EMI Test Receiver	ESIB26	100146	2019-12-14	2020-12-13
Rohde & Schwarz	Signal Analyzer	FSV40	101116	2020-07-23	2021-07-22
Narda	Attenuator	10dB	010	2019-08-15	2020-08-14
FUJIAN YIHE ELECTRONICS	RF Cable	FUJIAN YIHE ELECTRONICS C01	C01	Each Time	/
Conducted Emission Test					
Rohde & Schwarz	EMI Test Receiver	ESR	1316.3003K03-101746-zn	2020-08-05	2021-08-04
Rohde & Schwarz	LISN	ENV216	101115	2019-12-14	2020-12-13
Audix	Test Software	e3	V9	/	/
Rohde & Schwarz	Pulse limiter	ESH3-Z2	0357.8810.54	2020-08-10	2021-08-09
MICRO-COAX	Coaxial Cable	Cable-15	015	2020-08-15	2021-08-14

* **Statement of Traceability:** Bay Area Compliance Laboratories Corp. (Kunshan) attests that all calibrations have been performed in accordance to requirements that traceable to National Primary Standards and International System of Units (SI).

FCC §1.1310 & §2.1091- MAXIMUM PERMISSIBLE EXPOSURE (MPE)

Applicable Standard

According to subpart 15.247 (i) and subpart 1.1310, 2.1091 systems operating under the provisions of this section shall be operated in a manner that ensures the public is not exposed to RF energy level in excess of the communication guidelines.

Limits for General Population/Uncontrolled Exposure				
Frequency Range (MHz)	Electric Field Strength (V/m)	Magnetic Field Strength (A/m)	Power Density (mW/cm ²)	Averaging Time (minutes)
0.3-1.34	614	1.63	*(100)	30
1.34-30	824/f	2.19/f	*(180/f ²)	30
30-300	27.5	0.073	0.2	30
300-1500	/		f/1500	30
1500-100,000	/		1.0	30

f = frequency in MHz; * = Plane-wave equivalent power density

Calculated Formulary:

Predication of MPE limit at a given distance

$S = PG/4\pi R^2$ = power density (in appropriate units, e.g. mW/cm²);

P = power input to the antenna (in appropriate units, e.g., mW);

G = power gain of the antenna in the direction of interest relative to an isotropic radiator, the power gain factor, is normally numeric gain;

R = distance to the center of radiation of the antenna (appropriate units, e.g., cm);

Calculated Data (worst case):

Mode	Frequency Range (MHz)	Maximum Antenna Gain		Tune-up Conducted Power		Evaluation Distance (cm)	Power Density (mW/cm ²)	MPE Limit (mW/cm ²)
		(dBi)	(numeric)	(dBm)	(mW)			
Bluetooth	2402-2480	0.00	1.00	-3.00	0.50	20	0.0001	1.00

Conclusion: The device meets MPE at distance 20cm.

FCC §15.203 - ANTENNA REQUIREMENT

Applicable Standard

According to § 15.203, an intentional radiator shall be designed to ensure that no antenna other than that furnished by the responsible party shall be used with the device. The use of a permanently attached antenna or of an antenna that uses a unique coupling to the intentional radiator shall be considered sufficient to comply with the provisions of this section. The manufacturer may design the unit so that a broken antenna can be replaced by the user, but the user of a standard antenna jack or electrical connector is prohibited. The structure and application of the EUT were analyzed to determine Compliance with section §15.203 of the rules. §15.203 state that the subject device must meet the following criteria:

- a. Antenna must be permanently attached to the unit.
 - b. Antenna must use a unique type of connector to attach to the EUT.
- Unit must be professionally installed, and installer shall be responsible for verifying that the correct antenna is employed with the unit.

And according to FCC 47 CFR section 15.247 (b), if the transmitting antennas of directional gain greater than 6dBi are used, the power shall be reduced by the amount in dB that the directional gain of the antenna exceeds 6 dBi.

Antenna Connector Construction

The EUT has a PCB antenna for Bluetooth, and the antenna gain is 0 dBi, the EUT is permanently attached to the unit, fulfill the requirement of this section. Please refer to the EUT photos.

Result: Compliant.

FCC §15.207 (a) – AC LINE CONDUCTED EMISSIONS

Applicable Standard

FCC §15.207(a)

EUT Setup

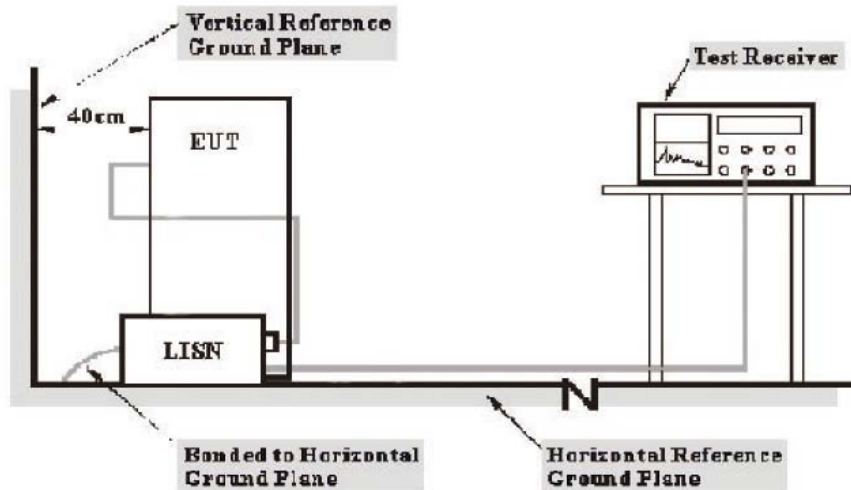

Note: 1. Support units were connected to second LISN.
 2. Both of LISNs (AMN) 80 cm from EUT and at the least 30 cm from other units and other metal planes support units.

The measurement procedure of EUT setup is according with ANSI C63.10-2013. The related limit was specified in FCC Part 15.207.

EMI Test Receiver Setup

The EMI test receiver was set to investigate the spectrum from 150 kHz to 30 MHz.

During the conducted emission test, the EMI test receiver was set with the following configurations:

Frequency Range	IF B/W
150 kHz – 30 MHz	9 kHz

Test Procedure

During the conducted emission test, the EUT was connected to the outlet of the LISN.

Maximizing procedure was performed on the six (6) highest emissions of the EUT.

All final data was recorded in the Quasi-peak and average detection mode.

Factor & Over Limit Calculation

The Factor is calculated by adding LISN VDF (Voltage Division Factor), Cable Loss and Transient Limiter Attenuation. The basic equation is as follows:

$$\text{Factor (dB)} = \text{LISN VDF (dB)} + \text{Cable Loss (dB)} + \text{Transient Limiter Attenuation (dB)}$$

The “**Over Limit**” column of the following data tables indicates the degree of compliance with the applicable limit. For example, an Over Limit of 7 dB means the emission is 7 dB above the limit. The equation for Over Limit calculation is as follows:

$$\text{Over Limit (dB)} = \text{Read level (dB}\mu\text{V)} + \text{Factor (dB)} - \text{Limit (dB}\mu\text{V)}$$

Test Results Summary

According to the recorded data in following table, the EUT complied with the FCC Part 15.207.

Test Data

Environmental Conditions

Temperature:	26.5 °C
Relative Humidity:	62 %
ATM Pressure:	101.1 kPa

The testing was performed by Chao Gao on 2020-08-21.

EUT operation mode: Transmitting in high channel of 8DPSK mode (worst case)

Test Result: Compliant.

AC 120V/60 Hz, Line

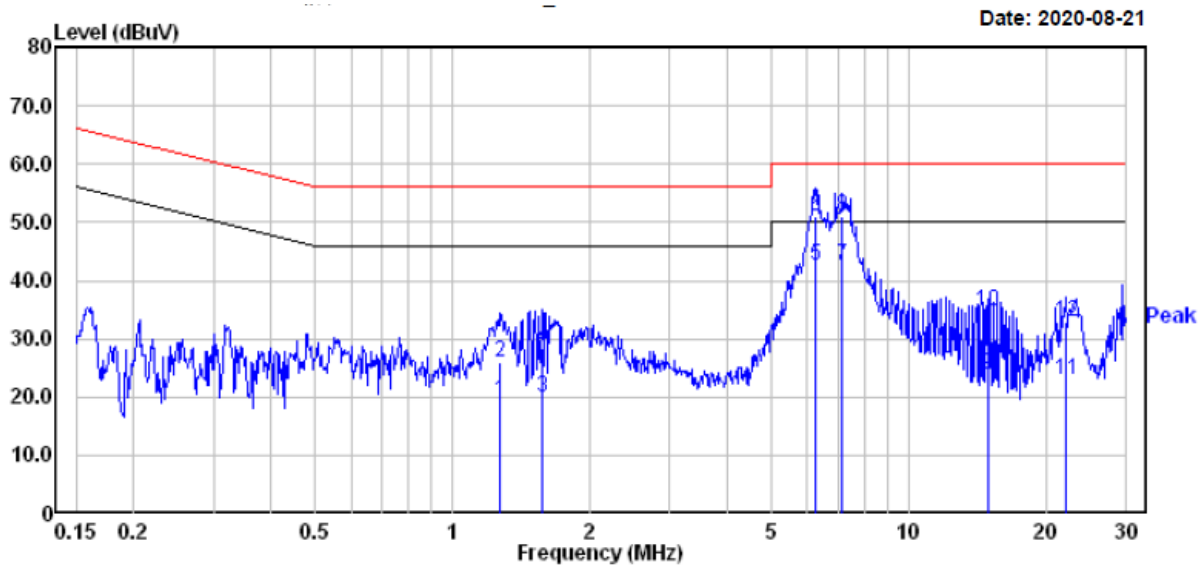

	Read Freq	Read Level	Read Factor	Limit Level	Over Limit	Remark
	MHz	dBUV	dB	dBUV	dBUV	dB
1	1.276	-0.61	19.82	19.21	46.00	-26.79 Average
2	1.276	6.29	19.82	26.11	56.00	-29.89 QP
3	1.577	0.10	19.85	19.95	46.00	-26.05 Average
4	1.577	8.50	19.85	28.35	56.00	-27.65 QP
5	6.252	23.15	19.51	42.66	50.00	-7.34 Average
6	6.252	31.55	19.51	51.06	60.00	-8.94 QP
7	7.175	23.07	19.52	42.59	50.00	-7.41 Average
8	7.175	31.47	19.52	50.99	60.00	-9.01 QP
9	14.907	4.17	19.63	23.80	50.00	-26.20 Average
10	14.907	14.97	19.63	34.60	60.00	-25.40 QP
11	22.180	3.10	19.84	22.94	50.00	-27.06 Average
12	22.180	13.10	19.84	32.94	60.00	-27.06 QP

AC 120V/60 Hz, Neutral

Date: 2020-08-21

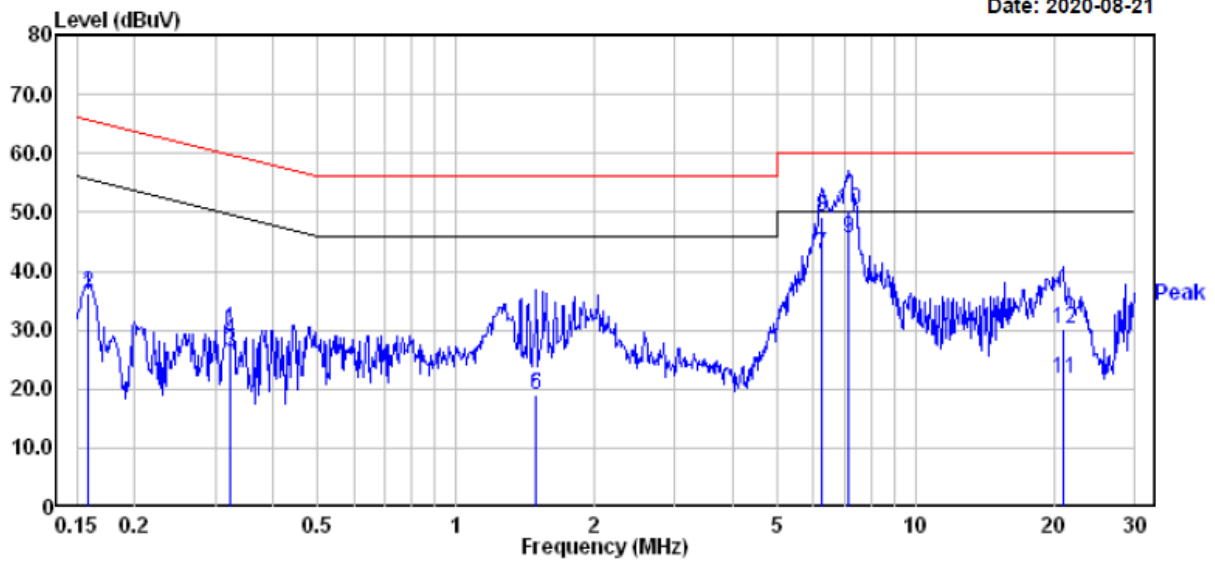

	Read Freq	Read Level	Factor	Level	Limit	Over	Remark
	MHz	dBuV	dB	dBuV	dBuV	dB	
1	0.158	16.10	19.82	35.92	55.56	-19.64	Average
2	0.158	16.30	19.82	36.12	65.56	-29.44	QP
3	0.323	6.40	19.82	26.22	49.62	-23.40	Average
4	0.323	8.70	19.82	28.52	59.62	-31.10	QP
5	1.495	-0.70	19.84	19.14	46.00	-26.86	Average
6	1.495	-0.70	19.84	19.14	56.00	-36.86	QP
7	6.252	23.40	19.51	42.91	50.00	-7.09	Average
8	6.252	29.60	19.51	49.11	60.00	-10.89	QP
9	7.175	26.20	19.52	45.72	50.00	-4.28	Average
10	7.175	30.90	19.52	50.42	60.00	-9.58	QP
11	21.035	1.70	19.90	21.60	50.00	-28.40	Average
12	21.035	10.20	19.90	30.10	60.00	-29.90	QP

Note:

- 1) Factor (dB) = LISN VDF (dB) + Cable Loss (dB) + Transient Limiter Attenuation (dB)
- 2) Over Limit (dB) = Read level (dBμV) + Factor (dB) - Limit (dBμV)

FCC §15.205, §15.209 & §15.247(d) – RADIATED EMISSIONS

Applicable Standard

FCC §15.205; §15.209; §15.247(d)

EUT Setup

Below 1 GHz:

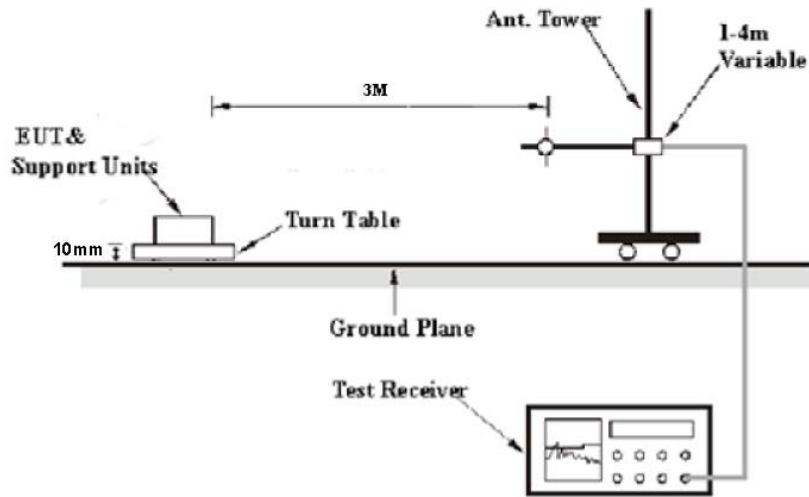

Above 1GHz:

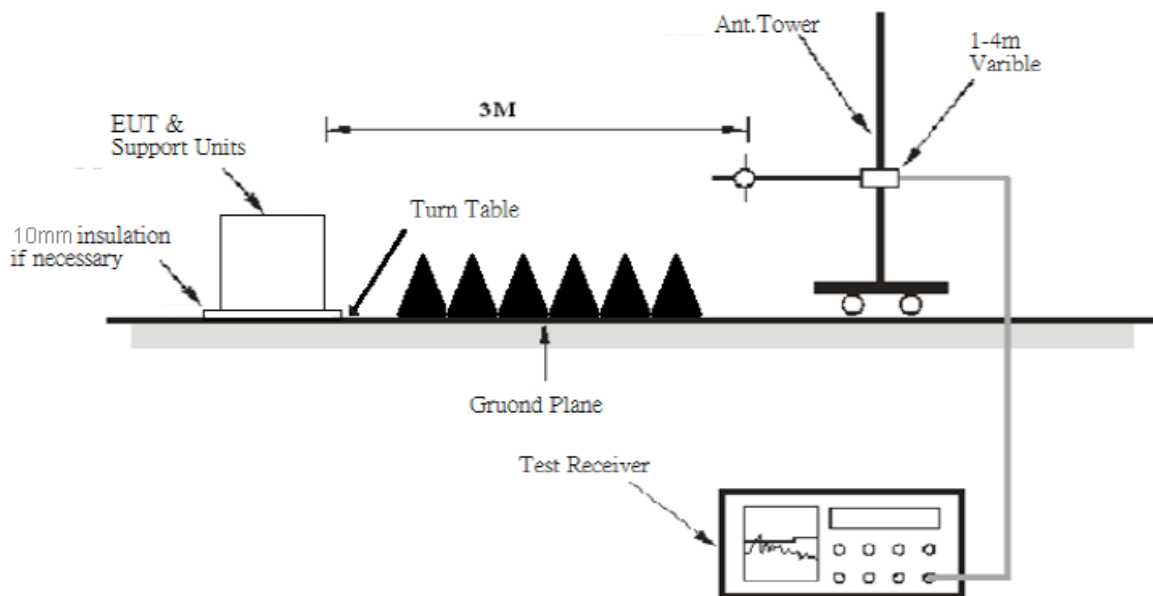

The radiated emission tests were performed in the 3 meters, using the setup accordance with the ANSI C63.10-2013. The specification used was the FCC 15.209 and FCC 15.247 limits.

EMI Test Receiver Setup

The system was investigated from 30 MHz to 25 GHz.

During the radiated emission test, the EMI test receiver Setup was set with the following configurations:

Frequency Range	RBW	Video B/W	IF B/W	Detector
30 MHz – 1000 MHz	120 kHz	300 kHz	120 kHz	QP
Above 1GHz	1MHz	3 MHz	/	PK
	1MHz	3 MHz	/	Ave.

Test Procedure

Maximizing procedure was performed on the highest emissions to ensure that the EUT complied with all installation combinations.

All final data was recorded in Quasi-peak detection mode for frequency range of 30 MHz -1 GHz and peak and Average detection modes for frequencies above 1 GHz.

Corrected Amplitude & Margin Calculation

The Corrected Amplitude is calculated by adding the Antenna Factor and Cable Loss, and subtracting the Amplifier Gain from the Meter reading. The basic equation is as follows:

$$\text{Corr. Amp.} = \text{Meter Reading} + \text{Antenna Factor} + \text{Cable Loss} - \text{Amplifier Gain}$$

The “**Margin**” column of the following data tables indicates the degree of compliance with the applicable limit. For example, a margin of 7dB means the emission is 7dB below the limit. The equation for margin calculation is as follows:

$$\text{Margin} = \text{Limit} - \text{Corrected Amp}$$

Test Results Summary

According to the recorded data in following table, the EUT complied with the FCC Title 47, Part 15, Subpart C, section 15.205, 15.209 and 15.247.

Test Data

Environmental Conditions

Temperature:	23.5~25.7 °C
Relative Humidity:	51~71 %
ATM Pressure:	100.9~101.6 kPa

The testing was performed by Chao Gao from 2020-07-28 to 2020-08-01.

EUT operation mode: Transmitting

Test Result: Compliant.

Spurious Emission Test:

30MHz-1GHz:

Pre-Scan with GFSK, $\pi/4$ -DQPSK, 8DPSK modes, the worst case **low channel of 8DPSK Mode** was recorded

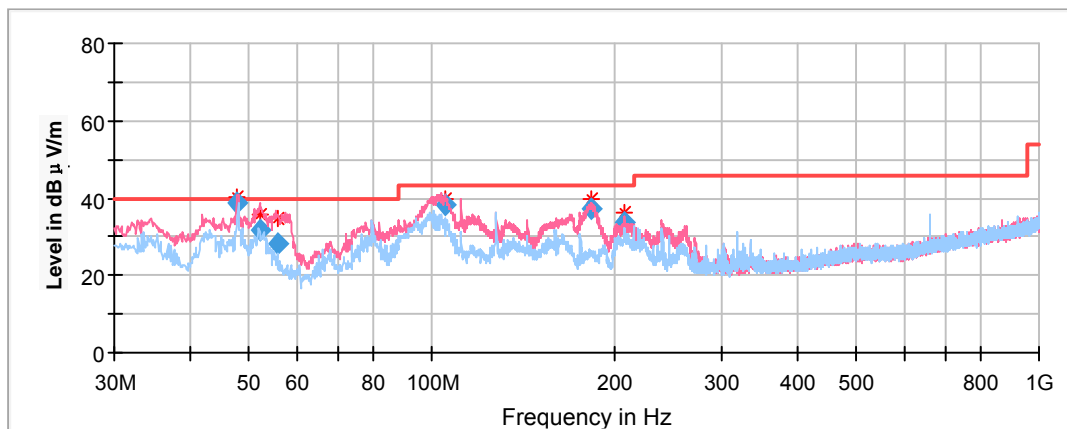

Frequency (MHz)	Corrected Amplitude	Rx Antenna		Turntable Degree	Corrected Factor (dB/m)	Limit (dBµV/m)	Margin (dB)
	Quasi-peak (dBµV/m)	Height (cm)	Polar (H/V)				
47.903850	38.54	100.0	V	83.0	-16.5	40.00	1.46
52.273900	31.46	100.0	V	192.0	-18.1	40.00	8.54
55.643050	28.39	100.0	V	5.0	-18.2	40.00	11.61
104.847100	38.30	100.0	V	298.0	-14.4	43.50	5.20
183.314300	37.39	100.0	V	110.0	-13.9	43.50	6.11
207.779850	33.50	100.0	V	319.0	-12.7	43.50	10.00

1GHz-18GHz:

Pre-Scan with GFSK, π/4-DQPSK, 8DPSK modes of operation in the X,Y and Z axes of orientation, the worst case GFSK Mode in X-axis of orientation was recorded

Note:

1. This test was performed with the 2.4-2.5 GHz notch filter.
2. Corrected Factor (dB/m) = Antenna factor (RX) (dB/m) + Cable Loss (dB) – Amplifier Factor (dB)
 Corrected Amplitude (dBμV/m) = Corrected Factor (dB/m) + Reading (dBμV)
 Margin (dB) = Limit (dBμV/m) – Corrected Amplitude (dBμV/m)

Low Channel: 2402MHz

Full Spectrum

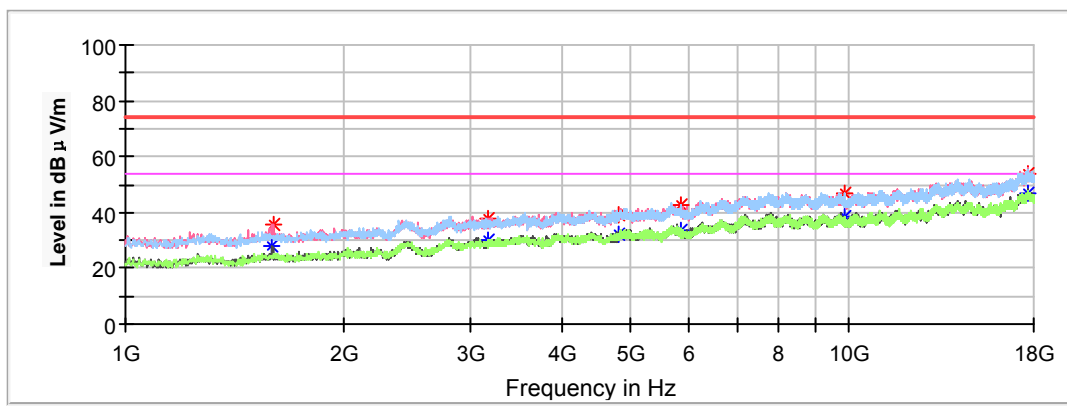

Frequency (MHz)	Corrected Amplitude		Rx Antenna		Turntable Degree	Corrected Factor (dB/m)	Limit (dBμV/m)	Margin (dB)
	MaxPeak (dBμV/m)	Average (dBμV/m)	Height (cm)	Polar (H/V)				
1596.700000	---	28.10	150.0	V	283.0	-16.0	54.00	25.90
1598.400000	35.97	---	150.0	V	283.0	-16.0	74.00	38.03
3172.600000	---	30.03	200.0	V	237.0	-9.7	54.00	23.97
3177.700000	37.68	---	200.0	V	237.0	-9.6	74.00	36.32
4804.000000	---	32.30	150.0	H	199.0	-5.6	54.00	21.70
4804.000000	39.41	---	150.0	H	199.0	-5.6	74.00	34.59
5841.600000	---	33.90	200.0	H	217.0	-3.3	54.00	20.10
5846.700000	42.82	---	200.0	H	217.0	-3.3	74.00	31.18
9838.300000	---	38.14	150.0	H	174.0	2.0	54.00	15.86
9838.300000	46.68	---	150.0	H	174.0	2.0	74.00	27.32
17639.600000	---	47.08	150.0	H	314.0	8.9	54.00	6.92
17648.100000	54.11	---	150.0	H	314.0	8.9	74.00	19.89

Middle Channel: 2441MHz

Full Spectrum

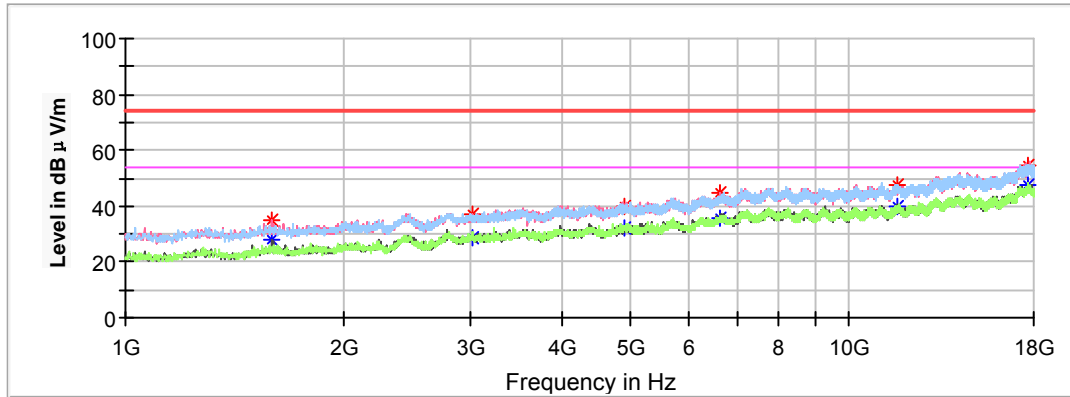

Frequency (MHz)	Corrected Amplitude		Rx Antenna		Turntable Degree	Corrected Factor (dB/m)	Limit (dBμV/m)	Margin (dB)
	MaxPeak (dBμV/m)	Average (dBμV/m)	Height (cm)	Polar (H/V)				
1595.000000	35.30	---	150.0	V	306.0	-16.0	74.00	38.70
1596.700000	---	28.14	150.0	V	306.0	-16.0	54.00	25.86
3019.600000	37.35	---	200.0	V	296.0	-10.0	74.00	36.65
3019.600000	---	28.64	200.0	V	296.0	-10.0	54.00	25.36
4882.000000	---	32.35	200.0	V	195.0	-5.4	54.00	21.65
4882.000000	40.09	---	200.0	V	195.0	-5.4	74.00	33.91
6632.100000	45.02	---	150.0	V	187.0	-0.9	74.00	28.98
6632.100000	---	35.99	150.0	V	187.0	-0.9	54.00	18.01
11650.500000	47.38	---	200.0	H	245.0	3.1	74.00	26.62
11650.500000	---	39.71	200.0	H	245.0	3.1	54.00	14.29
17685.500000	54.79	---	200.0	H	0.0	8.9	74.00	19.21
17685.500000	---	47.55	200.0	H	0.0	8.9	54.00	6.45

High Channel: 2480MHz

Full Spectrum

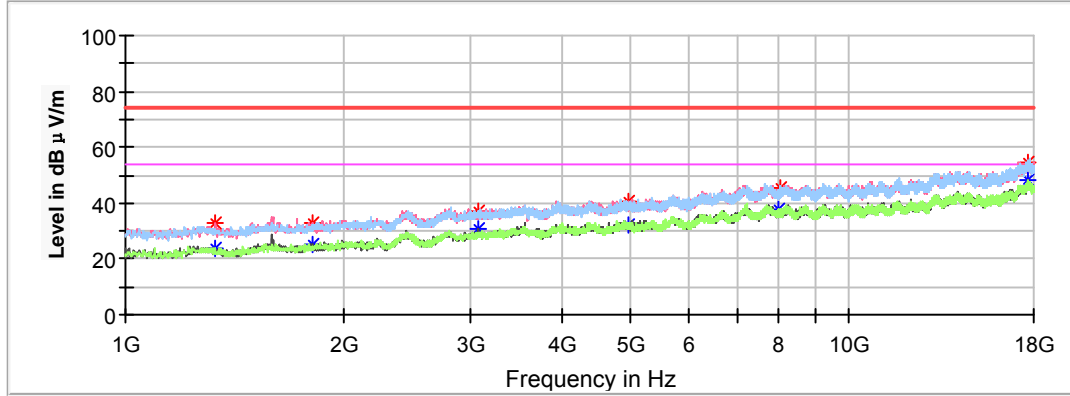

Frequency (MHz)	Corrected Amplitude		Rx Antenna		Turntable Degree	Corrected Factor (dB/m)	Limit (dBμV/m)	Margin (dB)
	MaxPeak (dBμV/m)	Average (dBμV/m)	Height (cm)	Polar (H/V)				
1333.200000	---	23.66	200.0	V	336.0	-17.3	54.00	30.34
1333.200000	32.81	---	200.0	V	336.0	-17.3	74.00	41.19
1812.600000	---	25.21	150.0	V	259.0	-15.2	54.00	28.79
1812.600000	33.08	---	150.0	V	259.0	-15.2	74.00	40.92
3072.300000	---	30.64	150.0	V	217.0	-9.9	54.00	23.36
3072.300000	37.05	---	150.0	V	217.0	-9.9	74.00	36.95
4960.000000	---	32.46	150.0	V	340.0	-5.3	54.00	21.54
4960.000000	40.62	---	150.0	V	340.0	-5.3	74.00	33.38
8014.200000	---	37.82	150.0	H	38.0	1.8	54.00	16.18
8014.200000	45.23	---	150.0	H	38.0	1.8	74.00	28.77
17661.700000	54.77	---	200.0	H	233.0	8.9	74.00	19.23
17661.700000	---	47.98	200.0	H	233.0	8.9	54.00	6.02

18GHz-25GHz:

Pre-Scan with GFSK, $\pi/4$ -DQPSK, 8DPSK modes of operation in the X,Y and Z axes of orientation, the worst case middle channel of GFSK Mode in X-axis of orientation was recorded

Horizontal

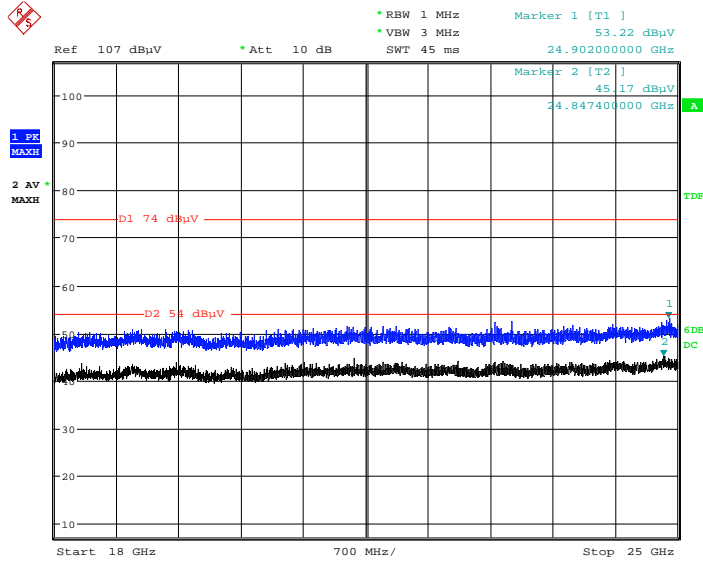

Date: 31.JUL.2020 09:39:49

Vertical

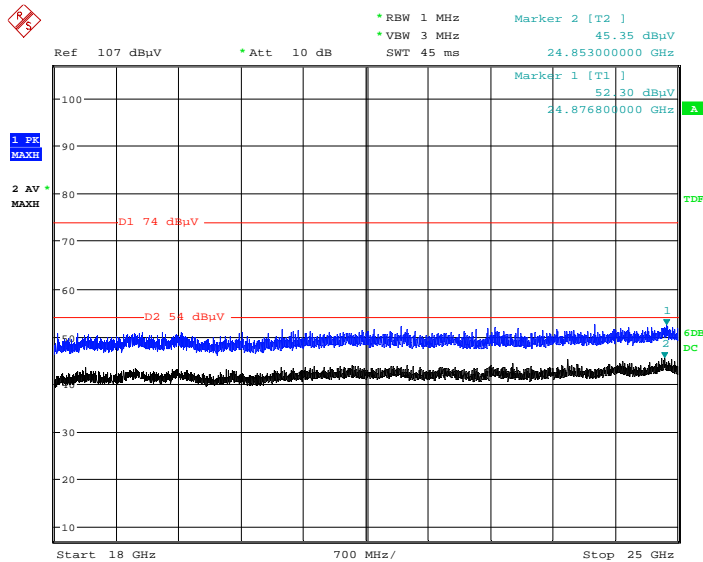

Date: 31.JUL.2020 09:52:17

Restricted Bands Emissions:

Pre-Scan with GFSK, π/4-DQPSK, 8DPSK modes of operation in the X,Y and Z axes of orientation, the worst case GFSK Mode in X-axis of orientation was recorded

Note:

1. Corrected Factor (dB/m) = Antenna factor (RX) (dB/m) + Cable Loss (dB) – Amplifier Factor (dB)

Corrected Amplitude (dBμV/m) = Corrected Factor (dB/m) + Reading (dBμV)

Margin (dB) = Limit (dBμV/m) – Corrected Amplitude (dBμV/m)

Frequency (MHz)	Corrected Amplitude		Rx Antenna		Turntable Degree	Corrected Factor (dB/m)	Limit (dBμV/m)	Margin (dB)
	MaxPeak (dBμV/m)	Average (dBμV/m)	Height (cm)	Polar (H/V)				
Low Channel: 2402MHz								
2390.000000	---	36.59	150.0	V	334.0	-2.9	54.00	17.41
2390.000000	44.13	---	150.0	V	344.0	-2.9	74.00	29.87
High Channel: 2480MHz								
2483.500000	46.26	---	150.0	V	279.0	-2.5	74.00	27.74
2483.500000	---	37.53	150.0	V	279.0	-2.5	54.00	16.47

Conducted Spurious Emissions at Antenna Port

BDR (GFSK): Low Channel

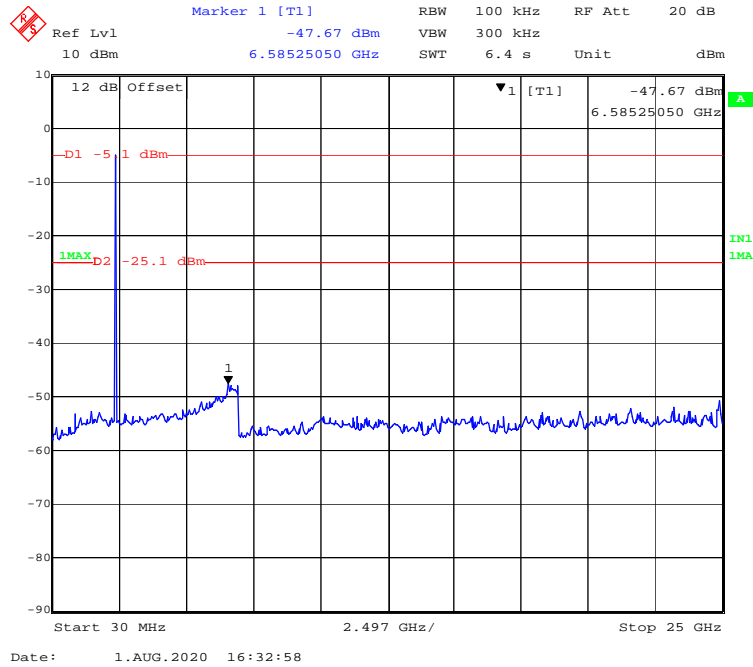

BDR (GFSK): Middle Channel

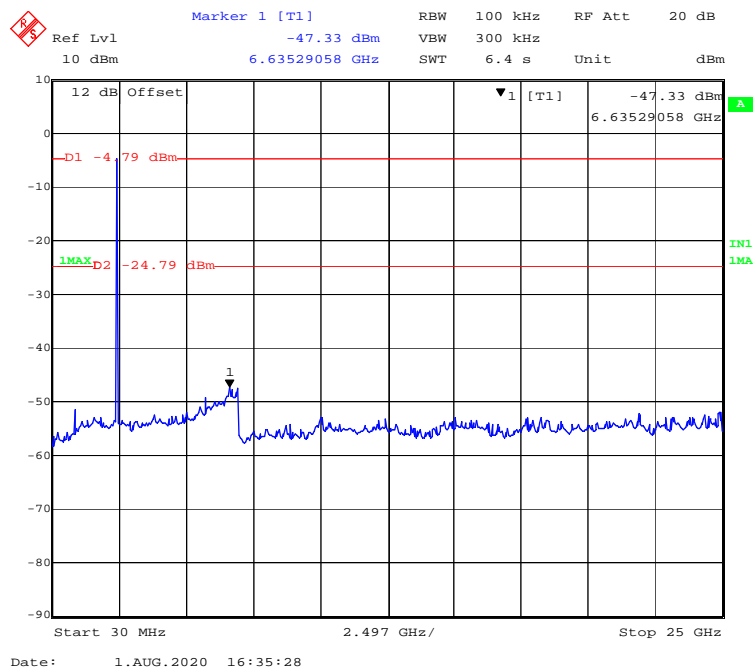

BDR (GFSK): High Channel

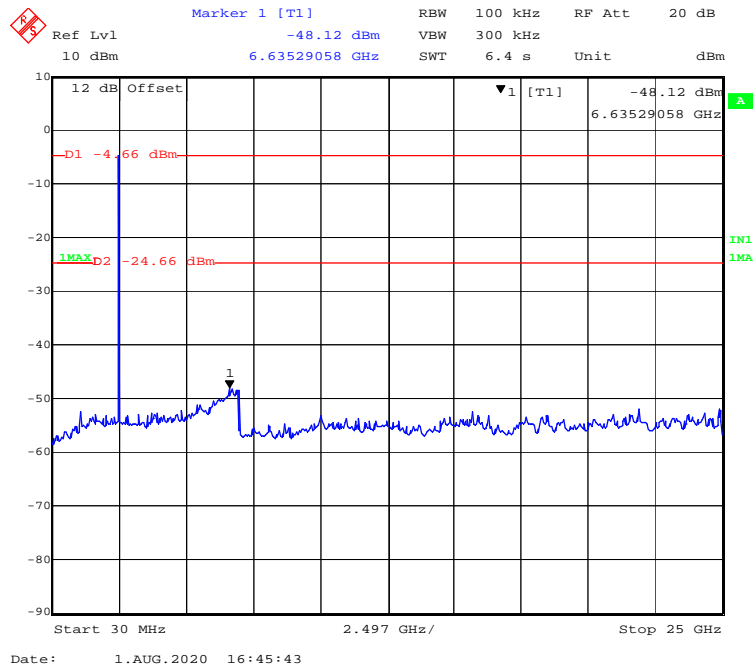

EDR ($\pi/4$ -DQPSK): Low Channel

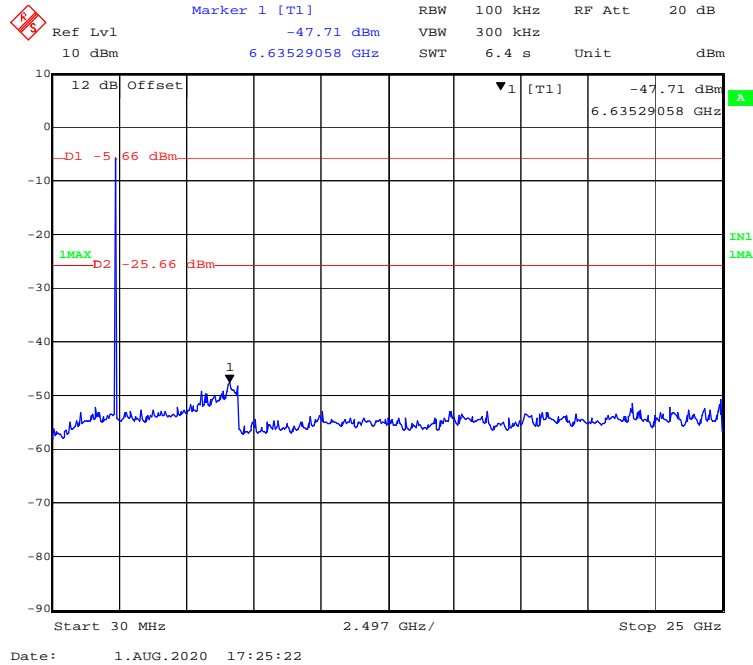

EDR ($\pi/4$ -DQPSK): Middle Channel

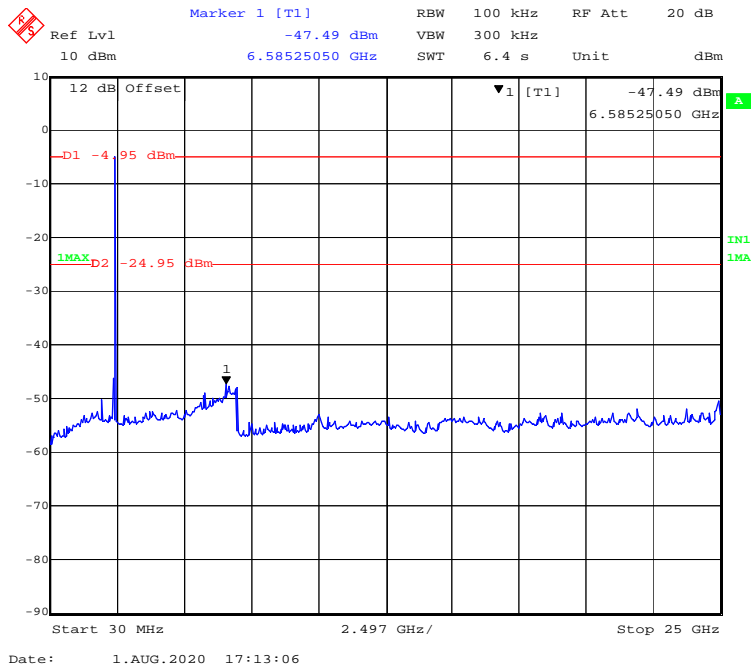

EDR ($\pi/4$ -DQPSK): High Channel

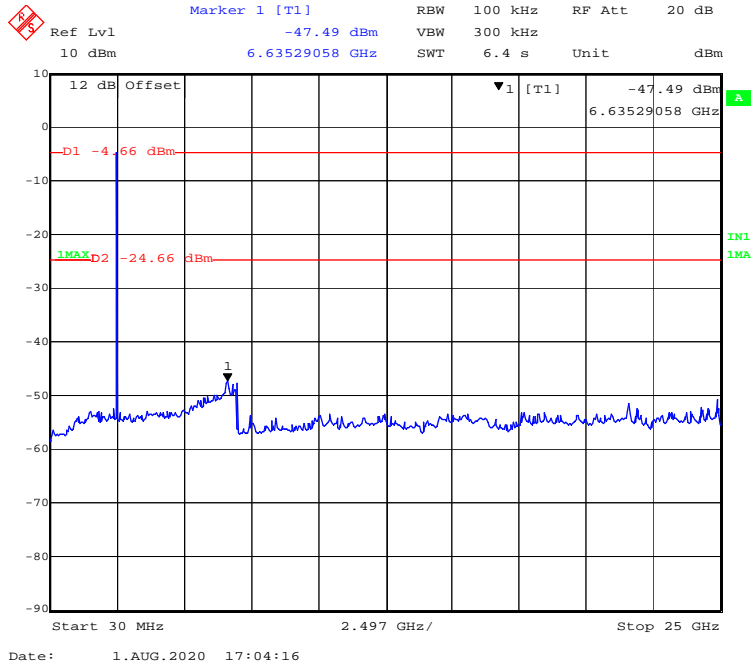

EDR (8DPSK): Low Channel

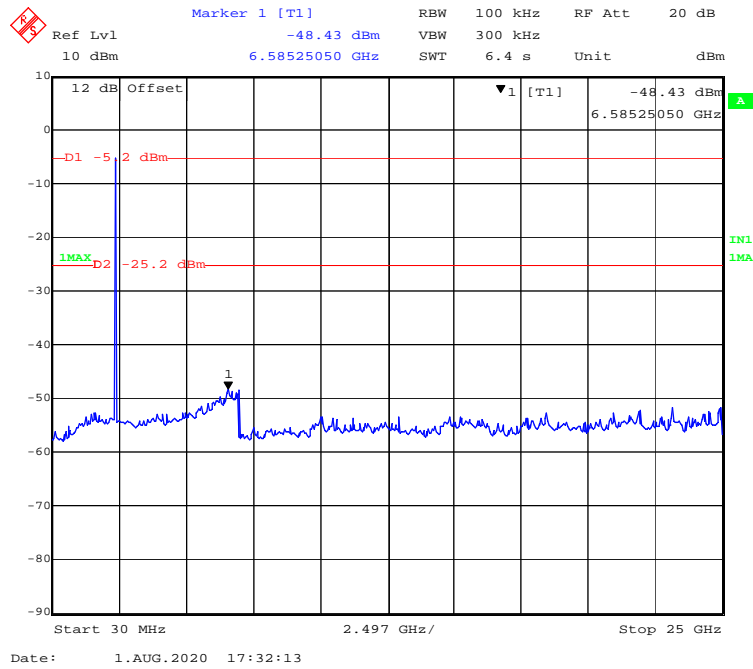

EDR (8DPSK): Middle Channel

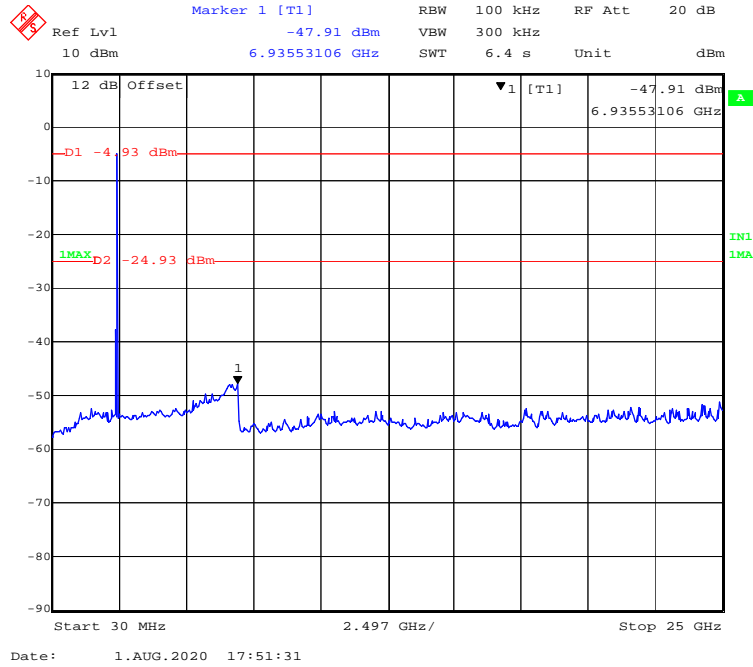

EDR (8DPSK): High Channel

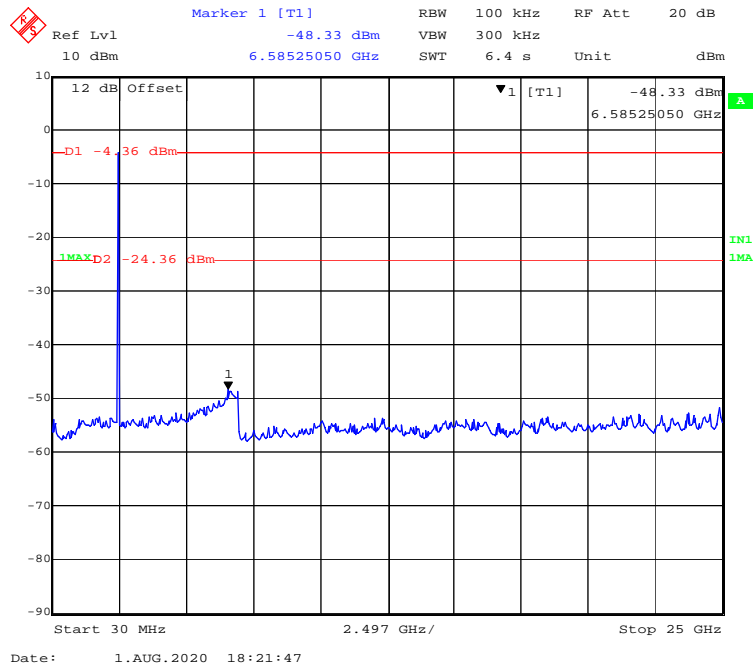

FCC §15.247(a) (1)-CHANNEL SEPARATION TEST

Applicable Standard

Frequency hopping systems shall have hopping channel carrier frequencies separated by a minimum of 25 kHz or the 20 dB bandwidth of the hopping channel, whichever is greater. Alternatively, frequency hopping systems operating in the 2400-2483.5 MHz band may have hopping channel carrier frequencies that are separated by 25 kHz or two-thirds of the 20 dB bandwidth of the hopping channel, whichever is greater provided the systems operate with an output power no greater than 125 mW.

Test Procedure

The EUT shall have its hopping function enabled. Use the following spectrum analyzer settings:

- a. Span: Wide enough to capture the peaks of two adjacent channels.
- b. RBW: Start with the RBW set to approximately 30% of the channel spacing; adjust as necessary to best identify the center of each individual channel.
- c. Video (or average) bandwidth (VBW) \geq RBW.
- d. Sweep: Auto.
- e. Detector function: Peak.
- f. Trace: Max hold.
- g. Allow the trace to stabilize.

Use the marker-delta function to determine the separation between the peaks of the adjacent channels.

Test Data

Environmental Conditions

Temperature:	26.3 °C
Relative Humidity:	69 %
ATM Pressure:	101.3 kPa

The testing was performed by Chao Gao on 2020-08-03.

EUT operation mode: Transmitting

Test Result: Compliant.

Mode	Channel	Frequency (MHz)	Channel Separation (MHz)	Limit (MHz)	Result
BDR (GFSK)	Low	2402	1.003	0.753	Pass
	Adjacent	2403			
	Middle	2441	1.003	0.753	Pass
	Adjacent	2442			
	High	2480	1.003	0.753	Pass
	Adjacent	2479			
EDR ($\pi/4$ -DQPSK)	Low	2402	0.999	0.801	Pass
	Adjacent	2403			
	Middle	2441	0.999	0.797	Pass
	Adjacent	2442			
	High	2480	0.999	0.801	Pass
	Adjacent	2479			
EDR (8DPSK)	Low	2402	0.999	0.825	Pass
	Adjacent	2403			
	Middle	2441	0.999	0.825	Pass
	Adjacent	2442			
	High	2480	0.999	0.825	Pass
	Adjacent	2479			

Note: For BDR and EDR mode, Limit = 20 dB bandwidth*2/3

BDR (GFSK): Low Channel



BDR (GFSK): Middle Channel

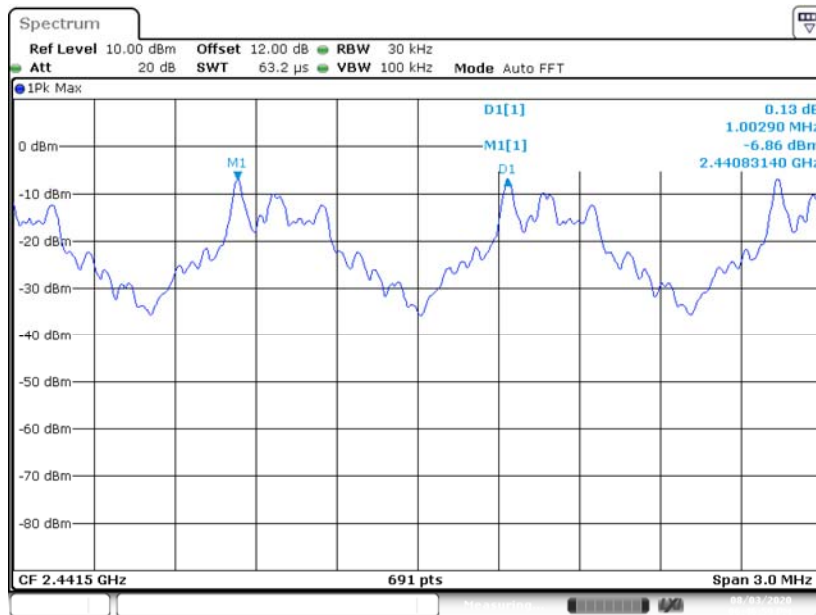

Date: 3.AUG.2020 18:47:00

BDR (GFSK): High Channel



Date: 3.AUG.2020 18:48:10

EDR ($\pi/4$ -DQPSK): Low Channel

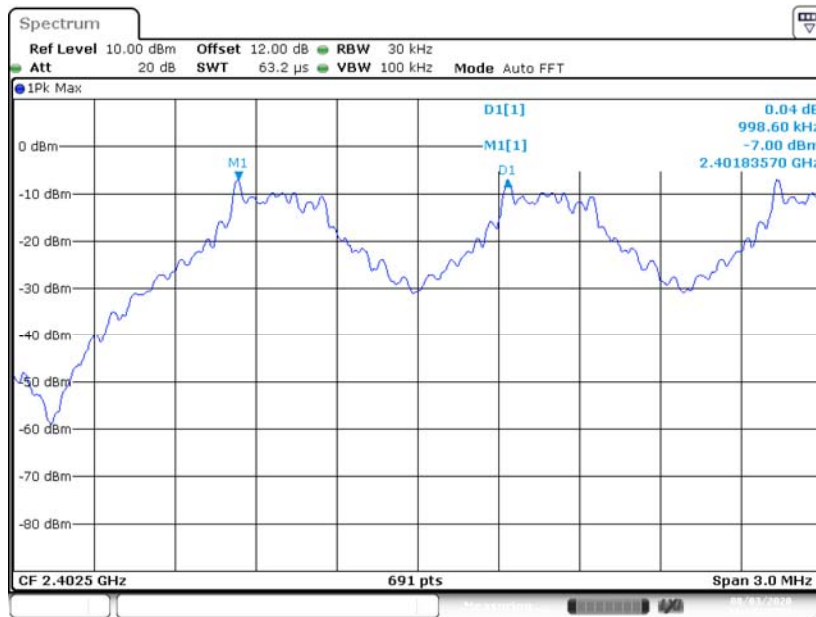

EDR ($\pi/4$ -DQPSK): Middle Channel

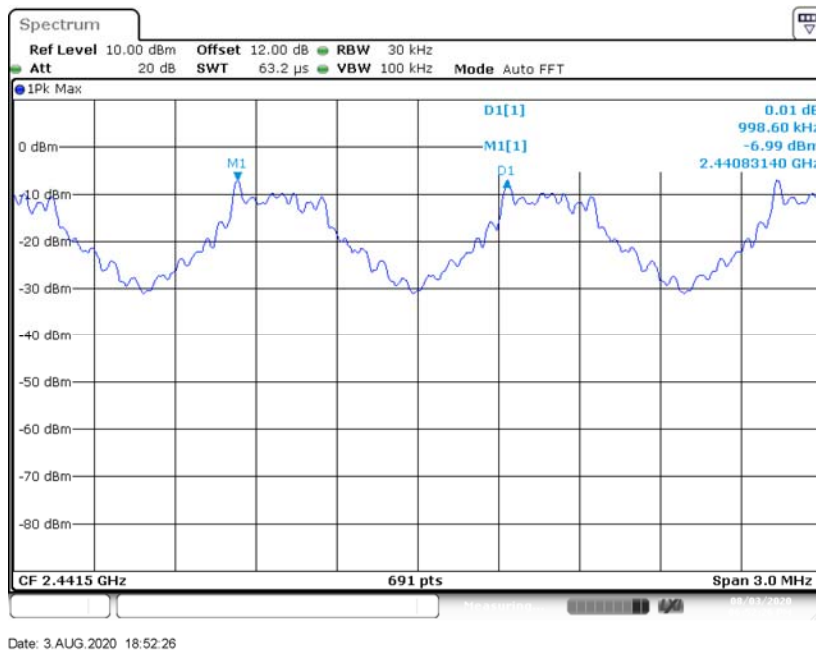

EDR ($\pi/4$ -DQPSK): High Channel

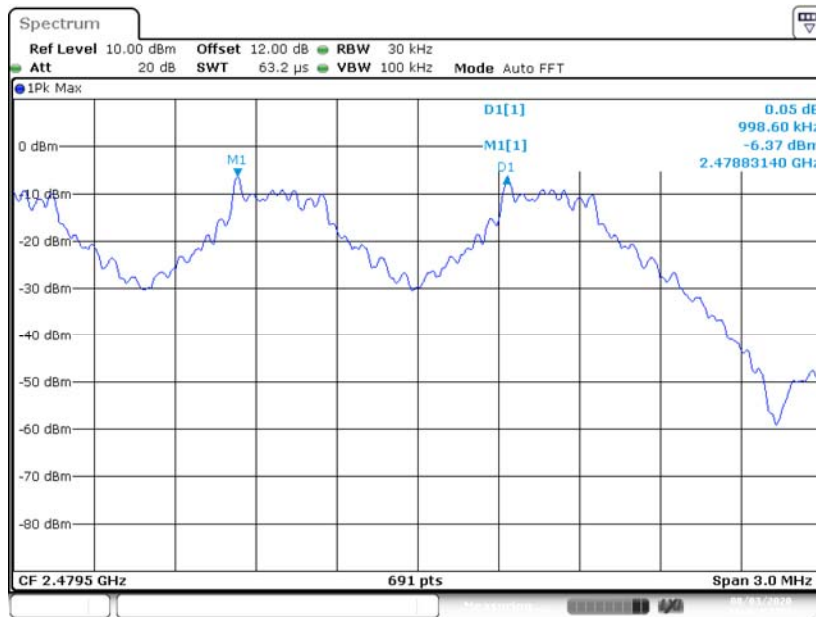

Date: 3.AUG.2020 18:49:54

EDR (8DPSK): Low Channel

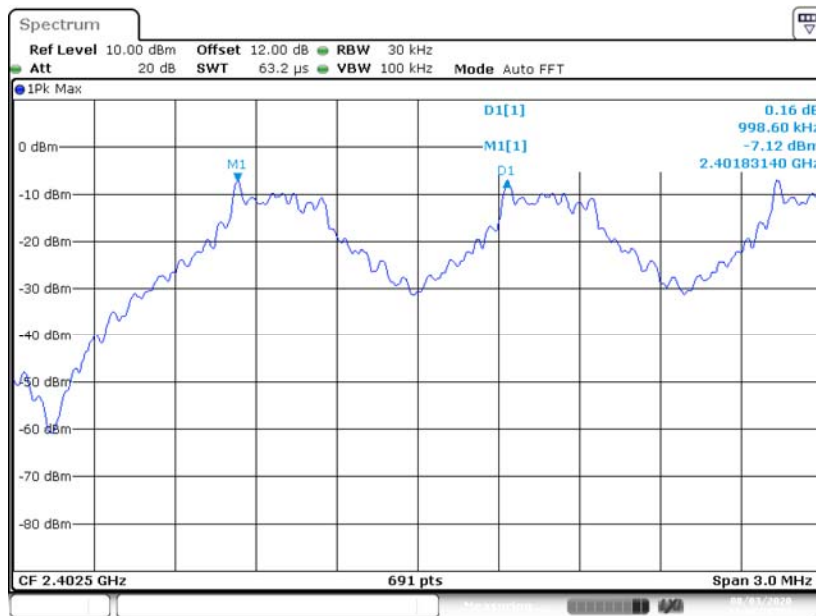

Date: 3.AUG.2020 19:05:26

EDR (8DPSK): Middle Channel

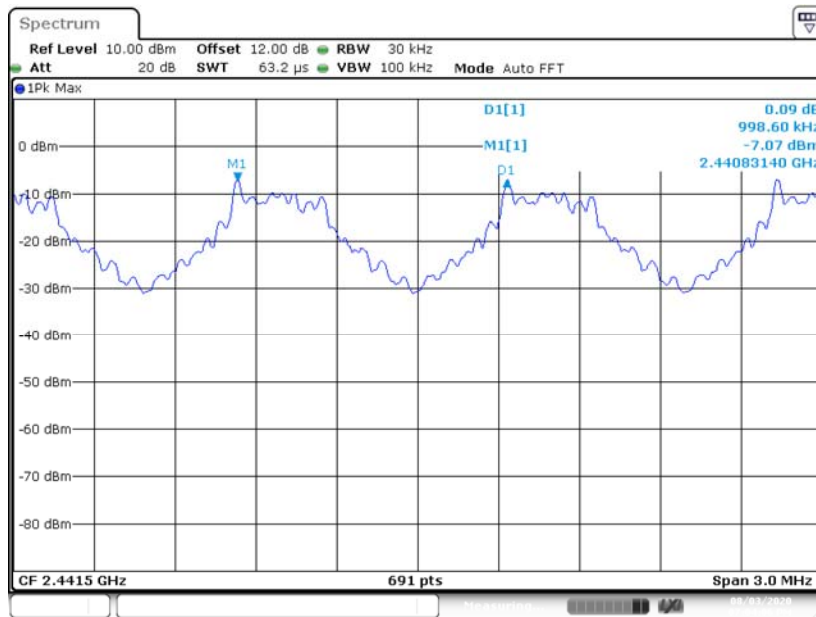

Date: 3.AUG.2020 19:04:06

EDR (8DPSK): High Channel

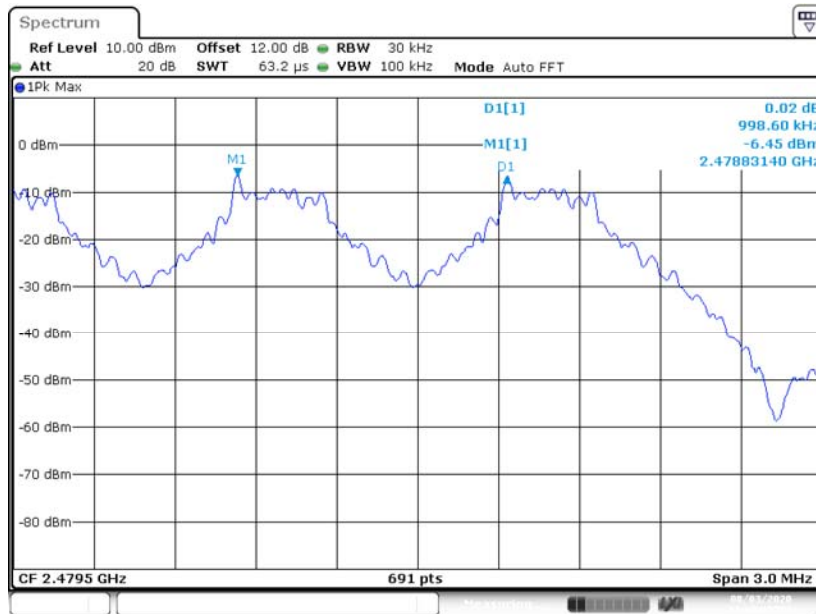

Date: 3.AUG.2020 19:02:09

FCC §15.247(a) (1) – 20 dB EMISSION BANDWIDTH

Applicable Standard

Alternatively, frequency hopping systems operating in the 2400–2483.5 MHz band may have hopping channel carrier frequencies that are separated by 25 kHz or two-thirds of the 20 dB bandwidth of the hopping channel, whichever is greater, provided the systems operate with an output power no greater than 125 mW.

Test Procedure

1. Check the calibration of the measuring instrument using either an internal calibrator or a known signal from an external generator.
2. Position the EUT without connection to measurement instrument. Turn on the EUT and connect it to measurement instrument. Then set it to any one convenient frequency within its operating range. Set a reference level on the measuring instrument equal to the highest peak value.
3. Measure the frequency difference of two frequencies that were attenuated 20 dB from the reference level. Record the frequency difference as the emission bandwidth.
4. Repeat above procedures until all frequencies measured were complete.

Test Data

Environmental Conditions

Temperature:	26.7 °C
Relative Humidity:	61 %
ATM Pressure:	101.3 kPa

The testing was performed by Chao Gao on 2020-08-01.

EUT operation mode: Transmitting

Test Result: Compliant.

Mode	Channel	Frequency (MHz)	20 dB Emission Bandwidth (MHz)
BDR (GFSK)	Low	2402	1.130
	Middle	2441	1.130
	High	2480	1.130
EDR ($\pi/4$-DQPSK)	Low	2402	1.202
	Middle	2441	1.196
	High	2480	1.202
EDR (8DPSK)	Low	2402	1.238
	Middle	2441	1.238
	High	2480	1.238

BDR (GFSK): Low Channel

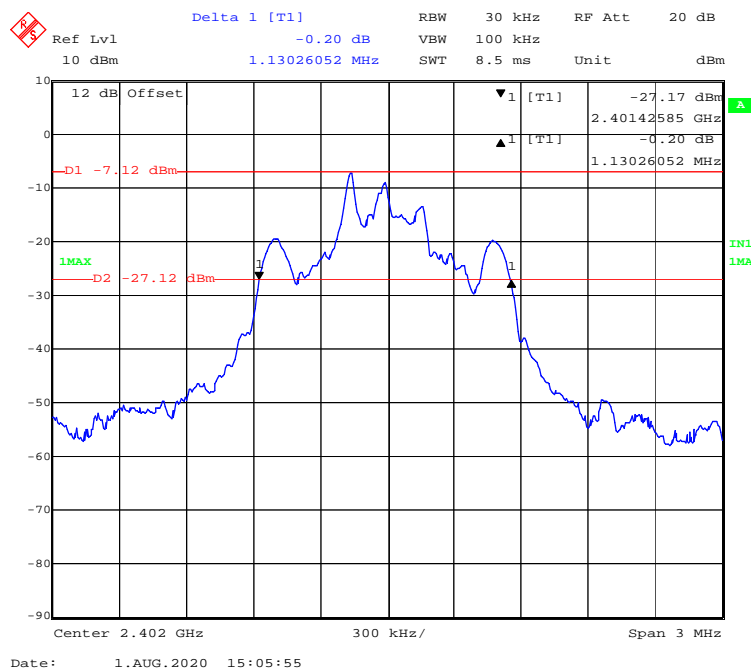

BDR (GFSK): Middle Channel

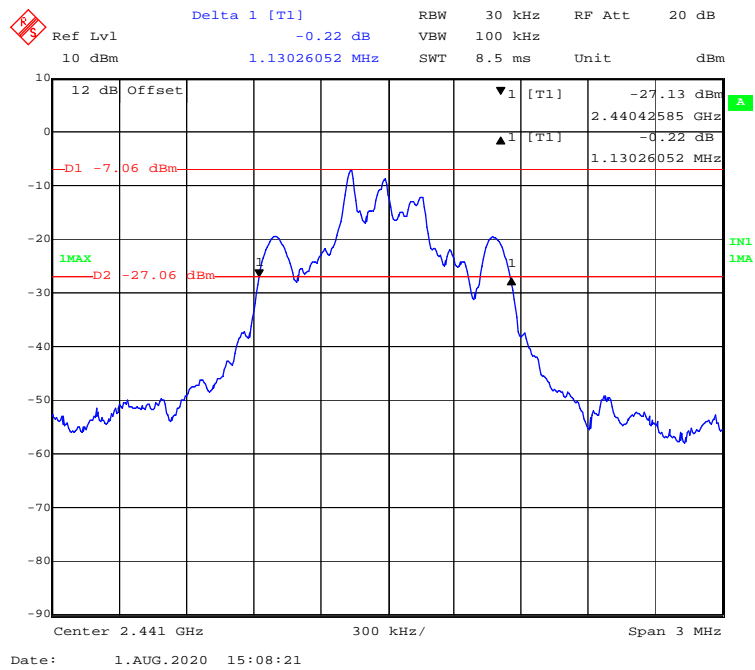

BDR (GFSK): High Channel

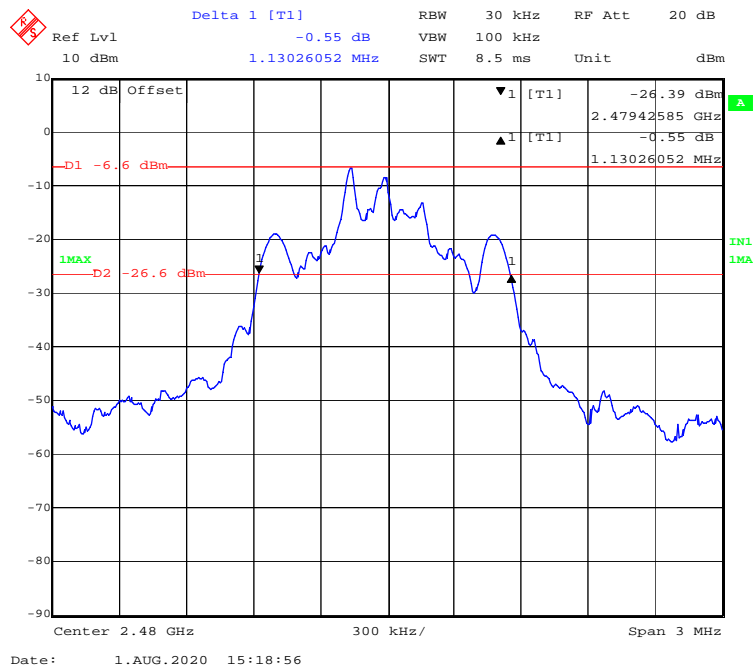

EDR ($\pi/4$ -DQPSK): Low Channel

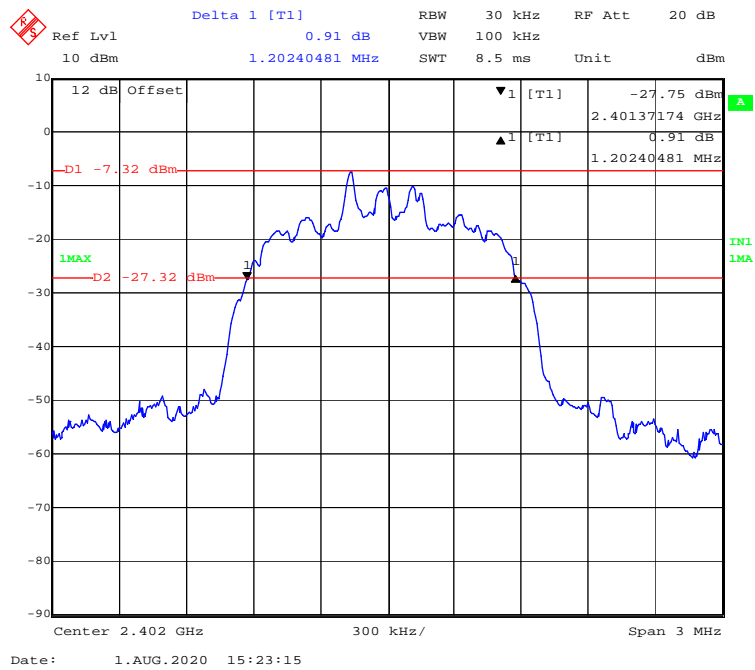

EDR($\pi/4$ -DQPSK): Middle Channel

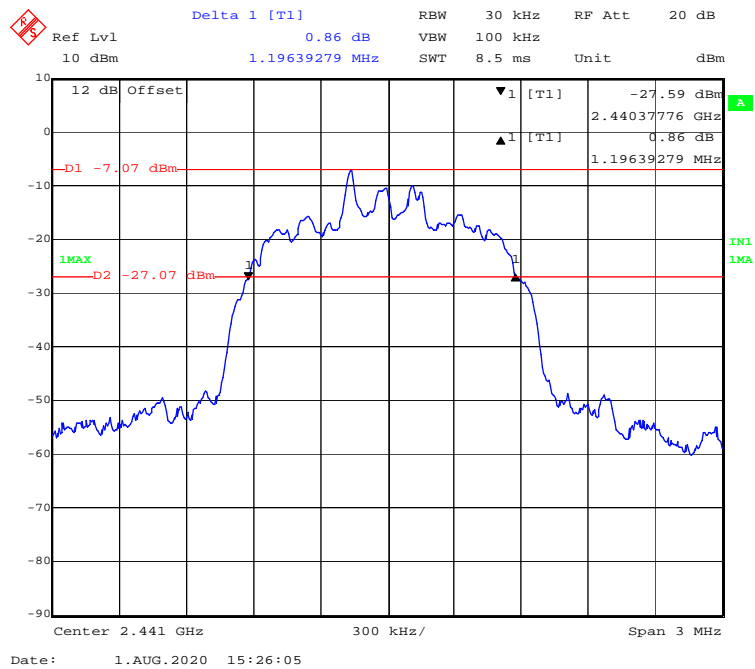

EDR ($\pi/4$ -DQPSK): High Channel

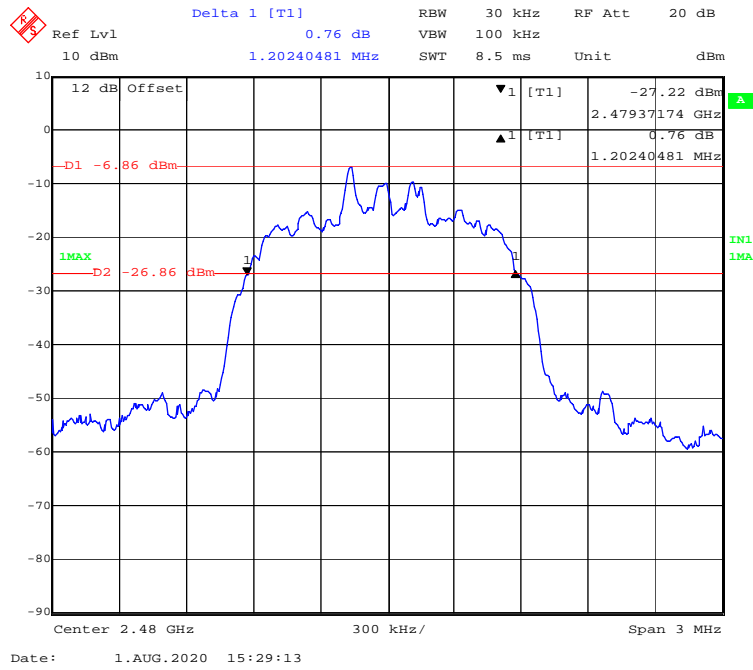

EDR (8DPSK): Low Channel

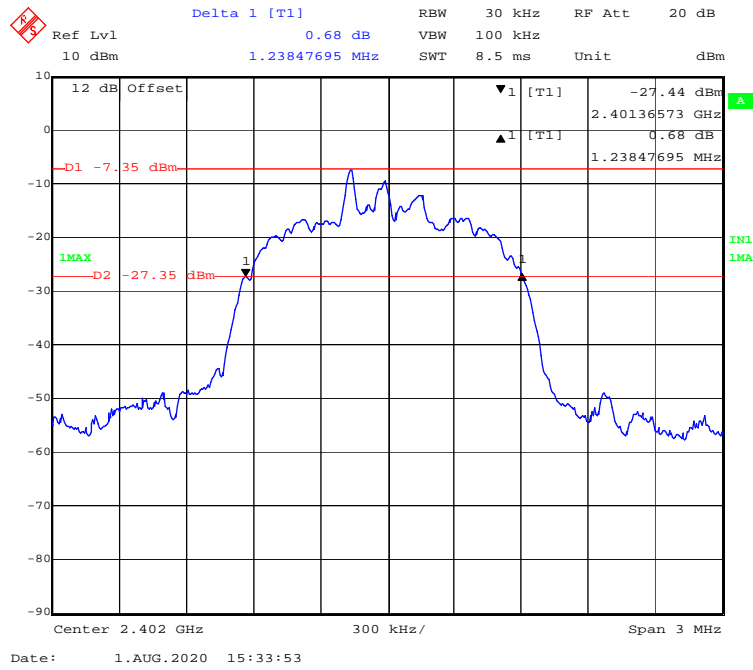

EDR (8DPSK): Middle Channel

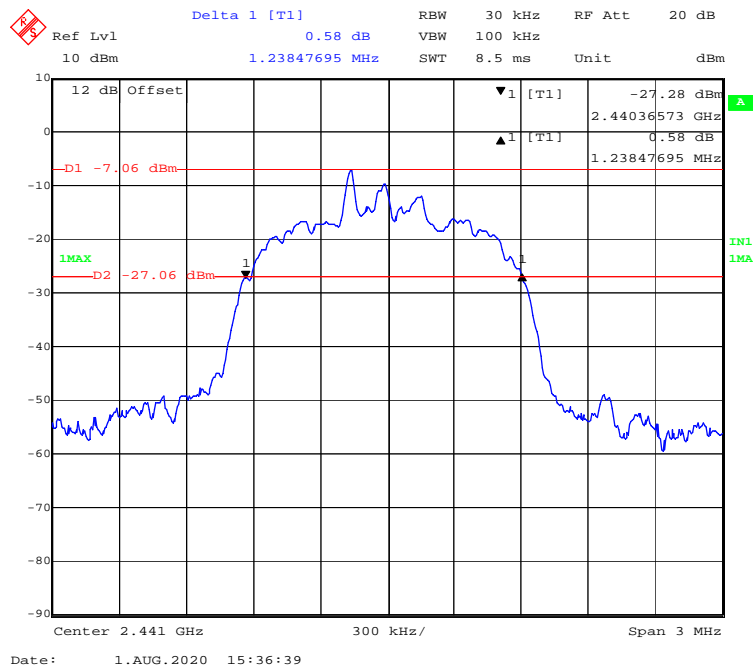

EDR (8DPSK): High Channel

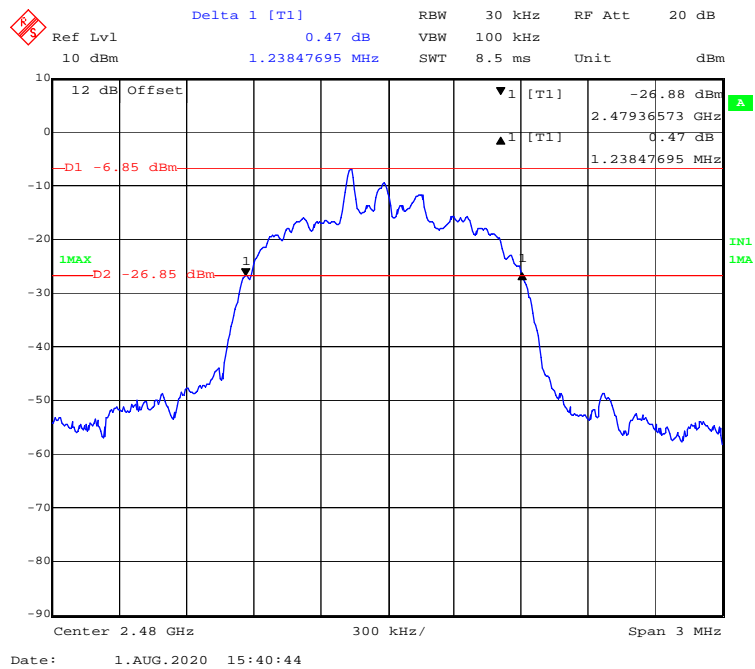

FCC §15.247(a) (1) (iii)-QUANTITY OF HOPPING CHANNEL TEST

Applicable Standard

Frequency hopping systems in the 2400–2483.5 MHz band shall use at least 15 channels. The average time of occupancy on any channel shall not be greater than 0.4 seconds within a period of 0.4 seconds multiplied by the number of hopping channels employed. Frequency hopping systems may avoid or suppress transmissions on a particular hopping frequency provided that a minimum of 15 channels are used.

Test Procedure

The EUT shall have its hopping function enabled. Use the following spectrum analyzer settings:

- a. Span: The frequency band of operation. Depending on the number of channels the device supports, it may be necessary to divide the frequency range of operation across multiple spans, to allow the individual channels to be clearly seen.
- b. RBW: To identify clearly the individual channels, set the RBW to less than 30% of the channel spacing or the 20 dB bandwidth, whichever is smaller.
- c. VBW \geq RBW.
- d. Sweep: Auto.
- e. Detector function: Peak.
- f. Trace: Max hold.
- g. Allow the trace to stabilize.

It might prove necessary to break the span up into subranges to show clearly all of the hopping frequencies.

Test Data

Environmental Conditions

Temperature:	26.7 °C
Relative Humidity:	61 %
ATM Pressure:	101.3 kPa

The testing was performed by Chao Gao on 2020-08-01.

EUT operation mode: Hopping

Test Result: Compliant.

Mode	Frequency Range (MHz)	Number of Hopping Channel (CH)	Limit (CH)
BDR (GFSK)	2400-2483.5	79	≥15
EDR (π/4-DQPSK)	2400-2483.5	79	≥15
EDR (8DPSK)	2400-2483.5	79	≥15

BDR (GFSK): Number of Hopping Channels

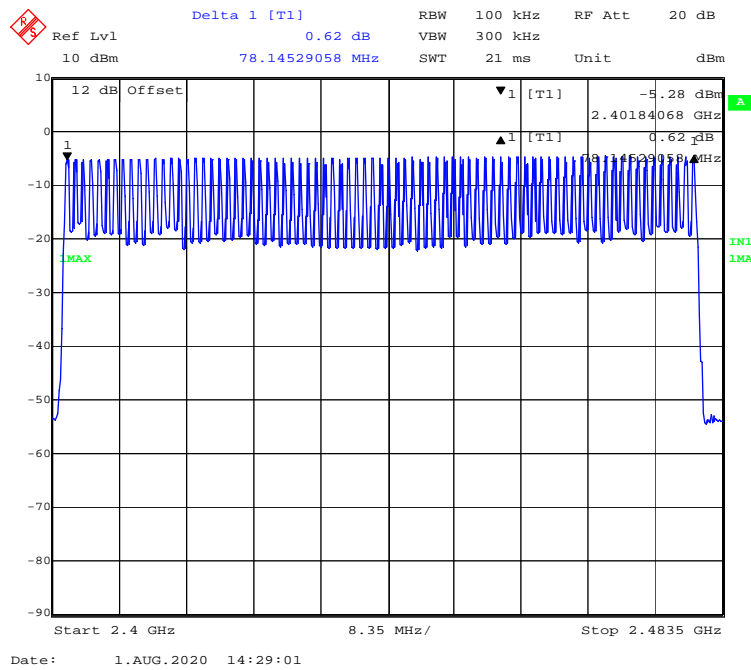

EDR ($\pi/4$ -DQPSK): Number of Hopping Channels

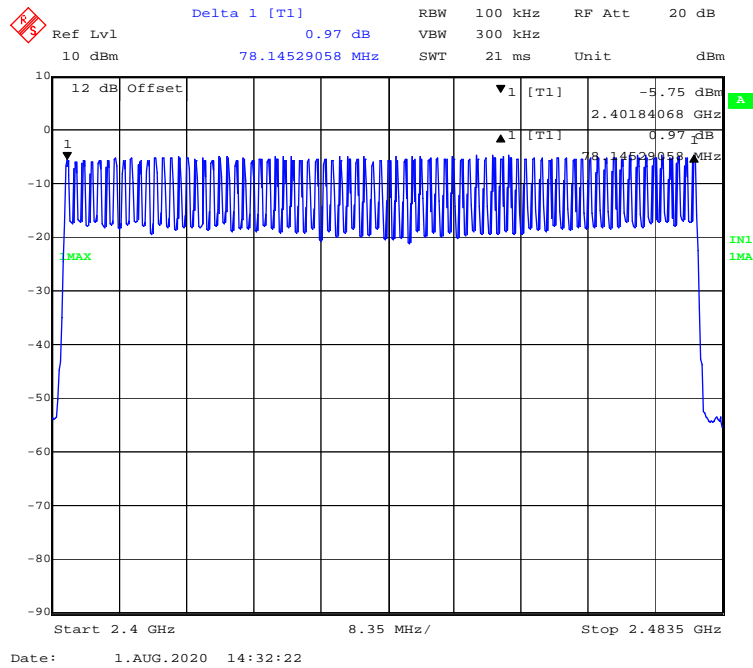

EDR (8DPSK): Number of Hopping Channels

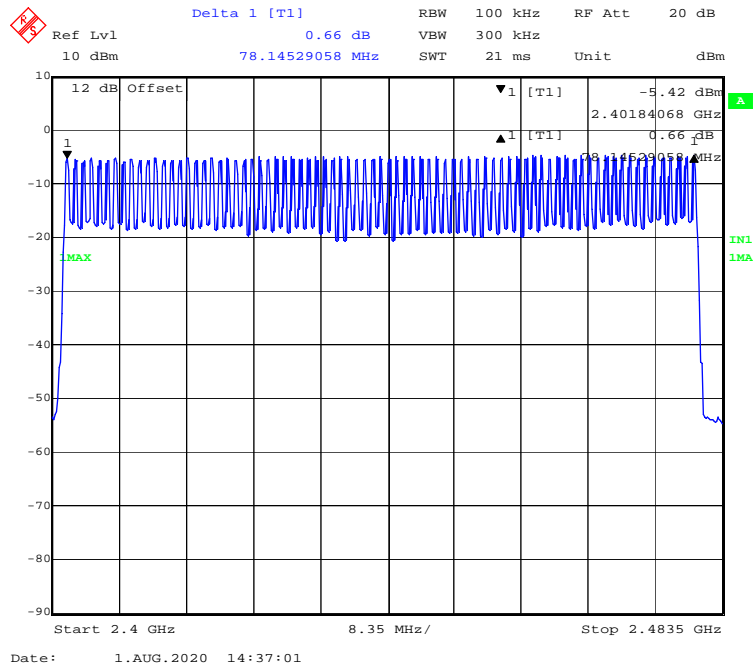

FCC §15.247(a) (1) (iii) - TIME OF OCCUPANCY (DWELL TIME)**Applicable Standard**

Frequency hopping systems in the 2400-2483.5 MHz shall use at least 15 channels. The average time of occupancy on any channel shall not be greater than 0.4 seconds within a period of 0.4 seconds multiplied by the number of hopping channels employed. Frequency hopping systems may avoid or suppress transmissions on a particular hopping frequency provided that a minimum of 15 channels are used.

Test Procedure

The EUT shall have its hopping function enabled. Use the following spectrum analyzer settings:

- a Span: Zero span, centered on a hopping channel.
- b RBW shall be \leq channel spacing and where possible RBW should be set $\geq 1 / T$, where T is the expected dwell time per channel.
- c Sweep: As necessary to capture the entire dwell time per hopping channel; where possible use a video trigger and trigger delay so that the transmitted signal starts a little to the right of the start of the plot. The trigger level might need slight adjustment to prevent triggering when the system hops on an adjacent channel; a second plot might be needed with a longer sweep time to show two successive hops on a channel.
- d Detector function: Peak.
- e Trace: Max hold.

Test Data**Environmental Conditions**

Temperature:	26.3 °C
Relative Humidity:	69 %
ATM Pressure:	101.3 kPa

The testing was performed by Chao Gao on 2020-08-03.

EUT operation mode: Hopping

Test Result: Compliant.

Mode		Channel	Pulse Width (ms)	Dwell Time (s)	Limit (s)	Result	
BDR (GFSK)	DH1	Low	0.389	0.124	0.4	Pass	
		Middle	0.395	0.126	0.4	Pass	
		High	0.389	0.124	0.4	Pass	
	Note: DH1:Dwell time = Pulse time*(1600/2/79)*31.6S						
	DH3	Low	1.680	0.269	0.4	Pass	
		Middle	1.653	0.264	0.4	Pass	
		High	1.665	0.266	0.4	Pass	
	Note: DH3:Dwell time = Pulse time*(1600/4/79)*31.6S						
	DH5	Low	2.926	0.312	0.4	Pass	
		Middle	2.926	0.312	0.4	Pass	
		High	2.926	0.312	0.4	Pass	
	Note: DH5:Dwell time = Pulse time*(1600/6/79)*31.6S						
EDR (π/4-DQPSK)	2DH1	Low	0.403	0.129	0.4	Pass	
		Middle	0.401	0.128	0.4	Pass	
		High	0.407	0.130	0.4	Pass	
	Note: 2DH1:Dwell time = Pulse time*(1600/2/79)*31.6S						
	2DH3	Low	1.665	0.266	0.4	Pass	
		Middle	1.677	0.268	0.4	Pass	
		High	1.683	0.269	0.4	Pass	
	Note: 2DH3:Dwell time = Pulse time*(1600/4/79)*31.6S						
	2DH5	Low	2.926	0.312	0.4	Pass	
		Middle	2.934	0.313	0.4	Pass	
		High	2.918	0.311	0.4	Pass	
	Note: 2DH5:Dwell time = Pulse time*(1600/6/79)*31.6S						
EDR (8DPSK)	3DH1	Low	0.405	0.130	0.4	Pass	
		Middle	0.403	0.129	0.4	Pass	
		High	0.403	0.129	0.4	Pass	
	Note:3 DH1:Dwell time = Pulse time*(1600/2/79)*31.6S						
	3DH3	Low	1.683	0.269	0.4	Pass	
		Middle	1.665	0.266	0.4	Pass	
		High	1.677	0.268	0.4	Pass	
	Note: 3DH3:Dwell time = Pulse time*(1600/4/79)*31.6S						
	3DH5	Low	2.918	0.311	0.4	Pass	
		Middle	2.942	0.314	0.4	Pass	
		High	2.942	0.314	0.4	Pass	
	Note: 3DH5:Dwell time = Pulse time*(1600/6/79)*31.6S						

BDR (GFSK): Pulse time, Low Channel, DH1

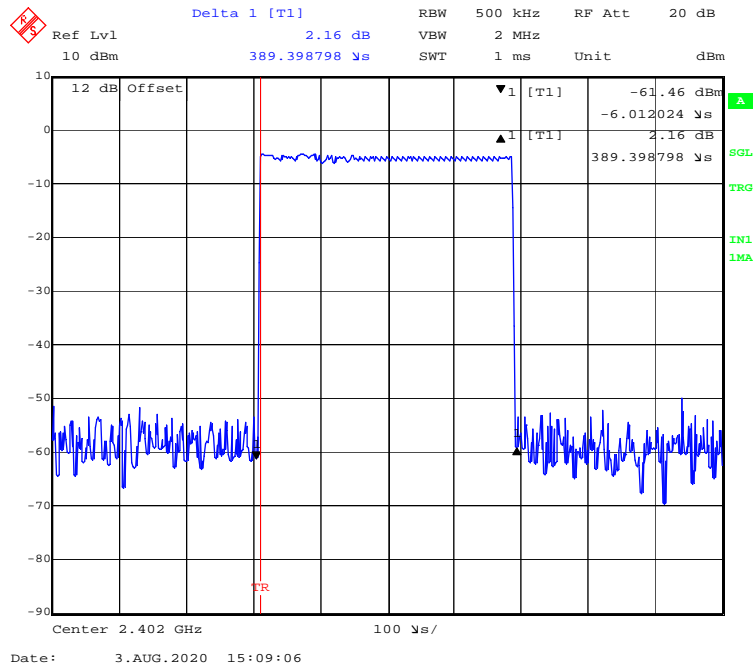

BDR (GFSK): Pulse time, Middle Channel, DH1

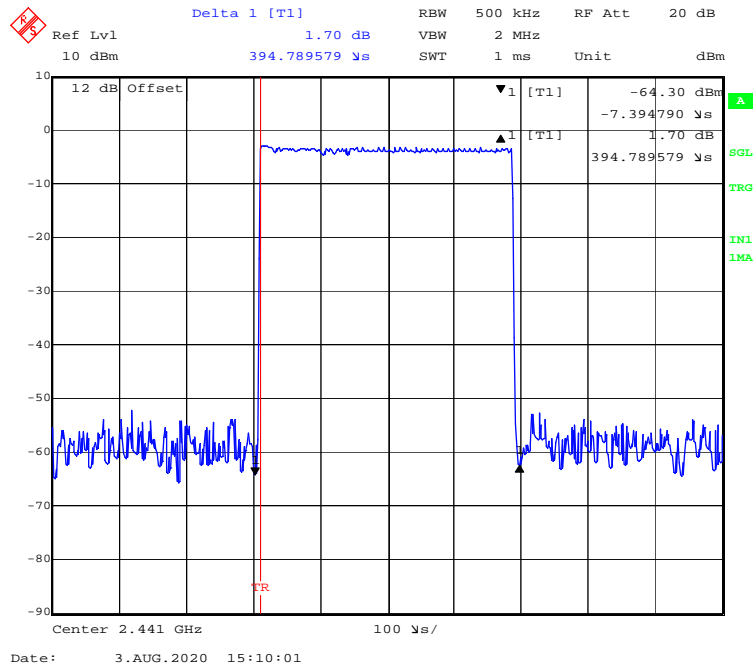

BDR (GFSK): Pulse time, High Channel, DH1

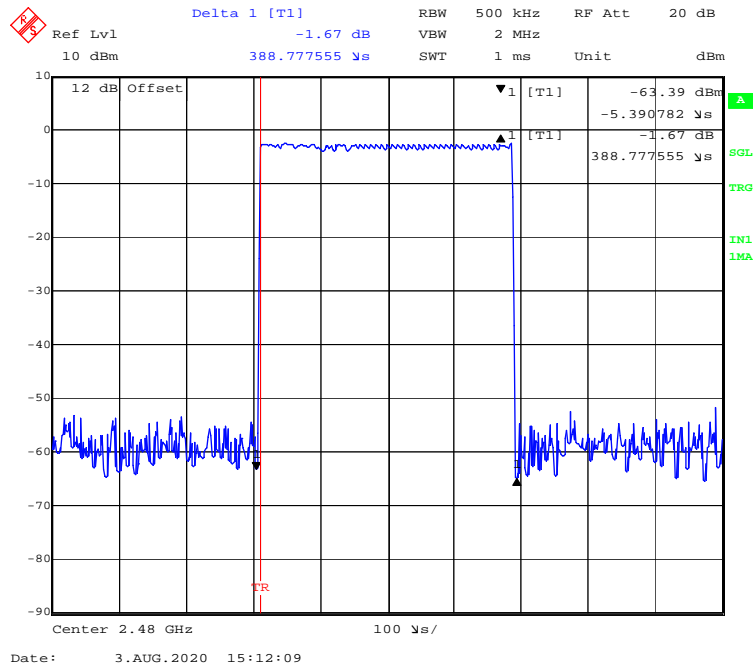

BDR (GFSK): Pulse time, Low Channel, DH3

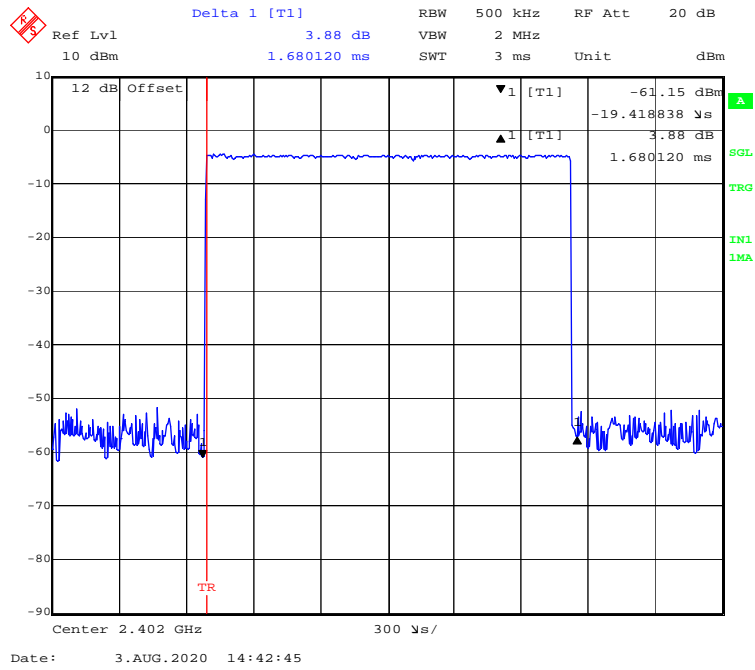

BDR (GFSK): Pulse time, Middle Channel, DH3

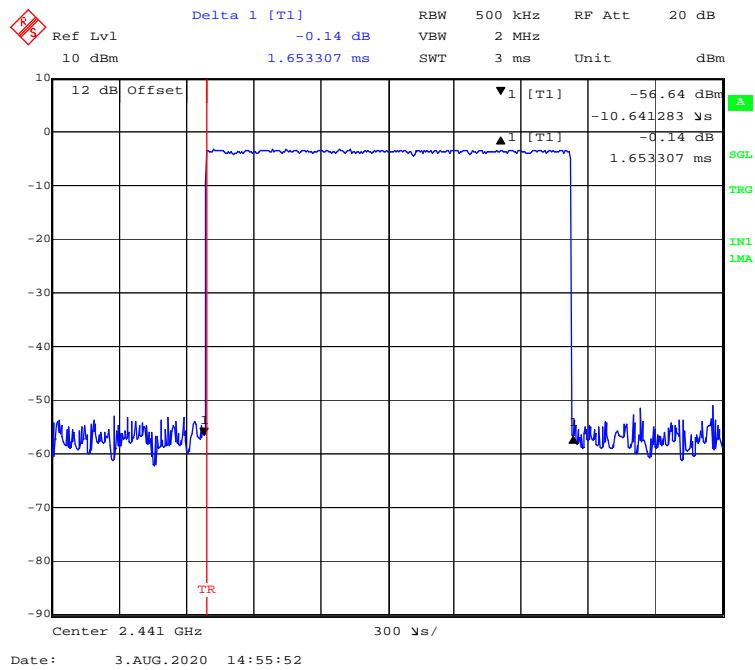

BDR (GFSK): Pulse time, High Channel, DH3

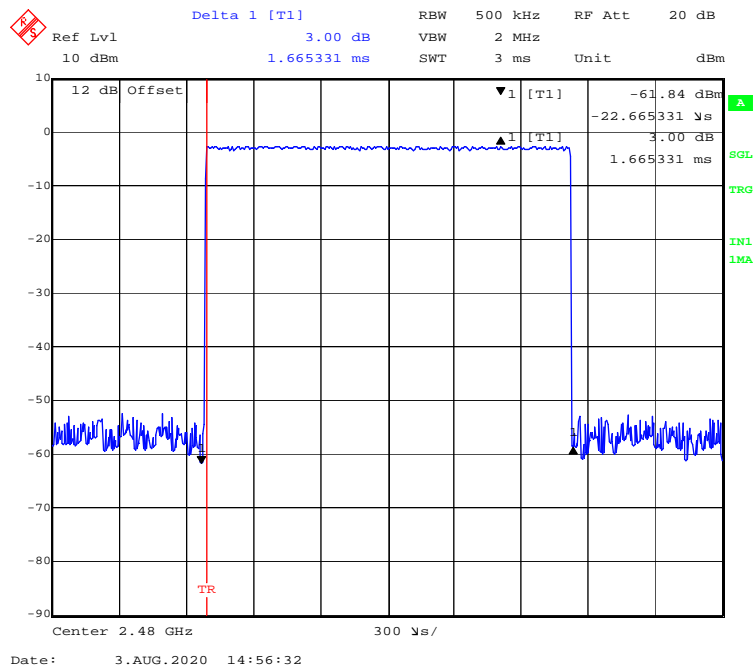

BDR (GFSK): Pulse time, Low Channel, DH5

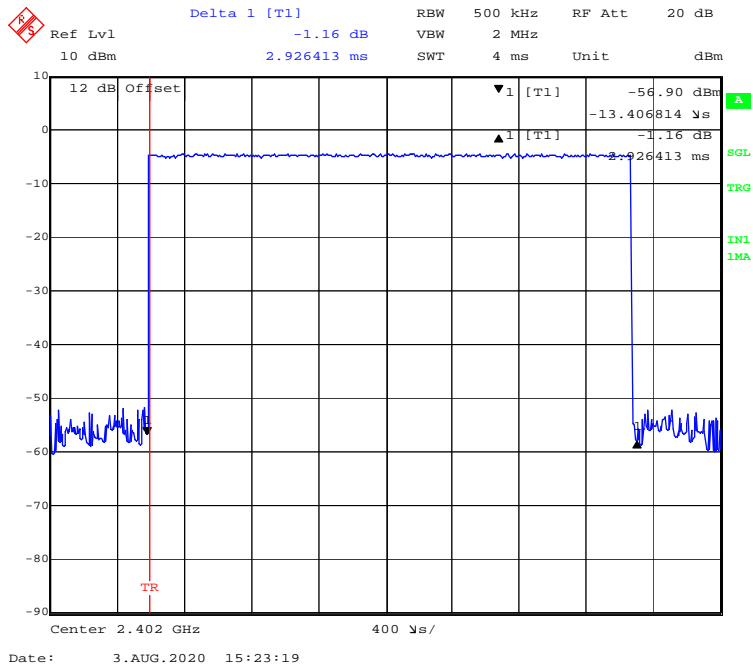

BDR (GFSK): Pulse time, Middle Channel, DH5

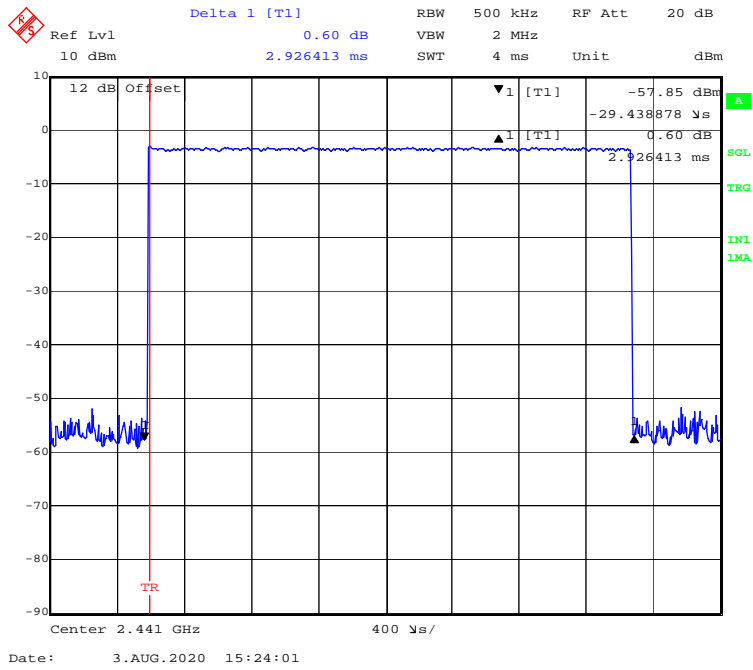

BDR (GFSK): Pulse time, High Channel, DH5

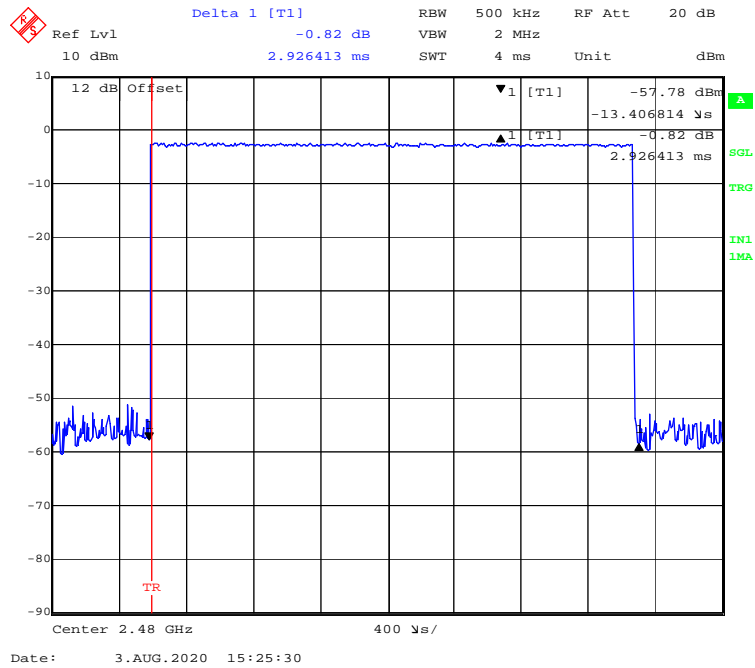

EDR ($\pi/4$ -DQPSK): Pulse time, Low Channel, 2DH1

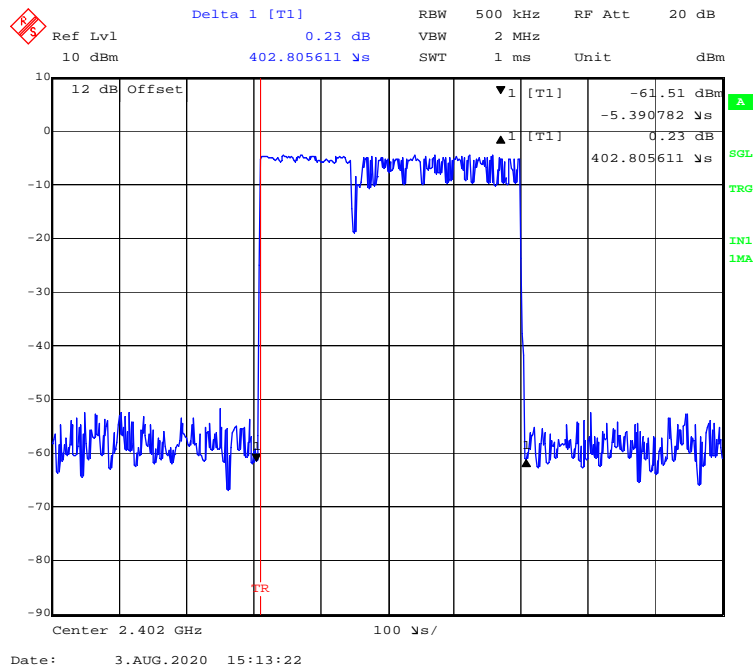

EDR ($\pi/4$ -DQPSK):Pulse time, Middle Channel, 2DH1

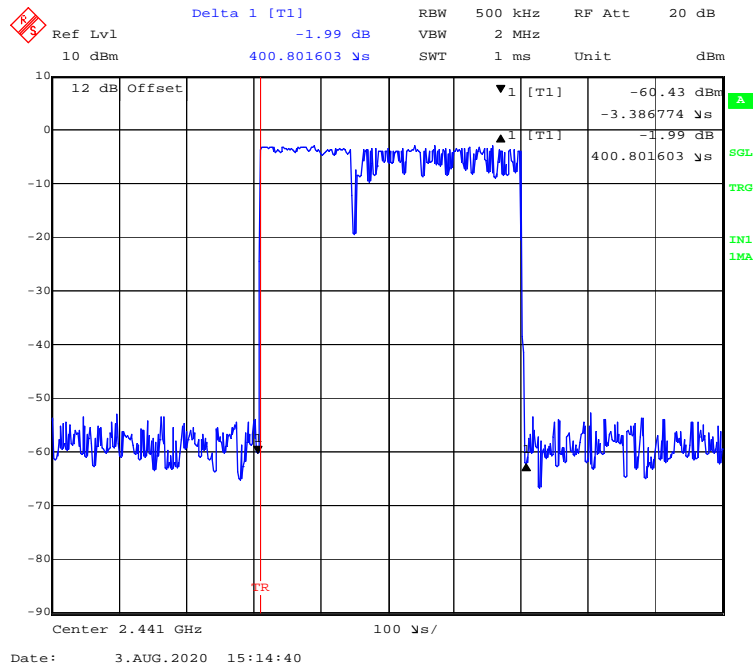

EDR ($\pi/4$ -DQPSK):Pulse time, High Channel, 2DH1

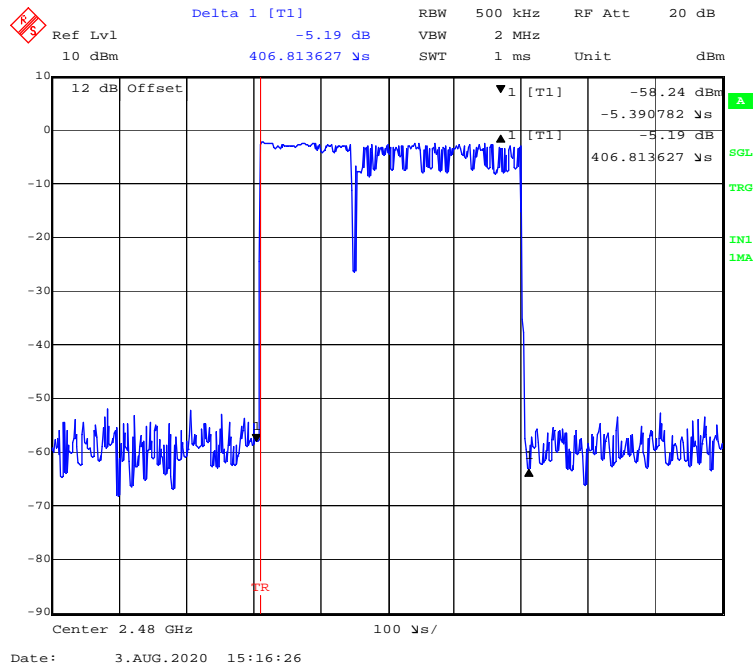

EDR ($\pi/4$ -DQPSK):Pulse time, Low Channel, 2DH3

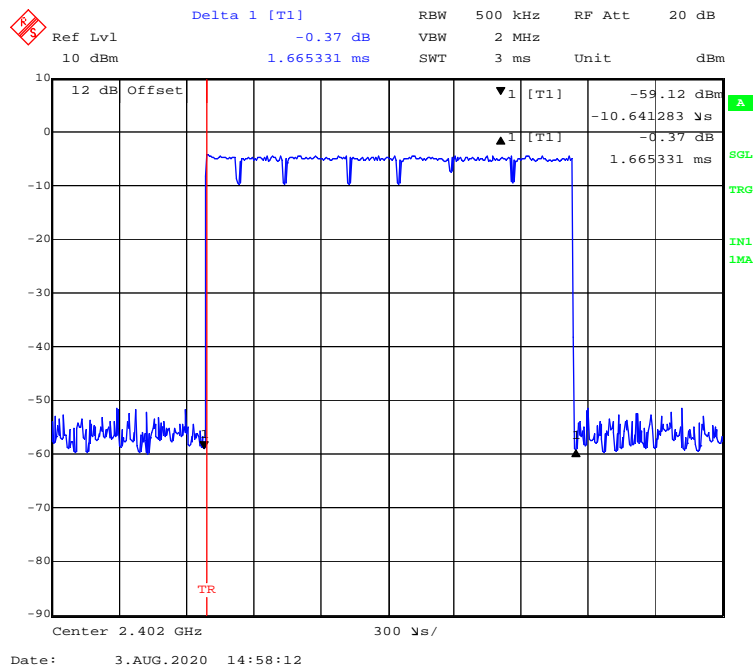

EDR ($\pi/4$ -DQPSK):Pulse time, Middle Channel, 2DH3

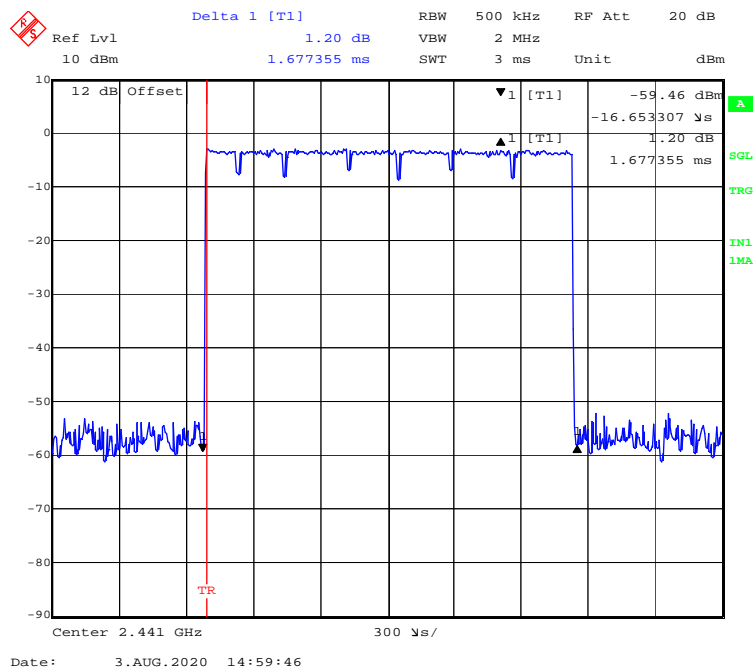

EDR ($\pi/4$ -DQPSK):Pulse time, High Channel, 2DH3

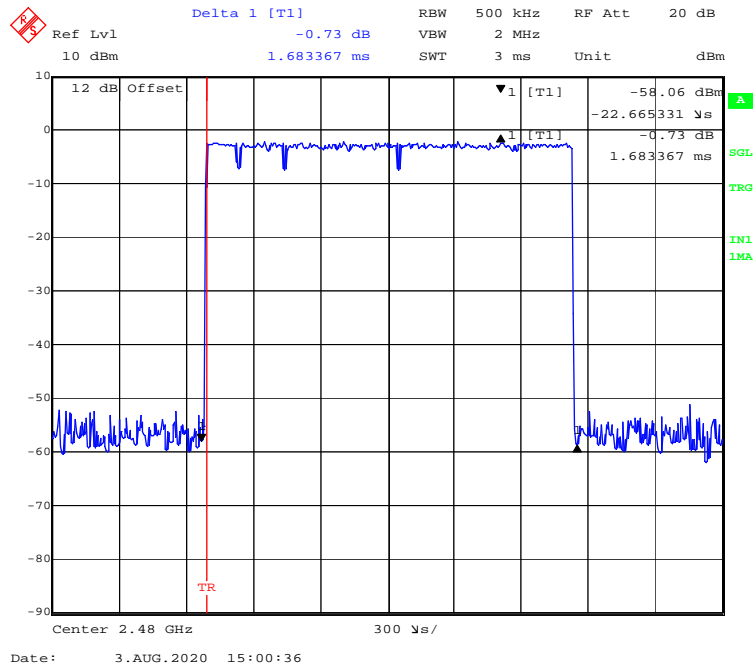

EDR ($\pi/4$ -DQPSK):Pulse time, Low Channel, 2DH5

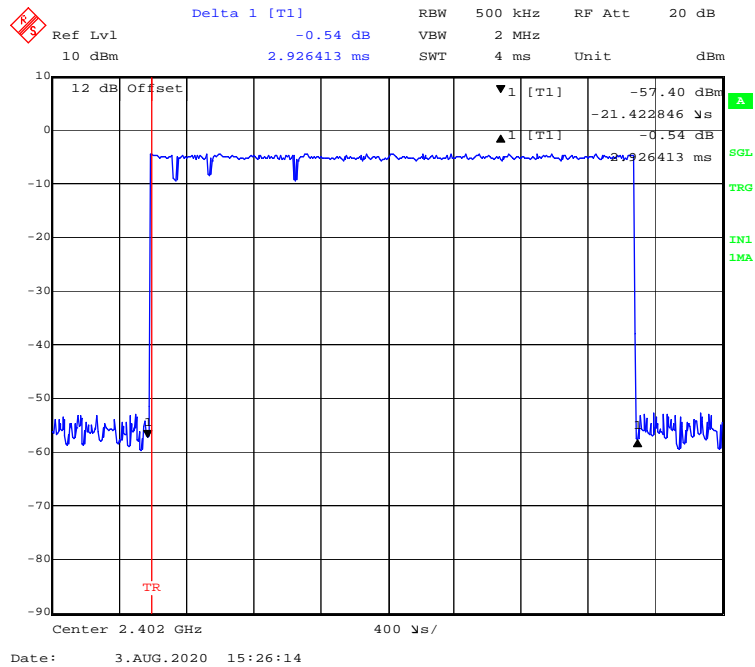

EDR ($\pi/4$ -DQPSK):Pulse time, Middle Channel, 2DH5

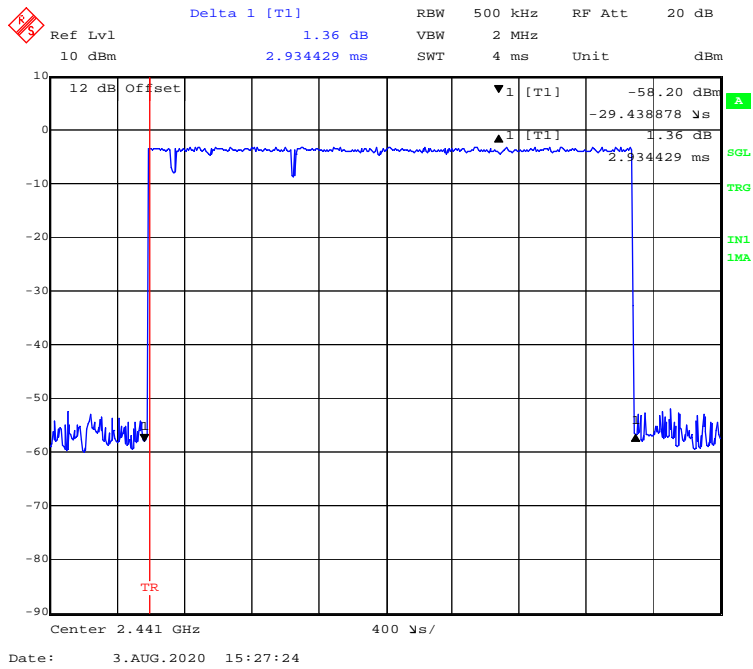

EDR ($\pi/4$ -DQPSK):Pulse time, High Channel, 2DH5

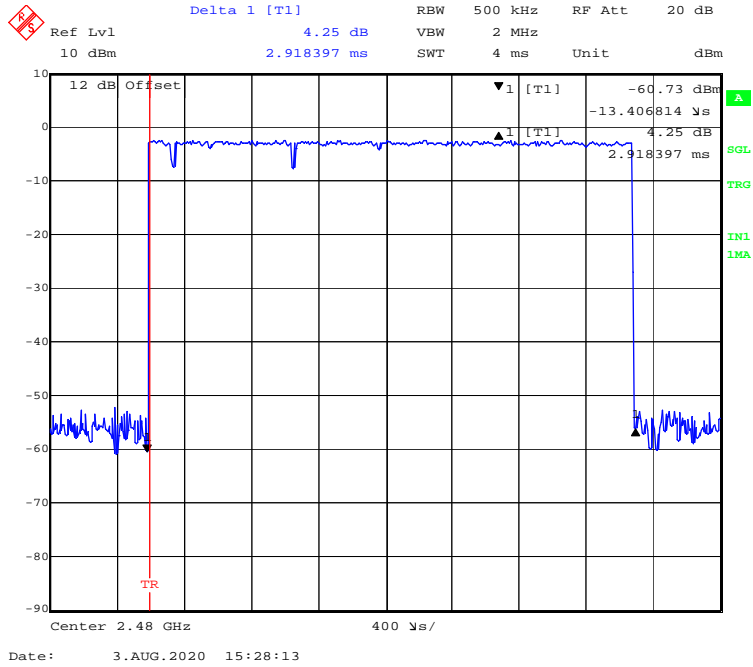

EDR (8DPSK): Pulse time, Low Channel, 3DH1

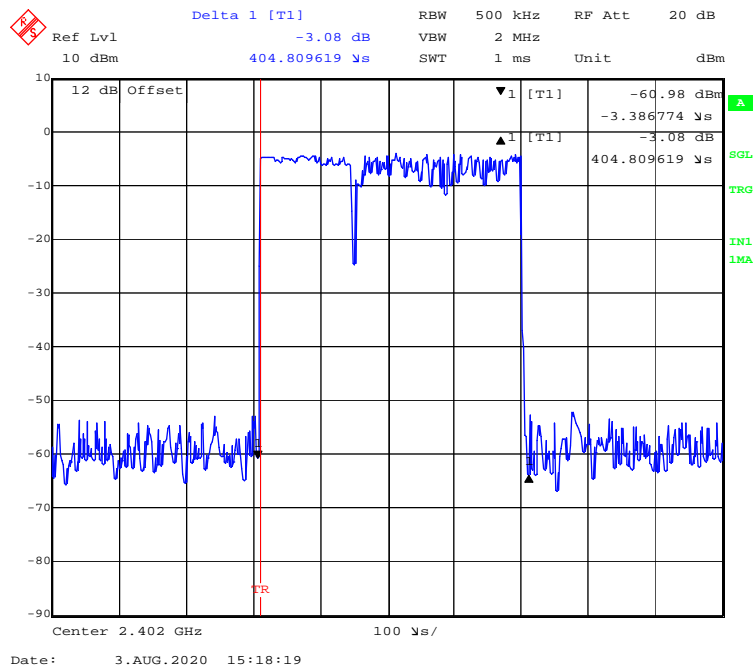

EDR (8DPSK): Pulse time, Middle Channel, 3DH1

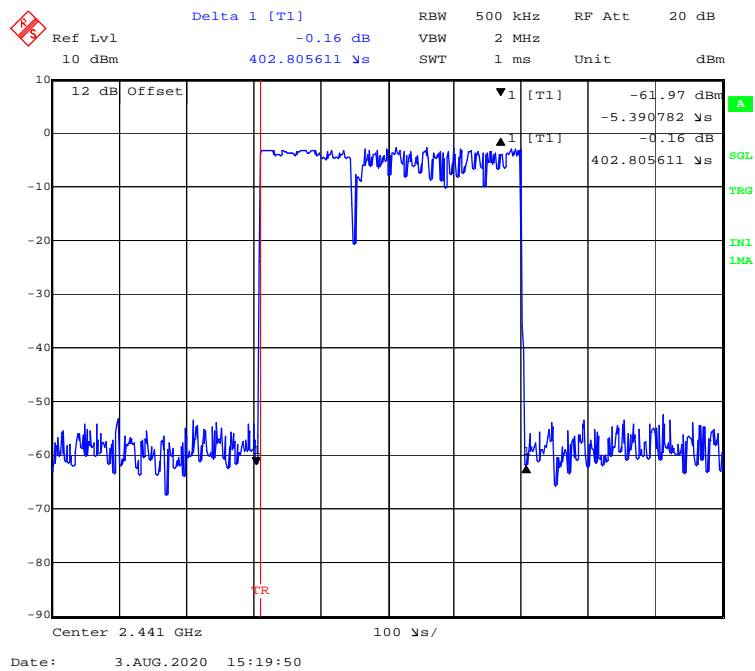

EDR (8DPSK): Pulse time, High Channel, 3DH1

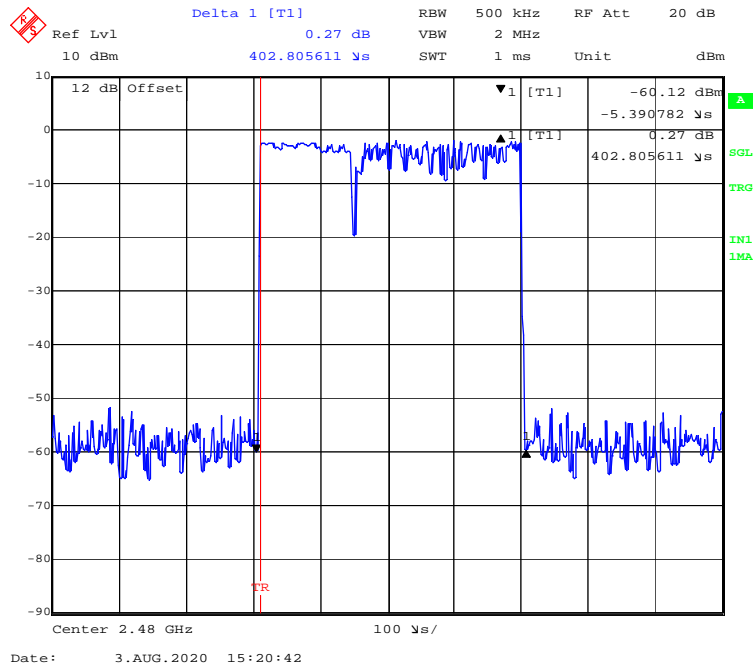

EDR (8DPSK): Pulse time, Low Channel, 3DH3

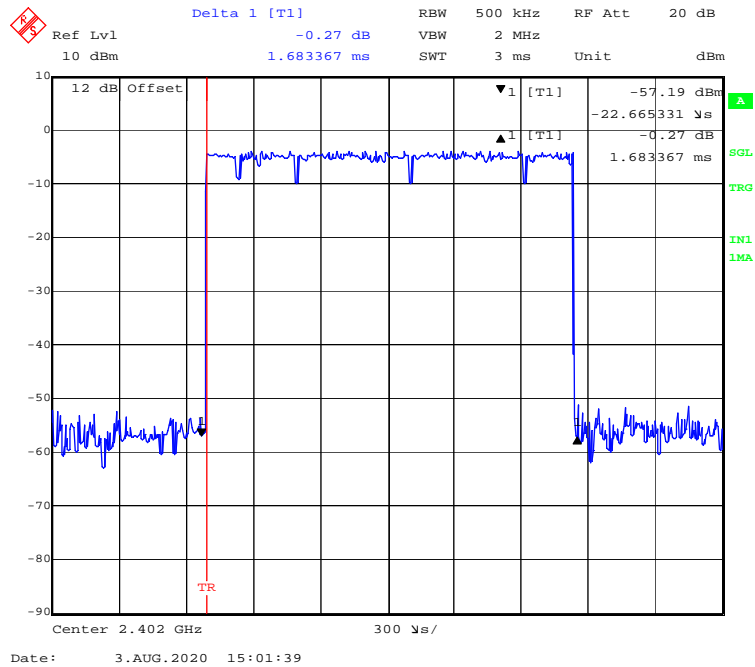

EDR (8DPSK): Pulse time, Middle Channel, 3DH3

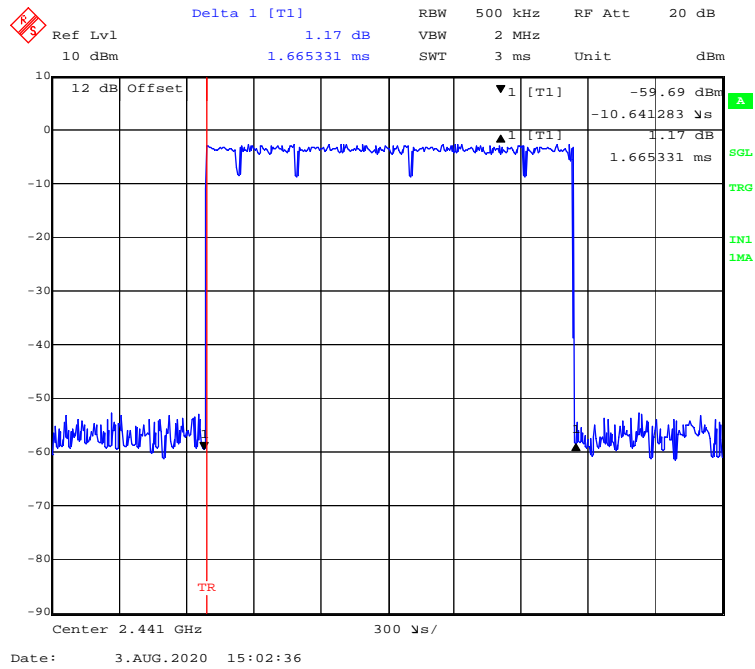

EDR (8DPSK): Pulse time, High Channel, 3DH3

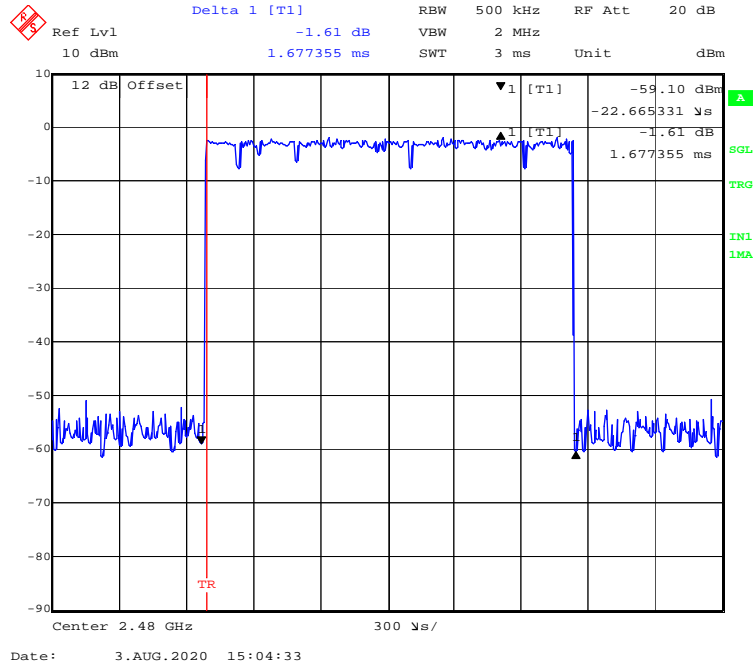

EDR (8DPSK): Pulse time, Low Channel, 3DH5

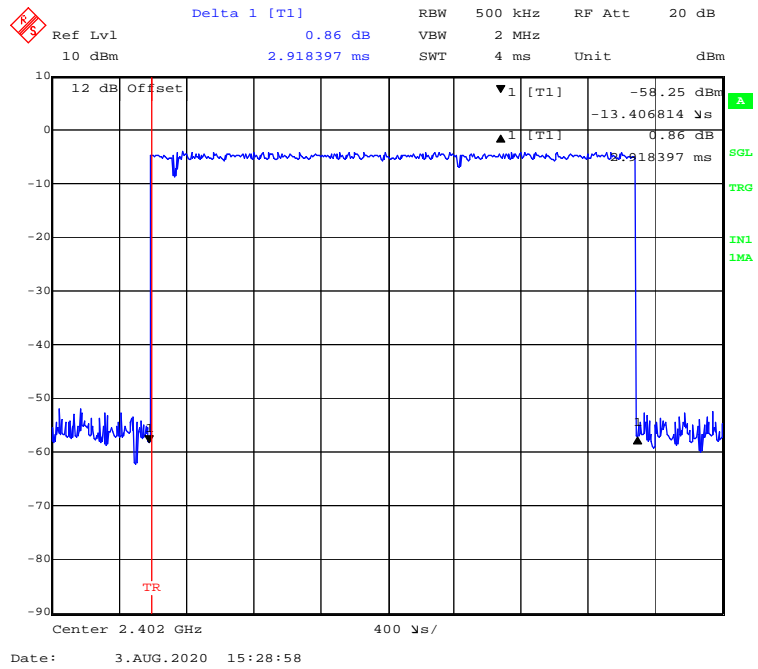

EDR (8DPSK): Pulse time, Middle Channel, 3DH5

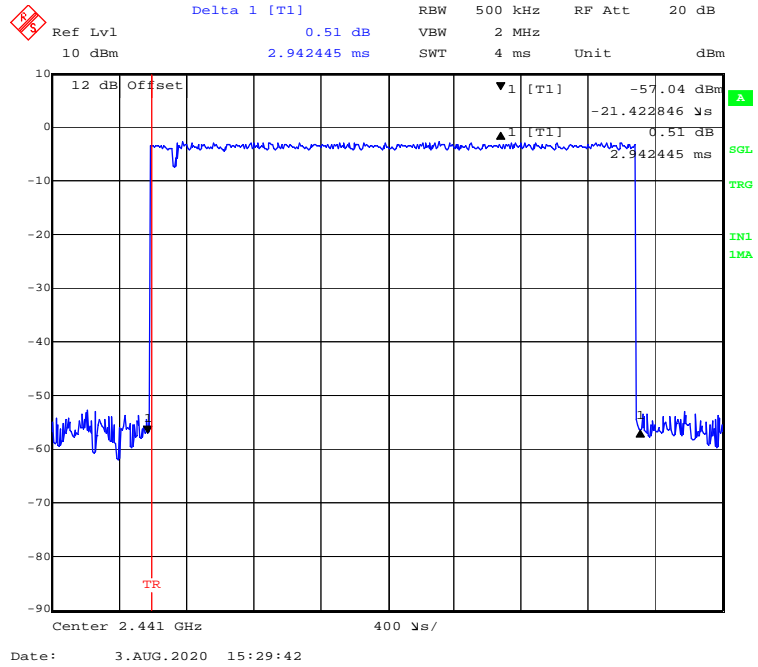

EDR (8DPSK): Pulse time, High Channel, 3DH5

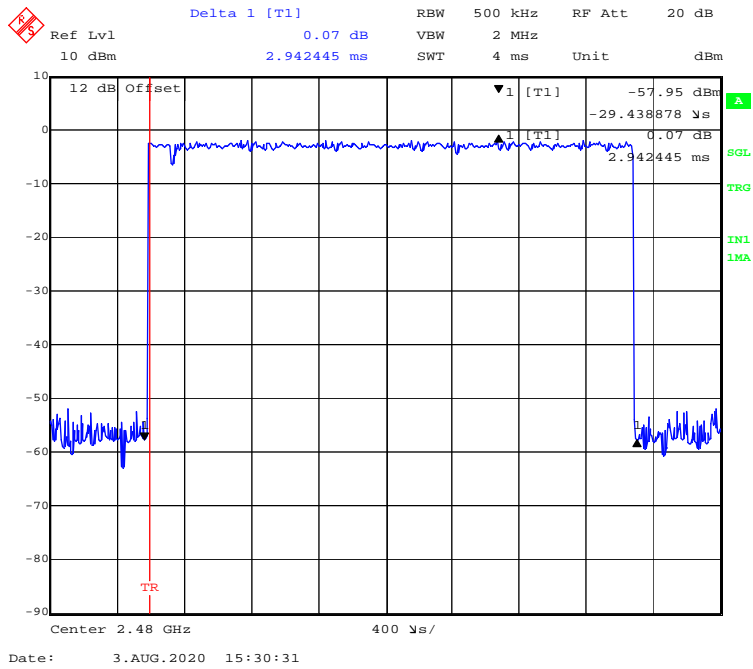

FCC §15.247(b) (1) - PEAK OUTPUT POWER MEASUREMENT

Applicable Standard

According to §15.247(b) (1), for frequency hopping systems operating in the 2400–2483.5 MHz band employing at least 75 non-overlapping hopping channels, and all frequency hopping systems in the 5725–5850 MHz band: 1 watt. And for all other frequency hopping systems in the 2400–2483.5 MHz band: 0.125 watts.

Test Procedure

- a. Use the following spectrum analyzer settings:
 - 1) Span: Approximately five times the 20 dB bandwidth, centered on a hopping channel.
 - 2) RBW > 20 dB bandwidth of the emission being measured.
 - 3) VBW \geq RBW.
 - 4) Sweep: Auto.
 - 5) Detector function: Peak.
 - 6) Trace: Max hold.
- b. Allow trace to stabilize.
- c. Use the marker-to-peak function to set the marker to the peak of the emission.
- d. The indicated level is the peak output power, after any corrections for external attenuators and cables.
- e. A plot of the test results and setup description shall be included in the test report.

Test Data

Environmental Conditions

Temperature:	26.7 °C
Relative Humidity:	61 %
ATM Pressure:	101.3 kPa

The testing was performed by Chao Gao on 2020-08-01.

EUT operation mode: Transmitting

Test Result: Compliant.

Mode	Frequency (MHz)	Output Power		Limit (mW)
		(dBm)	(mW)	
BDR (GFSK)	2402	-4.73	0.34	125
	2441	-4.61	0.35	125
	2480	-4.17	0.38	125
EDR ($\pi/4$ -DQPSK)	2402	-4.35	0.37	125
	2441	-4.35	0.37	125
	2480	-3.84	0.41	125
EDR (8DPSK)	2402	-4.05	0.39	125
	2441	-3.84	0.41	125
	2480	-3.43	0.45	125

BDR (GFSK): 2402MHz

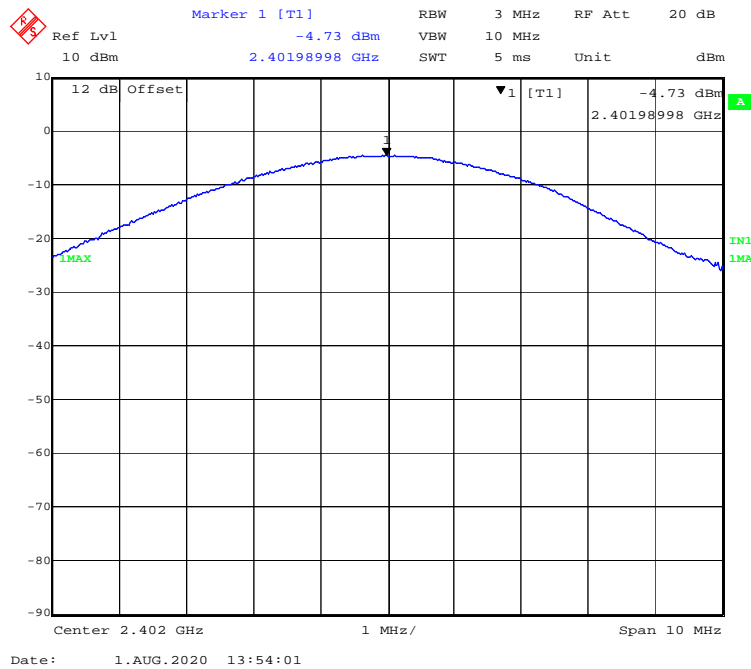

BDR (GFSK): 2441MHz

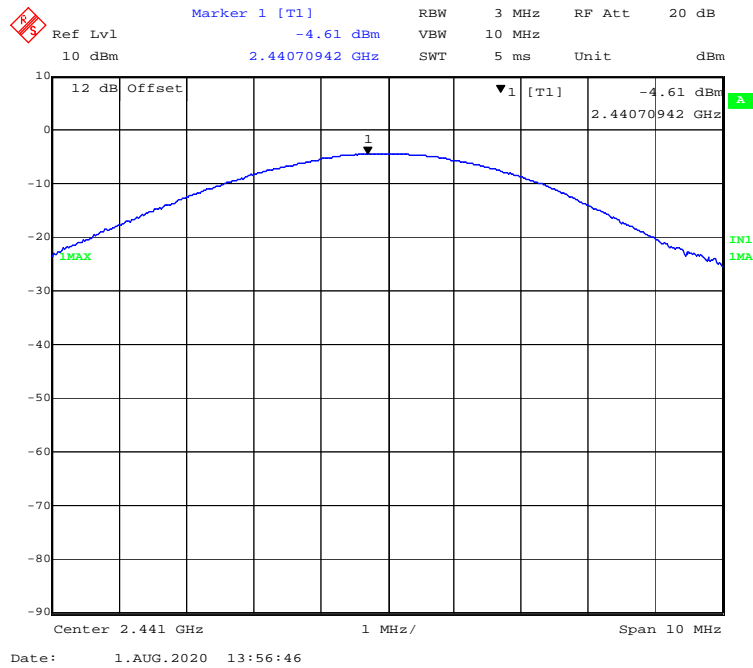

BDR (GFSK): 2480MHz

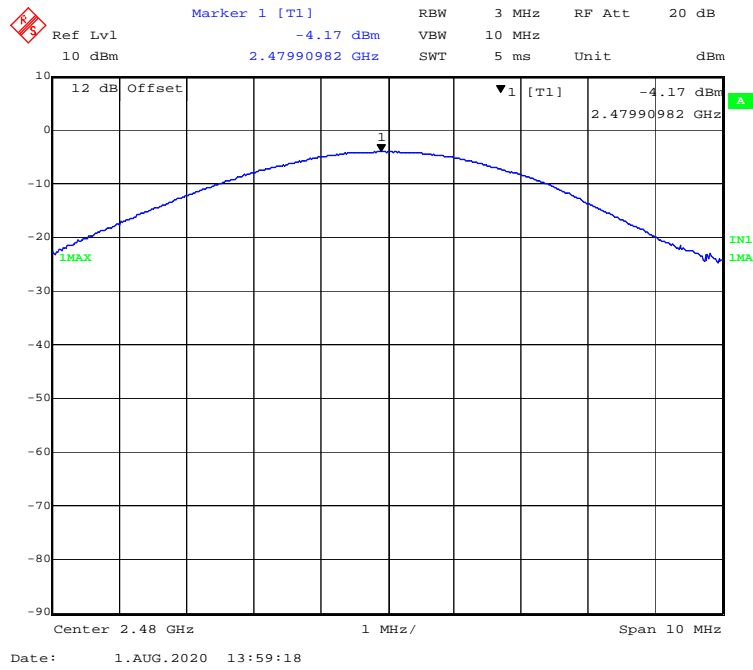

EDR($\pi/4$ -DQPSK): 2402MHz

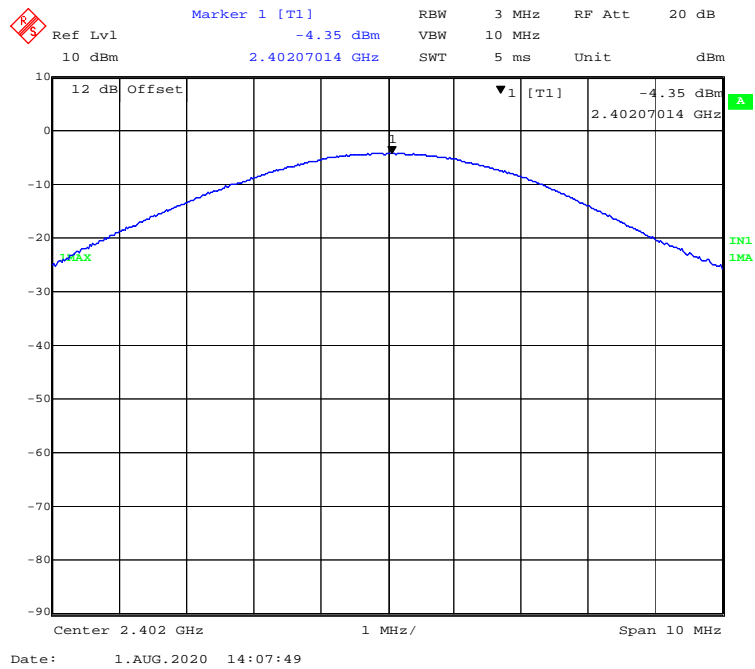

EDR($\pi/4$ -DQPSK): 2441MHz

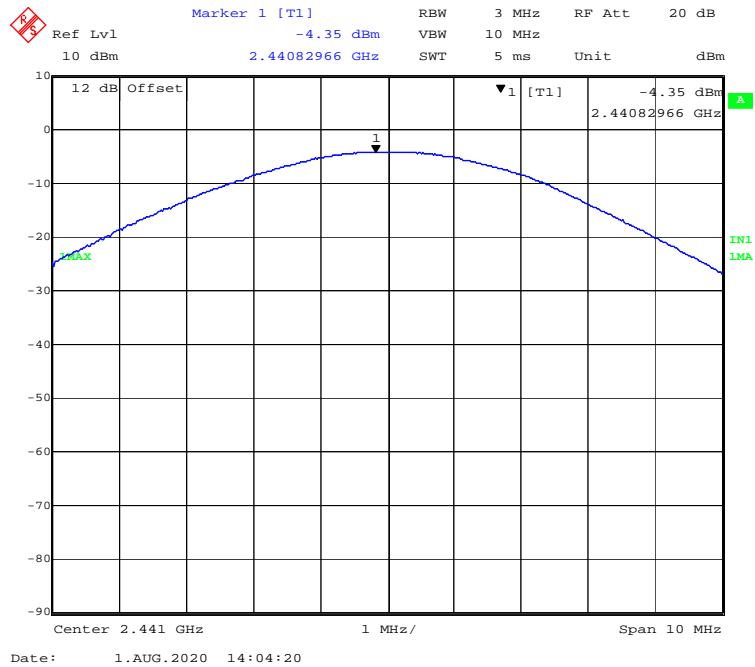

EDR($\pi/4$ -DQPSK): 2480MHz

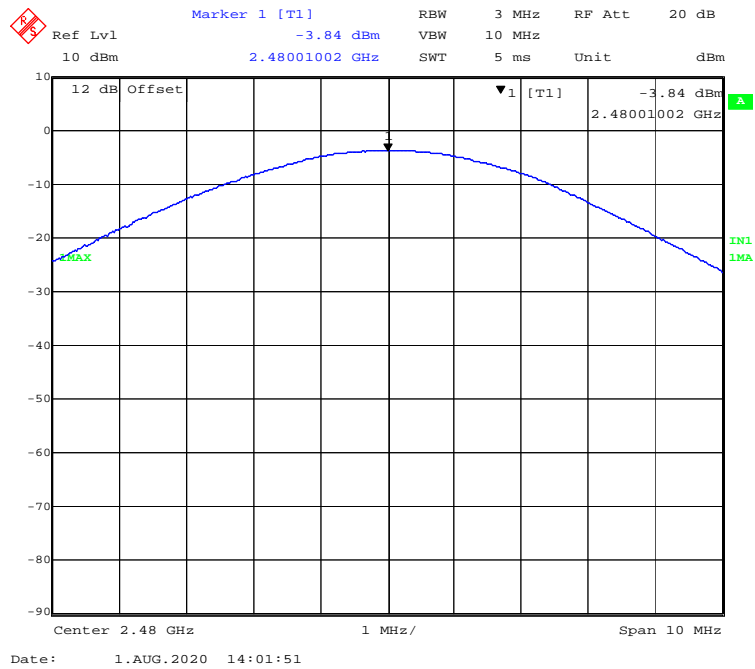

EDR(8DPSK): 2402MHz

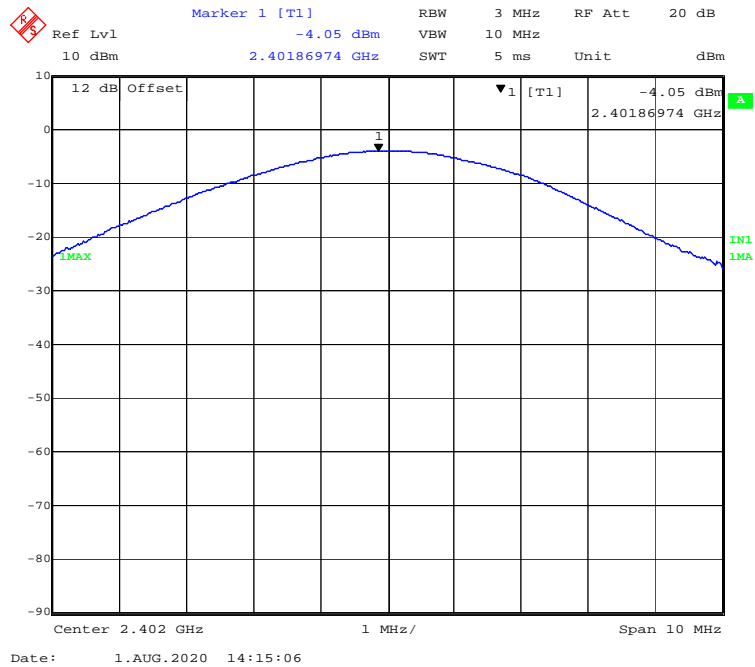

EDR(8DPSK): 2441MHz

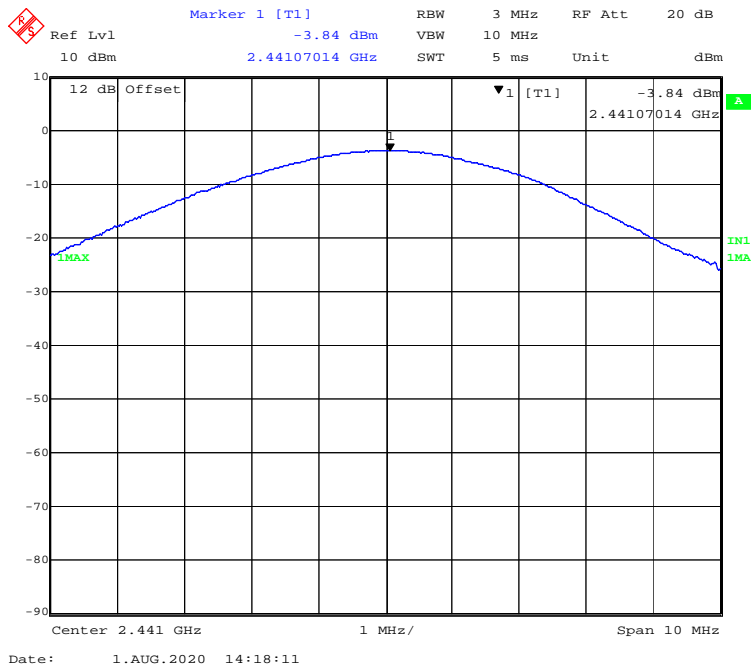

EDR(8DPSK): 2480MHz

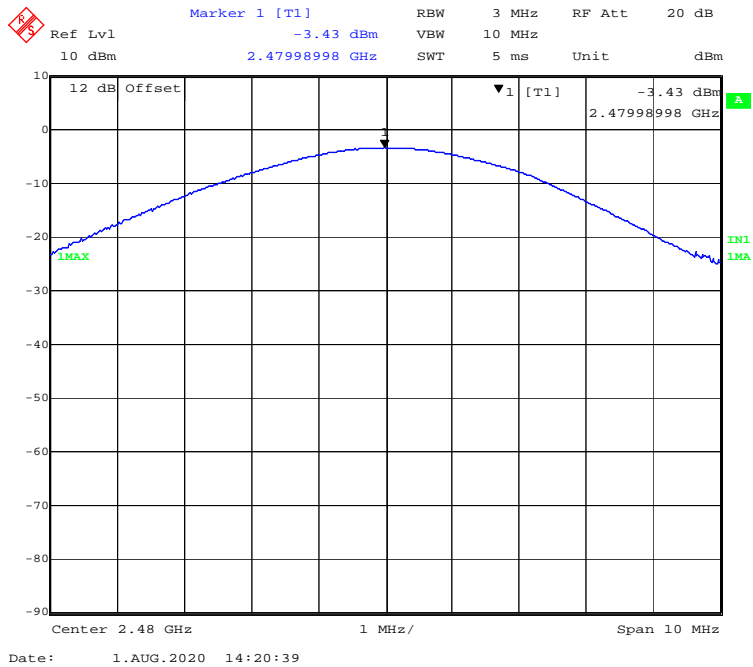

FCC §15.247(d) - BAND EDGES TESTING

Applicable Standard

In any 100 kHz bandwidth outside the frequency band in which the spread spectrum or digitally modulated intentional radiator is operating, the radio frequency power that is produced by the intentional radiator shall be at least 20 dB below that in the 100 kHz bandwidth within the band that contains the highest level of the desired power, based on either an RF conducted or a radiated measurement, provided the transmitter demonstrates Compliance with the peak conducted power limits. If the transmitter complies with the conducted power limits based on the use of RMS averaging over a time interval, as permitted under paragraph (b)(3) of this section, the attenuation required under this paragraph shall be 30 dB instead of 20 dB. Attenuation below the general limits specified in §15.209(a) is not required. In addition, radiated emissions which fall in the restricted bands, as defined in §15.205(a), must also comply with the radiated emission limits specified in §15.209(a) (see §15.205(c)).

Test Procedure

1. Check the calibration of the measuring instrument using either an internal calibrator or a known signal from an external generator.
2. Remove the antenna from the EUT and then connect to a low loss RF cable from the antenna port to a EMI test receiver, then turn on the EUT and make it operate in transmitting mode. Then set it to Low Channel and High Channel within its operating range, and make sure the instrument is operated in its linear range.
3. Set RBW of spectrum analyzer to 100 kHz with a convenient frequency span including 100 kHz bandwidth from band edge.
4. Measure the highest amplitude appearing on spectral display and set it as a reference level. Plot the graph with marking the highest point and edge frequency.
5. Repeat above procedures until all measured frequencies were complete.

Test Data

Environmental Conditions

Temperature:	24.3-26.7 °C
Relative Humidity:	51-61 %
ATM Pressure:	101.3-102.1 kPa

The testing was performed by Chao Gao from 2020-08-01 to 2020-08-03.

EUT operation mode: Transmitting & Hopping

Test Result: Compliant.

Band Edge

BDR (GFSK): Left Side - Transmitting

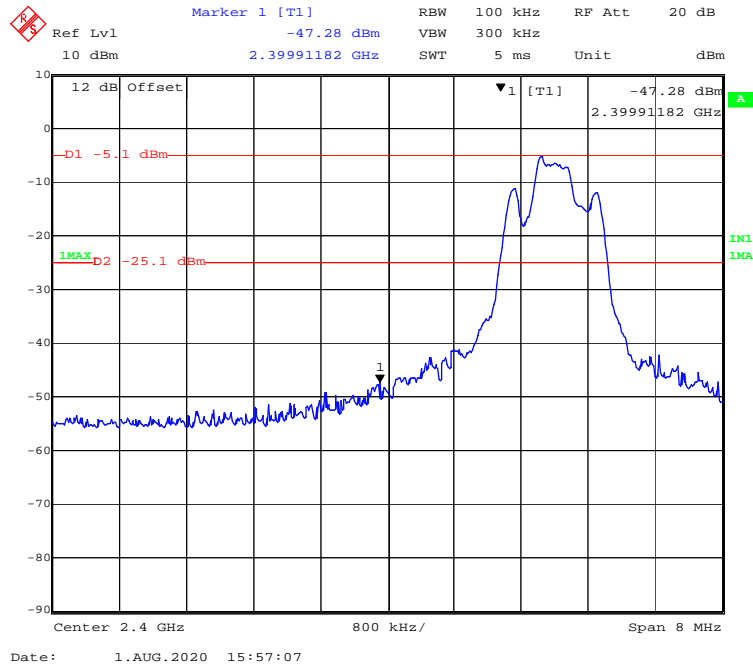

BDR (GFSK): Right Side - Transmitting

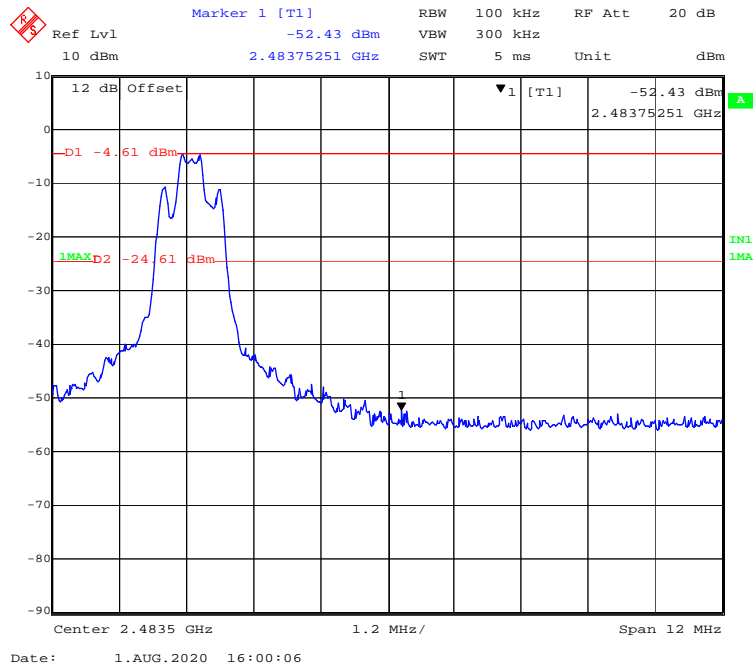

EDR ($\pi/4$ -DQPSK): Left Side - Transmitting

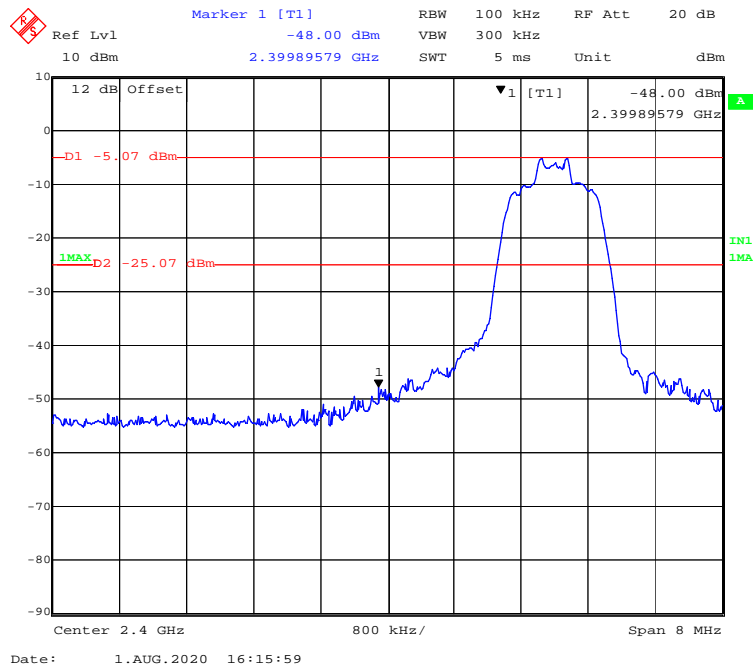

EDR ($\pi/4$ -DQPSK): Right Side - Transmitting

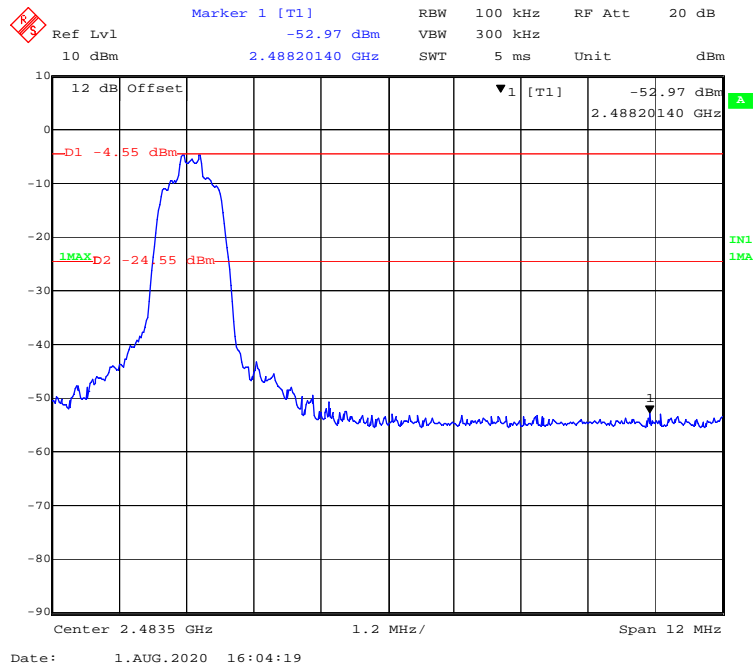

EDR (8DPSK): Left Side - Transmitting

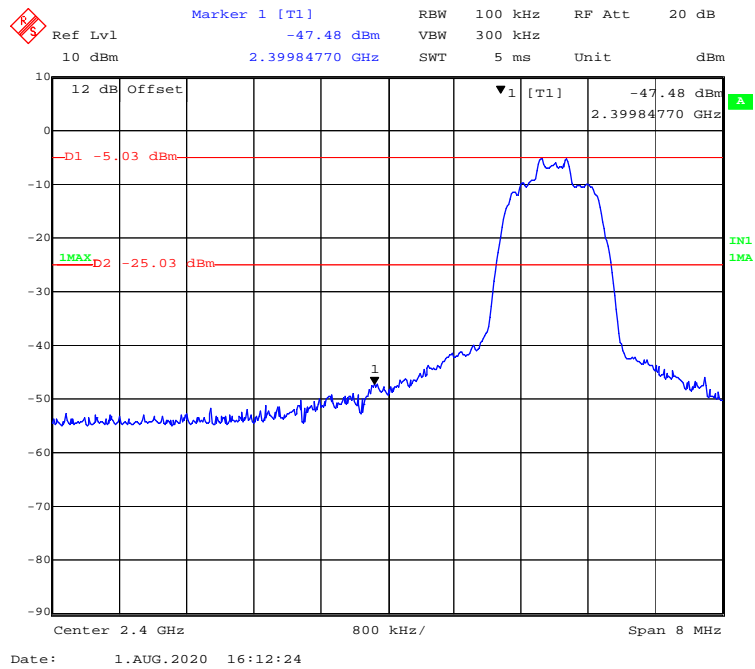

EDR (8DPSK): Right Side - Transmitting

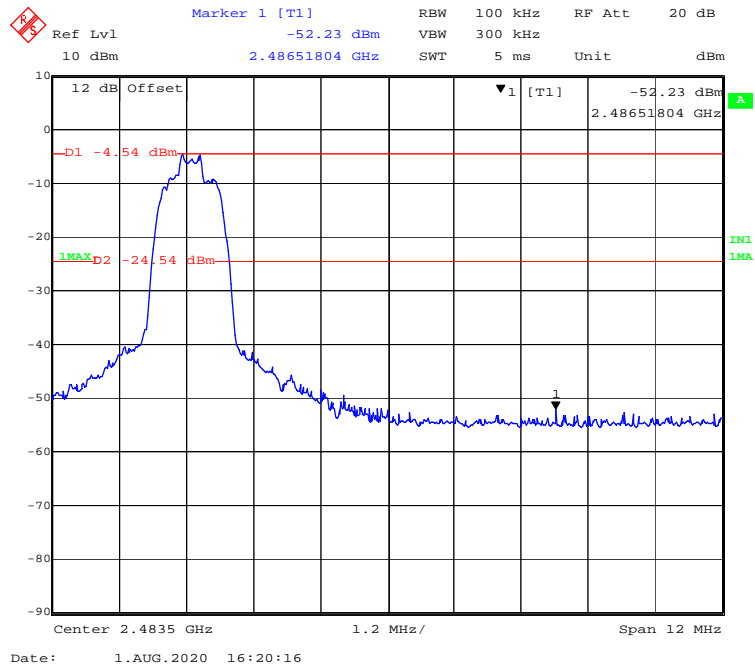

BDR (GFSK): Left Side - Hopping

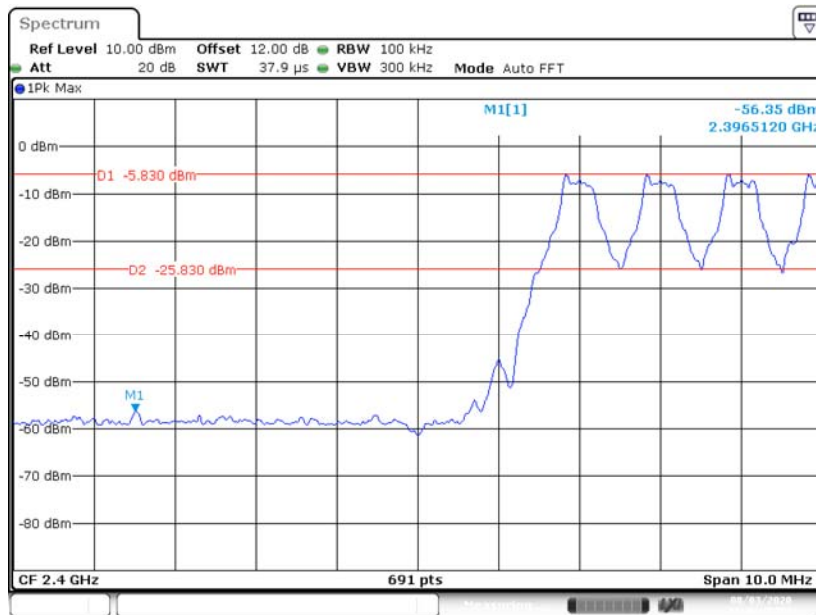

Date: 3.AUG.2020 17:49:50

BDR (GFSK): Right Side- Hopping

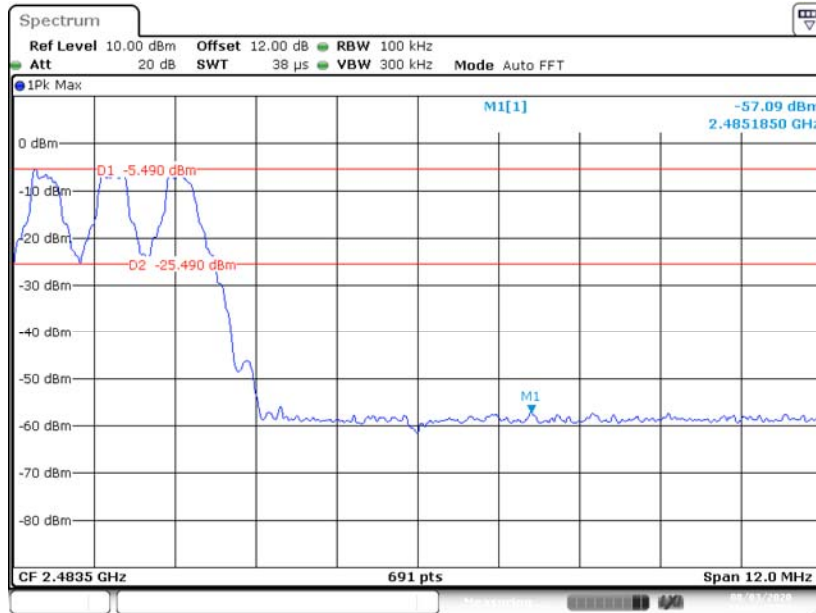

Date: 3.AUG.2020 18:39:43

EDR ($\pi/4$ -DQPSK): Left Side- Hopping

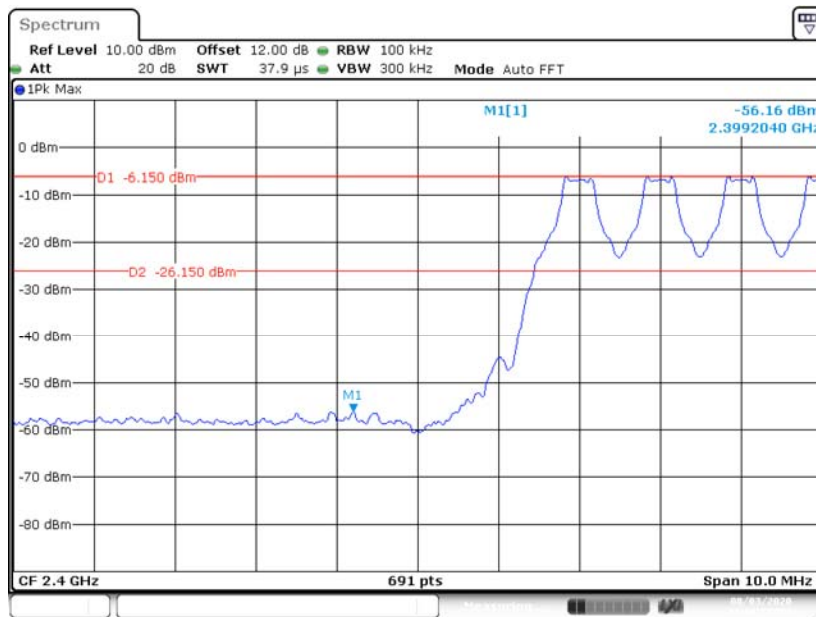

Date: 3.AUG.2020 17:56:59

EDR ($\pi/4$ -DQPSK): Right Side- Hopping

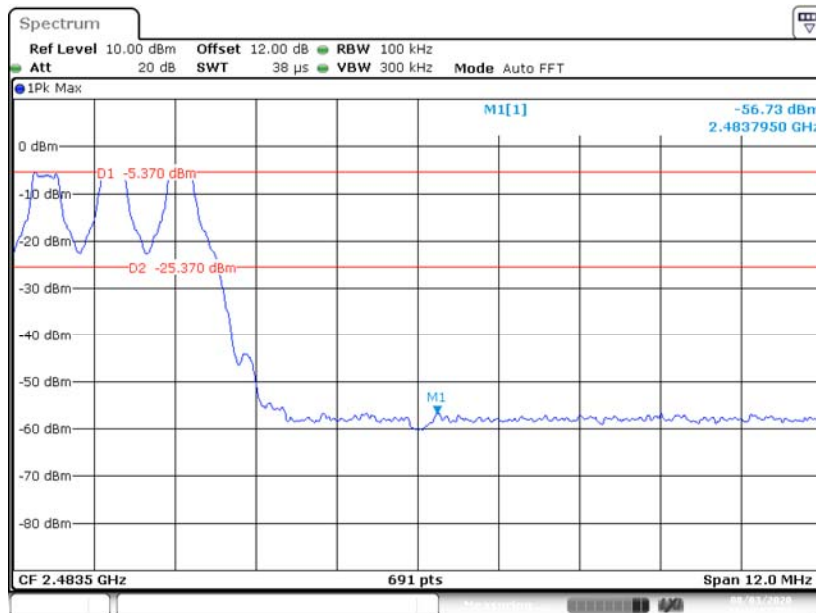

Date: 3.AUG.2020 18:19:51

EDR (8DPSK): Left Side- Hopping

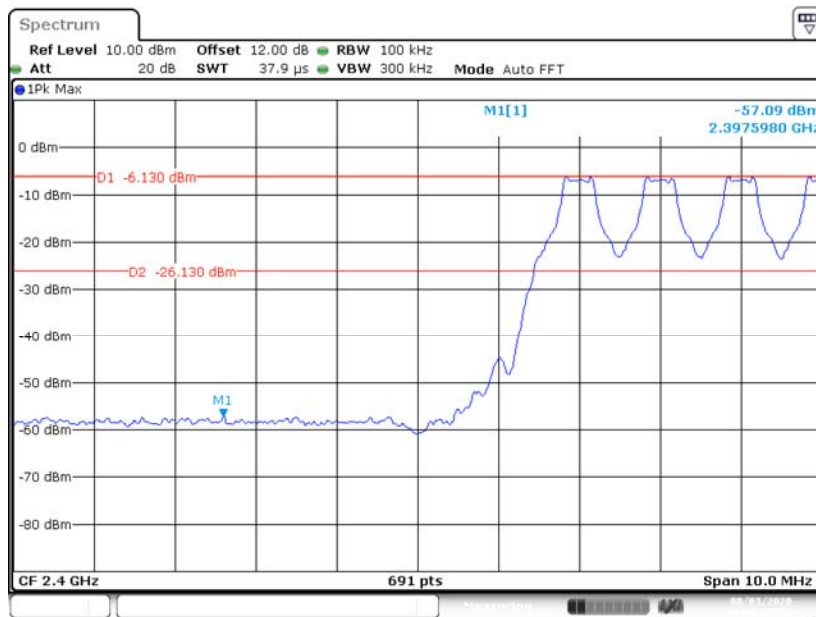

Date: 3.AUG.2020 18:02:19

EDR (8DPSK): Right Side- Hopping

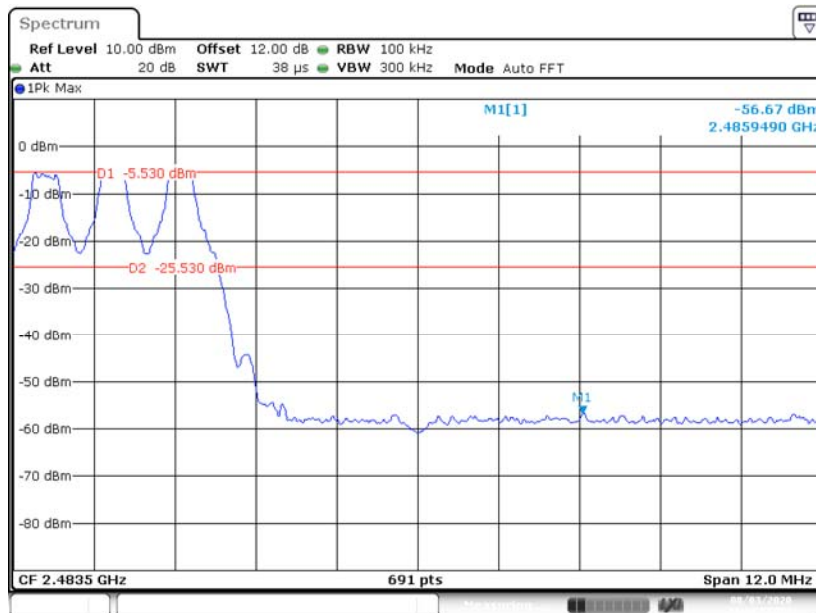

Date: 3.AUG.2020 18:07:56

Declarations

- 1: BACL is not responsible for the authenticity of any test data provided by the applicant. Data included from the applicant that may affect test results are marked with an asterisk '*'. Customer model name, addresses, names, trademarks etc. are not considered data.
- 2: Unless otherwise stated the results shown in this test report refer only to the sample(s) tested.
- 3: Otherwise required by the applicant or Product Regulations, Decision Rule in this report did not consider the uncertainty.
- 4: The extended uncertainty given in this report is obtained by combining the standard uncertainty times the coverage factor K with the 95% confidence interval.
- 5: This report cannot be reproduced except in full, without prior written approval of the Company.
- 6: This report is valid only with a valid digital signature. The digital signature may be available only under the Adobe software above version 7.0.

******* END OF REPORT *******