

OPERATION MANUAL AND WARRANTY BOOKLET

Extended SL
Track Massage Chair



Mynica

M1610
www.hellomynt.com

1 CONTENTS

ONE YEAR LIMITED WARRANTY	2
• ONE YEAR LIMITED WARRANTY	2
• NON-WARRANTY SUPPORT	2
• SERVICE AND TECHNICAL SUPPORT	2
• WARRANTY FAQs	2
IMPORTANT SAFETY INSTRUCTIONS	3
• DANGER	4
• FORBIDDEN	4
• WARNING	5
• CAUTION	7
AT A GLANCE	8
• EXTERNAL STRUCTURE	8
• INTERNAL STRUCTURE	9
• POWER BOX	10
PREPARATION BEFORE USING	11
• ENVIRONMENT CHECKING	11
• MESSAGE CHAIR COMMISSIONING	11
• FLOOR PROTECTION	13
OPERATIONS	14
• CONTROLLER MENU	14
• LCD MENU	15
• CONTROLLER INSTRUCTIONS	16
• ZERO GRAVITY INSTRUCTIONS	22
• BLUETOOTH INSTRUCTIONS	22
• GROUNDING INSTRUCTIONS	23
• ON/OFF INSTRUCTIONS	24
CARE AND MAINTENANCE	29
• STORAGE	29
• MAINTENANCE	29
TROUBLESHOOTING GUIDE	31
PRODUCT SPECIFICATION	33
FCC STATEMENT	34

2 ONE YEAR LIMITED WARRANTY

Mynta sells Extended SL Track Massage Chair Model M1610 with the intent that they are free of defects in manufacture and workmanship for a period of one year from the date of original purchase. Mynta warrants that the M1610 will be free of defects in material and workmanship under normal use and service. This warranty extends only to consumers and does not extend to retailers and resellers.

ONE YEAR LIMITED WARRANTY

M1610 has a one year labor and parts warranty. For warranty repairs, please contact Mynta customer service at Support@MyntaChair.com.

Mynta customer service will not issue Return Material Authorizations (RMAs) for products. Extended SL Track Massage Chair Model M1610 will be either repaired by the consumer or by an in-home technician. Mynta will not issue Return Material Authorizations (RMAs) for buyer's remorse.

NON-WARRANTY SUPPORT

Non-warranty repair is provided on a "per incident" basis. Mynta customer service will verify that the unit has failed and provide instructions for repairing a unit. All applicable repairs, parts, shipping, handling, local tax and a "per incident" fee will be charged for labor and non-warranty repairs.

SERVICE AND TECHNICAL SUPPORT

Mynta customer service representative will attend to most consumer inquiries, but in some cases a technical service specialist will provide advanced support.

Get help at Support@MyntaChair.com

WARRANTY FAQs

1. What isn't covered by the warranty?
 - Purchases from unauthorized resellers

Improperly operated devices
Lost or stolen products
Purchases made over limited warranty time
Non quality-related issues
Free products
Damage due to misuse, improper treatment and unauthorized modification and repair are not covered by this warranty.
Warranty does not cover accessories and attachments which do not belong to the massage unit.

2. When does the warranty begin?

Warranty begins from the day you place your order.

3. How do I claim the warranty?

Send an email to Support@MyntaChair.com with your unit serial number and Proof of Purchase (original receipt) for all repairs or services.

If you made your purchase through an authorized Mynta Reseller, you may contact the Reseller for a copy of your receipt.

If the product was a gift, you may ask the giver to provide you with a copy of the sales receipt or claim the warranty on your behalf.

3 IMPORTANT SAFETY INSTRUCTIONS

The following safety instructions is of great help to your correctly use of this massage chair.

- **READ ALL THE INSTRUCTIONS** and cautionary markings in this manual before using the massage chair. Follow the instructions and keep the manual for future reference.
- **USE ONLY AS INSTRUCTED.** Use this device only as described in this manual. Any misuse excludes any liability for damage, incorrect use may cause electric shocks, fires, burns, or other unexpected hazards. To clearly indicate the degrees of danger and damage, the classes of accidents caused by incorrect use are classified into **DANGER**, **FORBIDDEN**, **WARNING** and **CAUTION**. Instructions marked as followings should be strictly followed.

DANGER

To reduce the risk of electric shock:

- A massage chair should never be left unattended when plugged in. Always switch off power and remove the plug from the mains socket immediately after using, before cleaning, putting on or taking off parts.
- To avoid fire disaster or damage massage chair, please do not use the power supply that is beyond the specified electric voltage.
- Close supervision is necessary when this massage chair is used by, on, or near children, invalids, or disabled persons. Keep children and pets away from reclining backrest and extended footrest.

FORBIDDEN

- Do not allow children to play near the chair especially during operation.
- Do not leave mobility impaired or speech impaired people alone in chair.
- Do not place or stock this machine near damp places such as swimming pools or bathrooms.
- Do not press by force on the massage rollers.
- Do not stand on or in the chair, never store heavy items on the chair. Use only while seated.
- Do not use in the environment which is dusty, greasy or lacking oxygen.
- Do not place near steam oven, open fire, or heat.
- Do not massage with bare skin, wear suitable clothing.
- Do not place directly in the sun.
- Do not use electric blanket while using the massage chair.
- Do not use outdoors.
- Do not use while smoking.
- Do not use immediately after meals or after drinking alcohol.
- Do not sit on backrest, legrest, or armrest to avoid accidental injury or machine fault.

- Do not use the massage chair when your body is wet or moist as it can result in electrical shock.
- Do not use when using head ornamentation as it can result in injury.
- Do not stumble over electrical wires or connections.

WARNING

To reduce the risk of burns, fire, electric shock, or injury:

- Do not use attachments not recommended by the manufacturer.
- Operate the massage chair on flat ground only.
- Any other use not recommended by the manufacturer may cause electrical shock or injury.
- Connect this appliance to a properly grounded outlet only. See Grounding Instructions.
- To disconnect, turn all controls to the off position, then remove plug from outlet.
- Only people less than 120kgs are acceptable.
- Empty pockets and remove all your arm jewellery and watch before using this chair.
- Do not operate under a blanket or pillow. Excessive heating can occur and cause fire, electric shock or injury.
- Do not operate the massage chair with the air openings blocked. Keep the air openings free of lint, hair, and the like.
- Do not insert, unplug the power plug or operate the controller with damp hands, and do not put heavy objects on controller.
- Do not drop or insert any object into any opening.
- Do not operate where aerosol (spray) products are being used.
- Do not remove the back cushion and do not play with roller mechanism.
- Do not remove the bottom seat and do not play with actuators.
- Do not touch or re-wire the wires connected to the master-box.
- Do not attempt to repair or adjust any electrical or mechanical functions on this unit. Doing so will void the warranty.

- Do not put your hands or head under the chair.
- When using the massage chair, ascertain that the footrest is in the lowest position.
- Do not use over insensitive skin areas or in the presence of poor circulation. The unattended use of heat by children or incapacitated persons may be dangerous.
- Do not use other therapeutic equipment together with this massage chair.
- Do not continuously use the massage chair over 30 minutes, and it is limited to massage a particular part of body in 5 minutes.
- Do not operate any equipment with damaged parts.
- Keep the cord away from heated surfaces.
- Keep the cord out of heavy traffic areas.
- Do not carry this massage chair by supply cord or use cord as a handle.
- Never operate this massage chair if it has a damaged cord or plug, if it is not working properly, if it has been dropped or damaged, contact Mynta Customer Support Team.
- When removing power plug, please hold the insulation plug, do not pull power cord.
- Do not fall into sleep on massage chair, when the massage chair is working.
- This massage chair is designed and intended for non commercial household use only. Do not use the massage chair for medical treatment.

When adjusting the legrest or backrest, please do not exert excessive force on it; in addition, keep children and pets well clear. Before using, please uncover the back cushion to check whether backrest or fabric is damaged: if damaged, stop using this massage chair immediately, and contact Mynta Customer Support Team. During use, if you feel uncomfortable, please stop use immediately and consult your doctor.

The massage chair is equipped with heating function, so people who are insensitive to heat must use it carefully to avoid causing serious burns.

CAUTION

The massage chair is designed as a non-clinical device, to soothe tired and aching muscles. It is not intended to be a substitute for medical attention.

Each massage - even a hand massage - must be refrained from during pregnancy or if one or more of the following complaints are present in the massage area:

Blood stasis

Tumor site

Heart disease, with a pacemaker or defibrillator

Sensitive areas: head, face, cervical vertebrae, spine vertebral body.

Positions close to the bone with less muscle coverage: the humerus, the back of the foot, the back of the hand.

Not recommended for the following people:

- Patients with serious hyperostosis
- Swollen lump and patient thrombosis
- Patients with serious heart conditions
- Pregnant Women
- People that consume large amounts of alcohol
- People with diabetes
- People suffering from high fever
- Patients with malignant tumors or malignant abscesses
- People with distorted joints
- People with serious skin conditions
- People with spinal injuries
- All people should consult a physician and exercise care when operating this system
- Minors under 16 years or people unable to control his/her behavior, i.e. mental patients, people with paralysis, etc. should not be allowed to operate the massage chair.

It is recommended to consult a doctor before having a massage for the treatment of ailments and illnesses.

If you are dependent on electrical aids e.g. pacemakers, MUST consult your doctor for medical advice before taking a massage. If your ailments and symptoms persist or worsen after use, contact your doctor immediately.
DO NOT use after taking painkillers, sedatives or alcohol. Consult your doctor if you are taking medication.

4 AT A GLANCE

EXTERNAL STRUCTURE

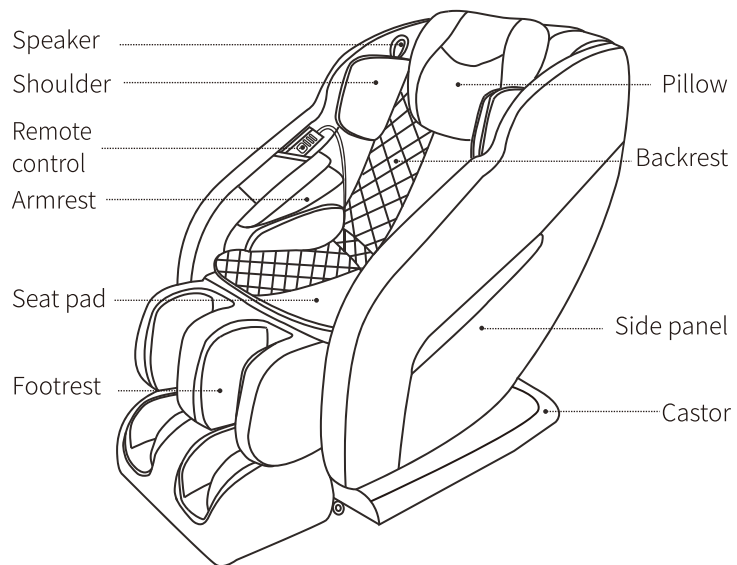

INTERNAL STRUCTURE

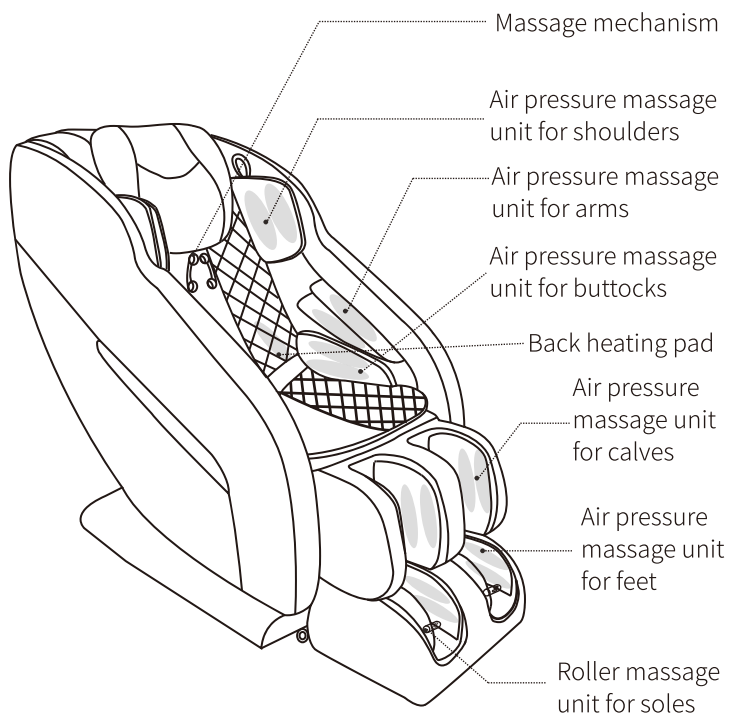

POWER BOX

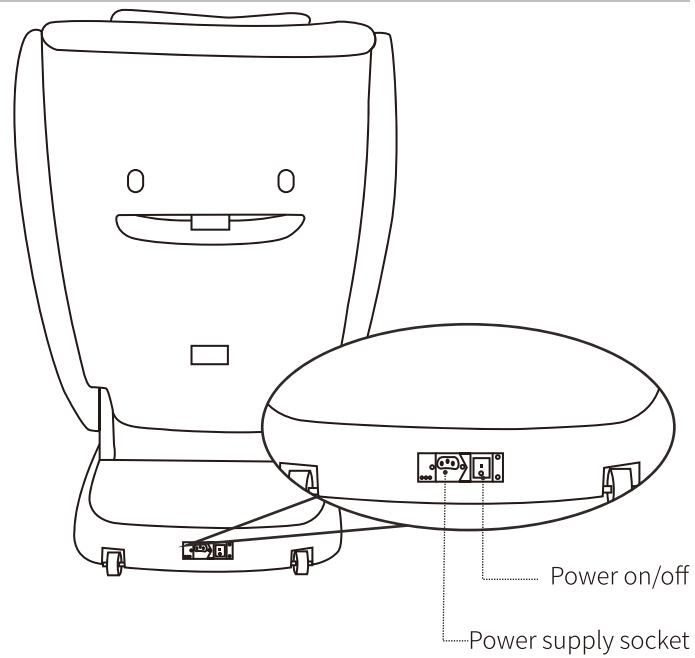

CAUTION

Do not allow children to play on the chair in case accident happens.
Please power off the chair and unplug the chair from the power supply socket after the massage.
Do not use the chair under thunders in rainy days.
Please power off the chair and unplug the chair from the power supply socket when the chair is not in use, so that children won't accidental get the chair started.
Please store the chair properly if it is not in use.

5 PREPARATION BEFORE USING

ENVIRONMENT CHECKING



Don't use the chair in wet places like near swimming pool, bath room to avoid leakage or electric shock.



Don't use under sunlight or near stove or other heating device to avoid fire or damage to leather material.

Please use chair in flat place to avoid chair falling or noise or other unexpected trouble.

MESSAGE CHAIR COMMISSIONING

Before commissioning, please make sure there is enough space around the chair.

Back: minimum 15cm from the wall or any other blocks
Front: minimum 50cm from any blocks

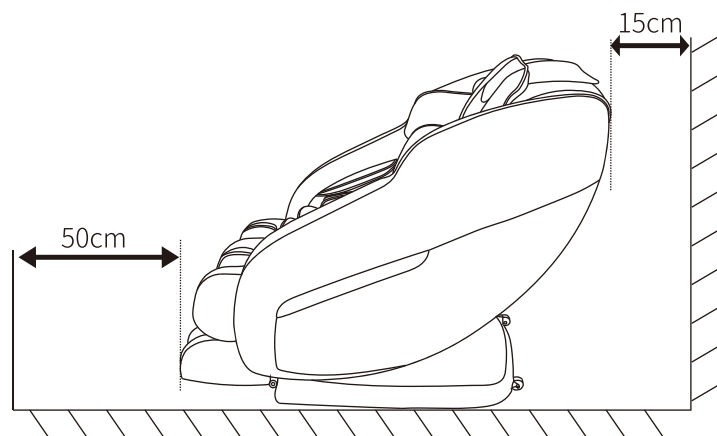

Press down the backrest as showed in the figure, recline the chair to approximate 45° to easily move the chair by the rollers around the house with a slight pull or push. There are moving rollers at the bottom of the chair. Raise the back to the highest point.

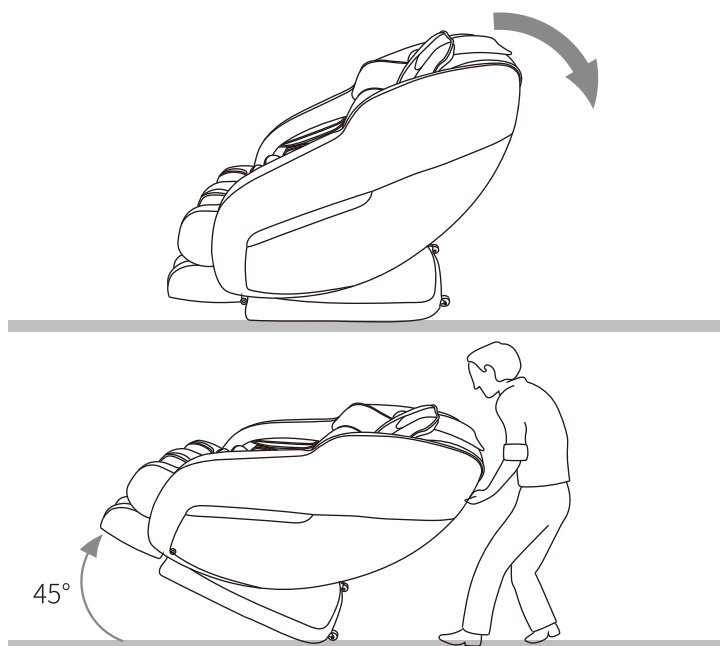

Don't move it when there is people in it.
Don't use the armrest while moving the chair, only hold the moving holder in the back and front.
Do not put fingers or any other objects into the gap between the seat and legrest.



CAUTION

When adjusting up and down angles of the backrest and legrest, make sure there is no obstacle around the massage chair.

During using, please make sure the power cord is not enlaced or clamped but laid orderly.

Before sitting in the chair, make sure the chair is in original position, if any part is not in initial position, please power on/off again to make the whole chair go back to original position.

If the legrest rises up, please do not seat on the chair. Do not make the legrest suffer from heavy loading suddenly, or it may damage the legrest mechanism.

FLOOR PROTECTION

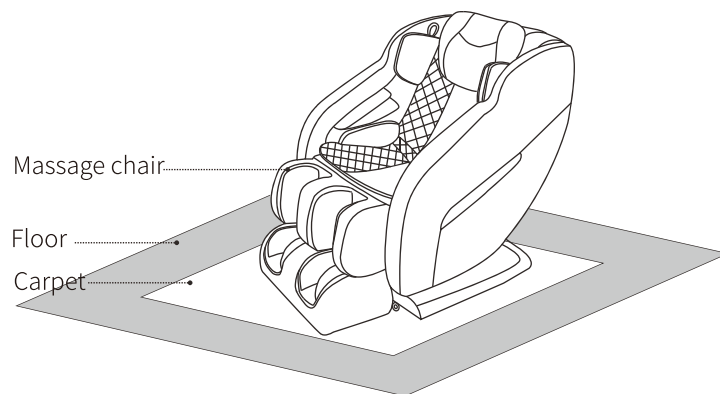

6 OPERATIONS

CONTROLLER MENU

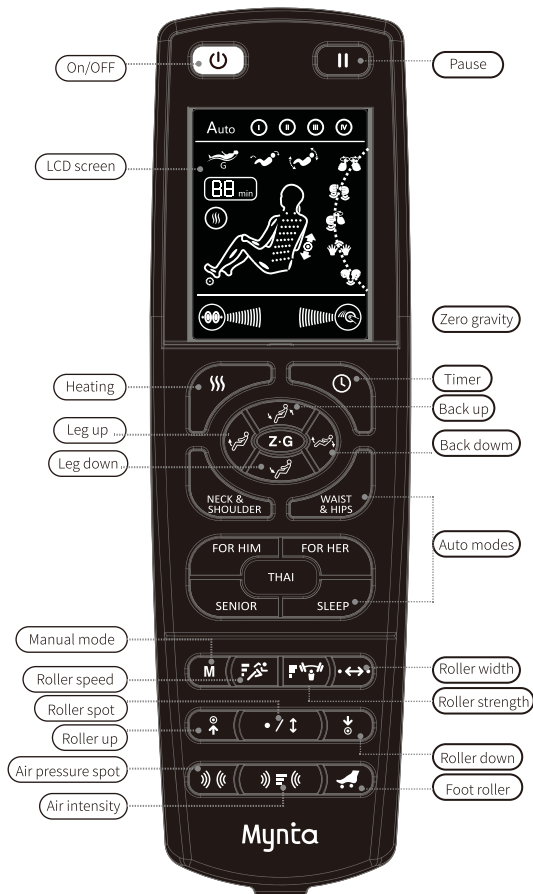

On/OFF



Pause

LCD screen

Zero gravity

Heating



Timer

Leg up



Back up

Leg down



Back down

NECK & SHOULDER

WAIST & HIPS

Auto modes

FOR HIM

FOR HER

THAI

SENIOR

SLEEP

Manual mode

M

Roller width

Roller speed



Roller strength

Roller spot



Roller up



Roller down

Air pressure spot



Foot roller

Air intensity





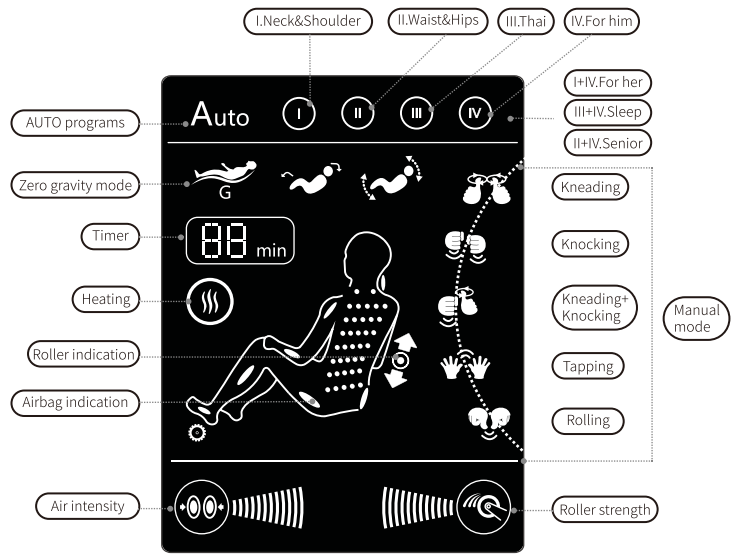

LCD MENU



CONTROLLER INSTRUCTIONS



1. BASICS

	ON/OFF	Start Stop Control	Press once to light up the LCD screen. Press any massage function button to start massage. This will initiate the timer with 15 mins defaulted. Press again to stop all massage functions, massage chair will return to its original position.
	PAUSE	Pause Control	Press once to halt current massage and countdown timer. Press again to resume previous massage functions, as well as countdown timer.
	LUMBAR HEATING	Lumbar Heat Function Start Stop Control	Press once to activate lumbar heat function, press again to stop heating. Note: Heat can be enabled even during Auto Program modes.
	TIMER	Time Interval Control	When a massage function is activated, the timer is preset at 15 minutes. Every following single press on this button will change the timer interval in the sequence of 20>25>30>5>10>15>20 minutes.



2. ZERO GRAVITY







	ZERO GRAVITY	Zero Gravity Function Control	Press this button to activate the zero gravity position. Every following single press on this button will change the Zero Gravity modes in the sequence of Zero Gravity mode2 >Zero Gravity mode 3>Zero Gravity OFF>Zero Gravity mode1>Zero Gravity mode2.
---	-----------------	-------------------------------------	--

2. ZERO GRAVITY

	<p>LEGREST RECLINE AND RESTORE</p>	<p>Angle Adjustment Button for Legrest</p>	<p>Feet up Press this button, the legrest will be moved up to the top position, release this button, legrest stops moving. Feet down Press this button, the legrest will move down to the lowest position, release this button, legrest stops moving.</p>
	<p>CHAIR RECLINE AND RESTORE</p>	<p>Angle Adjustment Button for backrest</p>	<p>Back up Press this button, the backrest will be moved up to the original position, release this button, backrest stops moving. Back down Press this button, the backrest will be moved down to the lowest position, release this button, backrest stops moving.</p>

3. AUTO MODES





	<p>NECK & SHOULDER</p>	<p>Neck and Shoulders</p>	<p>A full body massage, mainly focus on your neck and shoulders with a slow massage that incorporates soothing heat to relieve neck and back pain symptom. The curve design of the chair backrest makes the massage rollers completely fit the shoulder and the neck, which can effectively relieve fatigue and stiffness.</p>
	<p>WAIST & HIPS</p>	<p>Lower Back, Waist and Hips</p>	<p>A full body massage, mainly focus on your lower back, waist and hips with a deep massage that includes air compression to relieve the symptoms of lumbar spine pain. This is an exclusive massage</p>



	WAIST & HIPS	Lower Back, Waist and Hips	program for the workplace walks, according to the features of long time desk work and business trip, it can ease muscles and recuperate body.
	THAI	Thai Stretch	This massage will stretch your calf muscles and hamstrings with a combination of gentle tapping, kneading, rolling, and air compression. This massage is inspired from Thai Massage, the strong kneading and stretch of the body can effectively stretch legs, it's the best choice to relax tired muscles and increase physical vigor.
	FOR HIM	Deep Massage	A full body deep massage includes Shiatsu, Knocking and Tapping to ease and relax muscles after intense exercise, especially promote the body circulation system to improve the muscle recovery after exercise.
	FOR HER	Gental Massage	A full body gentle massage includes Kneading and Heating, specially designed for female.
	SENIOR	Recommended for Senior Citizens	A full body most gentle massage includes Kneading, specially designed for the elderly.
	SLEEP	Rest & Sleep	A program designed to provide a mild massage that is great for deep relaxation. This is the caring program to help improve the quality of lunch break and sleep. The mild massage kneads body parts from heavy strength

	SLEEP	Rest & Sleep	to light one, from light to no strength to help soothe tired body gradually. Product features front and rear swing function that takes you into the fantasy space swinging state and a thorough relaxation, best used before going to sleep.
---	-------	--------------	---

4. MANUAL MODES

4.1 MANUAL MESSAGE START BUTTON		MANUAL MESSAGE	Start Choose Manual Customi- zation modes	<p>KNEADING, KNOCKING, KNEADING-KNOCKING, TAPPING, SHIATSU</p> <p>Press this button to activate the rhythmic kneading manual massage function for a full back massage at medium strength. Every time this button is pressed, the manual message function will change in the sequence of KNEADING>KNOCKING>KNEADING-KNOCKING>TAPPING>SHIATSU</p> <p>Note: The above manual setting modes could not be combined with other modes. The default setting is spot-specific message with medium width. Speed and width is adjustable by pressing relative button.</p>
---	---	-------------------	--	--

4.2 BACK ROLLER		ROLLER WIDTH	Roller Width Adjustment	Every single press on this button will change the message width interval in the sequence of NARROW>MEDIUM>WIDE. Only effective under manual massage mode.
		SPOT PARTIAL	The Spot or Partial Back Massage	Press this button once to activate localized Spot Massage while the original massage mode continues to run at the latest position. Every single press on this button will change the message function in the sequence of SPOT > PARTIAL > STOP. Note: Partial Massage will use the latest Spot position as the center, and will travel approximately 8cm up or down. Only effective under manual massage mode.
		ROLLER UP/DOWN	Roller Location Adjustment	When the spot and partial massage functions are activated, this button can be used to move the massage rollers. Hold this button to move the massage rollers upward/downward respectively. Release the button when you've reached your desired position. Only effective under manual massage mode.
		ROLLER SPEED	Roller Speed Adjustment	Every single press on this button will change the message speed interval in the sequence of SLOW>MEDIUM>FAST. Only effective under manual massage mode.
		ROLLER STRENGTH	Roller Strength Adjustment	Every single press on this button will change the message strength interval in the sequence of LOW>MEDIUM>HIGH. Only effective under manual massage mode.

4.3 AIR PRES- SURE		AIR PRESSURE SPOT	Air Pressure Massage Location Adjustment	Press this button to activate body air pressure massage from shoulder to soles. Every single press on this button will change the air massage function in the sequence of SHOULDER>ARM>CALF-&FOOT>STOP.
		AIR INTENSITY	Air Pressure Intensity Adjustment	When the air massage function is engaged, every single press on this button will change the air intensity in the sequence of LOW>MEDI-UM>HIGH.
4.4 FOOT ROLLER		FOOT ROLLING	Foot Rolling Function Start/Stop Control Button	Press this button once to activate rhythmic rolling massage at soles, press this button again to stop rolling massage at soles. Double row rollers massage on foot conduct an all-around shiatsu massage onto the sole. Note: During Auto Program mode, pressing this button can also disable/en-able the foot rolling function.

ZERO GRAVITY INSTRUCTIONS

Zero-gravity is based on the NASA Space capsule relaxation theory. Using back, seat, and legrest, the chair can make the angle 120 - 134 degrees between body and legrest. This puts the heart and knee at the same level, reducing the blood circulation pressure. Not only that, but all the gravitational forces can be dispersed to the massage chair, reducing heart and spine pressure. This makes the zero gravity position the most relaxing position possible.

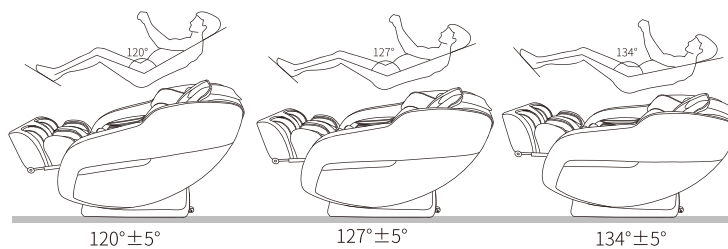

BLUETOOTH INSTRUCTIONS

Play Mobile Music: Bluetooth speaker: Turn on Bluetooth of mobile, then select Bluetooth device of massage chair (M1610). once pair, it can act as speaker when mobile phone is playing music. (Remarks: No Password)

ON/OFF INSTRUCTIONS

Make sure the chair is in original position before using.
Before sitting down, make sure there is nothings pinched between armrest, legrest, backrest and seat of the chair.
Make sure there are no people, pets or anything else within range of the backrest to avoid unexpected injury or property loss.
When adjusting the backrest, be careful of the gap between the backrest and armrest.
Empty pockets and remove all your arm jewellery and watch before using this chair.
When the legrest is moving, please do not stand up or leave from the seat, do not stop the legrest from moving to avoid damage to the chair.

ON

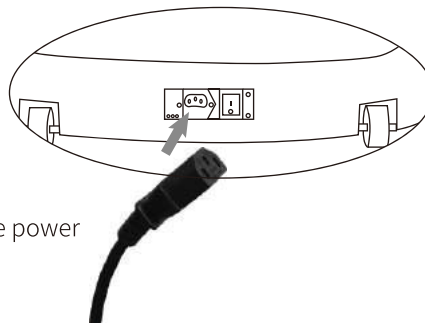

- Plug the cord into the power supply socket.

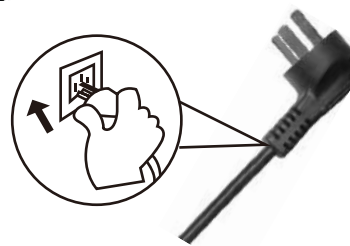

- Plug the other end of the cord into the wall outlet.

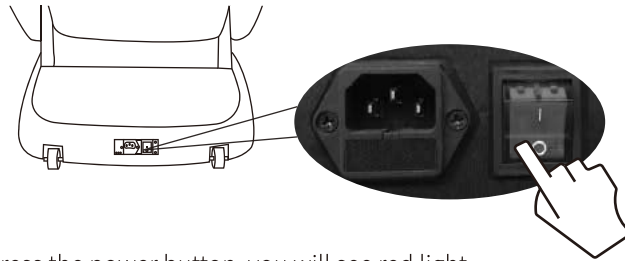

- Press the power button, you will see red light.

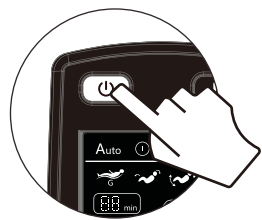

- Start massage according to controller instruction.

Note:

Before switching on the chair, please make sure there is no damage on the power cord and other exposed wires.

Make sure the power switch is off before the chair is connected to electricity.

OFF

- 1 Double check to make sure there is no people, pets or anything within the range of backrest and legrest.

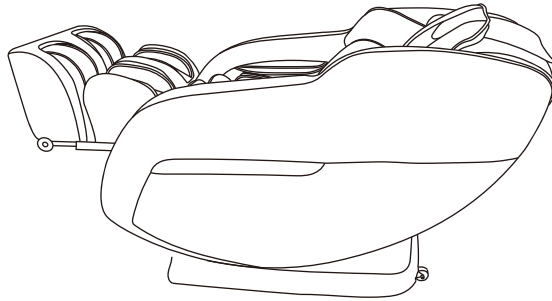

- 2 Press  on the controller to stop massage, wait until the backrest and legrest restore to the original position.

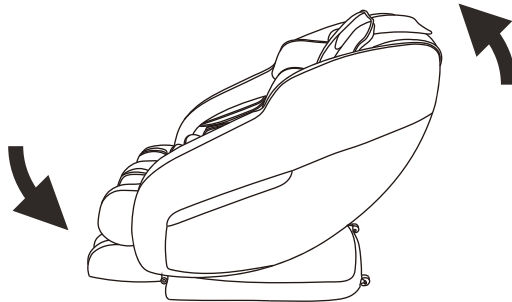

- 3 After chair returns to the upright position, put the remote control back in the pocket.

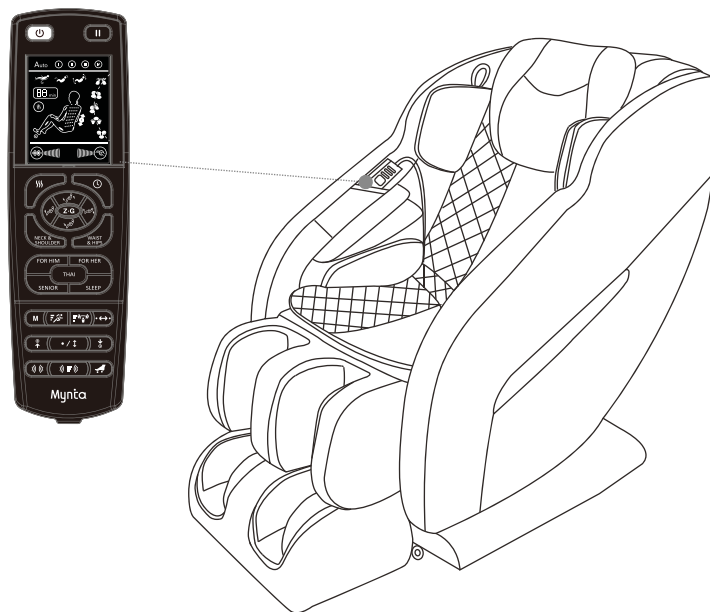

- 4 Switch off the power.

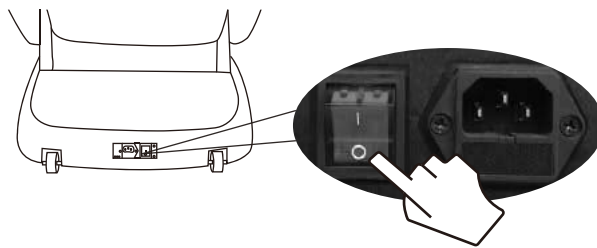

- 5 Unplug the electricity from the socket to avoid any unexpected hurt to children or pets.

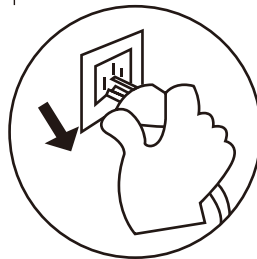

- 6 Clean the chair if necessary.

7 CARE AND MAINTENANCE

STORAGE

Please power off the chair and unplug the chair from the power supply socket when the chair is not in use, to avoid children to start the chair accidentally.

Please disconnect the controller, store the chair carefully if is not in use for a long time.

Do not dismount the hock of the chain.

Keep the massage chair free of dust

Cover the chair with dust-free cloth to prevent dust from collecting.

Do not store in a hot, humid, damp place or in direct sunlight or heat. Do not store in an overly cold places.

MAINTENANCE

Before cleaning, unplug from electrical source to avoid shock.

Synthetic leather

General cleaning

Clean with tidy, soft and dry cloth.(Chemical or medical cleaning products are forbidden)

If Synthetic leather is dirty

- Dip soft cloth into 3-5% neutral detergent solution, squeeze it then clean the stain on the surface gently.
- Wash cloth, squeeze it and wipe with detergent.
- Clean it softly with dry cloth.
- Allow to dry (do not blow dry)



Fabric material

- Dip cloth into weak neutral detergent, squeeze it and clean the material surface.(Diluent, gas, alcohol are prohibited)
- Brush the dirty parts tm with weak neutral detergent.(avoid excessive brushing)



- Excessive cleaning may cause damage to cloth material.
- Wipe with water-dipped but squeezed cloth.
- Allow to dry.



Plastic parts

- Dip cloth into neutral detergent, squeeze it and clean.
- Wipe with water-dipped but squeezed cloth.
- Allow to dry.



Clean the controller

- Wipe with soft cloth after squeezing.
- Allow to dry.
- Propellant, diluent or alcohol are prohibited.



About cleaning

- Before cleaning, unplug the electricity, don't touch plug with wet hands.
- Make sure hands are dry when plugging to the socket.
- Failure to follow these instructions may cause user to experience electric shock.

8 TROUBLESHOOTING GUIDE

KIND REMINDER

During daily use, please check whether the following phenomenon exist:

- If there is scorched smell.
- If the power supply cord gets hot.
- When touch the wire, the power is on, but sometimes off.
- Other abnormal phenomenon.
- If problems happen above, please turn off power supply and contact the distributor or manufacturer for assistance.

TROUBLESHOOTING GUIDE

Problems/Issues	Possible Cause	Troubleshooting
Sounds like tapping or hum sounds	Sounds from air pump motor or other mechanical parts	Normal phenomenon
Sound suddenly becomes much louder while working	<ul style="list-style-type: none"> • Check if it is due to long time working. • Inner parts worn out from long use 	<ul style="list-style-type: none"> • Turn off the power to have the massager rest for over half an hour before next turn working. • Please contact professional technician
Abnormal sounds suddenly while working	Maybe from over working the massage chair	<ul style="list-style-type: none"> • Cut down usage • Contact professional technician
Suddenly stops working	<ul style="list-style-type: none"> • Bad power connection • Auto program timers is up 	<ul style="list-style-type: none"> • Unplug and reinsert power cord to the chair • Normal. Turn off the power to have the massager rest for over half an hour before next turn working

Problems/Issues	Possible Cause	Troubleshooting
Does not work after power up	<ul style="list-style-type: none"> ● Power switch is not turned on ● Bad connection between plug and socket ● Massage remote is not turned on ● Have broken power wire plug ● Bad fuse ● Control unit for functioning properly 	<ul style="list-style-type: none"> ● Turn power switch on ● Connection power cord again ● Press power button on remote ● Contact professional technician ● Replace fuse ● Contact professional technician
Roller height changes	Rollers work alternately	Normal phenomenon
Cannot recline the chair	Obstruction-be sure that the chair is allowed enough room to fully recline	Stop chair operation, and move obstruction.
Neither the backrest nor the legrest can move	Check if there are any obstacles; the chair has safety functions that will shut it down if there is an object blocking normal function.	Remove the obstacles; turn off the power to have the massager rest for over half an hour before next turn working.
Cannot restore position after reclined	Excessive operation; Problem on electric motion pole or plug under bad connection.	Contact professional technician.
Electric wire or plug hot	<ul style="list-style-type: none"> ● It may have overload ● Other abnormal case 	<ul style="list-style-type: none"> ● Turn off the power to have the massager rest for over half an hour before next round working. ● Contact professional technician.

9 PRODUCT SPECIFICATION

Description	Massage Chair
Model	M1610
Rated Input	120V~ 60Hz
Rated Power	150W
Rated Working Time	Approx. 15 minutes(automatic power-off)
Dimension	When it is tilting (H*W*L) 1680mm*760mm*978mm When it isn't tilting (H*W*L) 1450mm*760mm*1110mm
Dimensions of packing box (HxWxL)	1300mm*800mm*1150mm
Net Weight	Approx. 172LBS
Weight(including the packing box)	Approx. 199LBS
Operating Conditions	Ambient temperature: Approx.0°C-35°C Relative humidity: Approx.20%-80%
Storage Conditions	Ambient temperature: Approx.-5°C C-35°C Relative humidity: Approx.20%-80%
Maximum body weight of user	Approx. 120Kg For a user heavier than 100 kilograms, the product may have bigger noise and its fabric may be worn quicker.

10 FCC STATEMENT

FCC STATEMENT

Any Changes or modifications not expressly approved by the party responsible for compliance could void the user's authority to operate the equipment. This device complies with part 15 of the FCC Rules. Operation is subject to the following two conditions:

- This device may not cause harmful interference, and
- This device must accept any interference received, including interference that may cause undesired operation.

EXPOSE STATEMENT

FCC Radiation Exposure Statement:

This equipment complies with FCC radiation exposure limits set forth for an uncontrolled environment. This equipment should be installed and operated with minimum distance 20cm between the radiator & your body.

Note:

This equipment has been tested and found to comply with the limits for a Class B digital device pursuant to part 15 of the FCC Rules. These limits are designed to provide reasonable protection against harmful interference in a residential installation. This equipment generates, uses and can radiate radio frequency energy and, if not installed and used in accordance with the instructions, may cause harmful interference to radio communications.

However, there is no guarantee that interference will not occur in a particular installation. If this equipment does cause harmful interference to radio or television reception, which can be determined by turning the equipment off and on, the user is encouraged to try to correct the interference by one or more of the following measures:

- Reorient or relocate the receiving antenna.
- Increase the separation between the equipment and receiver.
- Connect the equipment into an outlet on a circuit different from that to which the receiver is connected.
- Consult the dealer or an experienced radio/TV technician for help.

Mynta