

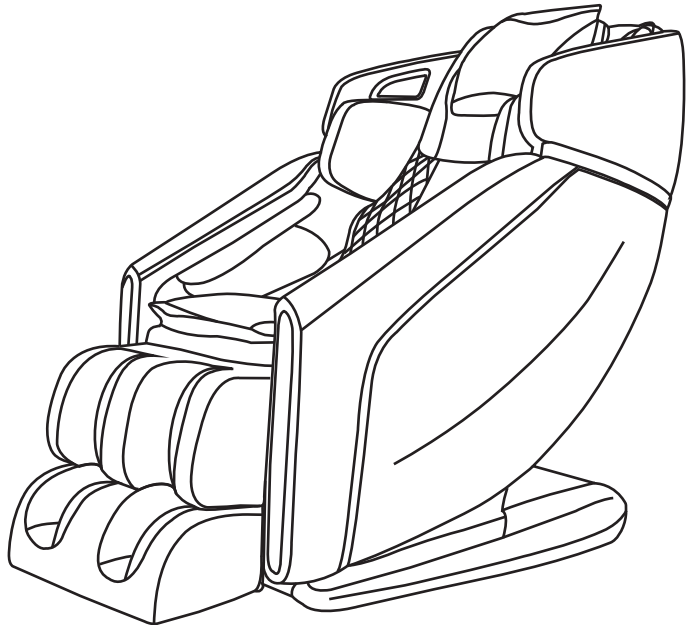

Sensation 4D Massage Chair

Infinite Creative Enterprises, Inc.
Seabrook, New Hampshire



PLEASE BE SURE TO READ THIS MANUAL CAREFULLY TO LEARN THE OPERATIONS OF THIS PRODUCT. DO NOT DISPOSE OF THE MANUAL AND KEEP FOR FUTURE REFERENCE.

IMPORTANT SAFETY INSTRUCTIONS

When using an electrical appliance, basic precautions should always be followed, including the following: Read all instructions before using (this appliance).

DANGER--To reduce the risk of electric shock:

- Always unplug this appliance from the electrical outlet immediately after using and before cleaning.
- Never use pins or other metallic fasteners with this appliance.
- Carefully examine the covering before each use. Discard the appliance if the covering shows any sign of deterioration, such as checking, blistering, or cracking.

- **WARNING**--To reduce the risks of burns, fire, electric shock or injury to persons:
 - An appliance should never be left unattended when plugged in. Unplug from outlet when not in use, and before putting on or taking off parts.
 - Close supervision is necessary when this appliance is used by, on, or near children, or disabled persons.
 - Use this appliance only for its intended use as described in this manual. Do not use attachments that have not been recommended by the manufacturer.
 - Never operate this appliance if it has a damaged cord or plug, if it is not working properly, if it has been dropped or damaged, or dropped into water. Return the appliance to a service center for examination and repair.
 - Do not carry this appliance by the supply cord or use the cord as a handle.
 - Keep the cord away from heated surfaces.
 - Never operate the appliance with the air openings blocked. Keep the air openings free of lint, hair, and the like.
 - Never drop or insert any object into any opening.
 - Do not use outdoors.
 - Do not operate where aerosol (spray) products are being used or where oxygen is being administered.
 - To disconnect, turn all controls to the off position, then remove plug from outlet.
 - Keep children away from the extended foot support.
 - Connect this appliance to a properly grounded outlet only. See Grounding Instructions.
 - Use heated surfaces carefully. May cause serious burns. Do not use over insensitive skin areas or in the presence of poor circulation. The unsupervised use of heat by children or disabled persons may be dangerous.
 - Do not operate under a blanket or pillow. Excessive heating can occur and cause fire, electric shock, or injury to persons.

SAVE THESE INSTRUCTIONS

GROUNDING INSTRUCTIONS

This product must be grounded. If it should malfunction or break down, grounding provides a path of least resistance for the electric current to reduce the risk of electric shock.

This product is equipped with a cord with an equipment-grounding conductor and a grounding plug.

The plug must be plugged into an appropriate outlet that is properly installed and grounded in accordance with all local codes and ordinances.

Danger--Improper connection of the equipment-grounding conductor can result in a risk of electric shock.

Check with a qualified electrician or serviceman if you are in doubt as to whether the product is properly grounded. Do not modify the plug provided with the product - if it will not fit the outlet, have a proper outlet installed by a qualified electrician.

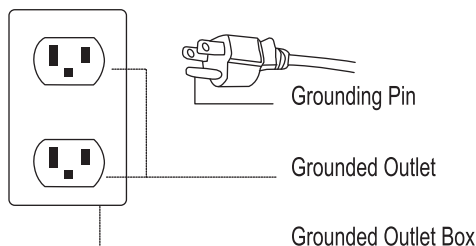

IMPORTANT SAFETY INSTRUCTIONS

OPERATING SURROUNDINGS

- Do not use or store the massage chair in a damp environment : i.e. bathroom, sauna, spa to avoid any mold, electric shock, fire or mechanical failure.
- Do not use the massage chair outdoors
- Do not use the massage chair under dusty, smearable, or anoxic conditions
- Do not place the massage chair near a heater, stove, or near sunlight radiation to avoid inner components overheating and causing fire
- Make sure to place the massage chair on a flat level ground
- The bracket part should be placed on the plain ground
- To avoid electric shock, please make sure to connect an earth wire and have it grounded.
- Don't use the machine while smoking



FOLLOWING CONDITIONS SHOULD CONSULT DOCTORS BEFORE USE

- Suffered from malignant tumor
- Serious heart disease
- Serious skin disease
- Serious boned hyperplasia
- During Pregnancy
- Be on the rest cure under the doctor's supervision
- If there is a bend in the back caused by an accident or disease
- Needing peaceful surroundings
- Arthritis Disease
- Implanted pacemaker for medical purpose
- Suffered from bowels disease (i.e. gastritis, enteritis, diarrhea, hepatitis)
- Serious blood circulation trouble
- Consciousness trouble
- In hyperpyretic

WARNING

Children under the age of 18 or people with disabilities (physical and mental) are not allowed to operate the massage chair without a doctors consent to prevent cases of electric shock, injuries, or mechanism malfunctions.

IMPORTANT SAFETY INSTRUCTIONS

For safety reasons and in order to clearly indicate potential dangers should the product be used improperly, instructions have been marked in the following manners and should be strictly noted.

⊘ CAUTIONS

Non-professional technicians are not allowed to dismantle or repair the chair to avoid fire, electrical shock or serious harm



Do not spray or directly pour liquids to the switch when cleaning to avoid insulation fault, electrical shock or short-circuiting.



When moving the chair in the process of storing or maintenance, be sure to disconnect the power plug from socket

Do not detach the plug with wet hands



Make sure to shut off and detach the power plug when cleaning or storing product

During cleaning or moving the machine, make sure to detach power cord to avoid fire or electrical shock



Do not place the machine onto an unstable surface to avoid roasting, insulation failure, electrical shock or turnover

When storing the machine, make sure to disconnect power plug to avoid fire caused by electricity leaking



Clean power plug periodically to avoid fire due to dust



Do not use it in any unsafe places or for other purposes

It is the main reason of product damage or accident



Do not store the machine onto an unstable surface

Unexpected earthquake or external force will cause damage or injury



Keep supply cord unobstructed at all time, i.e. not twisted, knotted, over flexed or pulled and do not place anything heavy on it



The appliance has a heated surface. Persons insensitive to heat must be careful when using the appliance.



IMPORTANT SAFETY INSTRUCTIONS

⊘ CAUTIONS

Do not modify the structure or change components by unauthorized person

Do not dismantle the machine by unauthorized person to avoid electrical shock, short-circuit or fire



Do not store it near a fire or flammable substances

It is one of the reasons of causing product manipulation, deviation, or damage



Should any abnormality occur(i.e. scorching smell), stop using immediately and detach power plug from socket

Operating under an abnormal situation will cause fire or electrical shock, please contact your local seller or authorized service agent for maintenance



Do not place the machine onto an unstable surface to avoid roast, insulation failure, electrical shock or turnover



Only rated voltage must be used



Stop using immediately if supply cord or power plug be damaged or loosen



Be sure to keep children away during operating to avoid any hazard



Do not explore it under sunshine at all time



If the supply cord is damaged,it must be replaced by the manufacturer or its authorized persons for repair or maintenance to avoid any hazard



IMPORTANT SAFETY INSTRUCTIONS

FCC Radiation Exposure Statement:

This equipment complies with FCC radiation exposure requirement.

Changes or modifications not approved by the party responsible for compliance could void the users authority to operate the equipment.

This equipment has been tested and found to comply with the limits for a Class B digital device, pursuant to part 15 of the FCC Rules.

These limits are designed to provide reasonable protection against harmful interference in a residential installation. This equipment generates, uses and can radiate radio frequency energy and, if not installed and used in accordance with the instructions, may cause harmful interference to radio communications. However, there is no guarantee that interference will not occur in a particular installation.

If this equipment does cause harmful interference to radio or television reception, which can be determined by turning the equipment off and on, the user is encouraged to try to correct the interference by one or more of the following measures:

- Reorient or relocate the receiving antenna.
- Increase the separation between the equipment and receiver.
- Connect the equipment into an outlet on a circuit different from that to which the receiver is connected.
- Consult the dealer or an experienced radio/ TV technician for help.

FCC Radiation Exposure Statement:

This equipment complies with FCC radiation exposure limits set forth for an uncontrolled environment. In order to avoid the possibility of exceeding the FCC radio frequency exposure limits, Human proximity to the antenna shall not be less than 20cm (8 inches) during normal operation.

FUNCTION OF EACH PART

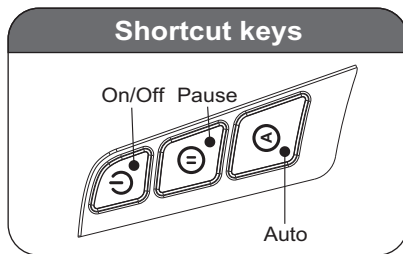
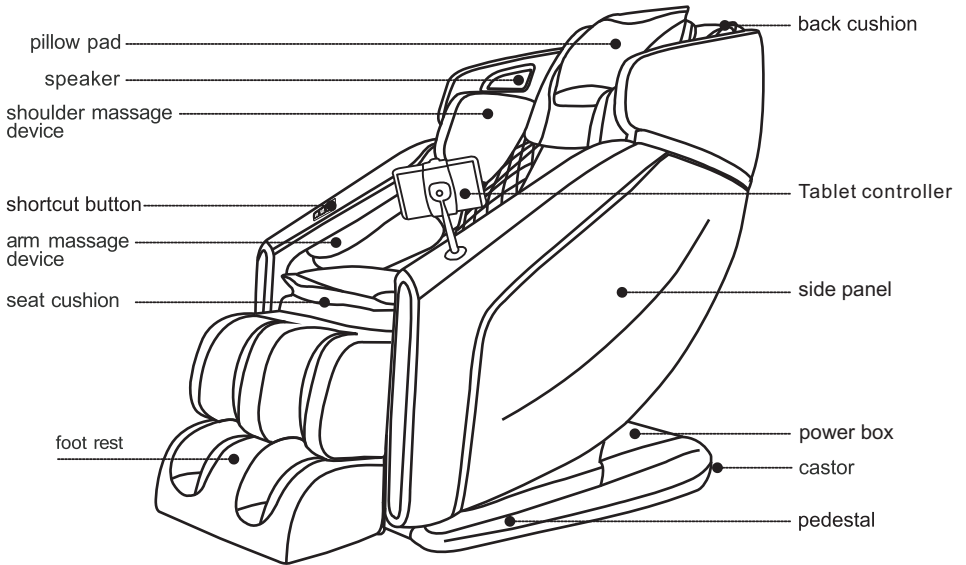

Located on the right side panel

MOVING THE MASSAGE CHAIR

Method 1: Using Casters

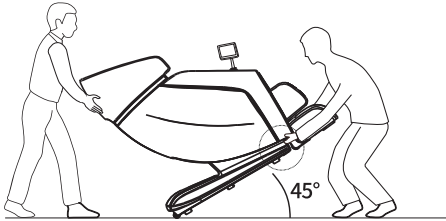

- When moving the chair, one person should tilt the back and the other lift up the footrest to 45 degrees. Then push the chair forward via casters.
- The back should not be reclined too low in case of the chair falling down and causing damage and harm to property or persons.

Method 2: Lift up by two persons and move the chair



- Please grasp the bottom of the side plate (not the base) with your hands and lift it up.
- Due to the heavy weight, the chair must be carried by two or more people. Also please be careful when handling to avoid back strain.



Attention

- Do not drag or push the chair when it is not installed.
- Do not hold the plastic parts of the foot cover and power box for moving. Otherwise, it is easy to cause machine failure or personal injury.
- Do not move the chair when someone is seated. Otherwise, it may cause malfunction or personal injury.
- Before moving the machine, please turn off the chair (backrest & footrest will go back to original position) and unplug the power cord. Otherwise, it may cause malfunction or personal injury.
- It is recommended to lay a cushion on the floor in case of scratching by casters when

CHAIR PLACEMENT

- When placing your massage chair, be sure to leave 6 in. of space between the chair back and wall to allow it to recline safely.
- When using the massage chair, ensure there are no people, pets, or objects within 20 in. of the chair to allow the footrest to extend safely.

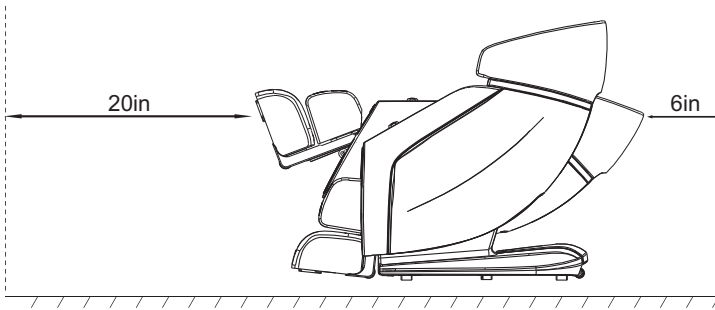

Attention

- Do not use in places with high humidity such as bathrooms or saunas.
- Please use on a flat and non-slippery ground.
- Do not use in a place with a lot of debris or dust, or a place with high surrounding temperature (above 40°C).
- Do not place the unit under direct sunlight or near high-temperature places such as heating appliances.
- Do not let flames such as cigarettes near the massage chair.

Connecting the power cord

- Insert the power cord into the chair's power socket, then plug the cord into a grounded wall outlet.
- Turn the power switch to the ON (I) position.

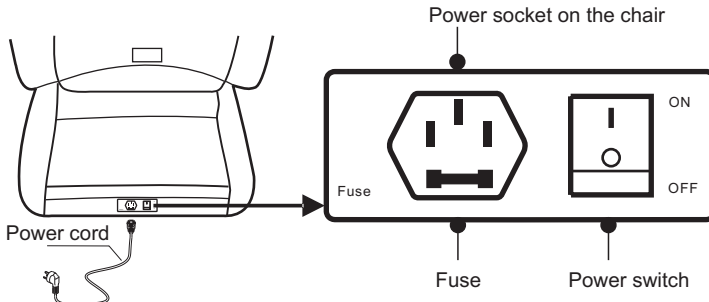

CONTROLLER PANEL



Bluetooth & Music Function

- Open your mobile device Bluetooth function and pair with the chair Bluetooth code “BK8000L”, then you could play the music via speakers.

⚠ Note:

- 1)The connecting password for Bluetooth is “9999” if there is. The default setting is without password.
- 2)The Bluetooth speaker could only connect with one Bluetooth device at a time. Please turn off your Bluetooth device so others could enjoy it as well.

HOW TO USE

1. Turning On the Massage Chair

- ▶ First, be sure the power switch on the power box is in the off "O" position. Then insert the power cable into the port of socket on the left to the switch. Once firmly plugged in, proceed to plug the power cord into the outlet. Then flip the switch to the on "I" position, and the remote should light up.

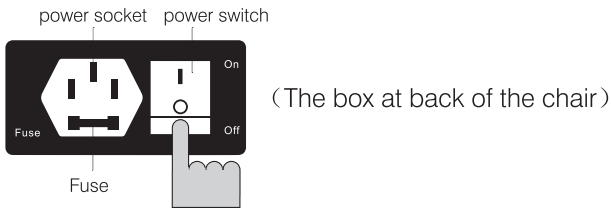







⚠ Warning: Do not insert or pull out the power plug with wet hands, otherwise an electric shock would happen.

2. Starting Your Massage

- ▶ Sit in the chair, then press the power button of controller panel and select a massage.

3. Automatic Massage Program Introduction



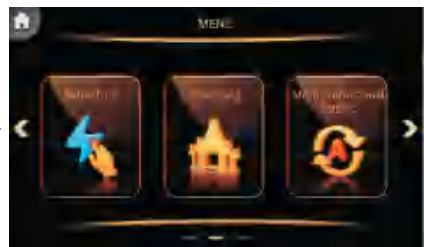
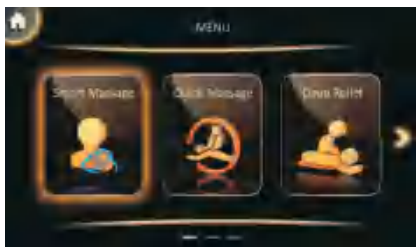

Operation method:

- 1) Press the home page [] key on controller panel to return the main menu.
- 2) Press [ ] key to select Auto program menu, then choose the Auto program to start. The back rollers will detect shoulder position automatically. When you hear "Beeping", the detection is finished, at this moment it allows to press up or down [ ] key to adjust a more accurate shoulder position as you need, then press [] key to start massage.







HOW TO USE



- 3). Lumbar heating: Press [] key to start heating. Press again to close.
- 4). Foot rollers: Press [] to start foot rolling massage. Press again to close
- 5) 4D function adjustment: Press [] or [] to adjust the 4D roller strength. There are total 5 levels adjustments.

Automatic course

Keys	Name	Function
	Smart massage program	* Massage program with kneading, tapping and full body air pressure massage.
	Quick massage program	* Massage program with kneading, tapping and full body air pressure massage with quicker speed.
	Deep Relief massage program	* Massage program with kneading, tapping and full body air pressure massage with slower speed.
	Refreshing massage program	* Slower-paced massage delivers a soothing intensity with full airbag massage.
	Stretching massage program	* Performs a series of grab, hold and stretch sequences while the back and legrest move up and down. Helps with muscle recovery and benefits of stretching

* Automatic massage programs including the following massages. Each program massage different locations: Kneading finger, pressing, beating, soft hammer, and pressure.

HOW TO USE

Automatic course

Keys	Name	Description
 More professional options	All	※ All massage options.
	Theme	※ Specialty program for Office, Phubber, Driver, Housework, Chess.
	Scenes	※ Specialty program for Morning, Afternoon, Night.
	Healthcare	※ Specialty program for Man, Lady, Elderly.
	Age	※ Specialty program for Youth, Middle-aged, Elderly.

※ Above the program massage time by default to 15 minutes, the setting value of the air pressure is moderate, can choose the "strength" key to adjust the pressure intensity.

Massage strength adjustment

► In massage status page, press the key [] to the massage strength page.

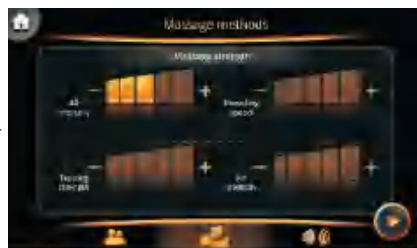
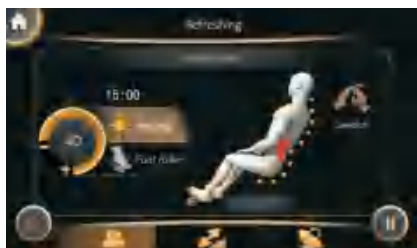

HOW TO USE

Massage angle adjustment

- ▶ In message status page, press the key [] to the message angle adjustment page.

Note: Press the key once to start, press again to stop.



- ▶ In message angle status page, press the key [] to the zero-gravity massage position 1, and press again to the zero gravity massage position 2, press three times to close.

Pause or stop the massage

1) Auto off: The massage chair will stop working automatically after 15 minutes.

All auto programs timer is 15 minutes in default setting.

2) Forced stop: Press the key [] once, the massage chair will stop working.

Press the key [] to re-start massage.

3) End the massage: In the message status page, press the key [] to end the massage.

*Please wait the legrest to return to its original position before standing up to avoid damaging the foot parts due to the whole body's weight.

- ❗ After using the massage chair, please turn off the power switch, and pull the power cord plug out from the power socket.



⚠ Warning: Supervision and guidance is mandatory for those disabled mentally and physically. Please advise with your doctor before using the chair if you have ANY medical conditions. Children under 18 should not use the chair and consult with a doctor for approval if attempted. Do not operate the chair if there are any children or pets near by. Serious injuries may occur if these instructions are not followed.

HOW TO USE

Manual Massage Program

Introduction of manual massage program

Operation method:

- 1) Press the [] home page button to return to main menu.
- 2) Press the [ ] left or right key and choose “Manual massage” . There are different massage methods for your selection, including Kneading, Shiatsu, Swedish, Knocking, Tapping, Rolling.
- 3) Press “Fixedpoint”, “Partial” or “Fullback to choose different massage area.
- 4) Press “Width” to adjust the massage roller width.
- 5) Press “Up” and “Down” key to adjust the massage position
- 6) In “Additional” option, there are “Heat therapy”, Bluetooth music functions.

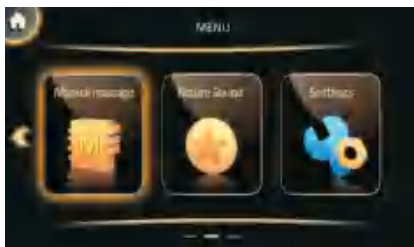
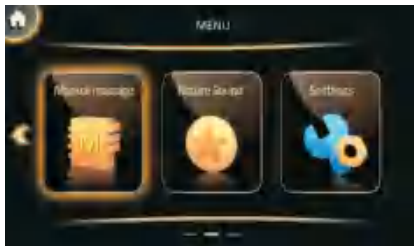















*The manual massage program is a massage program for a partial range of the body.

*The above manual massage programs are all independent programs and cannot be mixed with other programs.

*The initial setting of all the above massage programs is fixed-point massage. Time setting is 15 minutes. The default setting for speed and width is medium. You could adjust as you need.





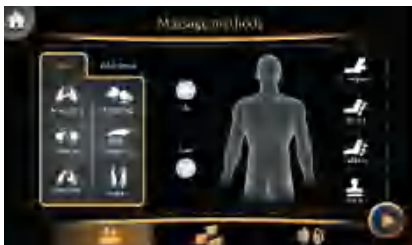

HOW TO USE



Keys	Name	Function
	Full back	Full back massage
	Partial	Massage in a range around 4 in.
	Fixed point	Massage in a fixed point
	Width	Adjust the massage roller width
	Up or Down	Up or down adjustment
	Kneading	Kneading massage
	Knocking	Knocking massage
	Shiatsu	Shiatsu massage
	Tapping	Tapping massage
	Swedish	Swedish massage
	Rolling	Rolling massage
	Heating	Heating on waist
	Bluetooth	Bluetooth speakers for music

7) Press the key [] to air massage option. There are Shoulder, Arm, Leg, Waist, Thigh and Foot for your selection.



HOW TO USE

Keys	Name	Function
	Shoulder	Shoulder air massage
	Waist	Waist air massage
	Arm	Arm air massage
	Thigh	Thigh air massage
	Leg	Leg/Calves air massage
	Foot	Foot air massage

8) Press [ ] key to choose “Nature Sound ” option. There are “White noise、Ocen Surf、Crickets、Rain、Nature、Air Plane、Car Ride、Fireplace、Thunderstorm、Windy Night” ten music to choose.

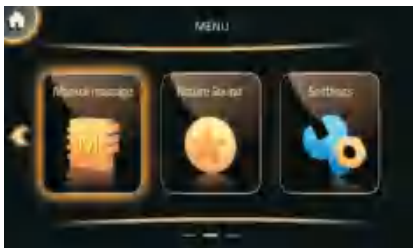

*The above manual massage programs are all independent programs and cannot be mixed with other programs.



*The initial setting of all the above massage programs is fixed-point massage. Time setting is 15 minutes. The default setting for speed and width is medium. You could adjust as you need.

HOW TO USE



Settings function

Introduction of settings key function

Operation method:

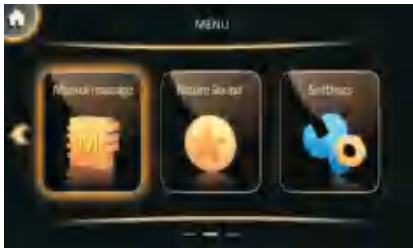
- 1) Press [] home page key to return main menu
- 2) Press [ ] key to choose “settings” option. There are Language, Backlight, Touch-tone, Sleep time, and etc.

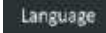
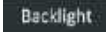

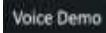
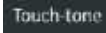
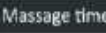
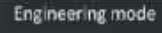
Keys	Name	Function
	Language	Choose different language
	Backlight	Adjust the backlight brightness
	Volume	Adjust the volume
	Voice Demo	Voice Demo On/Off button
	Touch-tone	Touch-tone On/Off button
	Message time	Message time setting including 5/10/15/...30 minutes
	Engineering mode	Engineering mode

SAFETY INSTRUCTIONS

1. Should any abnormality occur, shut off and detach power plug from socket.
2. When the power cord is damaged, it must be changed from a special power cord available from the manufacturer or the service department.



Warning: Do not dismantle, modify, or change components by unauthorized person to avoid electric shock or fire.

DAILY CARE AND MAINTENANCE

Storage guide

- Ⓢ Do not dismantle back of the chair. Electrical shock may happen when in touch with the inner elements of chair.
- Ⓢ An unauthorized person must not dismantle the chair to avoid electric shock or fire.
- Ⓢ Make sure to shut off and detach the power plug when cleaning to avoid electric shock or hazard.
- Ⓢ Keep the massage chair clean and free of dust. Do not place the massage chair in a damp environment.
- Ⓢ If not in use for a long period, please cover it with a cloth to free dust.
- Ⓢ Do not place the massage chair under sunlight.

Maintenance

- Ⓢ Use neutral detergents only
- Ⓢ Use neutral detergents to clean the back cushion, head cushion, and leg cushion. Let it dry.
- Ⓢ Use detergent and cloth to clean the plastic, pipe and leather material of massage chair.
- Ⓢ Make sure not to use organic solvents as gasoline, amyl acetate, benzene for cleaning to avoid fading of the color, aging, or breakage.
- Ⓢ Do not spray pesticide to avoid electric shock or fire.
- Ⓢ Please clean with dry cloth to avoid mechanical failure.

Controller maintenance

- Ⓢ Do not place the massage chair near heat or fire.
- Ⓢ Keep away from dampness to avoid electric shock.
- Ⓢ Please clean dust with a soft cloth or a small banister brush.
- Ⓢ Make sure not to use violent detergent such as benzene, gasoline, amyl acetate.

TROUBLE SHOOTING

Checking is necessary in frequent usage.

Make sure the machine work properly before usage, after not in use for long time.

Abnormality situation	Solution guide
Failure to start and indicator light is off	<ul style="list-style-type: none"> Ⓒ Check that the plug is well connected Ⓒ Check if the switch on the chair is turned to "I" position
Sound in operation	<p>The sound is normal in following situation</p> <ul style="list-style-type: none"> Ⓒ Sound for kneading or knocking Ⓒ Sound changes after speed adjustment Ⓒ Sound from the box in massage Ⓒ Vibration sound for backrest in massage Ⓒ Sound for air input and output Ⓒ Sound for airbag inflating and venting Ⓒ Sound for leg adjustment Ⓒ Sound for motor when the massage chair is loaded

SPECIFICATION

Product name	Massage Chair
Model	Sensation 4D
Power supply	120V~ 60Hz
Rated power	150W
Rated working time	15 min