

TEST REPORT



DT&C Co., Ltd.

42, Yurim-ro, 154Beon-gil, Cheoin-gu, Yongin-si, Gyeonggi-do, Korea, 17042
Tel : 031-321-2664, Fax : 031-321-1664

1. Report No : DRTFCC2109-0091(1)

2. Customer

- Name (FCC) : AMOSENSE Co., Ltd. / Name (IC) : AMOSENSE CO.,LTD.
- Address (FCC) : 19-1BL, 90, 4sandan 5-gil, Jiksan-eup, Cheonan-si, Seobuk-gu, Chungcheongnam-do, South Korea
- Address (IC) : 19-1BL, 90, 4sandan 5-gil, Jiksan-eup Cheonan-si Chungcheongnam-do 31040 Korea (Republic Of)

3. Use of Report : FCC & IC Certification

4. Product Name / Model Name : UNIT ASSY-ULTRA WIDEBAND / ASUWBMT0
FCC ID : 2AS9T-ASUWBMT
IC : 27298-ASUWBMT

5. FCC Regulation(s): Part 15 Subpart F
IC Standard(s): RSS-220 Issue 1
Test Method used: ANSI C63.10-2013



6. Date of Test : 2021.07.01 ~ 2021.08.19

7. Location of Test : Permanent Testing Lab On Site Testing

8. Testing Environment : See appended test report.

9. Test Result : Refer to the attached test result.

The results shown in this test report refer only to the sample(s) tested unless otherwise stated.
This test report is not related to KOLAS accreditation.

Affirmation	Tested by	Reviewed by
	Name : JaeHyeok Bang 	Name : JaeJin Lee  (Signature)

2021 . 09 . 17 .

DT&C Co., Ltd.

If this report is required to confirmation of authenticity, please contact to report@dtnc.net

Test Report Version

Test Report No.	Date	Description	Revised by	Reviewed by
DRTFCC2109-0091	Sep, 03. 2021	Initial issue	JaeHyeok Bang	JaeJin Lee
DRTFCC2109-0091(1)	Sep, 17. 2021	Add the FCC rule	JaeHyeok Bang	JaeJin Lee

Table of Contents

1. General Information	4
1.1. Description of EUT	4
1.2. Declaration by the applicant / manufacturer	4
1.3. Testing Laboratory	5
1.4. Testing Environment.....	5
1.5. Measurement Uncertainty.....	5
1.6. Test Equipment List	6
2. Test Methodology	7
2.1. EUT Configuration	7
2.2. EUT Exercise.....	7
2.3. General Test Procedures	7
2.4. Instrument Calibration	7
2.5. Description of Test Modes.....	7
3. Antenna Requirements	8
4. Summary of Test Result	9
5. Test Result	10
5.1. - 10dB Bandwidth	10
5.2. EIRP (Equivalent Isotropically Radiated Power)	12
5.3. Unwanted Emissions	14
5.3.1. Unwanted Emissions(Below 960 MHz)	14
5.3.2. Unwanted Emissions(Above 960 MHz).....	18
5.4. AC Power-Line Conducted Emissions	24
5.5. Cease Transmission Time	25
5.6. Occupied Bandwidth.....	27
APPENDIX I	29

1. General Information

1.1. Description of EUT

Equipment Class	Ultra Wideband Transmitter (UWB)
Product Name	UNIT ASSY-ULTRA WIDEBAND
Model Name	ASUWBMT0
Add Model Name	-
Firmware Version Identification Number	B.02
EUT Serial Number	No specified
Power Supply	DC 12 V
Frequency Range	6.489 6 GHz ~ 7.987 2 GHz
Max. RF Output Power	-9.81 dBm (Peak) / 40 MHz
Modulation Technique	BPM-BPSK
Antenna Specification	Internal Antenna Gain: 2.42 dBi (PK)

1.2. Declaration by the applicant / manufacturer

N/A

1.3. Testing Laboratory

DT&C Co., Ltd.		
The 3 m test site and conducted measurement facility used to collect the radiated data are located at the 42, Yurim-ro, 154beon-gil, Cheoin-gu, Yongin-si, Gyeonggi-do, Korea 17042. The site is constructed in conformance with the requirements.		
- FCC & IC MRA Designation No. : KR0034		
- ISED #: 5740A		
www.dtnc.net		
Telephone	:	+ 82-31-321-2664
FAX	:	+ 82-31-321-1664

1.4. Testing Environment

Ambient Condition	
• Temperature	+20 °C ~ +24 °C
• Relative Humidity	+40 % ~ +43 %

1.5. Measurement Uncertainty

The measurement uncertainties shown below were calculated in accordance with requirements of ANSI C63.4-2014 and ANSI C63.10-2013. All measurement uncertainty values are shown with a coverage factor of $k = 2$ to indicate a 95 % level of confidence.

Parameter	Measurement uncertainty
AC power-line conducted emission	3.4 dB (The confidence level is about 95 %, $k = 2$)
Radiated emission (1 GHz Below)	4.9 dB (The confidence level is about 95 %, $k = 2$)
Radiated emission (1 GHz ~ 18 GHz)	5.0 dB (The confidence level is about 95 %, $k = 2$)
Radiated emission (18 GHz Above)	5.3 dB (The confidence level is about 95 %, $k = 2$)

1.6. Test Equipment List

Type	Manufacturer	Model	Cal.Date (yy/mm/dd)	Next.Cal.Date (yy/mm/dd)	S/N
Spectrum Analyzer	Rohde Schwarz	FSW85	20/12/16	21/12/16	101530
Spectrum Analyzer	Agilent	N9020A	20/12/16	21/12/16	MY50410399
DC Power supply	SM techno	SDP30-5D	21/06/24	22/06/24	305DNF079
Multimeter	FLUKE	17B+	20/12/16	21/12/16	36390701WS
Thermohygrometer	BODYCOM	BJ5478	21/06/24	22/06/24	N/A
Signal Generator	Rohde Schwarz	SMBV100A	20/12/16	21/12/16	255571
Signal Generator	ANRITSU	MG3695C	20/12/16	21/12/16	173501
Loop Antenna	ETS-Lindgren	6502	21/01/28	23/01/28	00226186
Bilog Antenna	Schwarzbeck	VULB 9160	20/12/16	21/12/16	9160-3362
HORN ANT	ETS	3117	20/12/16	21/12/16	00140394
HORN ANT	A.H.Systems Inc.	SAS-574	21/06/24	22/06/24	154
PreAmplifier	H.P	8447D	20/12/16	21/12/16	2944A07774
PreAmplifier	Agilent	8449B	21/06/24	22/06/24	3008A02108
PreAmplifier	tsj	MLA-1840-J02-45	21/06/24	22/06/24	16966-10728
Power Divider	Weinschel	1515-1	21/06/24	22/06/24	TA377
Attenuator	Aeroflex/Weinschel	86-20-11	21/06/24	22/06/24	432
Cable	HUBER+SUHNER	SUCOFLEX100	21/01/08	22/01/08	M-1
Cable	HUBER+SUHNER	SUCOFLEX100	21/01/08	22/01/08	M-2
Cable	JUNFLON	MWX241/B	21/01/08	22/01/08	M-3
Cable	JUNFLON	J12J101757-00	21/01/08	22/01/08	M-7
Cable	HUBER+SUHNER	SUCOFLEX106	21/01/08	22/01/08	M-9
Cable	Junkosha	MWX241	21/01/08	22/01/08	mmW-1
Cable	Junkosha	MWX342	21/01/08	22/01/08	mmW-2
Cable	Junkosha	MWX241	21/01/08	22/01/08	mmW-4
Cable	Junkosha	MWX342	21/01/08	22/01/08	mmW-11
Cable	DTNC	Cable	21/01/05	22/01/05	RFC-44
Cable	DTNC	Cable	21/01/05	22/01/05	RFC-45

Note1: The measurement antennas were calibrated in accordance to the requirements of ANSI C63.5-2017.

Note2: The cable is not a regular calibration item, so it has been calibrated by DT & C itself.

2. Test Methodology

The measurement procedures described in the ANSI C63.10-2013 was used in measurement of the EUT.

2.1. EUT Configuration

The EUT configuration for testing is installed on RF field strength measurement to meet the Commissions requirement and operating in a manner that intends to maximize its emission characteristics in a continuous normal application.

2.2. EUT Exercise

The EUT was operated in the test mode to fix the TX frequency that was for the purpose of the measurements. According to its specifications, the EUT must comply with the requirements of the FCC rules.

2.3. General Test Procedures

Conducted Emissions

According to requirements in Section 6.2 of ANSI C63.10-2013, the EUT is placed on the wooden table, which is 0.8 m above ground plane and the conducted emissions from the EUT measured in the frequency range between 0.15 MHz and 30 MHz using CISPR Quasi-peak and Average detector.

Radiated Emissions

The EUT is placed on a non-conductive table. For emission measurements at or below 960 MHz, the table height is 80 cm. For emission measurements above 960 MHz, the table height is 1.5 m. The turntable shall rotate 360 degrees to determine the position of maximum emission level. EUT is set 3 m away from the receiving antenna, which varied from 1 m to 4 m to find out the highest emission. And also, each emission was to be maximized by changing the polarization of receiving antenna both horizontal and vertical.

2.4. Instrument Calibration

The measuring equipment, which was utilized in performing the tests documented herein, has been calibrated in accordance with the manufacturer's recommendations for utilizing calibration equipment, which is traceable to recognized national standards.

2.5. Description of Test Modes

The EUT has been tested with the operating condition for maximizing the emission characteristics.

EUT Operation test setup

- The internal firmware was used for staying in continuous transmitting mode.
- Power setting: default

Tested Frequency (MHz)	
6 489.6	7 987.2

*This device supports two channels.(CH.5: 6 489.6 MHz, CH.9: 7 987.2 MHz)

3. Antenna Requirements

Part 15.203

“An intentional radiator antenna shall be designed to ensure that no antenna other than that furnished by the responsible party can be used with the device. The use of a permanently attached antenna or of an antenna that uses a unique coupling to the intentional radiator shall be considered sufficient to comply with the provisions of this section.”

The antenna is permanently attached on the device.

Therefore this E.U.T complies with the requirement of Part 15.203

4. Summary of Test Result

FCC part section(s)	RSS section(s)	Test Description	Limit	Test Condition	Status Note 1
15.503 15.519(b)	RSS-220[2], RSS-220[5.1]	- 10 dB Bandwidth	- 10 dB bandwidth > 500 MHz or - 10 dB fractional bandwidth >0.2 Within the 3.1 – 10.6 GHz	Radiated	C
15.519(e) 15.521(e) 15.521(g)	RSS-220[5.3.1]	EIRP(Equivalent Isotropically Radiated Power)	Peak eirp < 20 log (RBW/50) dBm		C Note2
15.519(c) 15.521(c) 15.521(d) 15.521(h) 15.209	RSS-220[5.3.1] RSS-220[3.4]	Unwanted Emissions (at or below 960 MHz)	Part 15.209 RSS-220[3.4] (Refer to section 5.3)		C Note2
15.519(c), (d) 15.521(c) 15.521(d) 15.521(h)	RSS-220[5.3.1]	Unwanted Emissions (above 960 MHz)	Part 15.519(c), (d) RSS-220[5.3.1] (Refer to section 5.3)		C Note2
-	RSS-Gen[6.7]	Occupied Bandwidth (99%)	NA	Conducted	C
15.519(a)(1)	RSS-220[5.3.1]	Cease Transmission Time	Part 15.519(a)(1) RSS-220[5.3.1](b) (Refer to section 5.5)		C
15.521(j) 15.207	RSS-220[5.2.1]	AC Power-Line Conducted Emissions	Part 15.207 RSS-Gen[8.8] (Refer to Section 5.4)	AC Line Conducted	NA Note3
15.203	-	Antenna Requirements	Part 15.203 (Refer to Section 5.6)	-	C

Note 1: **C**=Comply **NC**=Not Comply **NT**=Not Tested **NA**=Not Applicable
 Note 2: This test item was performed in three orthogonal EUT positions and the worst case data was reported.
 Note 3: This device is installed in a car. Therefore the power source is a battery of car.

5. Test Result

5.1. - 10dB Bandwidth

▣ Test Requirements and limit

Part 15.503(d)

Ultra-wideband (UWB) transmitter. An intentional radiator that, at any point in time, has a fractional bandwidth equal to or greater than 0.20 or has a UWB bandwidth equal to or greater than 500 MHz, regardless of the fractional bandwidth.

Part 15.519(b)

The UWB bandwidth of a device operating under the provisions of this section must be contained between 3100 MHz and 10,600 MHz.

RSS-220[2]

A UWB device is an intentional radiator that has either a -10 dB bandwidth¹ of at least 500 MHz or a -10 dB fractional bandwidth² greater than 0.2. There are eight distinct subclasses of UWB device.

RSS-220[5.1](a)

The -10 dB bandwidth of the device shall be totally contained in the band 3.1-10.6 GHz.

▣ Test Configuration

Refer to the APPENDIX I.

▣ Test Procedure

ANSI C63.10-2013 Section 10.1

The frequency at which the maximum power level is measured with the peak detector is designated f_M . The peak power measurements shall be made using a spectrum analyzer or EMI receiver with a 1 MHz resolution bandwidth and a video bandwidth of 1 MHz or greater. The instrument shall be set to peak detection using the maximum-hold trace mode. The outermost 1 MHz segments above and below f_M , where the peak power falls by 10 dB relative to the level at f_M , are designated as f_H and f_L , respectively:

- For the lowest frequency bound f_L , the emission is searched from a frequency lower than f_M that has, by inspection, a peak power much lower than 10 dB less than the power at f_M and increased toward f_M until the peak power indicates 10 dB less than the power at f_M . The frequency of that segment is recorded.
- This process is repeated for the highest frequency bound f_H , beginning at a frequency higher than f_M that has, by inspection, a peak power much lower than 10 dB below the power at f_M . The frequency of that segment is recorded.
- The two recorded frequencies represent the highest f_H and lowest f_L bounds of the UWB transmission, and the -10 dB bandwidth ($B - 10$) is defined as $(f_H - f_L)$. The center frequency (f_c) is mathematically determined from $(f_H + f_L) / 2$.
- The fractional bandwidth is defined as $2(f_H - f_L) / (f_H + f_L)$.
- Determine whether the -10 dB bandwidth $(f_H - f_L)$ is ≥ 500 MHz, or whether the fractional bandwidth $2(f_H - f_L) / (f_H + f_L)$ is ≥ 0.2 .

Test Results: **Comply**

Tested Frequency (MHz)	f_L (MHz)	f_H (MHz)	-10dB Bandwidth(MHz)
6 489.6	6 192.15	6 787.36	595.21
7 987.2	7 713.04	8 276.26	563.22

-10dB Bandwidth

Tested Frequency(MHz): 6 489.6

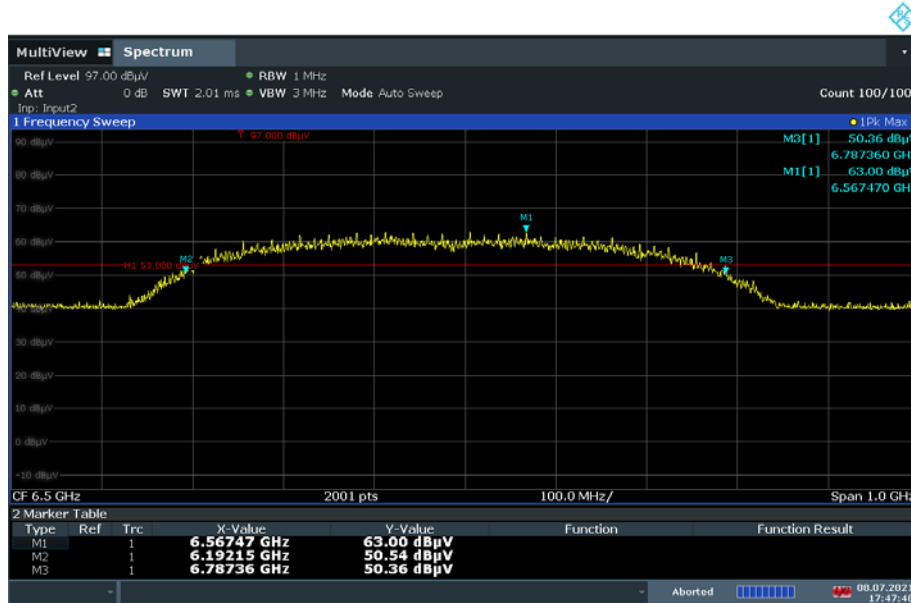

-10dB Bandwidth

Tested Frequency(MHz): 7 987.2

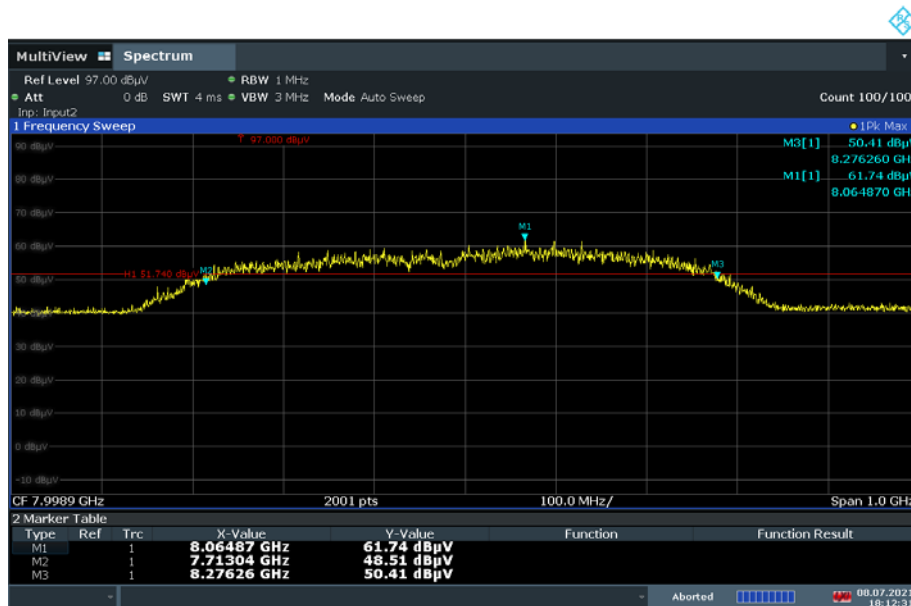

5.2. EIRP (Equivalent Isotropically Radiated Power)

■ Test Requirements and limit

Part 15.519(e)

There is a limit on the peak level of the emissions contained within a 50 MHz bandwidth centered on the frequency at which the highest radiated emission occurs, f_M . That limit is 0 dBm EIRP. It is acceptable to employ a different resolution bandwidth, and a correspondingly different peak emission limit, following the procedures described in §15.521.

Part 15.521(e)

The frequency at which the highest radiated emission occurs, f_M , must be contained within the UWB bandwidth.

Part 15.521(g)

When a peak measurement is required, it is acceptable to use a resolution bandwidth other than the 50 MHz specified in this subpart. This resolution bandwidth shall not be lower than 1 MHz or greater than 50 MHz, and the measurement shall be centered on the frequency at which the highest radiated emission occurs, f_M . If a resolution bandwidth other than 50 MHz is employed, the peak EIRP limit shall be $20 \log(RBW/50)$ dBm where RBW is the resolution bandwidth in megahertz that is employed. This may be converted to a peak field strength level at 3 meters using $E(\text{dBuV/m}) = P(\text{dBm EIRP}) + 95.2$. If RBW is greater than 3 MHz, the application for certification filed with the Commission must contain a detailed description of the test procedure, calibration of the test setup, and the instrumentation employed in the testing.

RSS-220[5.3.1]

The peak level of the transmissions shall not exceed the peak equivalent of the average limit contained within any 50 MHz bandwidth, as defined in section 4 of the Annex.

■ Test Configuration

Refer to the APPENDIX I.

■ Test Procedure:

ANSI C63.10-2013 Section 6.6 & 10.1

- 1) These measurements were performed at 3 m test site.
- 2) The equipment under test is placed on a non-conductive table 1.5-meters above a turntable which is flush with the ground plane and 3 meters from the receive antenna.
- 3) For measurements above 1GHz absorbers are placed on the floor between the turn table and the antenna mast in such a way so as to maximize the reduction of reflections.
- 4) The antenna is a broadband antenna, and its height is varied from one meter to four meters above the ground to determine the maximum value of the field strength. Both horizontal and vertical polarizations of the antenna are set to make the measurement.
- 5) For each suspected emission, the EUT was arranged to its worst case and then the antenna was tuned to heights from 1 meter to 4 meters and the table was turned from 0 degrees to 360 degrees to find the maximum reading.

Instrument setting

For peak eirp measurement

1. Set the RBW $\geq 1 \sim 50$ MHz (Actual: 40 MHz)
2. Set VBW \geq RBW
3. Detector = peak
4. Trace mode = max hold
5. Allow trace to fully stabilize

Test Results: Comply

- Test Notes

1. Sample Calculation

$EIRP (dBm) = E (dB\mu V/m) + 20\log(D) - 104.7$; where D is the measurement distance in m.

$E(dB\mu V/m) = \text{Measured level (dB}\mu V) + TF(dB/m)$

where, E = field strength, TF = Total Factor, TF = Antenna Factor(dB/m) + Cable Loss(dB) – Amplifier Gain(dB)

3. Peak eirp limit = $20 \times \log(RBW/50) = -1.94 \text{ dBm}$

4. The highest radiated emission is within the UWB bandwidth.

Peak eirp

Tested frequency (MHz)	Frequency (MHz)	ANT Pol	Measured Level(dBuV)	TF (dB/m)	E (dBuV/m)	EIRP (dBm)	Limit (dBm)	Margin (dB)
6 489.6	6 427.18	H	76.80	8.55	85.35	-9.81	-1.94	7.87
7 987.2	8 047.65	H	75.69	9.65	85.34	-9.82	-1.94	7.88

Plot(Measured Level)

6 489.6 MHz & X axis & Hor

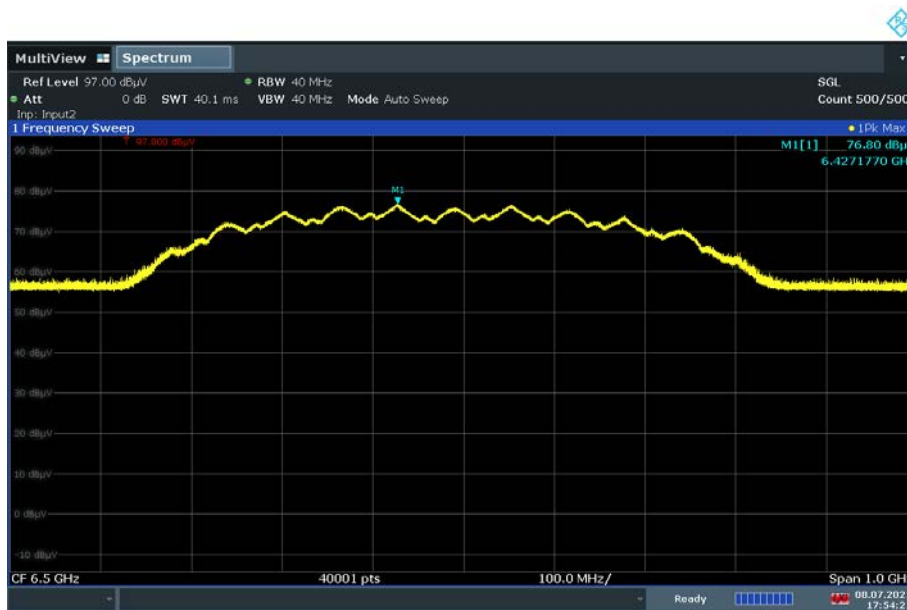

Plot(Measured Level)

7 987.2 MHz & X axis & Hor

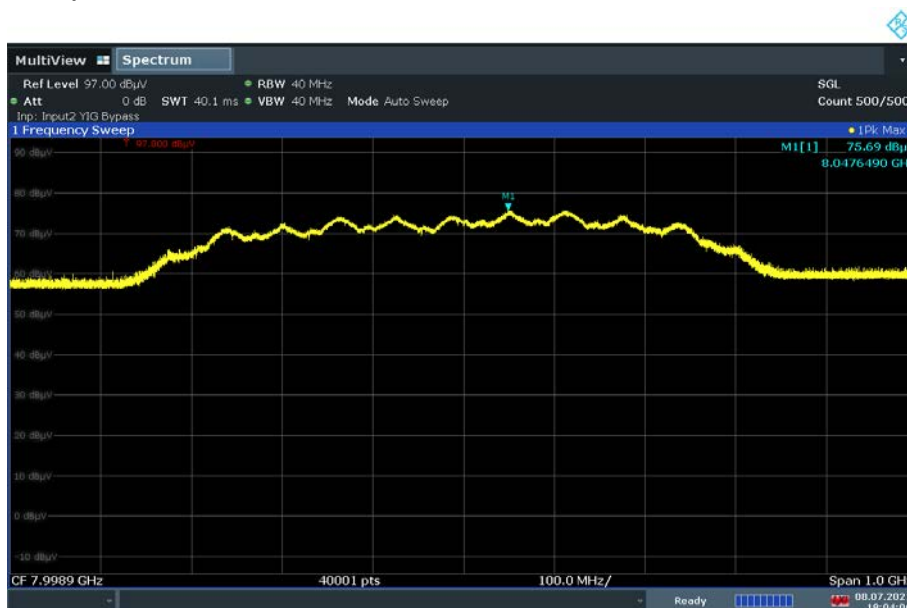

5.3. Unwanted Emissions

5.3.1. Unwanted Emissions(Below 960 MHz)

■ Test Requirements and limit

Part 15.519(c)

The radiated emissions at or below 960 MHz from a device operating under the provisions of this section shall not exceed the emission levels in §15.209.

Part 15.521(c)

Emissions from digital circuitry used to enable the operation of the UWB transmitter shall comply with the limits in § 15.209, rather than the limits specified in this subpart, provided it can be clearly demonstrated that those emissions from the UWB device are due solely to emissions from digital circuitry contained within the transmitter and that the emissions are not intended to be radiated from the transmitter's antenna. Emissions from associated digital devices, as defined in § 15.3(k), e.g., emissions from digital circuitry used to control additional functions or capabilities other than the UWB transmission, are subject to the limits contained in Subpart B of this part.

Part 15.521(d)

Within the tables in §§ 15.509, 15.511, 15.513, 15.515, 15.517, and 15.519, the tighter emission limit applies at the band edges. Radiated emission levels at and below 960 MHz are based on measurements employing a CISPR quasi-peak detector. Radiated emission levels above 960 MHz are based on RMS average measurements over a 1 MHz resolution bandwidth. The RMS average measurement is based on the use of a spectrum analyzer with a resolution bandwidth of 1 MHz, an RMS detector, and a 1 millisecond or less averaging time. Unless otherwise stated, if pulse gating is employed where the transmitter is quiescent for intervals that are long compared to the nominal pulse repetition interval, measurements shall be made with the pulse train gated on. Alternative measurement procedures may be considered by the Commission.

Part 15.521(h)

The highest frequency employed in § 15.33 to determine the frequency range over which radiated measurements are made shall be based on the center frequency, f_c , unless a higher frequency is generated within the UWB device. For measuring emission levels, the spectrum shall be investigated from the lowest frequency generated in the UWB transmitter, without going below 9 kHz, up to the frequency range shown in § 15.33(a) or up to $f_c + 3/(\text{pulse width in seconds})$, whichever is higher. There is no requirement to measure emissions beyond 40 GHz provided f_c is less than 10 GHz; beyond 100 GHz if f_c is at or above 10 GHz and below 30 GHz; or beyond 200 GHz if f_c is at or above 30 GHz.

Part 15.209

Part 15.209(a) Except as provided elsewhere in this subpart, the emissions from an intentional radiator shall not exceed the field strength levels specified in the following table:

Frequency (MHz)	FCC Limit (uV/m)	Measurement Distance (m)
0.009 - 0.490	2 400 / F (kHz)	300
0.490 - 1.705	2 4000 / F (kHz)	30
1.705 - 30.0	30	30

Frequency (MHz)	FCC Limit (uV/m)	Measurement Distance (m)
30 - 88	100 **	3
88 - 216	150 **	3
216 - 960	200 **	3
Above 960	500	3

**Except as provided in paragraph (g), fundamental emissions from intentional radiators operating under this section shall not be located in the frequency bands 54-72 MHz, 76-88 MHz, 174-216 MHz or 470-806 MHz. However, operation within these frequency bands is permitted under other sections of this part, e.g., §§15.231 and 15.241.

RSS-220[5.3.1](c)

Radiated emissions at or below 960 MHz from a device shall not exceed the limits in section 3.4.

RSS-220[3.4]

Radiated emissions at or below 960 MHz for all subclasses of UWB device shall not exceed the following limits. Measurements of radiated emissions at and below 960 MHz are to be made using a CISPR quasi-peak detector. CISPR measurement bandwidth specifications are to be used.

Frequency (MHz)	Field Strength Limit (uV/m)	Measurement Distance (m)	E.i.r.p. Limit (dBm W)
0.009 - 0.490	2 400 / F (kHz)	300	10 log (17.28 / F ²) (F in kHz)
0.490 - 1.705	2 4000 / F (kHz)	30	10 log (17.28 / F ²) (F in kHz)
1.705 - 30.0	30	30	-45.7
30 - 88	100	3	-55.2
88 - 216	150	3	-51.7
216 - 960	200	3	-49.2

Note: The emission limits for the bands 9-90 kHz and 110-490 kHz are based on measurements employing an average emissions detector.

■ **Test Configuration**

Refer to the APPENDIX I.

■ **Test Procedure**

ANSI C63.10-2013 Section 6.4 & 6.5

- 1) These measurements were performed at 3 m test site.
- 2) The equipment under test is placed on a non-conductive table 0.8 meters above a turntable which is flush with the ground plane and 3 meters from the receive antenna.
- 3) The antenna is a broadband antenna, and its height is varied from one meter to four meters above the ground to determine the maximum value of the field strength. Both horizontal and vertical polarizations of the antenna are set to make the measurement.
- 4) For each suspected emission, the EUT was arranged to its worst case and then the antenna was tuned to heights from 1 meter to 4 meters and the table was turned from 0 degrees to 360 degrees to find the maximum reading.

Instrument setting:

RBW = As specified in below table, VBW ≥ 3 x RBW, Sweep = Auto, Detector = Peak or quasi-peak

(Note: Measurements were performed using the peak detector. The data measured using the peak detector of a spectrum analyzer or EMI receiver will represent the worst-case results.)

Trace mode = Max Hold until the trace stabilizes.

Frequency	RBW
9 - 150 kHz	200 – 300 Hz
0.15- 30 MHz	9 – 10 kHz
30 – 1 000 MHz	100 – 120 kHz
> 1000 MHz	1 MHz

■ **Test Results: Comply**

- Test Notes

1. The worst case data was reported. No other spurious and harmonic emissions were found below listed frequencies.
2. Information of Distance Correction Factor (DCF)
 - For finding emissions, measurements may be performed at a distance closer than that specified in the regulations. In this case, the distance factor is applied to the result.
 - Calculation of distance correction factor
 - At frequencies below 30 MHz = $40 \log(\text{tested distance} / \text{specified distance})$
 - At frequencies at or above 30 MHz = $20 \log(\text{tested distance} / \text{specified distance})$
 - When distance factor is "N/A", the measurements were performed at the specified distance and distance factor is not applied.
3. Sample Calculation.
 - Margin = Limit – Result / Result = Reading + TF + DCF / TF = AF + CL – AG
 - Where, TF = Total Factor, AF = Antenna Factor, CL = Cable Loss, AG = Amplifier Gain
4. * = Noise floor

Tested frequency: 6 489.6 MHz

Frequency (MHz)	ANT Pol	Detector Mode	Measured Level(dBuV)	TF (dB/m)	DCF (dB)	Result (dBuV/m)	Limit (dBuV/m)	Margin (dB)
34.850	V	PK	31.30	-10.40	NA	20.90	40.00	19.10
41.640	V	PK	29.70	-9.50	NA	20.20	40.00	19.80
69.770	V	PK	33.00	-11.20	NA	21.80	40.00	18.20
*904.929	H	PK	25.30	4.10	NA	29.40	46.00	16.60
*924.328	V	PK	25.20	4.60	NA	29.80	46.00	16.20
-	-	-	-	-	-	-	-	-

5.3.2. Unwanted Emissions(Above 960 MHz)

■ Test Requirements and limit

Part 15.519(c)

The radiated emissions above 960 MHz from a device operating under the provisions of this section shall not exceed the following average limits when measured using a resolution bandwidth of 1 MHz:

Frequency in MHz	EIRP in dBm
960 – 1 610	-75.3
1 610 – 1 990	-63.3
1 990 – 3 100	-61.3
3 100 – 10 600	-41.3
Above 10 600	-61.3

Part 15.519(d)

In addition to the radiated emission limits specified in the table in paragraph (c) of this section, UWB transmitters operating under the provisions of this section shall not exceed the following average limits when measured using a resolution bandwidth of no less than 1 kHz:

Frequency in MHz	EIRP in dBm
1 164 - 1 240	-85.3
1 559 - 1 610	-85.3

Part 15.521(c)

Emissions from digital circuitry used to enable the operation of the UWB transmitter shall comply with the limits in § 15.209, rather than the limits specified in this subpart, provided it can be clearly demonstrated that those emissions from the UWB device are due solely to emissions from digital circuitry contained within the transmitter and that the emissions are not intended to be radiated from the transmitter's antenna. Emissions from associated digital devices, as defined in § 15.3(k), e.g., emissions from digital circuitry used to control additional functions or capabilities other than the UWB transmission, are subject to the limits contained in Subpart B of this part.

Part 15.521(d)

Within the tables in §§ 15.509, 15.511, 15.513, 15.515, 15.517, and 15.519, the tighter emission limit applies at the band edges. Radiated emission levels at and below 960 MHz are based on measurements employing a CISPR quasi-peak detector. Radiated emission levels above 960 MHz are based on RMS average measurements over a 1 MHz resolution bandwidth. The RMS average measurement is based on the use of a spectrum analyzer with a resolution bandwidth of 1 MHz, an RMS detector, and a 1 millisecond or less averaging time. Unless otherwise stated, if pulse gating is employed where the transmitter is quiescent for intervals that are long compared to the nominal pulse repetition interval, measurements shall be made with the pulse train gated on. Alternative measurement procedures may be considered by the Commission.

Part 15.521(h)

The highest frequency employed in § 15.33 to determine the frequency range over which radiated measurements are made shall be based on the center frequency, f_c , unless a higher frequency is generated within the UWB device. For measuring emission levels, the spectrum shall be investigated from the lowest frequency generated in the UWB transmitter, without going below 9 kHz, up to the frequency range shown in § 15.33(a) or up to $f_c + 3/(\text{pulse width in seconds})$, whichever is higher. There is no requirement to measure emissions beyond 40 GHz provided f_c is less than 10 GHz; beyond 100 GHz if f_c is at or above 10 GHz and below 30 GHz; or beyond 200 GHz if f_c is at or above 30 GHz.

RSS-220[5.3.1](d)

Radiated emissions above 960 MHz from a device shall not exceed the following average limits when measured using a resolution bandwidth of 1 MHz.

Hand-held (Outdoor) Communication, Measurement, Location Sensing, and Tracking Devices	
Frequency in MHz	EIRP in dBm
960 – 1 610	-75.3
1 610 – 4 750	-70.0
4 750 – 10 600	-41.3
Above 10 600	-61.3

RSS-220[5.3.1](e)

In addition to the limits specified in paragraph (d) of this section, radiated emissions shall not exceed the following average limits when measured using a resolution bandwidth greater than or equal to 1 kHz. The measurements shall demonstrate compliance with the stated limits at whatever resolution bandwidth is used.

Frequency in MHz	EIRP in dBm
1 164 - 1 240	-85.3
1 559 - 1 610	-85.3

■ Test Configuration

Refer to the APPENDIX I.

■ Test Procedure**ANSI C63.10-2013 Section 6.6**

- 1) These measurements were performed at 3 m test site.
- 2) The equipment under test is placed on a non-conductive table 1.5 meters above a turntable which is flush with the ground plane and 3 meters from the receive antenna.
- 3) For measurements above 1GHz absorbers are placed on the floor between the turn table and the antenna mast in such a way so as to maximize the reduction of reflections.
- 4) The antenna is a broadband antenna, and its height is varied from one meter to four meters above the ground to determine the maximum value of the field strength. Both horizontal and vertical polarizations of the antenna are set to make the measurement.
- 5) For each suspected emission, the EUT was arranged to its worst case and then the antenna was tuned to heights from 1 meter to 4 meters and the table was turned from 0 degrees to 360 degrees to find the maximum reading.

Instrument setting:

1. Set the RBW = 1 MHz
2. Set VBW \geq 1 MHz (a VBW of 3MHz is desirable)
3. Detector = RMS (power averaging)
4. Sweet time \leq Sweep point x 1 ms
5. Trace mode = max hold
6. Allow trace to fully stabilize

Unwanted emissions in 1 164 - 1 240MHz and 1 559 - 1 610MHz

1. Set the RBW = 1 kHz
2. Set VBW \geq 3 kHz
3. Detector = RMS (power averaging)
4. Sweet time \leq Sweep point x 1 ms
5. Trace mode = max hold
6. Allow trace to fully stabilize

■ **Test Results: Comply**

- Test Notes

1. The unwanted emissions were investigated up to 40 GHz. And no other spurious and harmonic emissions were found below listed frequencies.

2. Sample Calculation

$EIRP (dBm) = E (dB\mu V/m) + 20\log(D) - 104.7$; where D is the measurement distance in m.

$E(dBuV/m) = \text{Measured level (dBuV)} + TF(dB/m)$

where, E = field strength, TF = Total Factor, $TF = \text{Antenna Factor}(dB/m) + \text{Cable Loss}(dB) - \text{Amplifier Gain}(dB)$

3. # = Fundamental, * = Noise floor

Tested frequency: 6 489.6 MHz

Frequency (MHz)	ANT Pol	Measured Level(dBuV)	TF (dB/m)	E (dBuV/m)	Result (dBm)	FCC Limit(dBm)	FCC Margin(dB)	IC Limit(dBm)	IC Margin(dB)
*960.06	H	25.97	5.17	31.14	-79.58	-75.30	4.28	-75.30	4.28
*1 024.25	H	34.60	-5.18	29.42	-80.47	-75.30	5.17	-75.30	5.17
*3 117.25	H	32.51	0.79	33.30	-76.59	-41.30	35.29	-70.00	6.59
#6 420.04	H	43.92	8.52	52.44	-42.72	-41.30	1.42	-41.30	1.42
*12 131.75	H	32.20	10.44	42.64	-68.08	-61.30	6.78	-61.30	6.78
*16 243.25	H	35.81	10.37	46.18	-64.54	-61.30	3.24	-61.30	3.24
*38 708.25	H	38.95	3.64	42.59	-68.13	-61.30	6.83	-61.30	6.83

Unwanted emissions in 1 164 – 1 240MHz and 1 559 - 1 610MHz (RBW = 1 kHz)

Frequency (MHz)	ANT Pol	Measured Level(dBuV)	TF (dB/m)	E (dBuV/m)	Result (dBm)	FCC Limit(dBm)	FCC Margin(dB)	IC Limit(dBm)	IC Margin(dB)
*1 186.80	H	13.62	-3.02	10.60	-94.10	-85.30	8.80	-85.30	8.80
*1 574.64	H	12.40	-2.25	10.15	-94.55	-85.30	9.25	-85.30	9.25

Tested frequency: 7 987.2 MHz

Frequency (MHz)	ANT Pol	Measured Level(dBuV)	TF (dB/m)	E (dBuV/m)	Result (dBm)	FCC Limit(dBm)	FCC Margin(dB)	IC Limit(dBm)	IC Margin(dB)
*960.14	H	25.89	5.17	31.06	-79.66	-75.30	4.36	-75.30	4.36
*1 007.25	H	34.19	-5.22	28.97	-80.92	-75.30	5.62	-75.30	5.62
*3 116.75	H	32.32	0.81	33.13	-76.76	-41.30	35.46	-70.00	6.76
#8 064.97	H	42.86	9.66	52.52	-42.64	-41.30	1.34	-41.30	1.34
*12 148.25	H	32.24	10.46	42.70	-68.02	-61.30	6.72	-61.30	6.72
*16 243.75	H	35.78	10.37	46.15	-64.57	-61.30	3.27	-61.30	3.27
*38 701.25	H	38.98	3.64	42.62	-68.10	-61.30	6.80	-61.30	6.80

Unwanted emissions in 1 164 – 1 240MHz and 1 559 - 1 610MHz (RBW = 1 kHz)

Frequency (MHz)	ANT Pol	Measured Level(dBuV)	TF (dB/m)	E (dBuV/m)	Result (dBm)	FCC Limit(dBm)	FCC Margin(dB)	IC Limit(dBm)	IC Margin(dB)
*1 171.45	H	12.50	-3.27	9.23	-95.47	-85.30	10.17	-85.30	10.17
*1 590.94	H	12.98	-2.27	10.71	-93.99	-85.30	8.69	-85.30	8.69

Worst case plot(Measured Level)

7 987.2 MHz & X axis & Hor

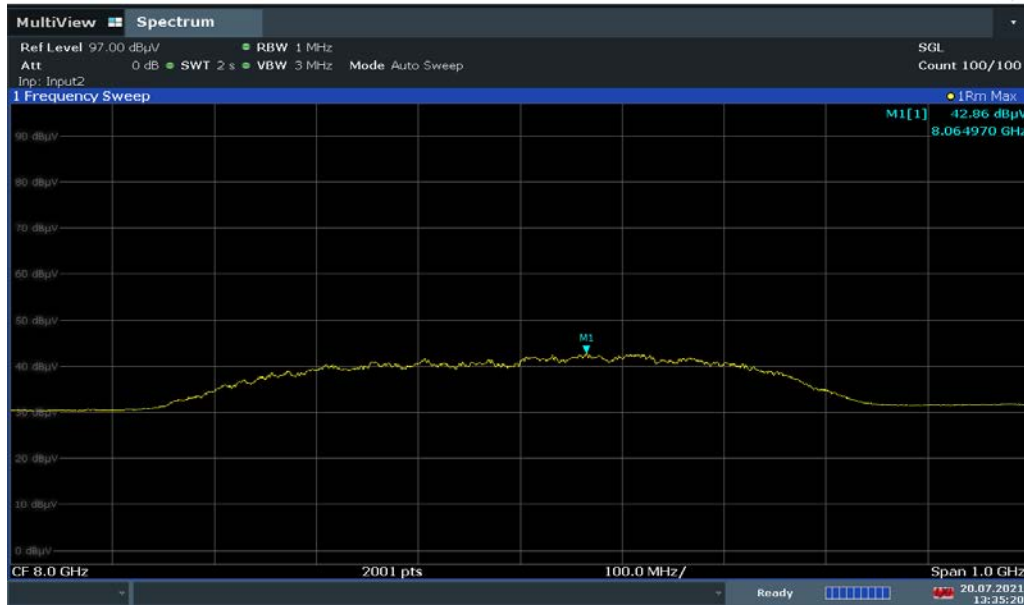

Plot(Measured Level)
(1 164 - 1 240, 1 559-1 610 MHz)

7 987.2 MHz & X axis & Hor

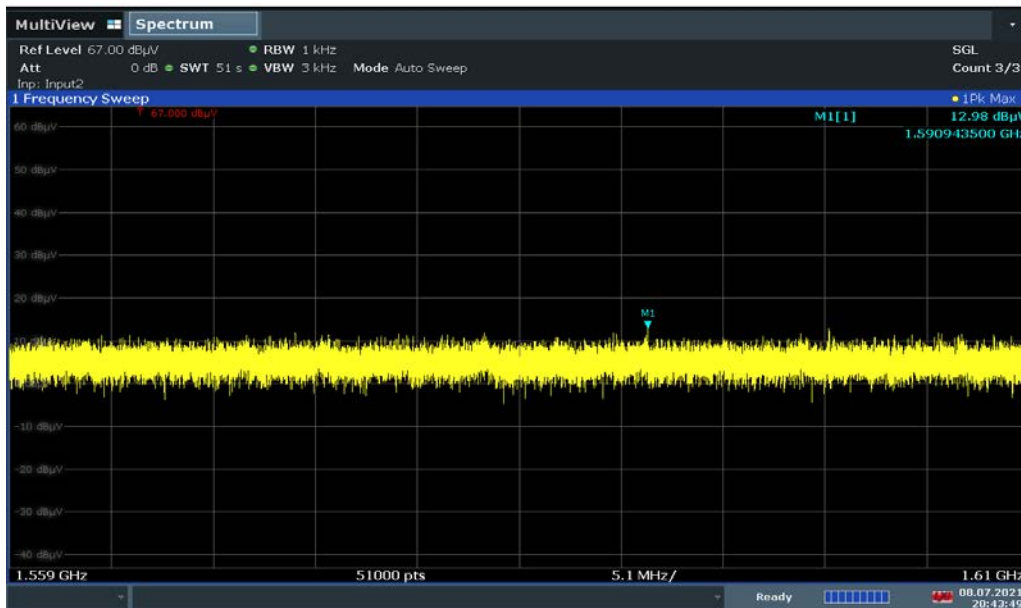

5.4. AC Power-Line Conducted Emissions

■ Test Requirements and limit

Part 15.207 & RSS-Gen[8.8]

An intentional radiator that is designed to be connected to the public utility (AC) power line, the radio frequency voltage that is conducted back onto the AC power line on any frequency or frequencies, within the band 150 kHz to 30 MHz, shall not exceed the limits in the following table, as measured using a 50 uH/50 ohm line impedance stabilization network (LISN).

Compliance with the provision of this paragraph shall on the measurement of the radio frequency voltage between each power line and ground at the power terminal. The lower applies at the boundary between the frequency ranges.

Frequency Range (MHz)	Conducted Limit (dBuV)	
	Quasi-Peak	Average
0.15 ~ 0.5	66 to 56 *	56 to 46 *
0.5 ~ 5.0	56	46
5 ~ 30	60	50

* Decreases with the logarithm of the frequency

Part 15.521(j)

Responsible parties are reminded of the other standards and requirements cross referenced in § 15.505, such as a limit on emissions conducted onto the AC power lines.

■ Test Configuration

NA

■ Test Procedures

Conducted emissions from the EUT were measured according to the ANSI C63.10-2013.

1. The test procedure is performed in a 6.5 m × 3.5 m × 3.5 m (L × W × H) shielded room. The EUT along with its peripherals were placed on a 1.0 m (W) × 1.5 m (L) and 0.8 m in height wooden table and the EUT was adjusted to maintain a 0.4 meter space from a vertical reference plane.
2. The EUT was connected to power mains through a line impedance stabilization network (LISN) which provides 50 ohm coupling impedance for measuring instrument and the chassis ground was bounded to the horizontal ground plane of shielded room.
3. All peripherals were connected to the second LISN and the chassis ground also bounded to the horizontal ground plane of shielded room.
4. The excess power cable between the EUT and the LISN was bundled. The power cables of peripherals were unbundled. All connecting cables of EUT and peripherals were moved to find the maximum emission.

■ Test Results

NA

5.5. Cease Transmission Time

■ Test Requirements and limit

Part 15.519(a)(1)

A UWB device operating under the provisions of this section shall transmit only when it is sending information to an associated receiver. The UWB intentional radiator shall cease transmission within 10 seconds unless it receives an acknowledgement from the associated receiver that its transmission is being received. An acknowledgment of reception must continue to be received by the UWB intentional radiator at least every 10 seconds or the UWB device must cease transmitting.

RSS-Gen[5.3.1](b)

The device is to transmit only when it is sending information to an associated receiver. The device shall cease transmission of information within 10 seconds unless it receives an acknowledgement from the associated receiver that its transmission is being received. An acknowledgment of reception must continue to be received by the UWB device at least every 10 seconds or the UWB device shall cease transmitting any information other than periodic signals used for the establishment or re-establishment of a communication link with an associated receiver.

■ Test Configuration

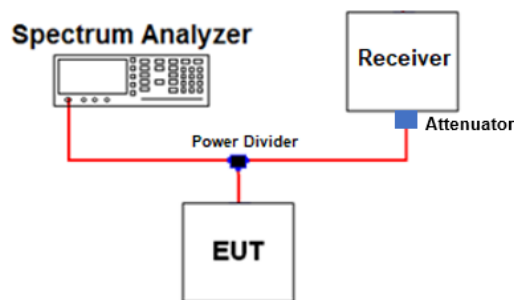

■ Test Procedures

EUT and receiving pairing device keep UWB normal connection.

The receiver device ends the UWB link during normal operation and observe that the EUT cease transmission within 10 seconds.

Test Results: Comply

Tested Frequency(MHz): 6 489.6

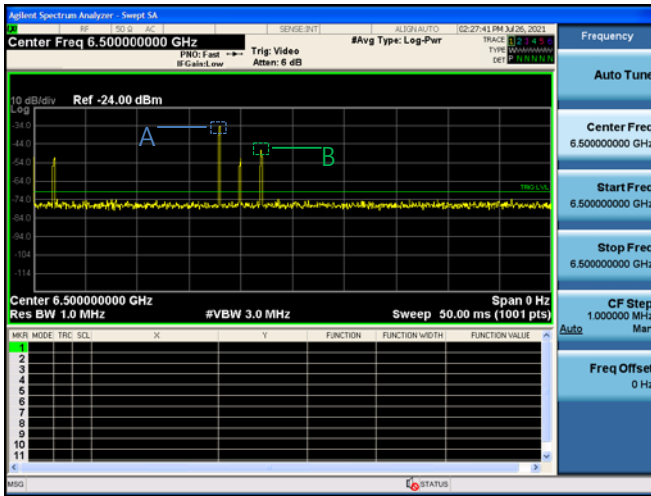

A: EUT transmission signal
B: Receiver signal



C: The receiver device ends the UWB link.
D: The EUT cease transmission within 10 seconds.

5.6. Occupied Bandwidth

■ Test Requirements and limit

RSS-Gen[6.7]

The occupied bandwidth or the “99% emission bandwidth” is defined as the frequency range between two points, one above and the other below the carrier frequency, within which 99% of the total transmitted power of the fundamental transmitted emission is contained. The occupied bandwidth shall be reported for all equipment in addition to the specified bandwidth required in the applicable RSSs.

■ Test Configuration

Refer to the APPENDIX I.

■ Test Procedures

- The transmitter shall be operated at its maximum carrier power measured under normal test conditions.
- The span of the spectrum analyzer shall be set large enough to capture all products of the modulation process, including the emission skirts, around the carrier frequency, but small enough to avoid having other emissions (e.g. on adjacent channels) within the span.
- The detector of the spectrum analyzer shall be set to “Sample”. However, a peak, or peak hold, may be used in place of the sampling detector since this usually produces a wider bandwidth than the actual bandwidth (worst-case measurement). Use of a peak hold (or “Max Hold”) may be necessary to determine the occupied / x dB bandwidth if the device is not transmitting continuously.
- The resolution bandwidth (RBW) shall be in the range of 1% to 5% of the actual occupied / x dB bandwidth and the video bandwidth (VBW) shall not be smaller than three times the RBW value. Video averaging is not permitted.

Note: It may be necessary to repeat the measurement a few times until the RBW and VBW are in compliance with the above requirement.

Test Results: **Comply**

Tested Frequency (MHz)	Occupied Bandwidth(MHz)
6 489.6	621.64
7 987.2	626.84

Occupied Bandwidth

Tested Frequency(MHz): 6 489.6

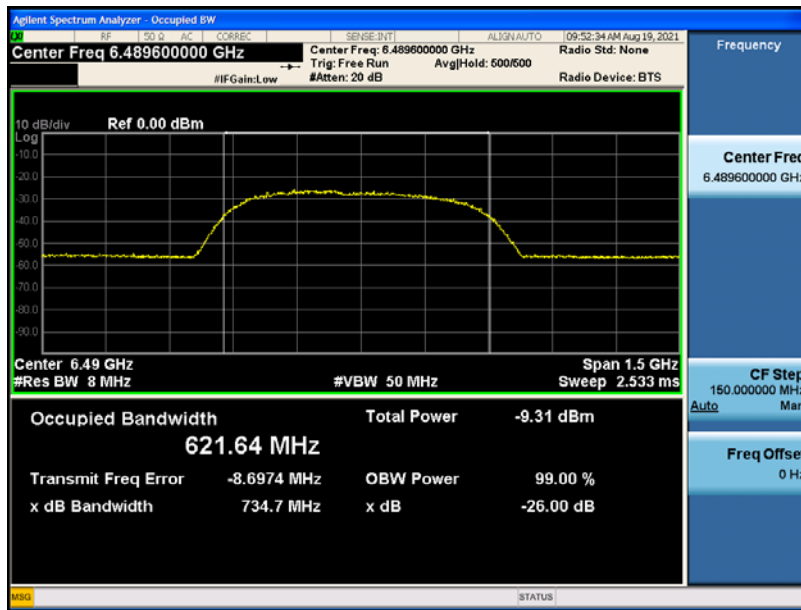

Occupied Bandwidth

Tested Frequency(MHz): 7 987.2

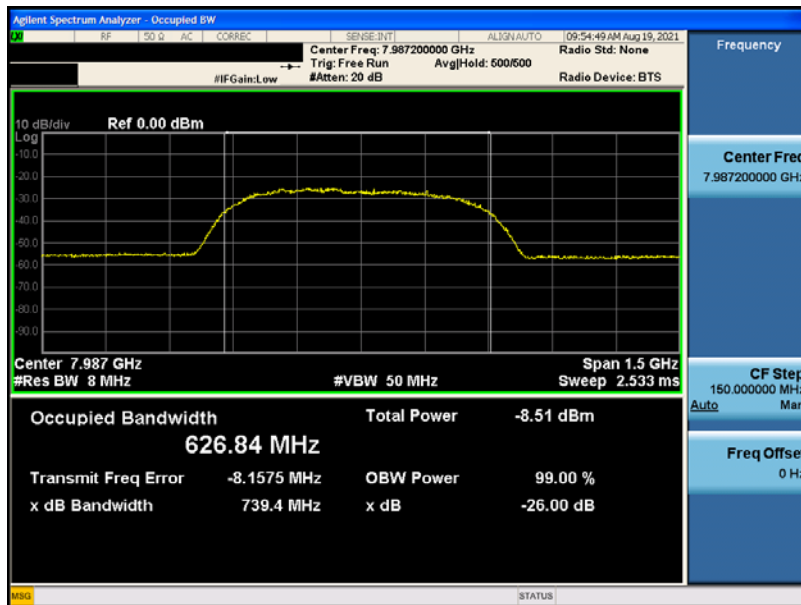

APPENDIX I

Test set up diagrams

▪ Radiated Measurement

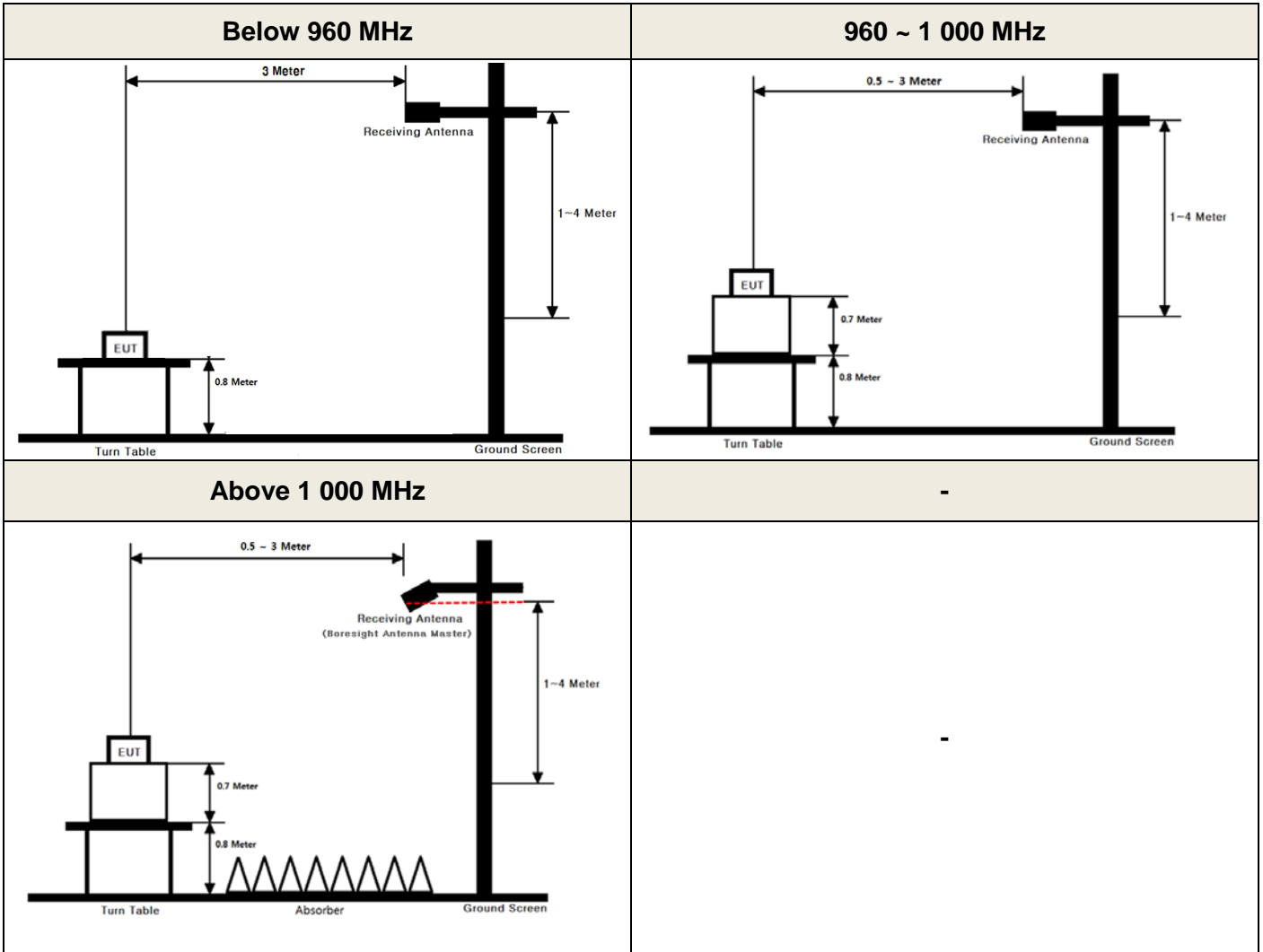

▪ Conducted Measurement

