

---

# Quick Installation Guide

---

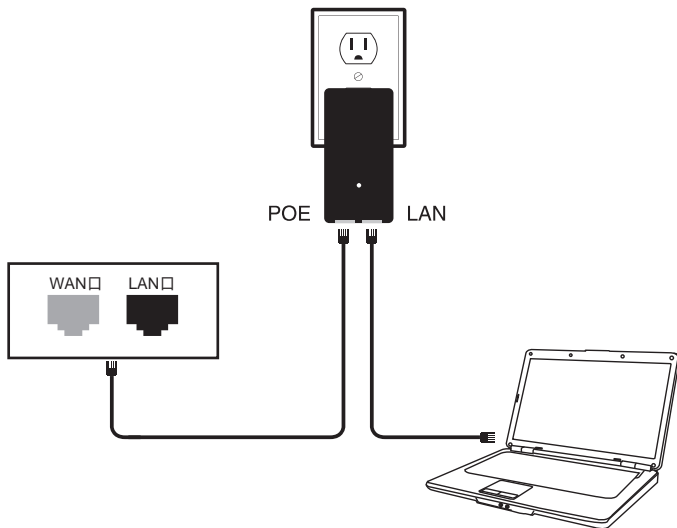

Power LAN port .....→ connect with a PC or a router

Power POE port .....→ connect device LAN port (supply power to the device)

NOTE : Use LAN ports of the device to log in software

1 Open your "Network Connections"

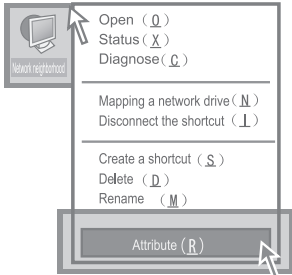

2 Open your "Local Area Connections", and choose "Property" .

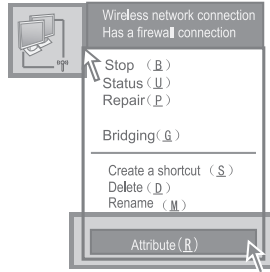

3 Double click "Internet Protocol (TCP/IP) Properties".

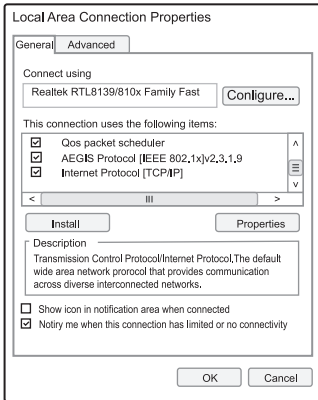

4 Set your IP to "Use the following IP address"

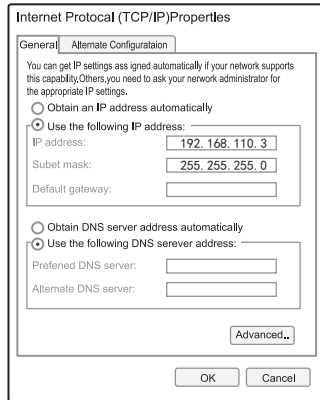

5 Open your IE and enter in "192.168.110.1", the password is "password" enter in the password "password"

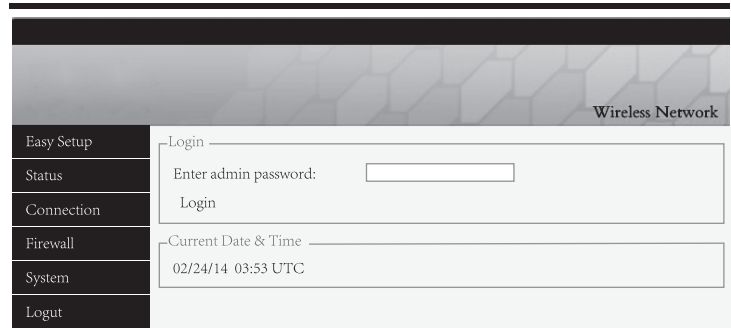

6 Get into the firmware.and choose "Easy Setup" (choose the Mode which you need)

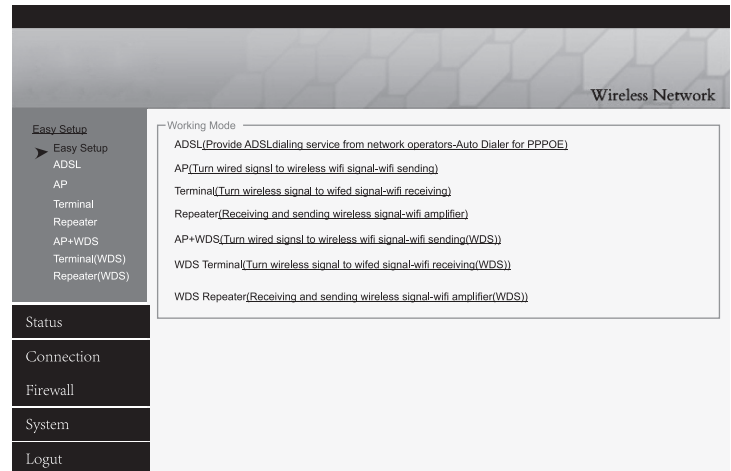

## ADSL Mode (dialing)

Choose "ADSL", enter the user name and password of your broadband, and set your own SSID, and set your ip to 192.168.110.1, and save changes. (PS: the cable need be connected with WAN port in ADSL Mode)

Internet / WAN

User Name:  ← enter the user name

Password:  ← enter the password

Reconnect Mode:  (seconds)

Local Network / LAN

Router IP:  ← Set your IP

Local Network / LAN

Operation Mode:

Channel Width:

Transmit Power:   (0-27dBm)

Wireless MAC Filter:  ← Default bandwidth

Access Point SSID:  ← your wifi name

Wireless Channel:  ← support 1-11 channels

Encryption:  ← Choose WPA PSK, and set your password

Password:

Save Changes Reset

## Steps of Setting up (refer to the left picture)

1. Write down ADSL and password
2. Set up IP address of Router (for example: 192.168.110.1)
3. Frequency setting (support 2.3-2.7G)

Note: in general, routers, mobile phone, laptop only could receive 2.4Ghz channel

(1) Firstly, choose "width of broadband"

40MHz (2nd chan. below) ▼

40MHz (2nd chan. above) ▼

(2) Secondly, choose the channel which you need in "wireless channel"

4. Write down the name of SSID (like: wifi, do not support Chinese SSID)
5. Choose encryption (like: choose WPA PSK, add wifi password)
6. Save and finish setting.

## Environment setting

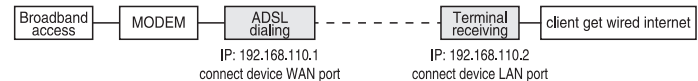

## AP Mode (sending)+WDS

Choose "AP", enter the user name and password of wifi, set your ip to 192.168.110.1, and save changes. (PS:the cable need be connected with LAN port in AP Mode)

### Steps of Setting up (refer to the left picture)

1. Write down ADSL and password
2. Set up IP address of Router (for example : 192.168.110.1)
3. Frequency setting  
Note : in general , routers , mobile phone , laptop only could receive 2.4Ghz channel  
( 1 ) Firstly , choose " width of broadband "  
40MHz (2nd chan. below) 40MHz (2nd chan. above)  
( 2 ) Secondly choose the channel which you need in " wireless channel "
4. Write down the name of SSID ( like : wifi , do not support Chinese SSID )
5. Choose encryption ( like : choose WPA PSK , add wifi password )
6. Save changes , Select " Status " to cancel " DHCP Services " ( picture above )
7. Save and finish setting.

### Environment setting

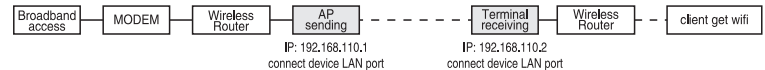

## Terminal Mode+WDS

Choose "Terminal", scan wifi name and enter in the password, and set your ip to 192.168.110.2, and save changes. (PS: the cable need be connected with LAN port in Terminal Mode)

The screenshot shows the 'Wireless Network' configuration page. On the left is a navigation menu with options: Easy Setup, ADSL, AP, Terminal, Repeater, AP+WDS, and Terminal(WDS) Repeater(WDS). The main area is titled 'Wireless Bridge/Repeater' and contains the following fields:

- Bridge IP : 192.168.110.2 (must be in AP subnet)
- Subnet Mask : 255.255.255.0 (same as AP mask)
- AP/Gateway IP : 192.168.110.1 ← Enter in IP
- Wan Ethernet Port : Disable
- DNS Servers : Use Gateway As DNS Server
- Connect Via WDS : [Dropdown]
- Operation Mode : N+A
- Channel Width : 40MHz (2nd chan. below) ← Default bandwidth
- Transmit Power : Max 27 (0-27dbm)
- SSID to Join : WIFI Scan ← Scan wifi
- MAC Binding ( Blank if not binding ) : [Blank]
- Wireless Channel : 2452MHz[11]
- Encryption : None

At the bottom are 'Save Changes' and 'Reset' buttons.

## Steps of Setting up (refer to the left picture)

- 1.Change WAN port into LAN port according to demand
- 2.Set up IP address of Router (for example:192.168.110.1)
- 3.Setting SSID, scan the available wifi signal
- 4.Write down the name of SSID (like: wifi, do not support Chinese SSID)
- 5.Choose encryption (like: choose WPA PSK, add wifi password)
- 6.Save and finish setting.

## Environment setting

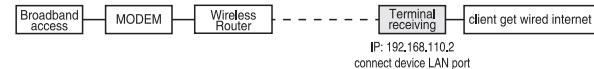

## Note:

- 1.if the strength of signal light on, could connect QQ but could not open the website, Pls choose "connection" option at the left, DNS change to "Google DNS serve" .
- 2.when receiving CMCC, DNS change to "Operators provide default DNS serve" .

## Repeater Mode

Choose "Repeater", scan wifi name and enter in the password, and set your ip to 192.168.110.3, and save changes. (PS: the cable need be connected with LAN port in Repeater Mode)

Wireless Network

Easy Setup

Easy Setup

ADSL

AP

Terminal

▶ Repeater

AP+WDS

Terminal(WDS)

Repeater(WDS)

---

Current IP :

Current Lease Expires :

Wan Ethernet Port :

---

Local Network / LAN

Router IP:  ← Set your IP

---

Wireless

Channel Width:  ← Default bandwidth

Transmit Power:

Wireless MAC Filter:

---

SSID to Join:

MAC Binding(Blank if not binding):

Wireless Channel:

Encryption:

---

Access Point SSID:  ← your wifi name

Wireless Channel:  ← support 1–11 channels

Encryption:  ← Choose WPA PSK, and set your password

Clients Quantity:

← Scan wifi

### Setting setup (Reference the left picture):

- 1.Setting the router IP address : (For example:192.168.110.3)
- 2.Setting SSID, scan the available wifi signal
- 3.Enter the name of SSID wifi signal(For example: wifi )
- 4.Choose the encryption(For example: WPA PSK, add wifi password)
- 5.Save the change , set up is finished

### Environment setting

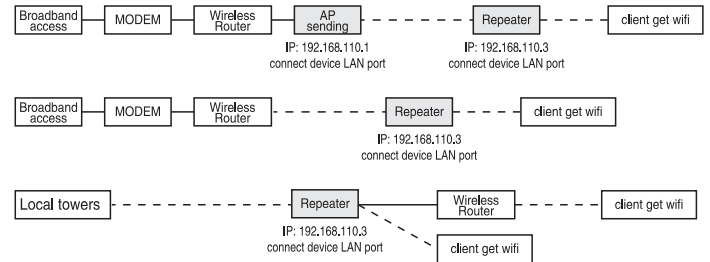

### Note:

- 1.If the device signal indicator light is on, and its can connect to QQbut can't open the website,Please click the left selection “connect” , DNS change to “Google DNS servicer ”
- 2.When receiving CMCC, DNS should change to “Operators of DNS server by default”

### Q&A

Q1 How dose CPE get the power without power supply?

We use POE power,CPE get the power via cable.User need use 2 cables to connect and setting(better use Super five types copper cable with shielding net)POE manual can refer to cover connecting picture,but please remember connect with LAN port(black port),not the yellow one.

Q2 How long the POE cable can be?

The length of cable depends on power voltage and cable quality.If you use 12v power, cable can be 10–20m.If you use 24v power,cable can be over 20m Cable must be Super five types copper cable with shielding net(Better quality can be 50m)

Q3 How to reset CPE?

Get device power on, long press RESET button (7-10), device reboot.

Q4 How to solve the LAN can't get the IP address even the cable connect to the computer?

The cable must connect to the wireless bridge LAN port, if connect to WAN then will not get the IP address.

Q5 Why local Area Connection is on and off after installed device?

Detection method as below:

1. Try to change 1m cable, make sure it is not quality of cable problem.
2. Try to change channels, avoid signal quality problem cause disturbance.

Q6 Why the website blank and show the mistake that can't enter password?

You can try to change the IE version, recommend the Google browser.

Q7 What's the mean of repeater?

Repeater means when receive the signal, it will transfer the signal meanwhile output the wireless signal. As the function of the amplifier.

Q8. Light of signal

Red: PWR: power light showing the normal working status.

Blue: WLAN: wifi signal light the strobe light show the normal working status.

WAN, LAN: LAN light showing the normal working status.

Orange: 1-4 Signal Strength Indicator

Light 1, The signal is too weak.

Light 1.2, The signal is weak.

Light 1.2.3, The signal is general.

Light 4, The signal is too strong.

Light 1.2.3.4, The best signal.

### FCC Warning:

This equipment has been tested and found to comply with the limits for a Class B digital device, pursuant to part 15 of the FCC Rules. These limits are designed to provide reasonable protection against harmful interference in a residential installation. This equipment generates, uses and can radiate radio frequency energy and, if not installed and used in accordance with the instructions, may cause harmful interference to radio communications. However, there is no guarantee that interference will not occur in a particular installation. If this equipment does cause harmful interference to radio or television reception, which can be determined by turning the equipment off and on, the user is encouraged to try to correct the interference by one or more of the following measures:

- Reorient or relocate the receiving antenna.
- Increase the separation between the equipment and receiver.
- Connect the equipment into an outlet on a circuit different from that to which the receiver is connected.
- Consult the dealer or an experienced radio/TV technician for help.

Caution: Any changes or modifications to this device not explicitly approved by manufacturer could void your authority to operate this equipment.

This device complies with part 15 of the FCC Rules. Operation is subject to the following two conditions: (1) This device may not cause harmful interference, and (2) this device must accept any interference received, including interference that may cause undesired operation.

This equipment complies with FCC radiation exposure limits set forth for an uncontrolled environment. This equipment should be installed and operated with minimum distance 20cm between the radiator & your body.