

成品尺寸：90*120mm

材质：108g铜版纸

要求：黑白印刷，

工艺：按顺序做骑马钉

料号：416-0D39C091-HBa9R

ULTIMEA

USER MANUAL

TAPIO V

2.1 CH Soundbar System

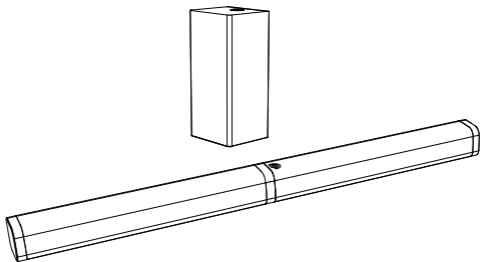

BEDIENUNGSANLEITUNG | MANUEL D'UTILIZATION | MANUAL DEL USUARIO

MANUALE UTENTE | 取扱説明書

www.Ultimea.com

Thank you for purchasing Ultimea Tapio V. This guide will help you set up so you can enjoy the ultimate sound experience.

IN THE BOX



DIAGRAM (BUTTONS, PORTS & INDICATOR)

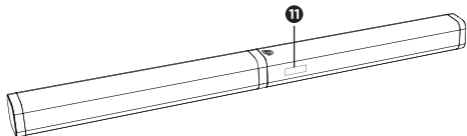
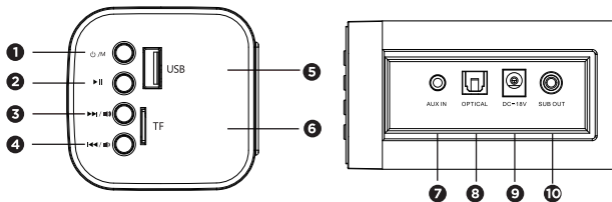

- EN:**
- | | | | | |
|----|---|----|-------------------------|--|
| 1 | Power on/off / Mode | 2 | Play / Pause | |
| 3 | Next Song / Volume+ | 4 | Previous Song / Volume- | |
| 5 | USB Input | 6 | TF Card Input | |
| 7 | AUX Input | 8 | Optical Input | |
| 9 | DC 18V IN Jack | 10 | SUB OUT Jack | |
| 11 | LED Indicator: Bluetooth Mode: bt 、Optical Input: OPT 、Aux Input: AUX 、USB Input: USB . | | | |

- DE:**
- | | | | | |
|----|---|----|--------------------------------------|--|
| 1 | Ein-und Ausschalten/Modus | 2 | Spielen / Pause | |
| 3 | Nächstes Lied / Lautstärke erhöhen | 4 | Letztes Lied / Lautstärke verringern | |
| 5 | USB-Anschluss | 6 | TF Karte- Anschluss | |
| 7 | AUX-Anschluss | 8 | Optisch-Anschluss | |
| 9 | DC 18V IN Steckdose | 10 | SUB OUT Steckdose | |
| 11 | LED-Anzeiger: Bluetooth-Modus: bt 、Optisch-Modus: OPT 、Aux-Modus: AUX 、USB-Modus: USB . | | | |

- FR:**
- | | | | | |
|----|---|----|---|--|
| 1 | Interrupteur / Mode | 2 | Jouer / Pause | |
| 3 | Chanson Suivante / Augmenter le Volume | 4 | Chanson Précédente / Diminuer le Volume | |
| 5 | Entrée USB | 6 | Carte TF | |
| 7 | Entrée AUX | 8 | Entrée Optique | |
| 9 | Prise DC 18V IN | 10 | Prise SUB OUT | |
| 11 | Indicateur LED: Mode Bluetooth: bt 、Entrée Optique: OPT 、Entrée AUX: AUX 、Entrée USB: USB . | | | |

- ES:**
- | | |
|--|-----------------------------------|
| ❶ interruptor / Modo | ❷ Reproduce / Pausa |
| ❸ Canción siguiente / Sube volumen | ❹ Canción anterior / Baja volumen |
| ❺ Entrada de USB | ❻ Entrada de Tarjeta TF |
| ❽ Entrada de AUX | ❼ Entrada Optica |
| ❾ DC 18V IN Jack | ❿ SUB OUT Jack |
| ❶❶ LED Indicador: Modo de Bluetooth: b♯ 、Entrada Optica: OP♯ 、
Entrada de AUX: AUX 、Entrada de USB: USB . | |

- IT:**
- | | |
|--|----------------------------|
| ❶ Interruttore / Modalità | ❷ Play / Pausa |
| ❸ Brano successivo/Volume+ | ❹ Brano precedente/Volume- |
| ❺ Ingresso USB | ❻ Ingresso TF Card |
| ❽ Ingresso AUX | ❼ Ingresso Ottico |
| ❾ DC 18V IN Jack | ❿ SUB OUT Jack |
| ❶❶ Indicatore LED:Modalità Bluetooth: b♯ 、Ingresso Ottico: OP♯ 、
Ingresso AUX: AUX 、Ingresso USB: USB . | |

- JP:**
- | | |
|---|------------------|
| ❶ スイッチオン・オフ/モード | ❷ 再生/一時停止 |
| ❸ 次の楽曲/ボリュームを上げる | ❹ 前の楽曲/ボリュームを下げる |
| ❺ USBポート | ❻ TFカードスロット |
| ❽ AUX入力 | ❼ 光ケーブル入力 |
| ❾ 18V DC電源入力端子 | ❿ サブウーファー接続端子 |
| ❶❶ LEDインジケータ：ブルーーツースモード： b♯ 光ケーブル入力： OP♯
Aux入力： AUX USB入力： USB . | |

REMOTE CONTROL

Battery installation

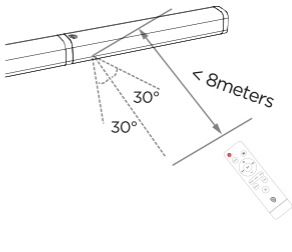
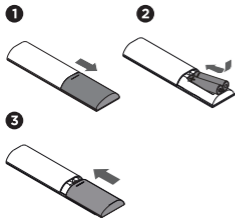

EN:

Use remote control

The working range of remote is $\pm 30^\circ$ in both Vertical and Horizontal Direction.

FR:

Utiliser la télécommande

Horizontal et vertical, la portée effective de la télécommande est de ± 30 .

IT:

Usare il telecomando

Il campo di lavoro del telecomando è $\pm 30^\circ$ in entrambe le direzioni verticale e orizzontale.

DE:

Die Benutzung von der Fernbedienung

Der Arbeitsbereich der Fernbedienung beträgt sowohl in vertikaler als auch in horizontaler Richtung $\pm 30^\circ$.

ES:

Utilice el control remoto

El rango efectivo del control remoto es de ± 30 en dirección tanto vertical como horizontal.

JP:

リモコンの使用

水平方向と垂直方向、リモコンの有効範囲は ± 30 です。

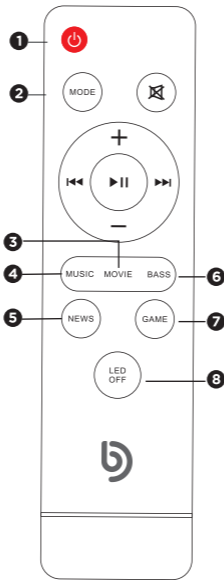

- EN: **1** **【Power】** : Short press for 1s to power on, Hold and press for 3s to power off
- 2** **【MODE】** : Short press the button to switch input modes among Bluetooth, Optical, Aux, USB and TF Card
- 3** **【MOVIE】** : For movies
- 4** **【MUSIC】** : For music
- 5** **【NEWS】** : For talk show, interview, news etc to hear dialogues clearly
- 6** **【BASS】** : For movies and music with strong bass
- 7** **【GAME】** : For playing and watching game
- 8** **【LED OFF】** Hold the button to turn on/off LED indicator on soundbar

- DE: 1 **【🔌】** : Zum Einschalten kurz 1S drücken, zum Ausschalten lange 5S drücken
- 2 **【MODE】** : Kurz drücken, um die Modie zu wechseln (Modie: Bluetooth, Optisch, Aux, USB and TF Karte)
- 3 **【MOVIE】** : Film-Modus, das dafür geeignet ist, Film zu schauen
- 4 **【MUSIC】** : Musik-Modus, das dafür geeignet ist, Musik zu hören
- 5 **【NEWS】** : Nachrichten-Modus, das dafür geeignet ist, Talkshows, Interviews, Nachrichtensendungen usw. zu schauen
- 6 **【BASS】** : Bass-Modus, das dafür geeignet ist, Filme und Musik mit stärkerem Bass zu hören
- 7 **【GAME】** : Spiel-Modus, das dafür geeignet ist, spielen und Spielvideo zu schauen
- 8 **【LED OFF】** Lange drücken, um die Anzeige der Soundbar ein- und auszuschalten

- FR: 1 **【🔌】** : Appuyez brièvement sur 1s pour allumer, appuyez longuement sur 3s pour éteindre
- 2 **【MODE】** : Mode de commutation (Bluetooth, Optique, Aux, USB et Carte TF)
- 3 **【MOVIE】** : Mode Cinématographique, adapté pour regarder des films
- 4 **【MUSIC】** : Mode Musique, adapté pour profiter de la musique
- 5 **【NEWS】** : Mode News, adapté pour écouter des talk-shows, des interviews, des programmes d'information, etc.
- 6 **【BASS】** : Mode Subwoofer, adapté pour écouter de la musique de basse lourde
- 7 **【GAME】** : Mode Jeu, adapté pour jouer à des jeux vidéo
- 8 **【LED OFF】** Appuyez longuement pour activer / désactiver l'indicateur LED

- ES: 1 **【🔌】** : Púlsalo brevemente por 1 segundo para encenderlo, y pulsa por 3 segundos para apagarlo
- 2 **【MODE】** : Púlsalo brevemente para cambiar modos (Bluetooth, Optico, Aux, USB y Tarjeta TF)
- 3 **【MOVIE】** : Modo de Cine, adecuado para películas
- 4 **【MUSIC】** : Modo de Música, adecuado para música
- 5 **【NEWS】** : Modo de Noticia, apto para talkshow, entrevista, noticias etc.
- 6 **【BASS】** : Modo de Bass, adecuado para películas y música con bajos fuertes

- 7 **【GAME】** : Modo de Juegos, adecuado para hacer juegos o ver videos de juegos
- 8 **【LED OFF】** Púlsalo largamente para apagar / encender el indicador de la barra de sonido

- IT:
- 1 **【】** : Premere brevemente 1S per accendere, premere a lungo 3S per spegnere
 - 2 **【MODE】** : Premere brevemente per cambiare modalità (Bluetooth, Ottico, Aux, USB and TF Card)
 - 3 **【MOVIE】** : modalità filmato, per guardare i film
 - 4 **【MUSIC】** : modalità musica, per ascoltare la musica
 - 5 **【NEWS】** : Modalità notizie, per ascoltare talk show, interviste, notiziari, ecc.
 - 6 **【BASS】** : Modalità subwoofer, adatta per l'ascolto di film e musica con bassi più pesanti
 - 7 **【GAME】** : Modalità di gioco, adatta per giocare e guardare video di gioco
 - 8 **【LED OFF】** Premere a lungo per accendere / spegnere l'indicatore Soundbar

- JP:
- 1 **【】** : 1秒押しして機械をオンにして、3秒程押しすと機械をオフに
 - 2 **【MODE】** : 押し度にモードが変更されます。(Bluetooth、光ケーブル、Aux、USBやTFカード)
 - 3 **【MOVIE】** : 映画モード、映画を見るに合う
 - 4 **【MUSIC】** : 音楽モード、音楽を聞くに合う
 - 5 **【NEWS】** : 新聞モード、适合脱口秀、访谈、新闻节目等ニュースモード、トークショー、インタビュー、ニュース番組に合う
 - 6 **【BASS】** : 重低音モード、低音の強い音楽やゲームに合う
 - 7 **【GAME】** : ゲームモード、ゲームやゲームビデオを見るに合う
 - 8 **【LED OFF】** : 長押しするとサウンドバーのインジケータをオン/オフできる

USE YOUR SOUNDBAR SYSTEM PREPARE FOR USE

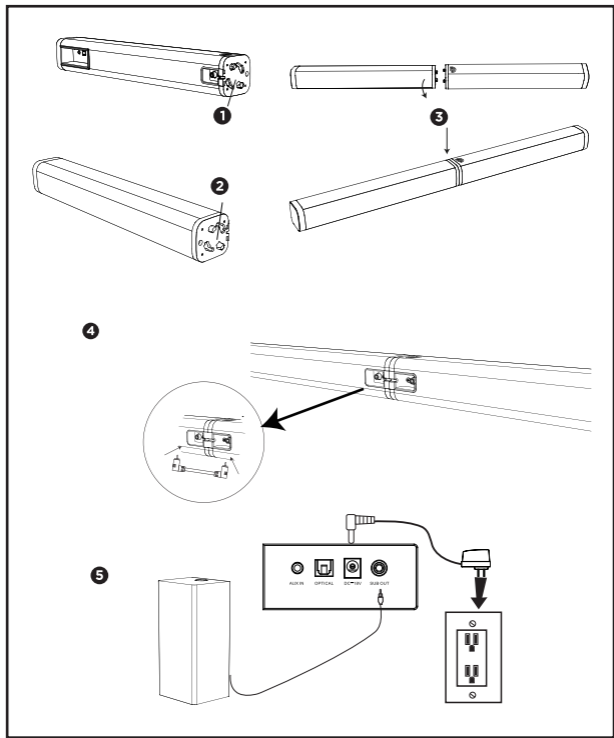

PLACEMENT

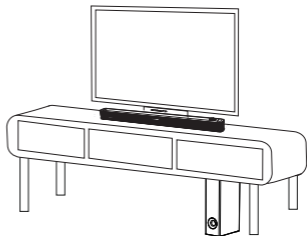

EN:

Placement

Table placement

Place the soundbar on a solid surface.

DE:

Platzierung

Tabellenplatzierung

Platzieren Sie die Soundbar auf einer festen Oberfläche.

FR:

Placement

Placement de la table

Placez la barre de son sur une surface solide.

ES:

Colocación

Colocación sobre la mesa

Coloque la barra de sonido en una superficie sólida.

IT:

Posizionamento

Posizionamento della tabella

Posiziona la soundbar su una superficie solida.

JP:

置く方法

机の上に置く

サウンドバーを固体表面に置く。

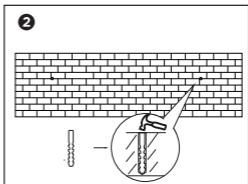
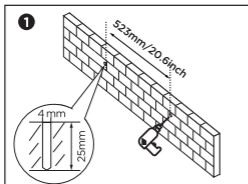

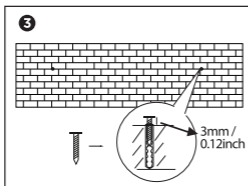

EN: Wall Mounting Installation

FR: Installation Murale

IT: Installazione A Parete

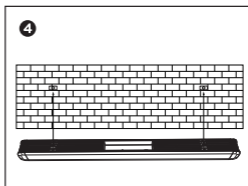

DE: Wandmontage Installation

ES: Instalación En La Pared

JP: 壁に取り付ける

A.Connect to your TV

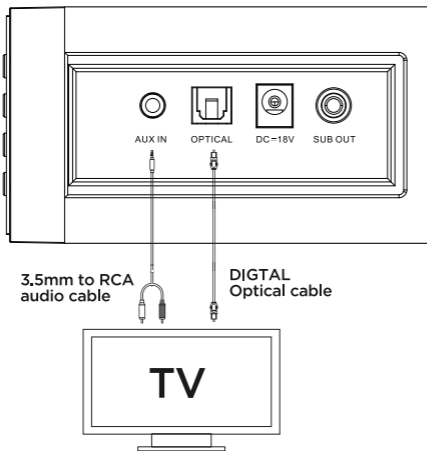

EN: Use Remote Control or Side Buttons of Sound bar to change modes.

Note:

1. Please make sure to change the TV audio output to External speaker.
2. Please make sure to select the Audio Output Format to PCM
3. 32 is the maximum volume of the Soundbar.

DE: Verwenden Sie die Fernbedienung oder die Tasten auf der Lautsprecher, um die Modie zu wechseln.

Hinweis:

1. Stellen Sie sicher, dass Sie die Tonausgabe des Fernsehgerätes für externe Lautsprecher auswählen.
2. Stellen Sie sicher, dass Audio Ausgang Modus zu PCM gewählt wird.
3. 32 ist die maximale Lautstärkeebene der Soundbar.

FR: Utiliser la télécommande ou les boutons de la barre de son pour commuter de mode.

Remarque:

1. Assurer de sélectionner des haut-parleurs externes pour la sortie audio du téléviseur.
2. Assurer de sélectionner PCM pour le format de sortie audio.
3. Le volume maximum de la barre de son est de 32.

ES: Puede cambiar modos por el mando a distancia o los botones laterales de la barra de sonido.

Nota:

1. Asegura que el ajuste de salida de audio de la tele ya es de altavoz exterior.
2. Asegura que el formato de salida de audio es PCM.
3. El volumen máximo de la barra de sonido es 32.

IT: Utilizzare il telecomando o i pulsanti laterali della barra audio per cambiare modalità.

Nota:

1. Assicurarsi di selezionare l'uscita audio del televisore su altoparlanti esterni.
2. Assicurati di selezionare PCM per Audio Output Format.
3. è il volume massimo della soundbar.

JP: モードを変更するには、リモートコントロールまたはサウンドバーのサイドボタンを使用します。

ご注意:

1. テレビのサウンド出力を外部スピーカーに選択してください。
2. オーディオ出力フォーマットにはPCMを選択してください。
3. サウンドバーの最大出力音量は32です。

B. Connect to other devices

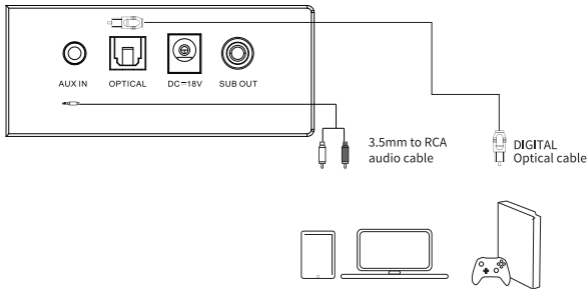

EN: Need to purchase one 3.5mm Audio Cable if your tv has 1 male audio output, the included RCA cable is 1 male to 2 male, will not fit.

FR: Si le périphérique connecté ne dispose que d'une sortie audio de 3,5 mm, configurez vous-même le câble audio approprié. Le câble RCA ne convient pas.

DE: Wenn das angeschlossene Gerät nur einen 3,5-mm-Audioausgang besitzt, konfigurieren Sie bitte das entsprechende Audiokabel selbst. Das RCA-Kabel in der Verpackung ist nicht geeignet.

ES: No incluye el cable RCA, debe comprar un cable de audio de 3.5 mm si su televisor solo tiene una salida de audio. El volumen tienen 32 niveles.

IT: È necessario acquistare un cavo audio da 3,5 mm se il televisore ha SOLO un'uscita audio da 3,5mm , il cavo RCA(Dobbio) incluso non si adatta.

JP: 3.5 mmオーディオケーブルは付属されていません。設備に3.5 mmオーディオ出力ポートが1つしかない場合は、自分で適切なオーディオラインをご用意ください。付属されたRCAケーブルは対応されていないことをご注意ください

C. Bluetooth mode

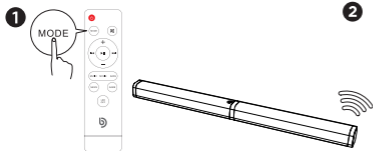

EN: To enter into Bluetooth Mode, use remote or side buttons on the soundbar, it shows flashing "Blue" light when connected.

FR: A l'étape 2, vous pouvez passer en mode Bluetooth via le bouton "BT" de la télécommande ou le bouton MODE de la barre de son. Le voyant de signalisation BT est bleu clignotant.

IT: Al fine di accedere alla modalità Bluetooth, utilizzare i pulsanti remoti o laterali sulla soundbar, mostra una luce blu "lampeggiante" quando è collegato.

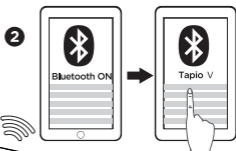

DE: Sie können in den Bluetooth-Modus wechseln, indem Sie die Taste "BT" auf der Fernbedienung oder die Taste "MODE" auf der Soundbar drücken, dann wird BT-Signal blinkt blau.

ES: En el paso 2, puede cambiar al modo Bluetooth mediante el botón "BT" en el control remoto o el botón MODE en la barra de sonido. La luz de señal de BT parpadeará en azul.

JP: ステップ2では、リモコンの「BT」ボタンまたはサウンドバーのMODEボタンでbluetoothモードに切り替えることができます。この時に、青のBTラントは点滅します。

SPECIFICATION:

Peak Power: 100W

Bluetooth Version: V5.0

Speaker Driver: 2"×4 PCS (Soundbar) +4"×1 PCS (Subwoofer)

Functional Jack: Optical *1, AUX *1, USB *1, TF *1

Power Supply: DC 18V \Rightarrow 2.33A AC 110-240V 50/60 Hz

Soundbar Dimensions: L806*W63*H60mm / 31.7*2.48*2.36 In

Soundbar Weight: 1.43 Kg / 3.15 Lbs

Subwoofer Dimensions: L140*W124*H300mm / 5.51*4.88*11.81 In

Subwoofer Weight: 1.89 Kg / 4.17 Lbs

EN:

Safety Instructions

1. Avoid dropping
2. Do not disassemble
3. Avoid extreme temperatures
4. Don't use the device outdoors during thunderstorms
5. Use original or certified cables
6. Don't use any corrosive cleaner / oil to clean
7. The products should not be exposed to dripping or splashing water

FR:

Consignes de sécurité

1. Éviter de laisser tomber
2. Ne pas désassembler
3. Éviter les températures extrêmes
4. Ne pas utiliser l'appareil à l'extérieur pendant les orages
5. Utilisez des câbles d'origine ou certifiés
6. Ne pas utiliser de nettoyant / huile corrosif pour nettoyer
7. Les produits ne doivent pas être exposés à des gouttes d'eau ou des éclaboussures

DE:

Sicherheitshinweise

1. Vermeiden Sie das Fallenlassen
2. Nicht auseinanderbauen
3. Extreme Temperaturen vermeiden
4. Verwenden Sie das Gerät nicht im Freien bei Gewitter
5. Verwenden Sie Original- oder
6. Verwenden Sie zum Reinigen kein ätzendes Reinigungsmittel / Öl
7. Die Produkte dürfen keinem tropfenden oder spritzenden Wasser ausgesetzt werden

ES:

Instrucciones de seguridad

1. Evite caer
2. No lo desarme
3. Evita las temperaturas extremas.
4. No use el dispositivo al aire libre durante tormentas eléctricas.
5. Utilice cables originales o certificados.
6. No use ningún limpiador / aceite corrosivo para limpiar.
7. Los productos no deben exponerse a goteos o salpicaduras de agua.

IT:

Istruzioni di sicurezza

1. Evitare di lasciar cadere
2. Non smontare
3. Evitare temperature estreme
4. Non utilizzare il dispositivo all'aperto durante i temporali
5. Utilizzare cavi originali o certificati
6. Non utilizzare detergenti corrosivi / olio per la pulizia
7. I prodotti non devono essere esposti a gocciolamento o spruzzi d'acqua

JP:

安全上のご注意

1. 落ちないように気をつけてください
2. 自分で分解しないでください
3. 温度が高すぎる、または低すぎることは避けてください。
4. 雷雨の間は屋外で本製品を使用しないでください
5. 原裝または認証ケーブルを使用してください
6. 腐食性洗剤を本製品を清潔にすることに使用しないでください
7. 本製品を水源から離れてください

FCC Regulatory Compliance

Note: This equipment has been tested and found to comply with the limits for a Class B digital device, pursuant to Part 15 of the FCC Rules. These limits are designed to provide reasonable protection against harmful interference in a residential installation. This equipment generates, uses and can radiate radio frequency energy and, if not installed and used in accordance with the instructions, may cause harmful interference to radio communications. However, there is no guarantee that interference will not occur in a particular installation.

If this equipment does cause harmful interference to radio or television reception, which can be determined by turning the equipment off and on, the user is encouraged to try to correct the interference by one or more of the following measures:

- Reorient or relocate the receiving antenna.
- Increase the separation between the equipment and receiver.
- Connect the equipment into an outlet on a circuit different from that to which the receiver is connected.
- Consult the dealer or an experienced radio/TV technician for help.

Warning: changes or modifications not expressly approved by the party responsible for compliance could void the user's authority to operate the equipment.

RF Exposure Compliance

This equipment complies with FCC radiation exposure limits set forth for an uncontrolled environment. This equipment should be installed and operated with minimum distance 20cm between the radiator and your body. This transmitter must not be co-located or operating in conjunction with any other antenna or transmitter.

FCC Compliance Statement

This device complies with Part 15 of the FCC Rules. Operation is subject to the following two conditions: (1) This device may not cause harmful interference, and (2) this device must accept any interference received, including interference that may cause undesired operation.

Supplier's Declaration of Conformity

47 CFR § 2.1077 Compliance Information

Unique Identifier Trade Name: Ultimea, Model No : Tapio V

Responsible Party - U.S. Contact Information

Substanbo Inc.

Suite A 6911 216th St SW, Lynnwood, WA 98036 USA

TEL: +1(206)-979-390"

ISED WARNINGS

This device contains licence-exempt transmitter(s)/receiver(s) that comply with Innovation, Science and Economic Development Canada's licence-exempt RSS(s). Operation is subject to the following two conditions:

- (1) This device may not cause interference.
- (2) This device must accept any interference, including interference that may cause undesired operation of the device.

L'émetteur/récepteur exempt de licence contenu dans le présent appareil est conforme aux CNR d'Innovation, Sciences et Développement économique Canada applicables aux appareils radio exempts de licence. L'exploitation est autorisée aux deux conditions suivantes :

- 1) L'appareil ne doit pas produire de brouillage;
- 2) L'appareil doit accepter tout brouillage radioélectrique subi, même si le brouillage est susceptible d'en compromettre le fonctionnement.

The device meets the exemption from the routine evaluation limits in section 2.5 of RSS 102 and compliance with RSS-102 RF exposure, users can obtain Canadian information on RF exposure and compliance.

Le dispositif rencontre l'exemption des limites courantes d'évaluation dans la section 2.5 de RSS 102 et la conformité à l'exposition de RSS-102 rf, utilisateur peut obtenir l'information canadienne sur l'exposition et la conformité de rf.

Declaration of Conformity

We (Manufacturer is responsible for this declaration)

Guang Dong Substanbo Technology Co., Ltd.

(Company name)

Room 2008, Bd.4, Tianan yungu 2nd Industrial Park, Longgang District Shenzhen,China

(Company address)

declare under our sole responsibility that the product

Trade name: Ultimea

Equipment: 2.1 Soundbar system

Model No. : **Tapio V**

to which this declaration relates is in conformity with the essential requirement set out in the Council Directive on the Approximation of the laws of the Member States relating to RED Directive(2014/53/EU) & RoHS(2011/65/EU) product is responsible to affix CE marking, the following standards were applied:

EN 55032:2015

EN 55035:2017

EN IC 61000-3-2:2019, EN 61000-3-3:2013+A1:2019

ETSI EN 301 489-1 V2.2.3 (2019-11)

Draft ETSI EN 301 489-17 V3.2.0 (2017-03)

EN 300 328 V2.2.2 (2019-07)

EN 62311: 2008

EN 62368-1:2014/A11:2017

IEC62321

Full Name: Lion Liao

Position: Approbation Manager

Signature:  Place/Date: Shenzhen,China/Apr-28-2022

Correct Disposal of This Product



(Waste Electrical & Electronic Equipment)

This mark shown on the product or its packaging, indicates that this product should not be disposed with other household wastes at the end of its working life.

To prevent possible harm to the environment or human health from uncontrolled waste disposal, please separate this from other types of wastes and recycle it responsibly to promote the sustainable reuse of material resources.

Household user should contact either the retailer where they purchased this product, or their local government office, for details of where and how they can take this item for environmentally safe recycling.

Business users should contact their supplier and check the terms and conditions of the purchase contract. This product should not be mixed with other commercial wastes for disposal.

ULTIMEA

✉ support@Utimea.com

🌐 www.Utimea.com



@Utimea

Made in China

