



## Shenzhen Huaxia Testing Technology Co., Ltd.

1F., Block A of Tongsheng Technology Building, Huahui Road, Dalang Street, Longhua District, Shenzhen, China

Telephone: +86-755-26648640

Fax: +86-755-26648637

Website: [www.cqa-cert.com](http://www.cqa-cert.com)

Report Template Version: V04

Report Template Revision Date: 2018-07-06

# Test Report

**Report No.:** CQASZ20220600945E-01  
**Applicant:** GuangDong Substanbo Technology Co., Ltd.  
**Address of Applicant:** 2008, Building 4, Tianan Cloud Park Phase II, Bantian Street, Longgang District, Shenzhen, China  
**Equipment Under Test (EUT):**  
**EUT Name:** 2.1CH SOUNDBAR SYSTEM  
**Model No.:** Tapio V  
**Brand Name:** Ultimea  
**FCC ID:** 2AS9D-TAPIOV  
**Standards:** 47 CFR Part 15, Subpart C  
**Date of Receipt:** 2020-06-15  
**Date of Test:** 2020-06-15 to 2020-06-29  
**Date of Issue:** 2022-6-22  
**Test Result:** **PASS\***

\*In the configuration tested, the EUT complied with the standards specified above

**Tested By:** \_\_\_\_\_

*Timo Lei*

( Timo Lei )

**Reviewed By:** \_\_\_\_\_

*K. Liao*

( K Liao )

**Approved By:** \_\_\_\_\_

*Jack Ai*

( Jack Ai )



## Version

### Revision History Of Report

| Report No.           | Version | Description    | Issue Date |
|----------------------|---------|----------------|------------|
| CQASZ20220600945E-01 | Rev.01  | Initial report | 2022-6-22  |

Note:

This test report (Ref. No.: CQASZ20220600945E-01)

All test data comes from source test reports (Ref. No.: CQASZ20200600545E-01).

Only on the basis of the original report Change Brand Name, Address of Applicant, Address of Manufacturer, Address of Factory. The tested samples have not been changed.

## 1 Test Summary

| Test Item   | Test Requirement  | Test method        | Result |
|---|---|--------------------|--------|
| Antenna Requirement   | 47 CFR Part 15, Subpart C Section 15.203/15.247 (c)                             | ANSI C63.10 (2013) | PASS   |
| AC Power Line Conducted Emission                                  | 47 CFR Part 15, Subpart C Section 15.207  | ANSI C63.10 (2013) | PASS   |
| Conducted Peak Output Power                                       | 47 CFR Part 15, Subpart C Section 15.247 (b)(1)                                 | ANSI C63.10 (2013) | PASS   |
| 20dB Occupied Bandwidth   | 47 CFR Part 15, Subpart C Section 15.247 (a)(1)                                 | ANSI C63.10 (2013) | PASS   |
| Carrier Frequencies Separation                                    | 47 CFR Part 15, Subpart C Section 15.247 (a)(1)                                 | ANSI C63.10 (2013) | PASS   |
| Hopping Channel Number  | 47 CFR Part 15, Subpart C Section 15.247 (a)(1)                                 | ANSI C63.10 (2013) | PASS   |
| Dwell Time  | 47 CFR Part 15, Subpart C Section 15.247 (a)(1)                                 | ANSI C63.10 (2013) | PASS   |
| Pseudorandom Frequency Hopping Sequence                           | 47 CFR Part 15, Subpart C Section 15.247(b)(4)&TCB Exclusion List (7 July 2002) | ANSI C63.10 (2013) | PASS   |
| Band-edge for RF Conducted Emissions                              | 47 CFR Part 15, Subpart C Section 15.247(d)                                     | ANSI C63.10 (2013) | PASS   |
| RF Conducted Spurious Emissions                                   | 47 CFR Part 15, Subpart C Section 15.247(d)                                     | ANSI C63.10 (2013) | PASS   |
| Radiated Spurious emissions                                       | 47 CFR Part 15, Subpart C Section 15.205/15.209                                 | ANSI C63.10 (2013) | PASS   |
| Restricted bands around fundamental frequency (Radiated Emission) | 47 CFR Part 15, Subpart C Section 15.205/15.209                                 | ANSI C63.10 (2013) | PASS   |

## 2 Contents

|  | Page      |
|--|-----------|
| <b>1 VERSION</b> .....   | <b>2</b>  |
| <b>2 TEST SUMMARY</b> .....  | <b>3</b>  |
| <b>3 CONTENTS</b> .....  | <b>4</b>  |
| <b>4 GENERAL INFORMATION</b> .....                                     | <b>5</b>  |
| 4.1 CLIENT INFORMATION .....   | 5         |
| 4.2 GENERAL DESCRIPTION OF EUT .....                                   | 5         |
| 4.3 ADDITIONAL INSTRUCTIONS .....                                      | 7         |
| 4.4 TEST ENVIRONMENT .....   | 8         |
| 4.5 DESCRIPTION OF SUPPORT UNITS .....                                 | 8         |
| 4.6 STATEMENT OF THE MEASUREMENT UNCERTAINTY .....                     | 9         |
| 4.7 TEST LOCATION .....  | 10        |
| 4.8 TEST FACILITY .....  | 10        |
| 4.9 ABNORMALITIES FROM STANDARD CONDITIONS .....                       | 10        |
| 4.10 OTHER INFORMATION REQUESTED BY THE CUSTOMER .....                 | 10        |
| 4.11 EQUIPMENT LIST .....  | 11        |
| <b>5 TEST RESULTS AND MEASUREMENT DATA</b> .....                       | <b>12</b> |
| 5.1 ANTENNA REQUIREMENT .....  | 12        |
| 5.2 CONDUCTED EMISSIONS .....  | 13        |
| 5.3 CONDUCTED PEAK OUTPUT POWER .....                                  | 17        |
| 5.4 20dB OCCUPY BANDWIDTH .....  | 24        |
| 5.5 CARRIER FREQUENCIES SEPARATION .....                               | 30        |
| 5.6 HOPPING CHANNEL NUMBER .....                                       | 37        |
| 5.7 DWELL TIME .....   | 40        |
| 5.8 BAND-EDGE FOR RF CONDUCTED EMISSIONS .....                         | 56        |
| 5.9 SPURIOUS RF CONDUCTED EMISSIONS .....                              | 64        |
| 5.10 OTHER REQUIREMENTS FREQUENCY HOPPING SPREAD SPECTRUM SYSTEM ..... | 83        |
| 5.11 RADIATED SPURIOUS EMISSION & RESTRICTED BANDS .....               | 85        |
| 5.11.1 Radiated Emission below 1GHz .....                              | 88        |
| 5.11.2 Transmitter Emission above 1GHz .....                           | 90        |
| <b>6 PHOTOGRAPHS - EUT TEST SETUP</b> .....                            | <b>93</b> |
| 6.1 RADIATED EMISSION .....  | 93        |
| 6.2 CONDUCTED EMISSION .....   | 94        |
| <b>7 PHOTOGRAPHS - EUT CONSTRUCTIONAL DETAILS</b> .....                | <b>95</b> |

### 3 General Information

#### 3.1 Client Information

|                          |  |
|--------------------------|--|
| Applicant:               | GuangDong Substanbo Technology Co., Ltd.   |
| Address of Applicant:    | 2008, Building 4, Tianan Cloud Park Phase II, Bantian Street, Longgang District, Shenzhen, China |
| Manufacturer:            | GuangDong Substanbo Technology Co., Ltd.   |
| Address of Manufacturer: | 2008, Building 4, Tianan Cloud Park Phase II, Bantian Street, Longgang District, Shenzhen, China |
| Factory:                 | SHENZHEN MENGXIANG TECHNOLOGY CO.,LTD.   |
| Address of Factory:      | 3rd Floor, Building 16, Tongfutun Industrial Zone, Dalang Street, Longhua New District, Shenzhen |

#### 3.2 General Description of EUT

|                       |  |
|-----------------------|--|
| Product Name:         | 2.1CH SOUNDBAR SYSTEM  |
| Model No.:            | Tapio V  |
| Trade Mark:           | Ultimea  |
| Hardware Version:     | 1.0  |
| Software Version:     | V5.0   |
| Operation Frequency:  | 2402MHz~2480MHz  |
| Bluetooth Version:    | V5.0   |
| Modulation Technique: | Frequency Hopping Spread Spectrum(FHSS)  |
| Modulation Type:      | GFSK, $\pi/4$ DQPSK, 8DPSK   |
| Transfer Rate:        | 1Mbps/2Mbps/3Mbps  |
| Number of Channel:    | 79   |
| Hopping Channel Type: | Adaptive Frequency Hopping systems   |
| Product Type:         | <input type="checkbox"/> Mobile <input type="checkbox"/> Portable <input checked="" type="checkbox"/> Fix Location |
| Test Software of EUT: | BT_Tool (manufacturer declare)   |
| Antenna Type:         | PCB antenna  |
| Antenna Gain:         | 1.7dBi   |
| Power Supply:         | Adapter:<br>MODEL NO.: CW1802330RE<br>INPUT: 100-240V~50/60Hz 1.2A MAX<br>OUTPUT: 18V 2330mA                       |

| Operation Frequency each of channel |           |         |           |         |           |         |           |
|-------------------------------------|-----------|---------|-----------|---------|-----------|---------|-----------|
| Channel                             | Frequency | Channel | Frequency | Channel | Frequency | Channel | Frequency |
| 0                                   | 2402MHz   | 20      | 2422MHz   | 40      | 2442MHz   | 60      | 2462MHz   |
| 1                                   | 2403MHz   | 21      | 2423MHz   | 41      | 2443MHz   | 61      | 2463MHz   |
| 2                                   | 2404MHz   | 22      | 2424MHz   | 42      | 2444MHz   | 62      | 2464MHz   |
| 3                                   | 2405MHz   | 23      | 2425MHz   | 43      | 2445MHz   | 63      | 2465MHz   |
| 4                                   | 2406MHz   | 24      | 2426MHz   | 44      | 2446MHz   | 64      | 2466MHz   |
| 5                                   | 2407MHz   | 25      | 2427MHz   | 45      | 2447MHz   | 65      | 2467MHz   |
| 6                                   | 2408MHz   | 26      | 2428MHz   | 46      | 2448MHz   | 66      | 2468MHz   |
| 7                                   | 2409MHz   | 27      | 2429MHz   | 47      | 2449MHz   | 67      | 2469MHz   |
| 8                                   | 2410MHz   | 28      | 2430MHz   | 48      | 2450MHz   | 68      | 2470MHz   |
| 9                                   | 2411MHz   | 29      | 2431MHz   | 49      | 2451MHz   | 69      | 2471MHz   |
| 10                                  | 2412MHz   | 30      | 2432MHz   | 50      | 2452MHz   | 70      | 2472MHz   |
| 11                                  | 2413MHz   | 31      | 2433MHz   | 51      | 2453MHz   | 71      | 2473MHz   |
| 12                                  | 2414MHz   | 32      | 2434MHz   | 52      | 2454MHz   | 72      | 2474MHz   |
| 13                                  | 2415MHz   | 33      | 2435MHz   | 53      | 2455MHz   | 73      | 2475MHz   |
| 14                                  | 2416MHz   | 34      | 2436MHz   | 54      | 2456MHz   | 74      | 2476MHz   |
| 15                                  | 2417MHz   | 35      | 2437MHz   | 55      | 2457MHz   | 75      | 2477MHz   |
| 16                                  | 2418MHz   | 36      | 2438MHz   | 56      | 2458MHz   | 76      | 2478MHz   |
| 17                                  | 2419MHz   | 37      | 2439MHz   | 57      | 2459MHz   | 77      | 2479MHz   |
| 18                                  | 2420MHz   | 38      | 2440MHz   | 58      | 2460MHz   | 78      | 2480MHz   |
| 19                                  | 2421MHz   | 39      | 2441MHz   | 59      | 2461MHz   |         |           |

Note:

In section 15.31(m), regards to the operating frequency range over 10 MHz, the Lowest frequency, the middle frequency, and the highest frequency of channel were selected to perform the test, and the selected channel see below:

| Channel             | Frequency |
|---------------------|-----------|
| The Lowest channel  | 2402MHz   |
| The Middle channel  | 2441MHz   |
| The Highest channel | 2480MHz   |

### 3.3 Additional Instructions

| EUT Test Software Settings:   |   |                |
|---|---|----------------|
| Mode:   | <input checked="" type="checkbox"/> Special software is used.<br><input type="checkbox"/> Through engineering command into the engineering mode.<br>engineering command: <code>###3646633###</code> |                |
| EUT Power level:  | Class2 (Power level is built-in set parameters and cannot be changed and selected)  |                |
| Use test software to set the lowest frequency, the middle frequency and the highest frequency keep transmitting of the EUT. |   |                |
| Mode  | Channel   | Frequency(MHz) |
| DH1/DH3/DH5   | CH0   | 2402           |
|   | CH39  | 2441           |
|   | CH78  | 2480           |
| 2DH1/2DH3/2DH5  | CH0   | 2402           |
|   | CH39  | 2441           |
|   | CH78  | 2480           |
| 3DH1/3DH3/3DH5  | CH0   | 2402           |
|   | CH39  | 2441           |
|   | CH78  | 2480           |

#### Run Software:

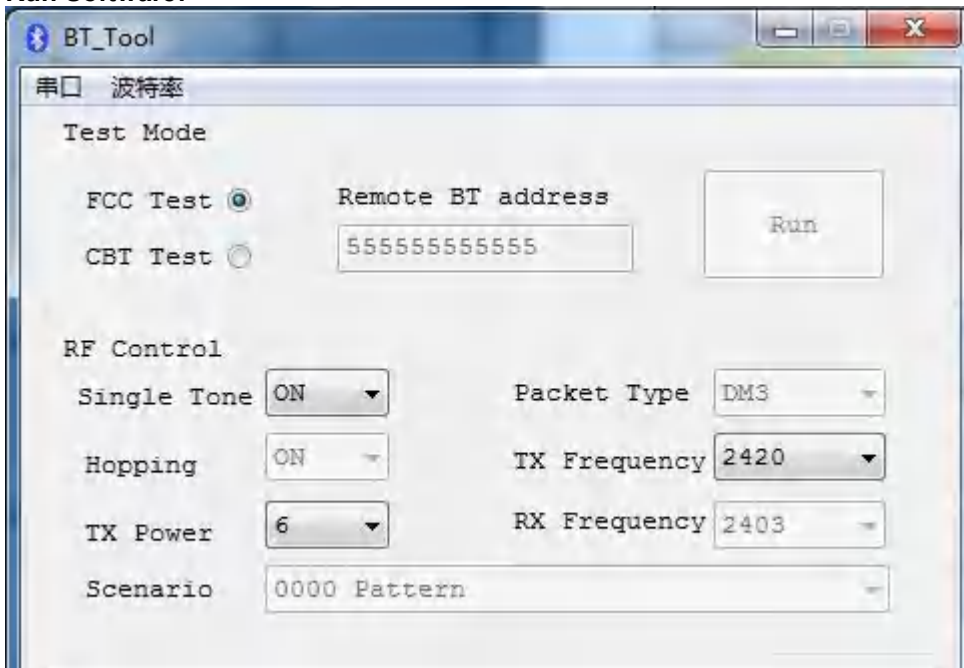

### 3.4 Test Environment

|  |   |
|--|---|
| <b>Operating Environment:</b>                              |   |
| <b>Radiated Emissions:</b>                                 |   |
| Temperature:   | 25.7 °C   |
| Humidity:  | 54 % RH   |
| Atmospheric Pressure:                                      | 1009 mbar   |
| <b>Conducted Emissions:</b>                                |   |
| Temperature:   | 25.8 °C   |
| Humidity:  | 56 % RH   |
| Atmospheric Pressure:                                      | 1009 mbar   |
| <b>Radio conducted item test (RF Conducted test room):</b> |   |
| Temperature:   | 28.0 °C   |
| Humidity:  | 67 % RH   |
| Atmospheric Pressure:                                      | 1009 mbar   |
| <b>Test mode:</b>  |   |
| Test Mode:   | Use test software to set the lowest frequency, the middle frequency and the highest frequency keep transmitting of the EUT. |

### 3.5 Description of Support Units

The EUT has been tested with associated equipment below.

1) Support equipment

| Description | Manufacturer | Model No.      | Certification | Supplied by |
|-------------|--------------|----------------|---------------|-------------|
| PC          | Lenovo       | ThinkPad E450c | FCC ID        | CQA         |

2) Cable

| Cable No. | Description | Manufacturer | Cable Type/Length | Supplied by |
|-----------|-------------|--------------|-------------------|-------------|
| /         | /           | /            | /                 | /           |



### 3.6 Statement of the measurement uncertainty

The data and results referenced in this document are true and accurate.

The reader is cautioned that there may be errors within the calibration limits of the equipment and facilities.

The measurement uncertainty was calculated for all measurements listed in this test report acc. to CISPR 16 - 4 „Specification for radio disturbance and immunity measuring apparatus and methods – Part 4: Uncertainty in EMC Measurements“ and is documented in the **Shenzhen Huaxia Testing Technology Co., Ltd.** quality system acc. to DIN EN ISO/IEC 17025.

Furthermore, component and process variability of devices similar to that tested may result in additional deviation. The manufacturer has the sole responsibility of continued compliance of the device.

Hereafter the best measurement capability for CQA laboratory is reported:

| No. | Item                               | Uncertainty        | Notes |
|-----|------------------------------------|--------------------|-------|
| 1   | Radiated Emission (Below 1GHz)     | 5.12dB             | (1)   |
| 2   | Radiated Emission (Above 1GHz)     | 4.60dB             | (1)   |
| 3   | Conducted Disturbance (0.15~30MHz) | 3.34dB             | (1)   |
| 4   | Radio Frequency                    | $3 \times 10^{-8}$ | (1)   |
| 5   | Duty cycle                         | 0.6 %.             | (1)   |
| 6   | Occupied Bandwidth                 | 1.1%               | (1)   |
| 7   | RF conducted power                 | 0.86dB             | (1)   |
| 8   | RF power density                   | 0.74               | (1)   |
| 9   | Conducted Spurious emissions       | 0.86dB             | (1)   |
| 10  | Temperature test                   | 0.8°C              | (1)   |
| 11  | Humidity test                      | 2.0%               | (1)   |
| 12  | Supply voltages                    | 0.5 %.             | (1)   |
| 13  | Frequency Error                    | 5.5 Hz             | (1)   |

(1) This uncertainty represents an expanded uncertainty expressed at approximately the 95% confidence level using a coverage factor of k=2.

### 3.7 Test Location

**Shenzhen Huaxia Testing Technology Co., Ltd.**

1F., Block A of Tongsheng Technology Building, Huahui Road, Dalang Street, Longhua District, Shenzhen, China

### 3.8 Test Facility

• **A2LA (Certificate No. 4742.01)**

Shenzhen Huaxia Testing Technology Co., Ltd., Shenzhen EMC Laboratory is accredited by the American Association for Laboratory Accreditation(A2LA). Certificate No. 4742.01.

• **FCC Registration No.: 522263**

Shenzhen Huaxia Testing Technology Co., Ltd., Shenzhen EMC Laboratory has been registered and fully described in a report filed with the (FCC) Federal Communications Commission. The acceptance letter from the FCC is maintained in our files. Registration No.:522263

### 3.9 Abnormalities from Standard Conditions

None.

### 3.10 Other Information Requested by the Customer

None.

### 3.11 Equipment List

| Test Equipment             | Manufacturer | Model No.              | Instrument No. | Calibration Date | Calibration Due Date |
|----------------------------|--------------|------------------------|----------------|------------------|----------------------|
| EMI Test Receiver          | R&S          | ESR7                   | CQA-005        | 2019/10/25       | 2020/10/24           |
| Spectrum analyzer          | R&S          | FSU26                  | CQA-038        | 2019/10/25       | 2020/10/24           |
| Preamplifier               | MITEQ        | AMF-6D-02001800-29-20P | CQA-036        | 2019/10/25       | 2020/10/24           |
| Loop antenna               | Schwarzbeck  | FMZB1516               | CQA-060        | 2019/10/21       | 2020/10/20           |
| Bilog Antenna              | R&S          | HL562                  | CQA-011        | 2019/9/26        | 2020/9/25            |
| Horn Antenna               | R&S          | HF906                  | CQA-012        | 2019/9/26        | 2020/9/25            |
| Horn Antenna               | Schwarzbeck  | BBHA 9170              | CQA-088        | 2019/9/25        | 2020/9/24            |
| Coaxial Cable (Above 1GHz) | CQA          | N/A                    | C007           | 2019/9/26        | 2020/9/25            |
| Coaxial Cable (Below 1GHz) | CQA          | N/A                    | C013           | 2019/9/26        | 2020/9/25            |
| Antenna Connector          | CQA          | RFC-01                 | CQA-080        | 2019/9/26        | 2020/9/25            |
| RF cable(9kHz~40GHz)       | CQA          | RF-01                  | CQA-079        | 2019/9/26        | 2020/9/25            |
| Power divider              | MIDWEST      | PWD-2533-02-SMA-79     | CQA-067        | 2019/9/26        | 2020/9/25            |
| EMI Test Receiver          | R&S          | ESR7                   | CQA-005        | 2019/10/25       | 2020/10/24           |
| LISN                       | R&S          | ENV216                 | CQA-003        | 2019/10/23       | 2020/10/22           |
| Coaxial cable              | CQA          | N/A                    | CQA-C009       | 2019/9/26        | 2020/9/25            |
| DC power                   | KEYSIGHT     | E3631A                 | CQA-028        | 2019/9/26        | 2020/9/25            |

Note:

The temporary antenna connector is soldered on the PCB board in order to perform conducted tests and this temporary antenna connector is listed in the equipment list.

## 4 Test results and Measurement Data

### 4.1 Antenna Requirement

|  |   |
|--|---|
| <b>Standard requirement:</b>   | 47 CFR Part 15C Section 15.203 /247(c)  |
| <p>15.203 requirement:<br/>         An intentional radiator shall be designed to ensure that no antenna other than that furnished by the responsible party shall be used with the device. The use of a permanently attached antenna or of an antenna that uses a unique coupling to the intentional radiator, the manufacturer may design the unit so that a broken antenna can be replaced by the user, but the use of a standard antenna jack or electrical connector is prohibited.</p> <p>15.247(b) (4) requirement:<br/>         The conducted output power limit specified in paragraph (b) of this section is based on the use of antennas with directional gains that do not exceed 6 dBi. Except as shown in paragraph (c) of this section, if transmitting antennas of directional gain greater than 6 dBi are used, the conducted output power from the intentional radiator shall be reduced below the stated values in paragraphs (b)(1), (b)(2), and (b)(3) of this section, as appropriate, by the amount in dB that the directional gain of the antenna exceeds 6 dBi.</p> |   |
| <b>EUT Antenna:</b>  |  |
| <p>The antenna is PCB antenna. The best case gain of the antenna is 1.7dBi.</p>  |   |

## 4.2 Conducted Emissions

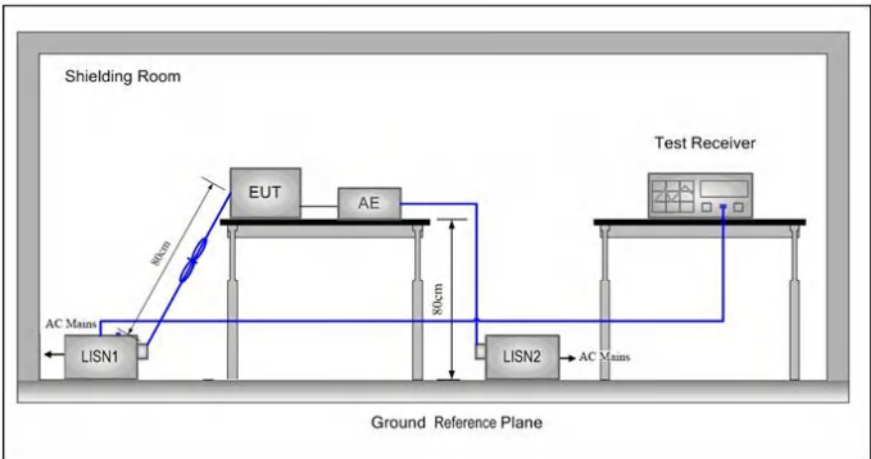
|                       |   |              |           |
|-----------------------|---|--------------|-----------|
| Test Requirement:     | 47 CFR Part 15C Section 15.207  |              |           |
| Test Method:          | ANSI C63.10: 2013   |              |           |
| Test Frequency Range: | 150kHz to 30MHz   |              |           |
| Limit:                | Frequency range (MHz)   | Limit (dBuV) |           |
|                       |   | Quasi-peak   | Average   |
|                       | 0.15-0.5  | 66 to 56*    | 56 to 46* |
|                       | 0.5-5   | 56           | 46        |
|                       | 5-30  | 60           | 50        |
|                       | * Decreases with the logarithm of the frequency.  |              |           |
| Test Procedure:       | <ol style="list-style-type: none"> <li>1) The mains terminal disturbance voltage test was conducted in a shielded room.</li> <li>2) The EUT was connected to AC power source through a LISN 1 (Line Impedance Stabilization Network) which provides a <math>50\Omega/50\mu\text{H} + 5\Omega</math> linear impedance. The power cables of all other units of the EUT were connected to a second LISN 2, which was bonded to the ground reference plane in the same way as the LISN 1 for the unit being measured. A multiple socket outlet strip was used to connect multiple power cables to a single LISN provided the rating of the LISN was not exceeded.</li> <li>3) The tabletop EUT was placed upon a non-metallic table 0.8m above the ground reference plane. And for floor-standing arrangement, the EUT was placed on the horizontal ground reference plane,</li> <li>4) The test was performed with a vertical ground reference plane. The rear of the EUT shall be 0.4 m from the vertical ground reference plane. The vertical ground reference plane was bonded to the horizontal ground reference plane. The LISN 1 was placed 0.8 m from the boundary of the unit under test and bonded to a ground reference plane for LISNs mounted on top of the ground reference plane. This distance was between the closest points of the LISN 1 and the EUT. All other units of the EUT and associated equipment was at least 0.8 m from the LISN 2.</li> <li>5) In order to find the maximum emission, the relative positions of equipment and all of the interface cables must be changed according to ANSI C63.10: 2013 on conducted measurement.</li> </ol> |              |           |
| Test Setup:           |   |              |           |

|                        |  |
|------------------------|--|
| Exploratory Test Mode: | Non-hopping transmitting mode with all kind of modulation and all kind of data type at the lowest, middle, high channel.                                     |
| Final Test Mode:       | Through Pre-scan, find the 3DH5 of data type and 8DPSK modulation at the lowest channel is the worst case.<br>Only the worst case is recorded in the report. |
| Test Voltage:          | AC 120V/60Hz   |
| Test Results:          | Pass   |

Measurement Data

Live line:

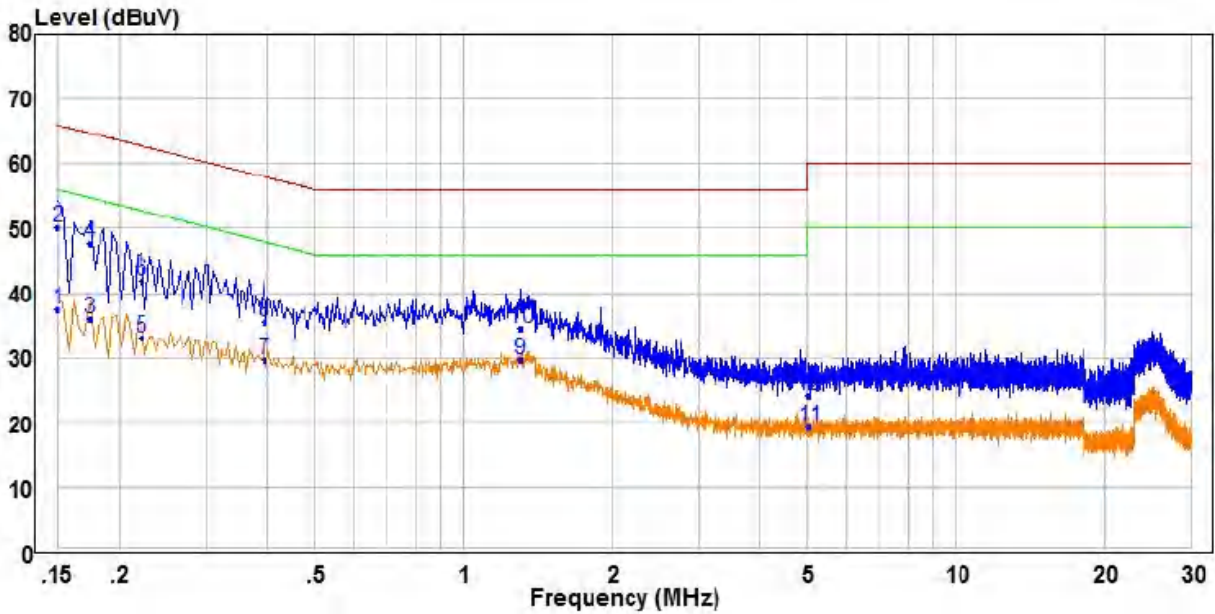

|      | Read  | Limit  | Over  |       |       |        |           |         |      |
|------|-------|--------|-------|-------|-------|--------|-----------|---------|------|
| Freq | Level | Factor | Level | Line  | Limit | Remark | Pol/Phase |         |      |
| MHz  | dBuV  | dB     | dBuV  | dBuV  | dB    |        |           |         |      |
| 1    | 0.150 | 27.98  | 9.49  | 37.47 | 56.00 | -18.53 | Average   | Line    |      |
| 2    | PP    | 0.150  | 40.73 | 9.49  | 50.22 | 66.00  | -15.78    | QP      | Line |
| 3    | 0.174 | 26.55  | 9.49  | 36.04 | 54.77 | -18.73 | Average   | Line    |      |
| 4    | 0.174 | 38.14  | 9.49  | 47.63 | 64.77 | -17.14 | QP        | Line    |      |
| 5    | 0.222 | 23.53  | 9.49  | 33.02 | 52.74 | -19.72 | Average   | Line    |      |
| 6    | 0.222 | 32.32  | 9.49  | 41.81 | 62.74 | -20.93 | QP        | Line    |      |
| 7    | 0.394 | 20.15  | 9.51  | 29.66 | 47.98 | -18.32 | Average   | Line    |      |
| 8    | 0.394 | 26.00  | 9.51  | 35.51 | 57.98 | -22.47 | QP        | Line    |      |
| 9    | AV    | 1.306  | 20.17 | 9.53  | 29.70 | 46.00  | -16.30    | Average | Line |
| 10   | 1.306 | 25.09  | 9.53  | 34.62 | 56.00 | -21.38 | QP        | Line    |      |
| 11   | 5.050 | 9.37   | 9.74  | 19.11 | 50.00 | -30.89 | Average   | Line    |      |
| 12   | 5.050 | 14.43  | 9.74  | 24.17 | 60.00 | -35.83 | QP        | Line    |      |

Remark:

1. The following Quasi-Peak and Average measurements were performed on the EUT:
2. Final Test Level =Receiver Reading + LISN Factor + Cable Loss.
3. If the Peak value under Average limit, the Average value is not recorded in the report.

Neutral line:

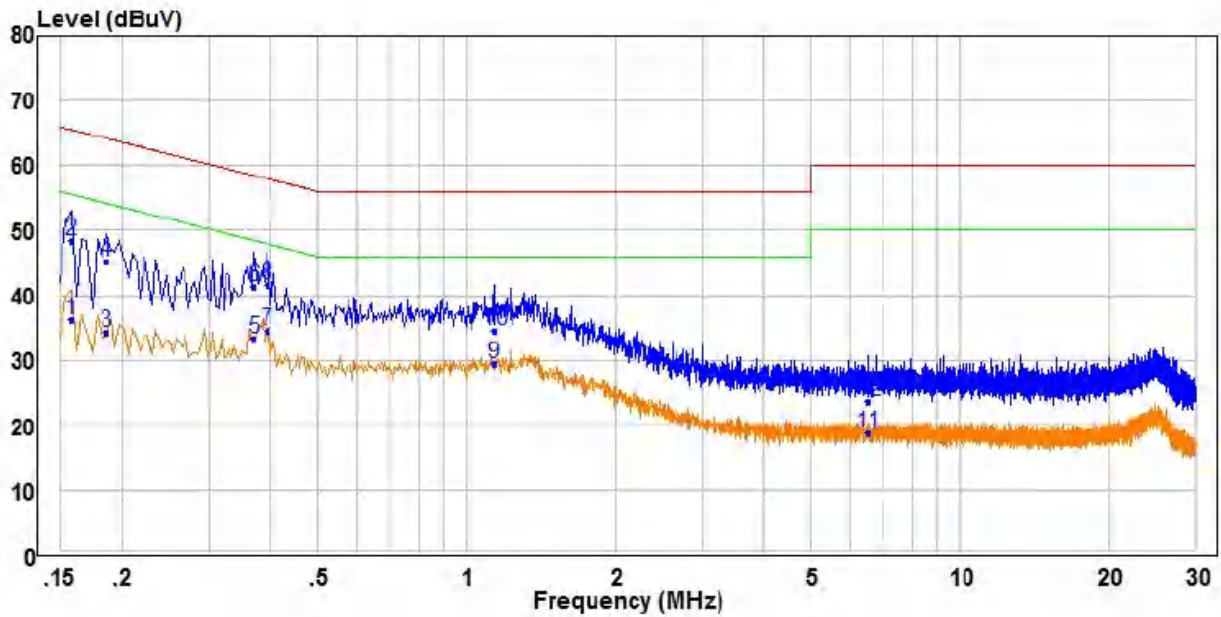

|    | Freq  | Read Level | Factor | Level | Limit Line | Over Limit | Remark  | Pol/Phase |         |
|----|-------|------------|--------|-------|------------|------------|---------|-----------|---------|
|    | MHz   | dBuV       | dB     | dBuV  | dBuV       | dB         |         |           |         |
| 1  | 0.158 | 26.74      | 9.48   | 36.22 | 55.57      | -19.35     | Average | Neutral   |         |
| 2  | 0.158 | 38.90      | 9.48   | 48.38 | 65.57      | -17.19     | QP      | Neutral   |         |
| 3  | 0.186 | 24.89      | 9.48   | 34.37 | 54.21      | -19.84     | Average | Neutral   |         |
| 4  | 0.186 | 35.83      | 9.48   | 45.31 | 64.21      | -18.90     | QP      | Neutral   |         |
| 5  | 0.370 | 23.76      | 9.53   | 33.29 | 48.50      | -15.21     | Average | Neutral   |         |
| 6  | 0.370 | 31.77      | 9.53   | 41.30 | 58.50      | -17.20     | QP      | Neutral   |         |
| 7  | PP    | 0.394      | 24.90  | 9.54  | 34.44      | 47.98      | -13.54  | Average   | Neutral |
| 8  | QP    | 0.394      | 32.04  | 9.54  | 41.58      | 57.98      | -16.40  | QP        | Neutral |
| 9  | 1.138 | 19.72      | 9.72   | 29.44 | 46.00      | -16.56     | Average | Neutral   |         |
| 10 | 1.138 | 24.74      | 9.72   | 34.46 | 56.00      | -21.54     | QP      | Neutral   |         |
| 11 | 6.506 | 8.93       | 9.79   | 18.72 | 50.00      | -31.28     | Average | Neutral   |         |
| 12 | 6.506 | 13.75      | 9.79   | 23.54 | 60.00      | -36.46     | QP      | Neutral   |         |

Remark:

1. The following Quasi-Peak and Average measurements were performed on the EUT:
2. Final Test Level =Receiver Reading + LISN Factor + Cable Loss.
3. If the Peak value under Average limit, the Average value is not recorded in the report.

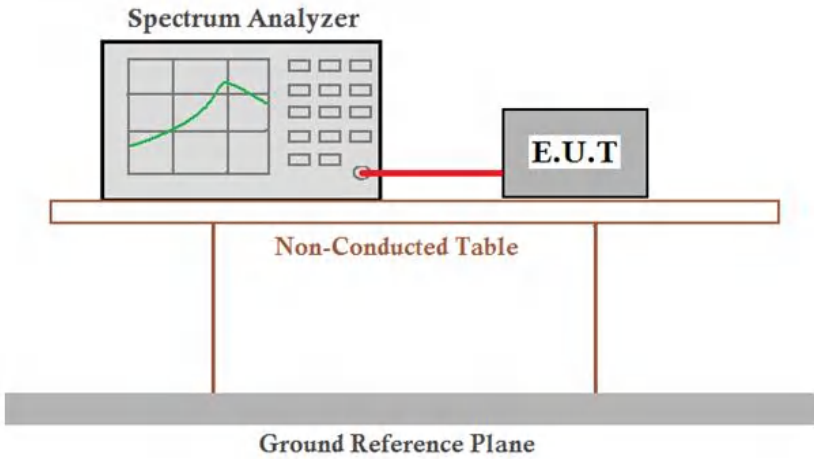

### 4.3 Conducted Peak Output Power

|                        |  |
|------------------------|--|
| Test Requirement:      | 47 CFR Part 15C Section 15.247 (b)(1)  |
| Test Method:           | ANSI C63.10:2013   |
| Test Setup:            |  <p style="text-align: center;"><i>Remark: Offset=Cable loss+ attenuation factor.</i></p>  |
| Limit:                 | 21dBm  |
| Exploratory Test Mode: | Non-hopping transmitting with all kind of modulation and all kind of data type   |
| Final Test Mode:       | Through Pre-scan, find the DH5 of data type is the worst case of GFSK modulation type, 2-DH5 of data type is the worst case of $\pi/4$ DQPSK modulation type, 3-DH5 of data type is the worst case of 8DPSK modulation type.<br>Only the worst case is recorded in the report. |
| Test Results:          | Pass   |

**Measurement Data**

| GFSK mode          |                         |             |        |
|--------------------|-------------------------|-------------|--------|
| Test channel       | Peak Output Power (dBm) | Limit (dBm) | Result |
| Lowest             | -3.030                  | 21.00       | Pass   |
| Middle             | -4.230                  | 21.00       | Pass   |
| Highest            | -4.990                  | 21.00       | Pass   |
| $\pi/4$ DQPSK mode |                         |             |        |
| Test channel       | Peak Output Power (dBm) | Limit (dBm) | Result |
| Lowest             | -0.780                  | 21.00       | Pass   |
| Middle             | -2.050                  | 21.00       | Pass   |
| Highest            | -2.880                  | 21.00       | Pass   |
| 8DPSK mode         |                         |             |        |
| Test channel       | Peak Output Power (dBm) | Limit (dBm) | Result |
| Lowest             | -0.260                  | 21.00       | Pass   |
| Middle             | -1.580                  | 21.00       | Pass   |
| Highest            | -2.420                  | 21.00       | Pass   |

Test plot as follows:

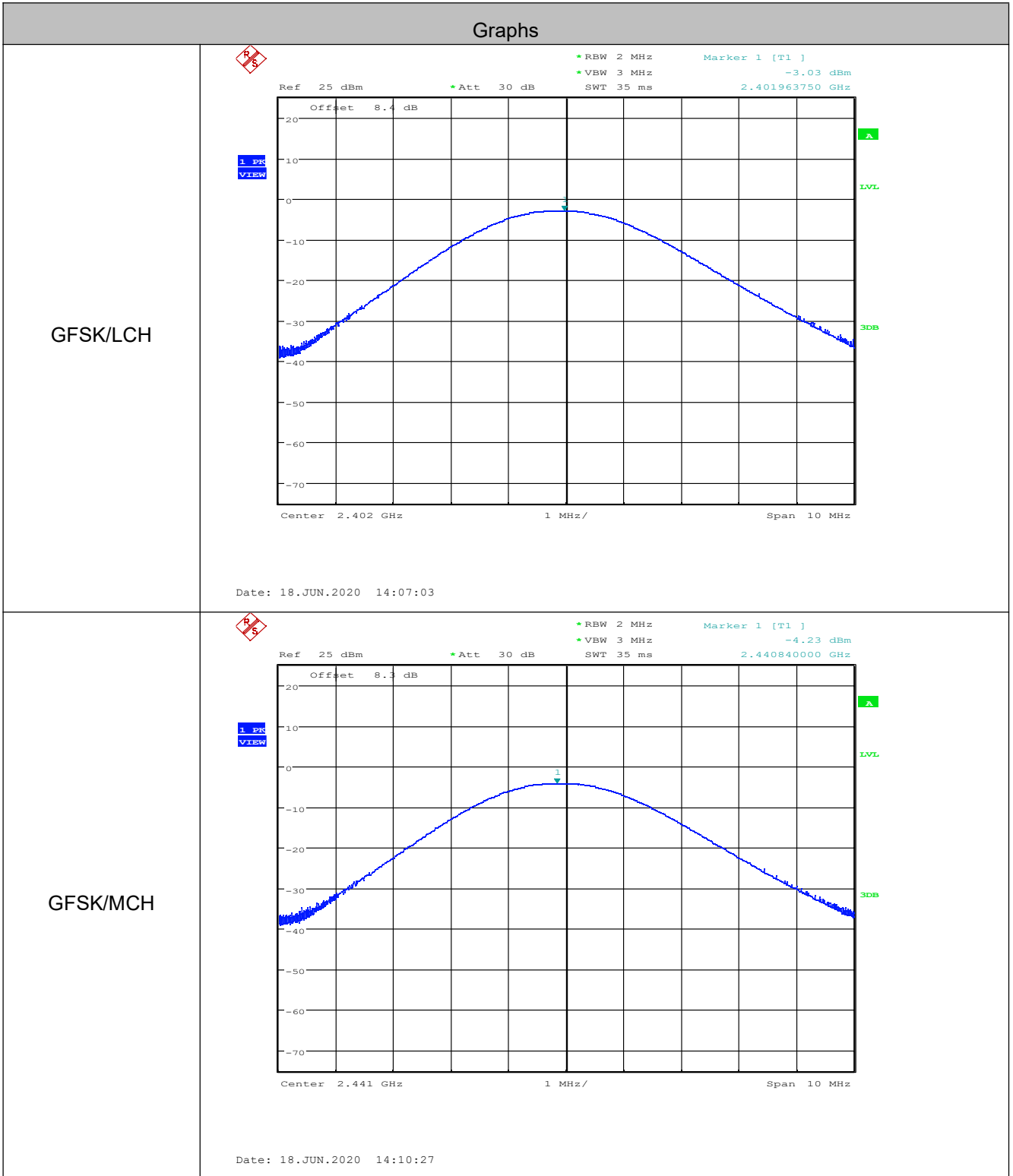

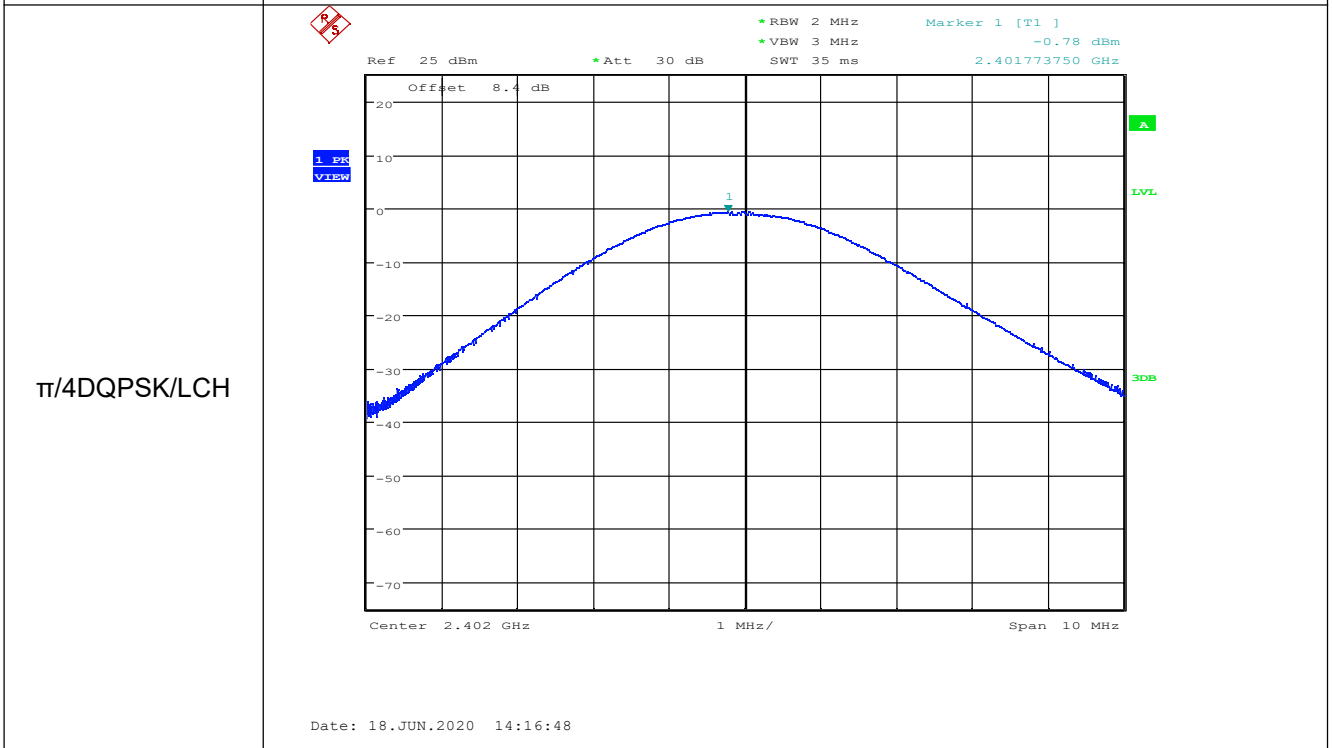

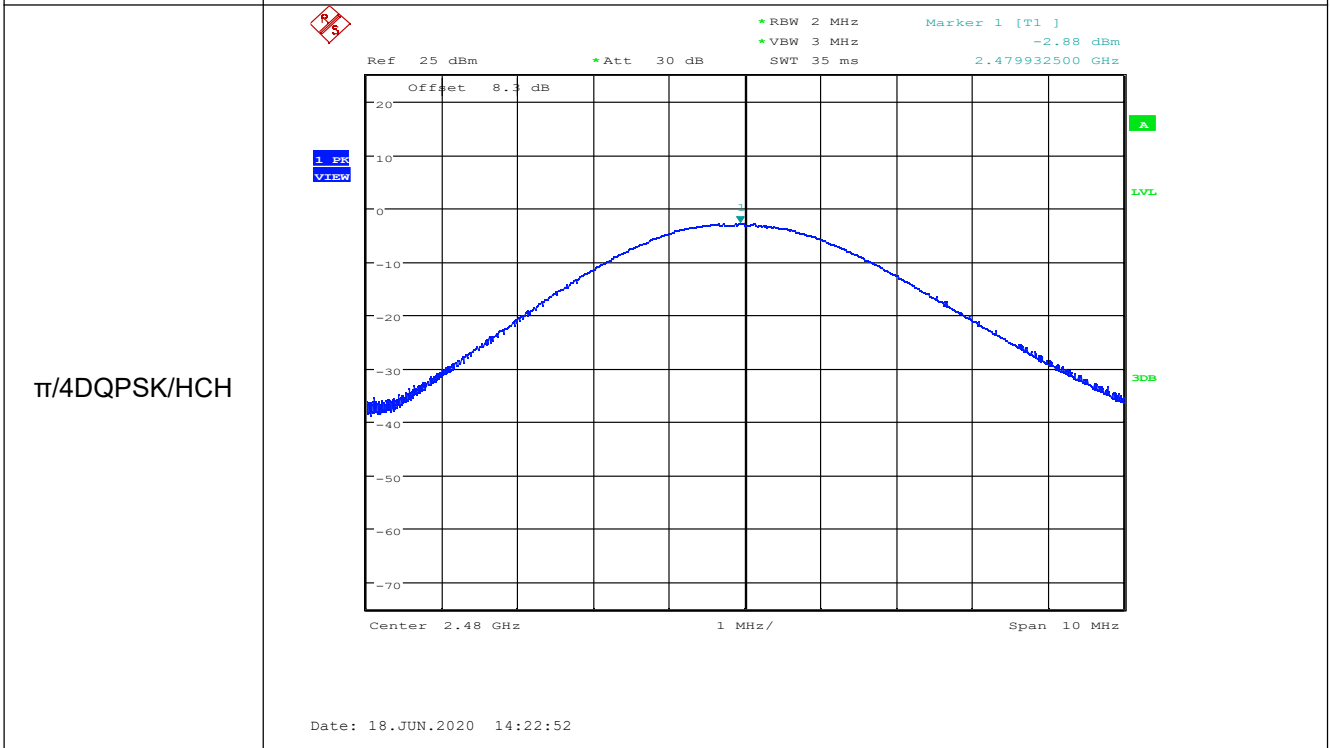

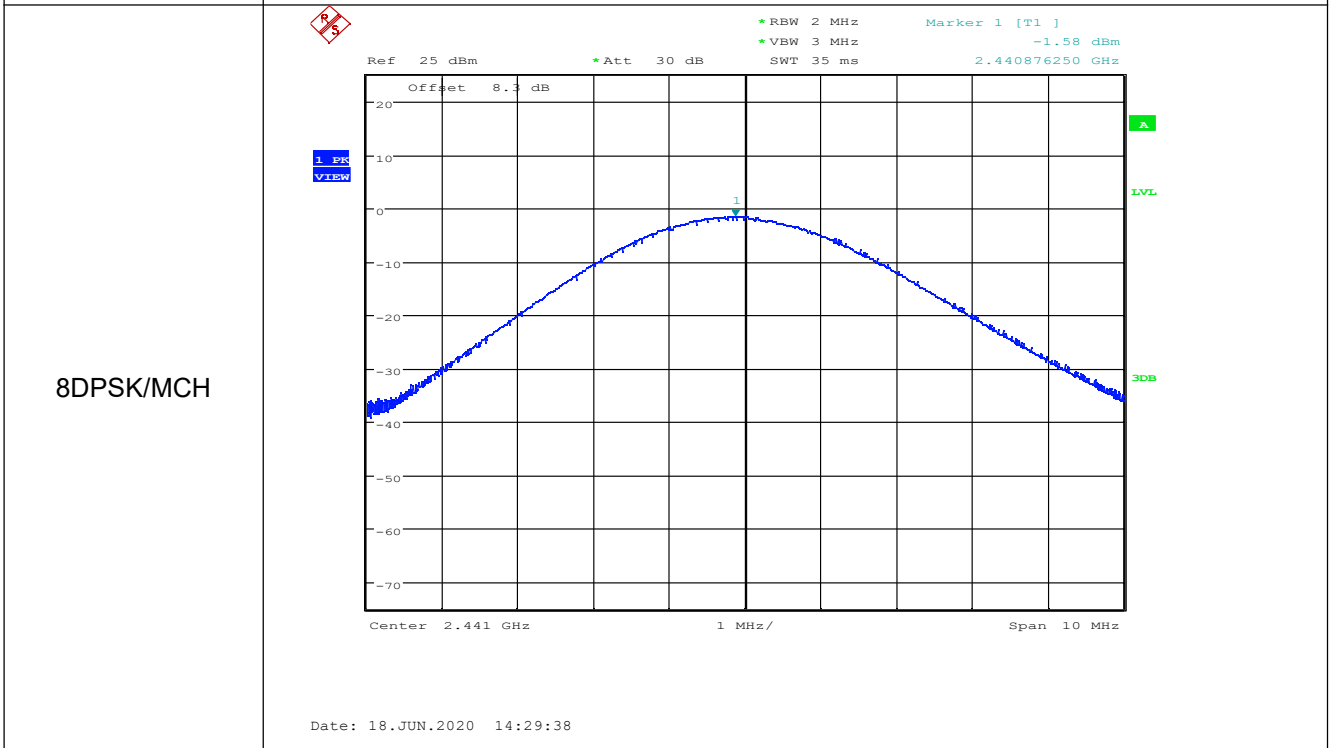

8DPSK/HCH

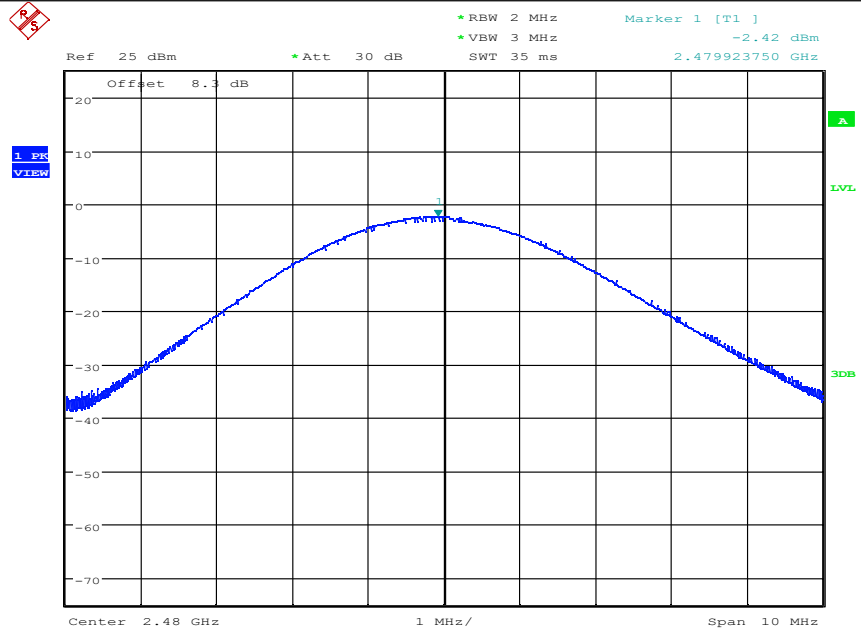

Date: 18.JUN.2020 14:32:41

#### 4.4 20dB Occupy Bandwidth

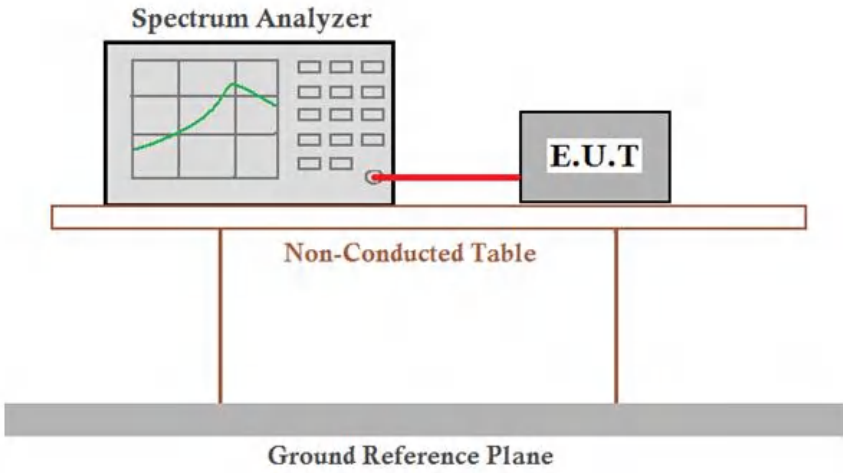
|                        |  |
|------------------------|--|
| Test Requirement:      | 47 CFR Part 15C Section 15.247 (a)(1)  |
| Test Method:           | ANSI C63.10:2013   |
| Test Setup:            |  <p>Remark: Offset=Cable loss+ attenuation factor.</p>   |
| Limit:                 | NA   |
| Exploratory Test Mode: | Non-hopping transmitting with all kind of modulation and all kind of data type   |
| Final Test Mode:       | Through Pre-scan, find the DH5 of data type is the worst case of GFSK modulation type, 2-DH5 of data type is the worst case of $\pi/4$ DQPSK modulation type, 3-DH5 of data type is the worst case of 8DPSK modulation type.<br>Only the worst case is recorded in the report. |
| Test Results:          | Pass   |

#### Measurement Data

| Test channel | 20dB Occupy Bandwidth (MHz) |               |       |
|--------------|-----------------------------|---------------|-------|
|              | GFSK                        | $\pi/4$ DQPSK | 8DPSK |
| Lowest       | 0.952                       | 1.322         | 1.308 |
| Middle       | 0.950                       | 1.324         | 1.308 |
| Highest      | 0.952                       | 1.322         | 1.308 |



Test plot as follows:

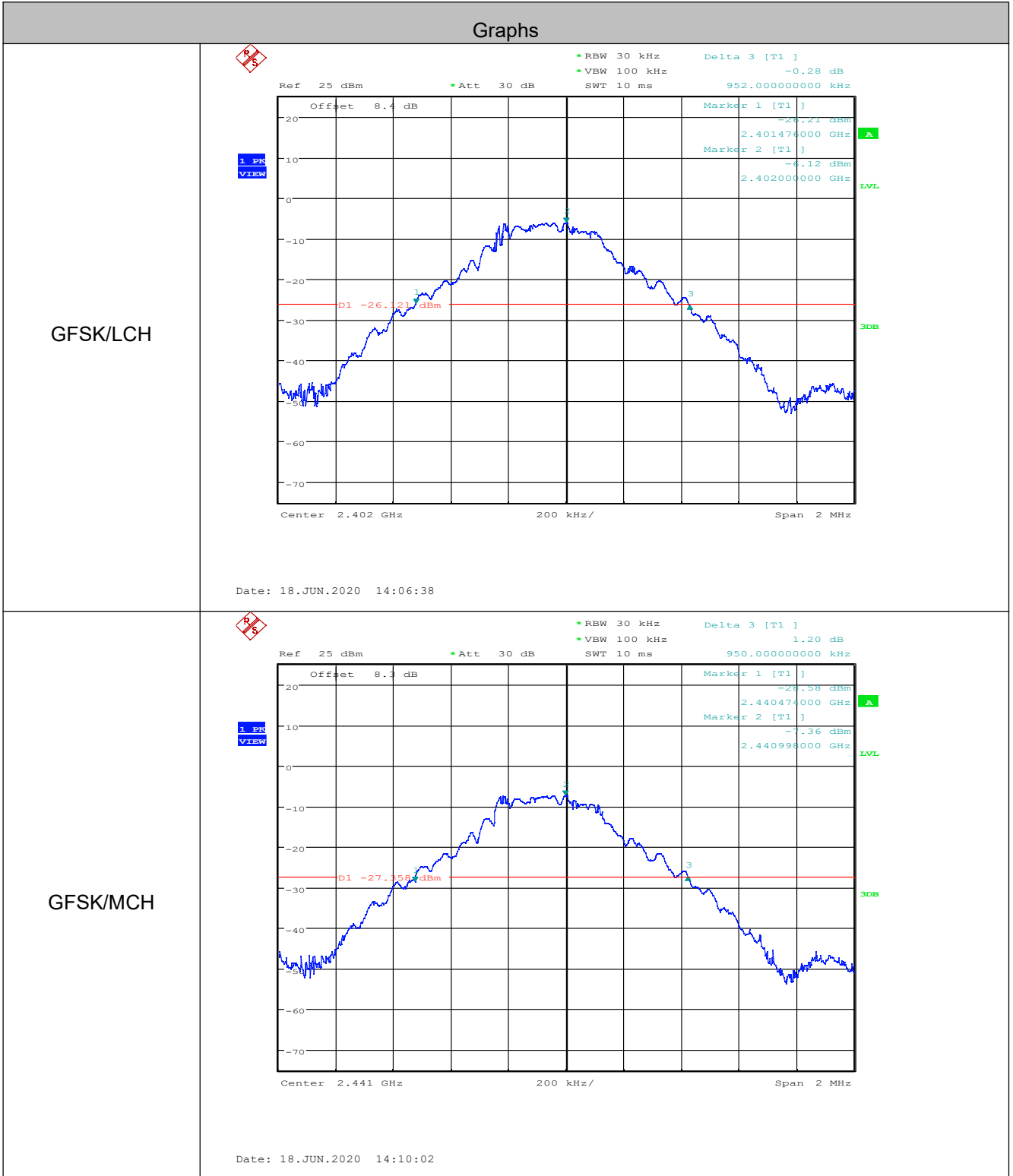

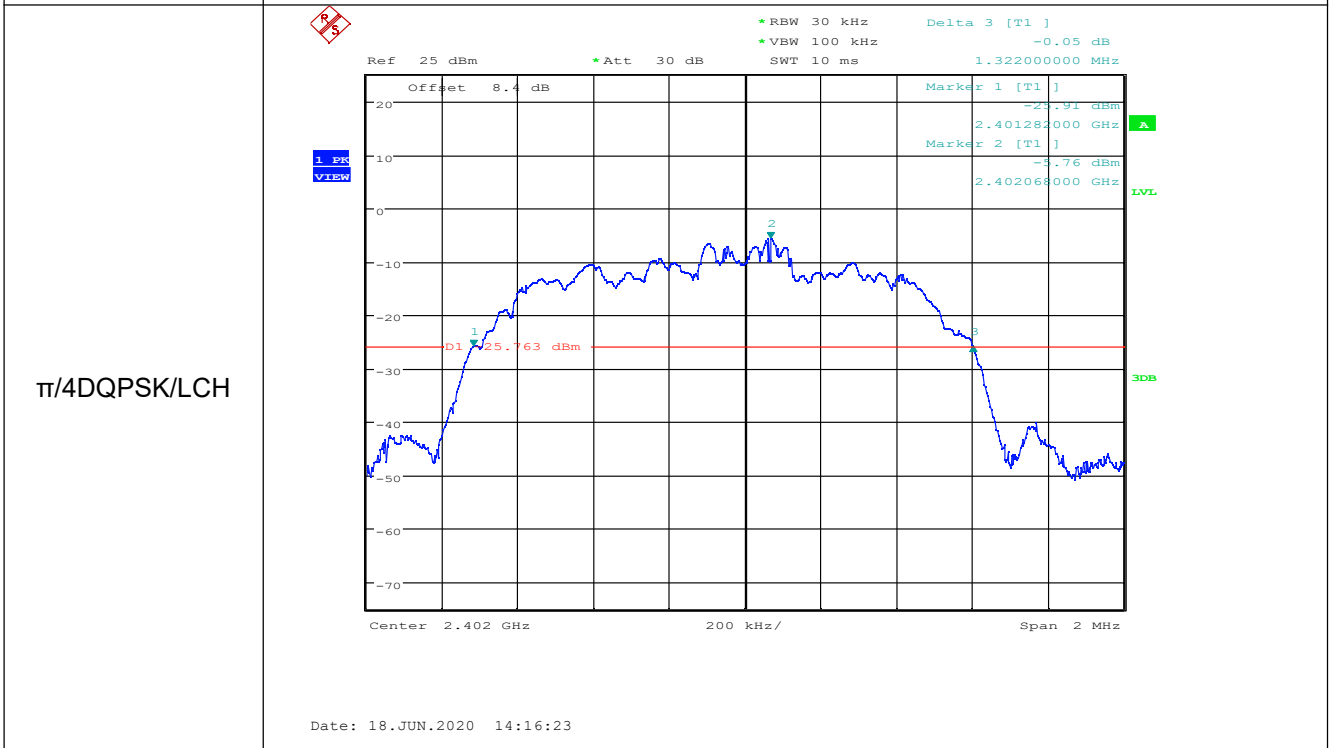

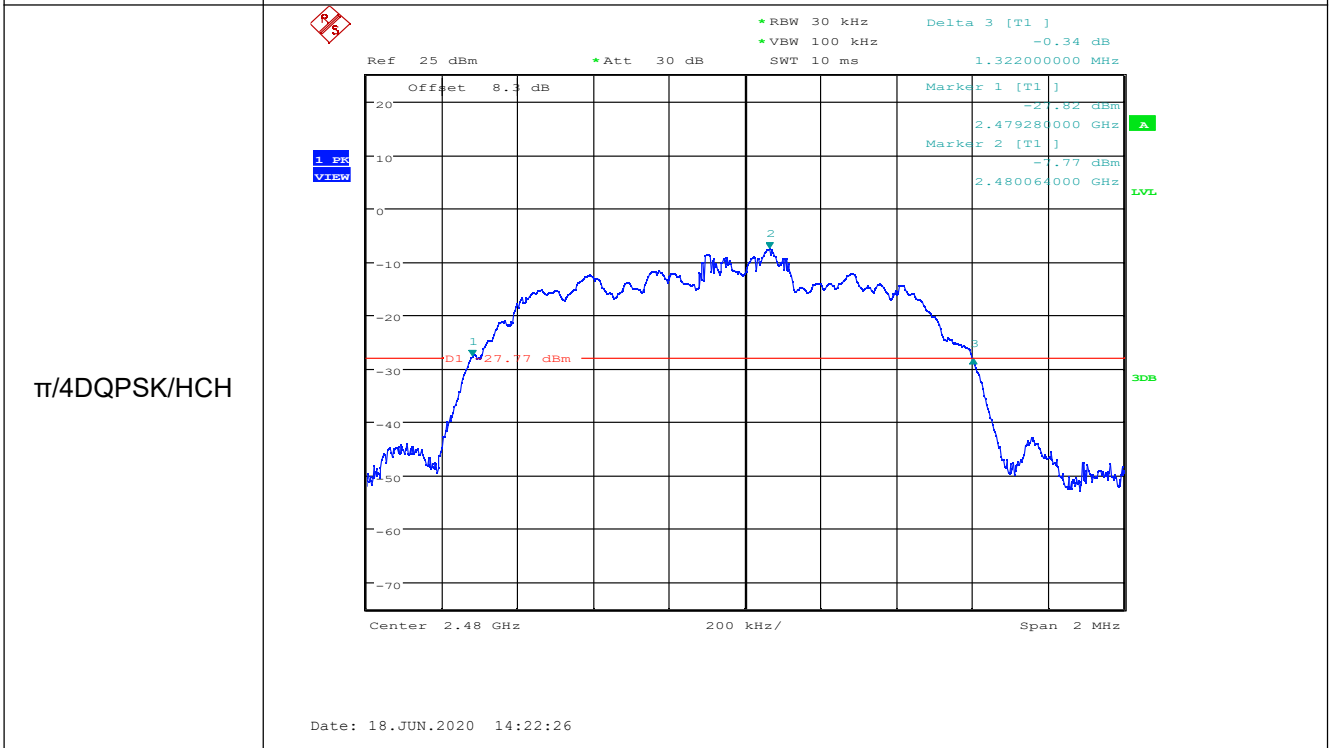
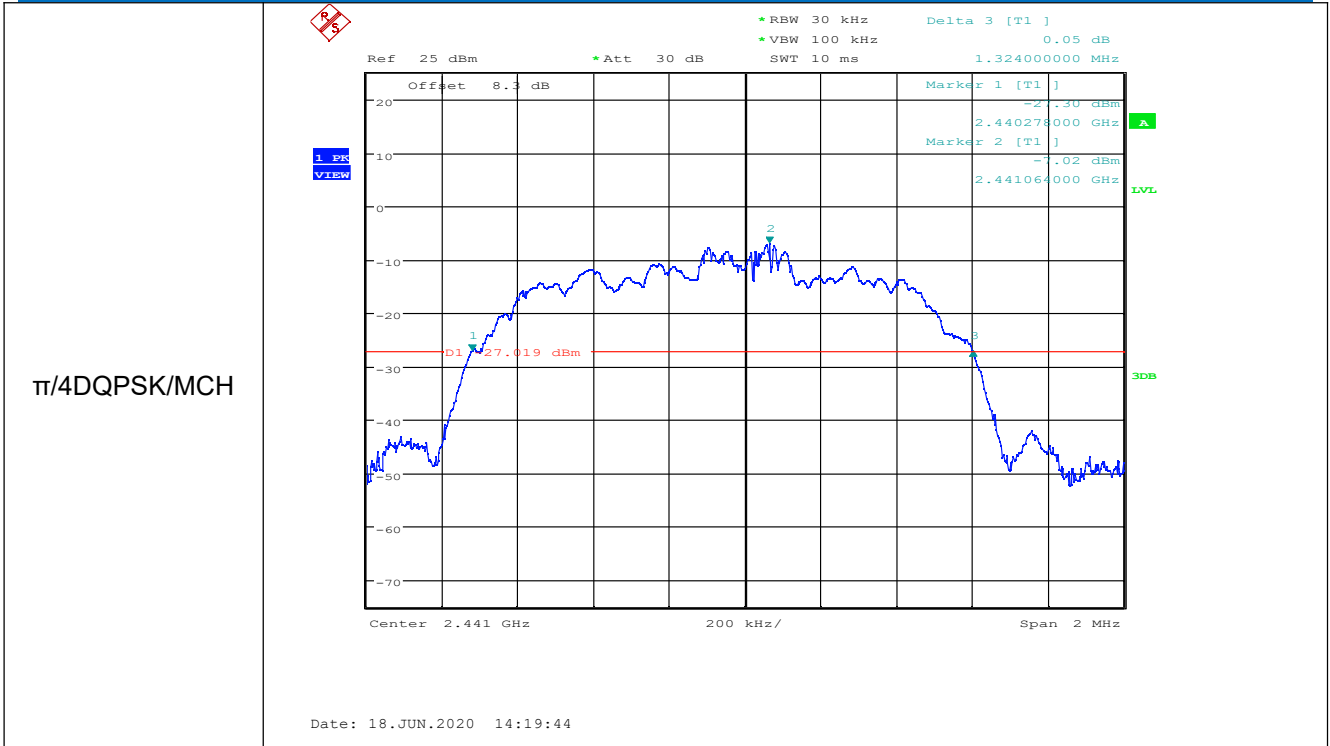

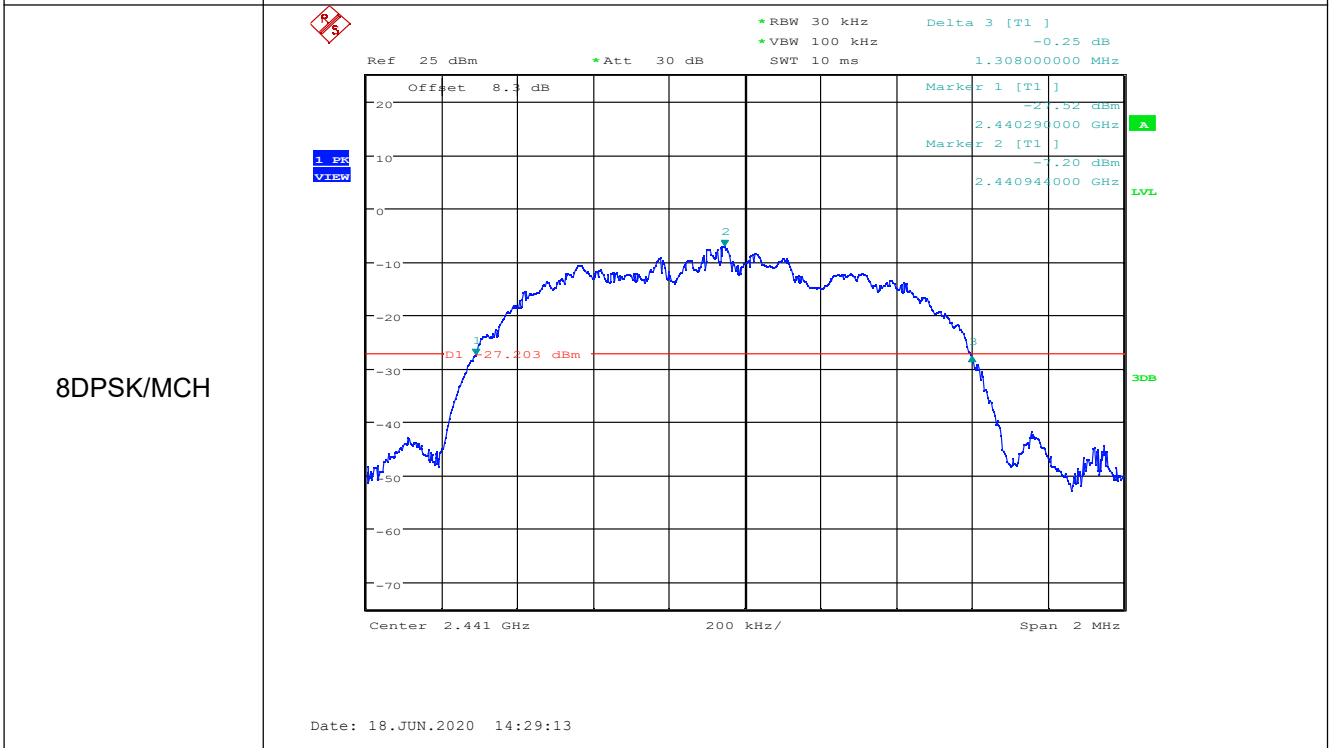
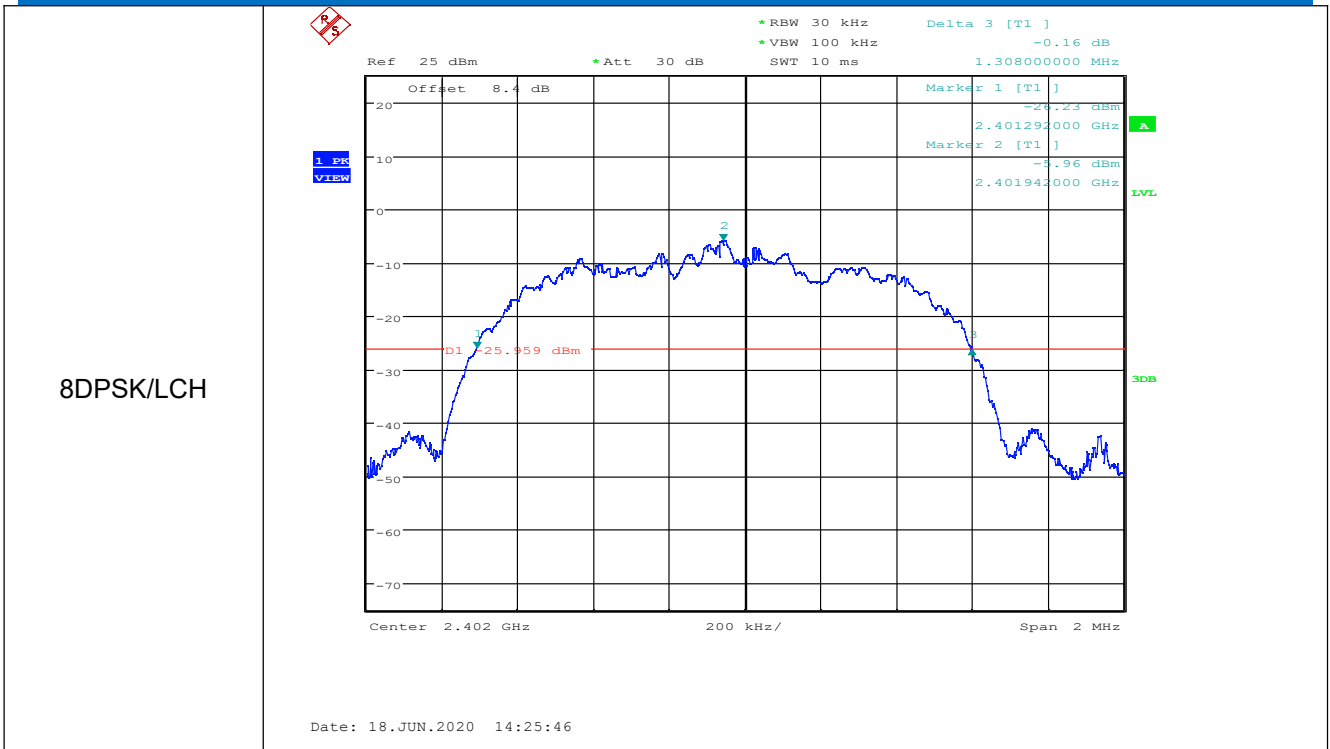

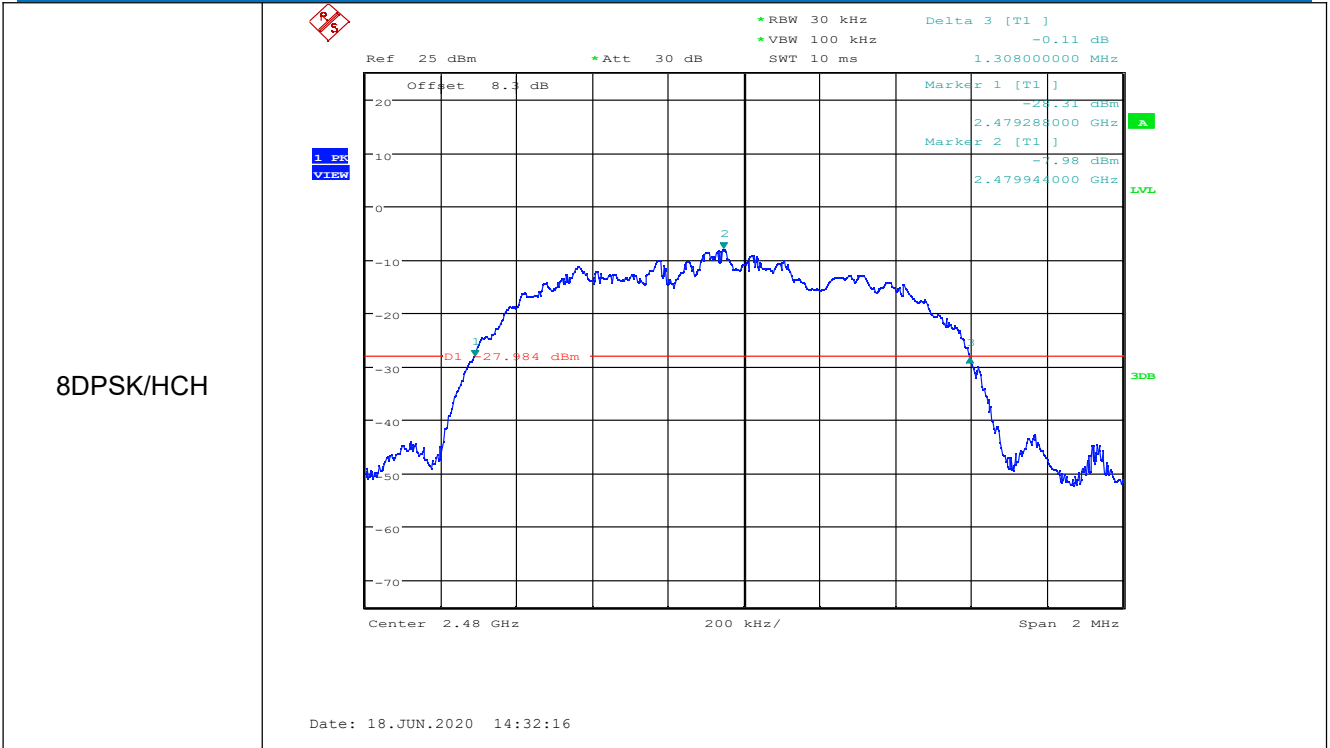

#### 4.5 Carrier Frequencies Separation

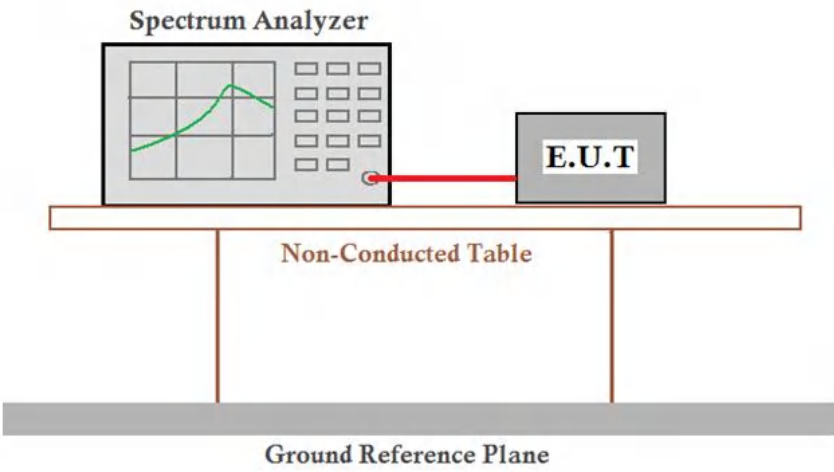
|                        |  |
|------------------------|--|
| Test Requirement:      | 47 CFR Part 15C Section 15.247 (a)(1)  |
| Test Method:           | ANSI C63.10:2013   |
| Test Setup:            |  <p>Remark: Offset=Cable loss+ attenuation factor.</p>   |
| Limit:                 | 2/3 of the 20dB bandwidth  |
|                        | Remark: the transmission power is less than 0.125W.  |
| Exploratory Test Mode: | Hopping transmitting with all kind of modulation and all kind of data type   |
| Final Test Mode:       | Through Pre-scan, find the DH5 of data type is the worst case of GFSK modulation type, 2-DH5 of data type is the worst case of $\pi/4$ DQPSK modulation type, 3-DH5 of data type is the worst case of 8DPSK modulation type.<br>Only the worst case is recorded in the report. |
| Test Results:          | Pass   |

**Measurement Data**

| GFSK mode     |                                      |             |        |
|---------------|--------------------------------------|-------------|--------|
| Test channel  | Carrier Frequencies Separation (MHz) | Limit (MHz) | Result |
| Lowest        | 1.317                                | ≥0.635      | Pass   |
| Middle        | 1.010                                | ≥0.635      | Pass   |
| Highest       | 1.313                                | ≥0.635      | Pass   |
| π/4DQPSK mode |                                      |             |        |
| Test channel  | Carrier Frequencies Separation (MHz) | Limit (MHz) | Result |
| Lowest        | 0.995                                | ≥0.883      | Pass   |
| Middle        | 1.082                                | ≥0.883      | Pass   |
| Highest       | 0.986                                | ≥0.883      | Pass   |
| 8DPSK mode    |                                      |             |        |
| Test channel  | Carrier Frequencies Separation (MHz) | Limit (MHz) | Result |
| Lowest        | 0.971                                | ≥0.872      | Pass   |
| Middle        | 1.144                                | ≥0.872      | Pass   |
| Highest       | 1.221                                | ≥0.872      | Pass   |

| Mode     | 20dB bandwidth (MHz)<br>(worse case) | Limit (MHz)<br>(Carrier Frequencies Separation) |
|----------|--------------------------------------|---|
| GFSK     | 0.952                                | 0.635   |
| π/4DQPSK | 1.324                                | 0.883   |
| 8DPSK    | 1.308                                | 0.872   |

Test plot as follows:

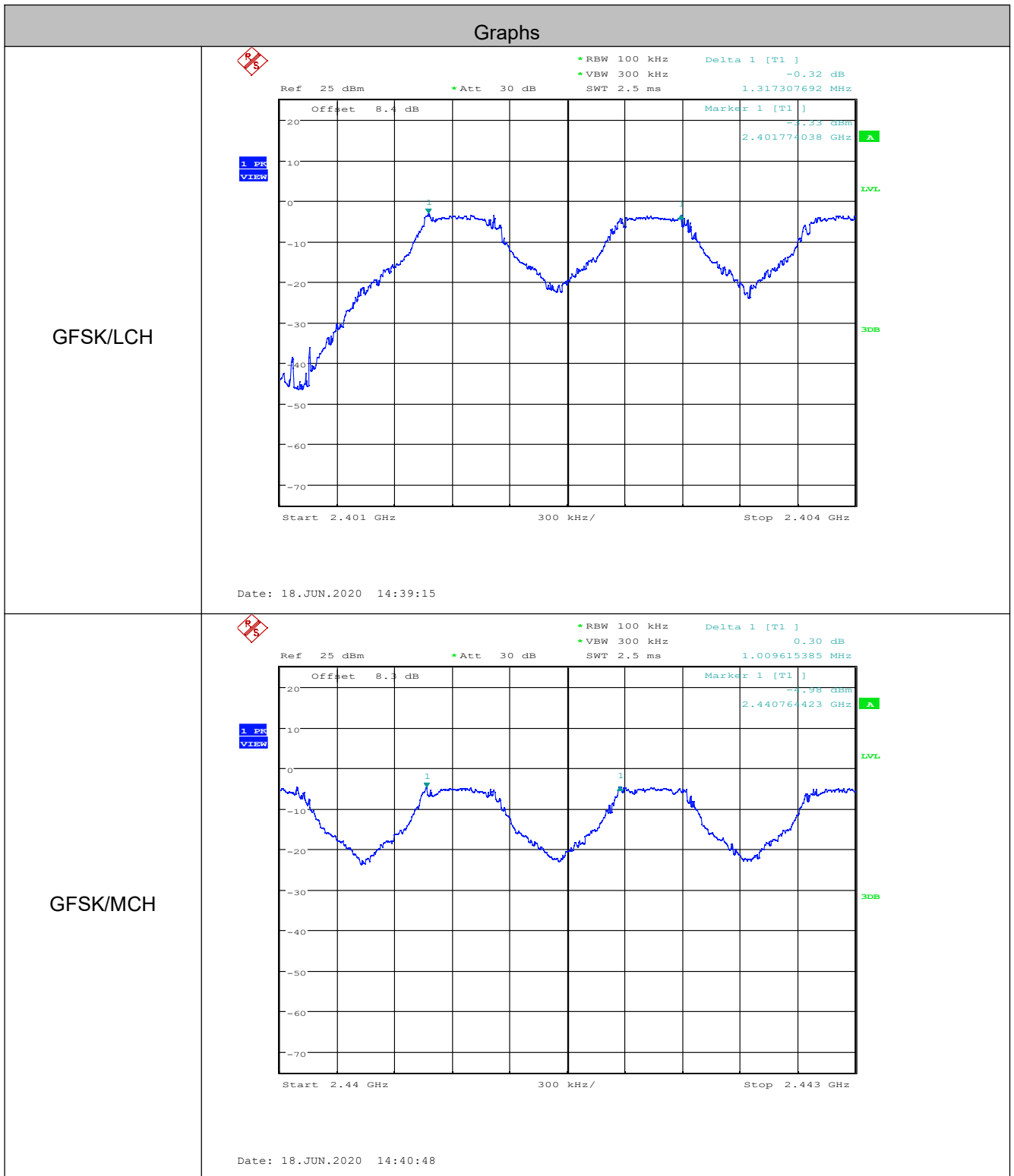



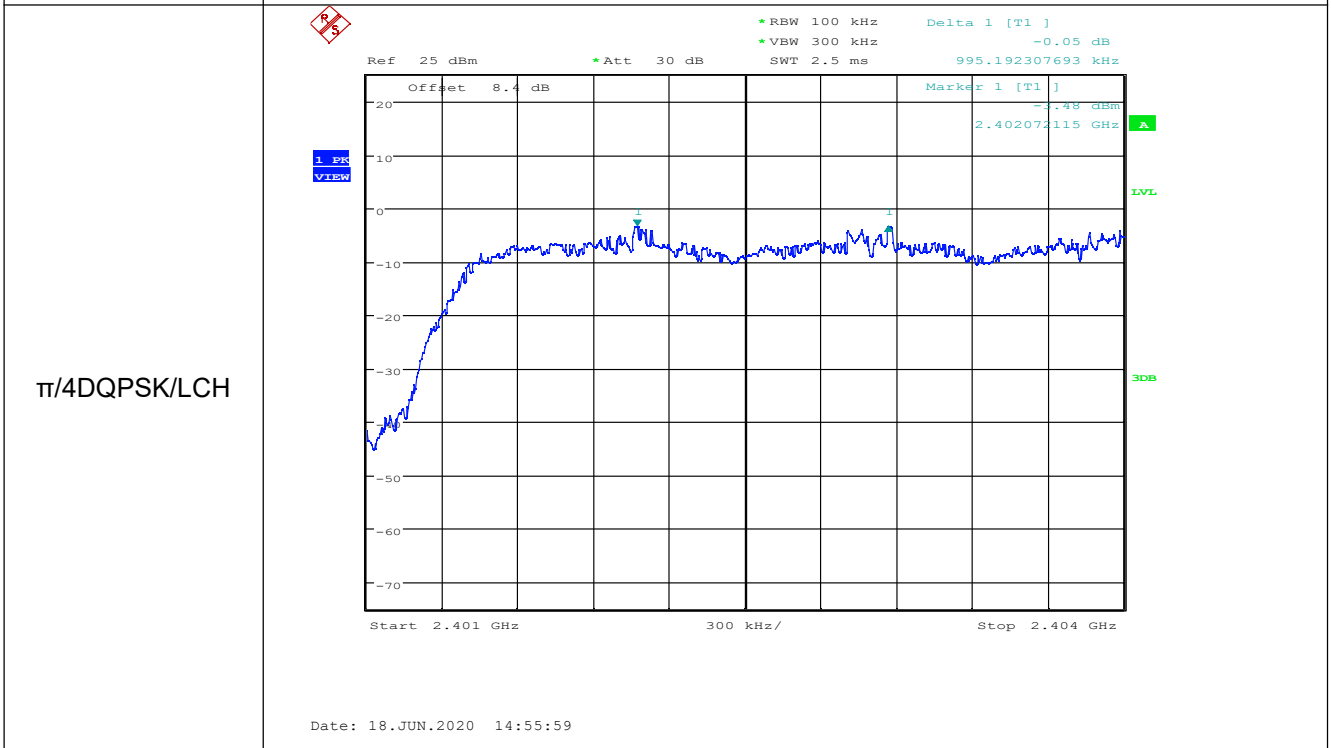
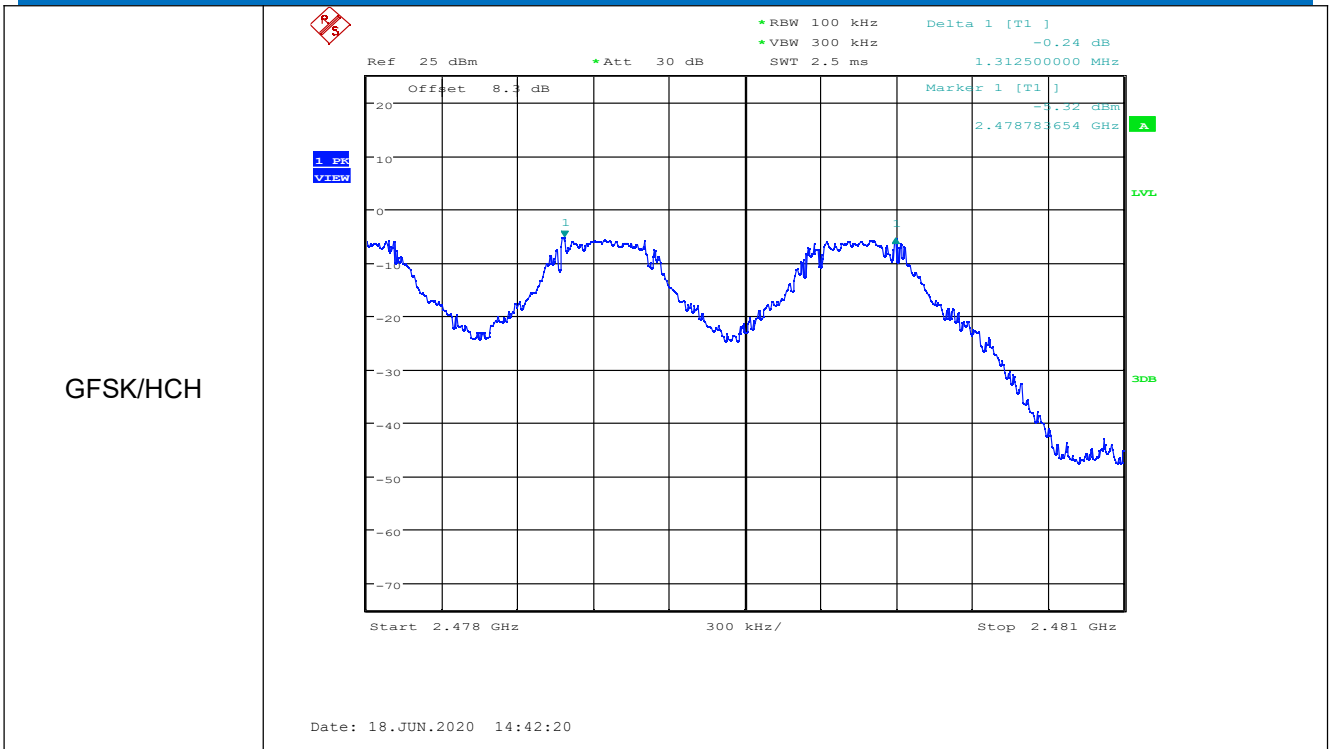

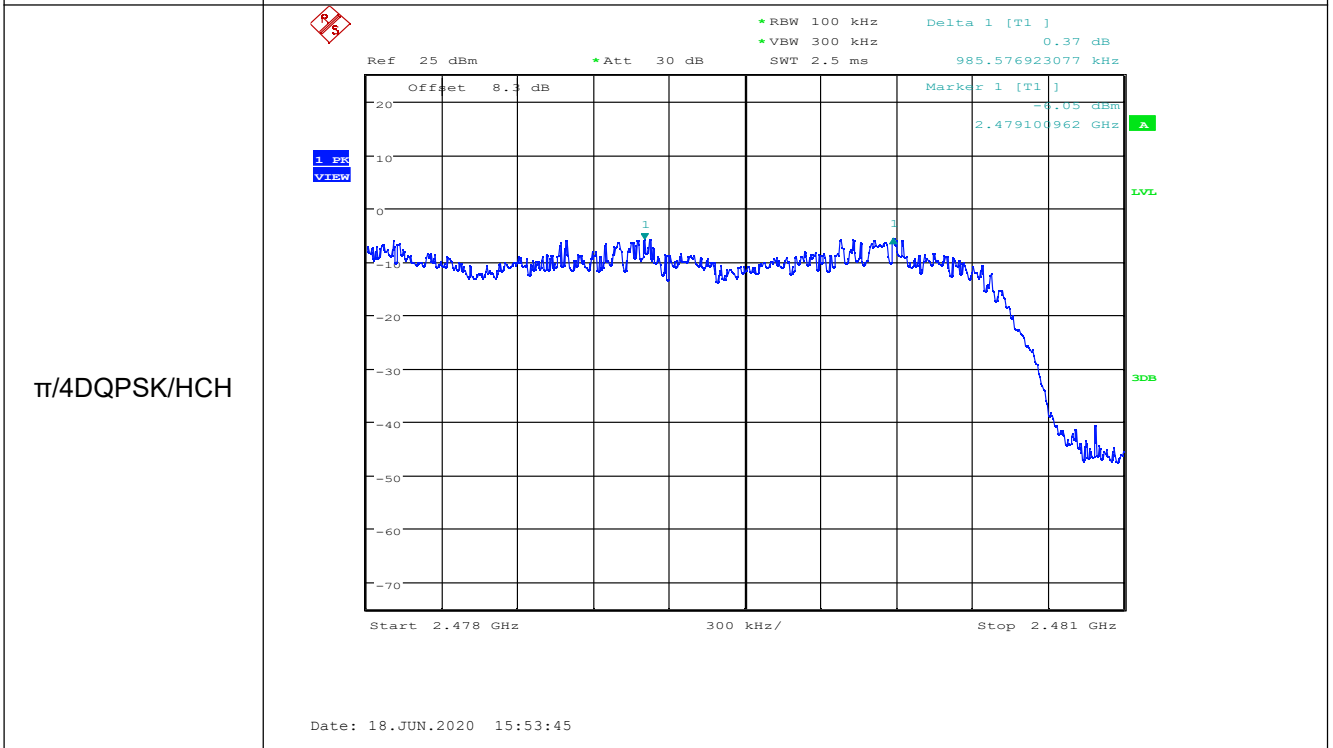
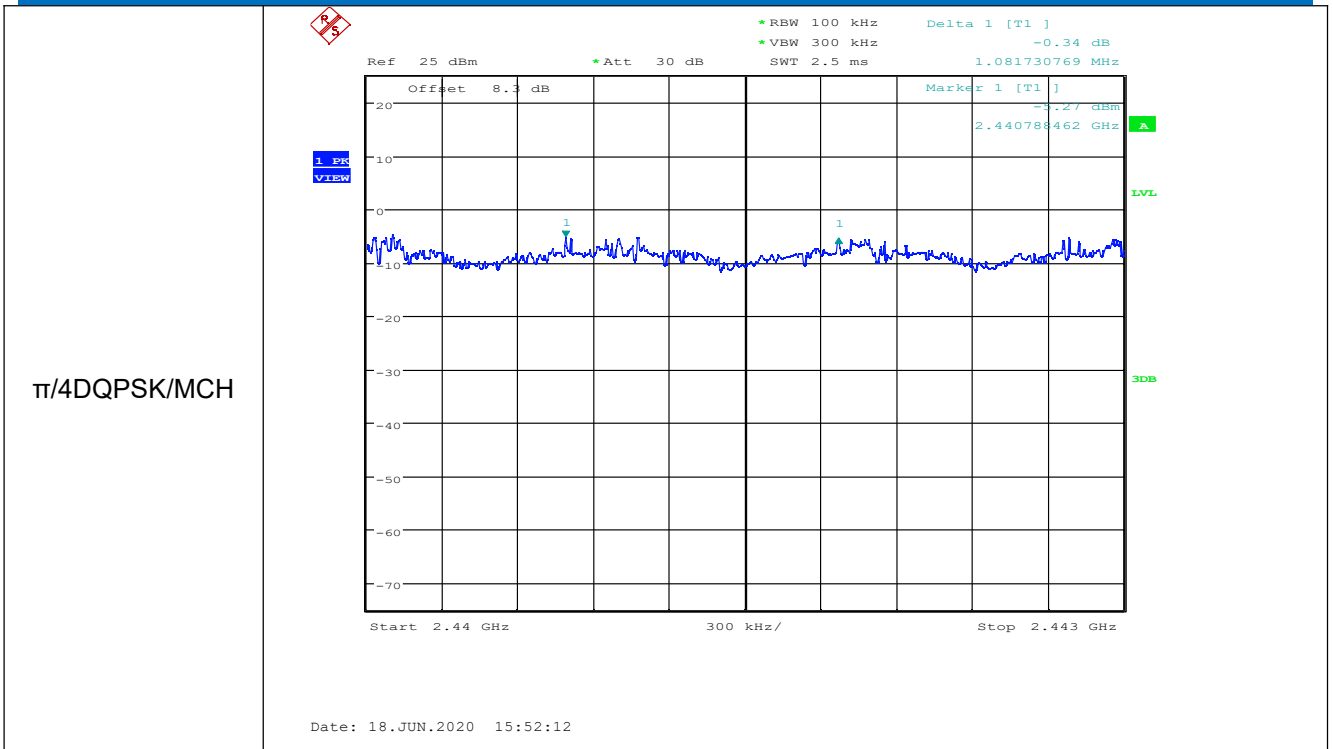

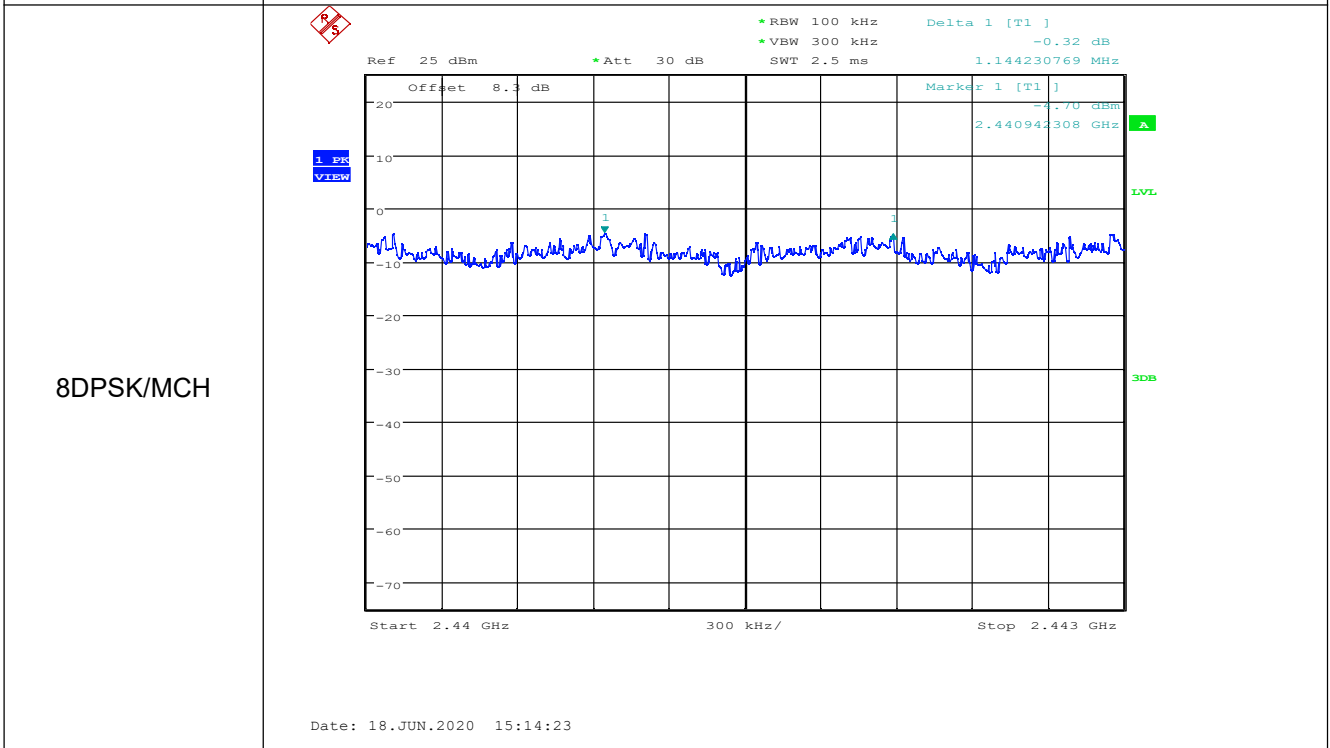
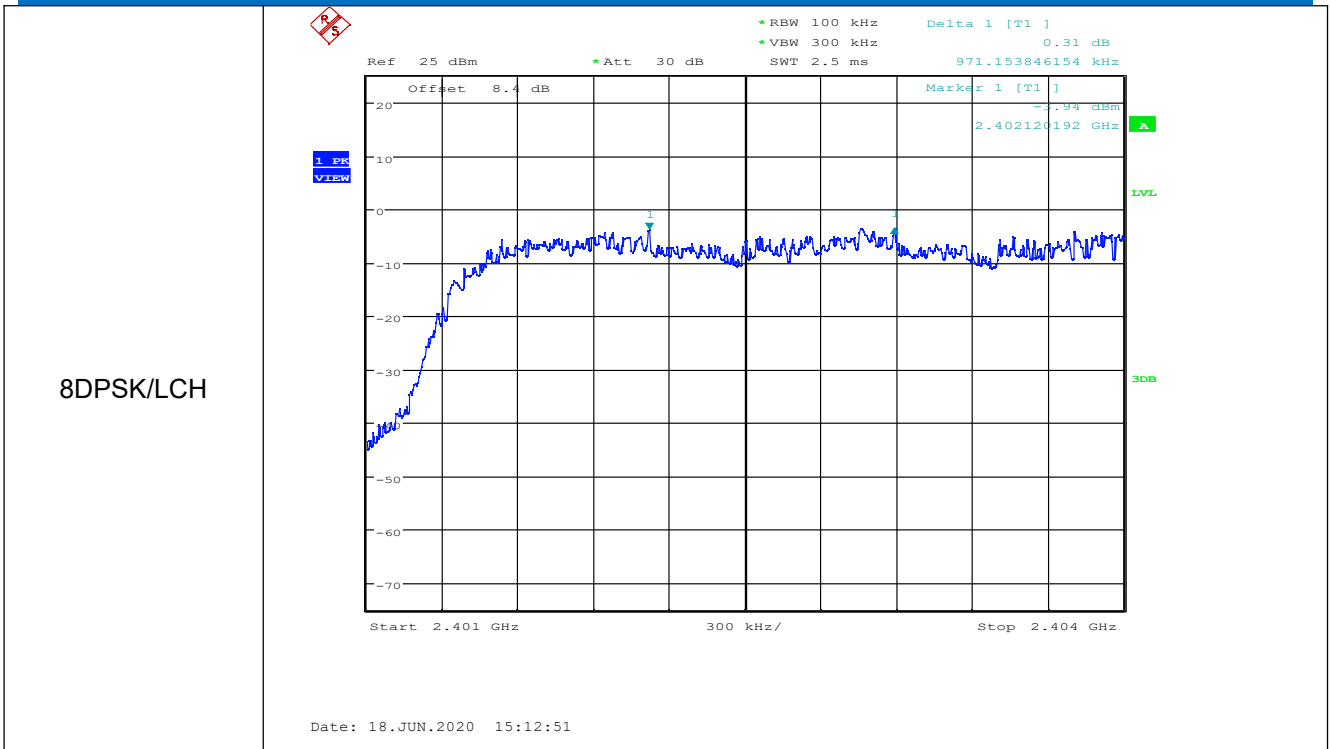

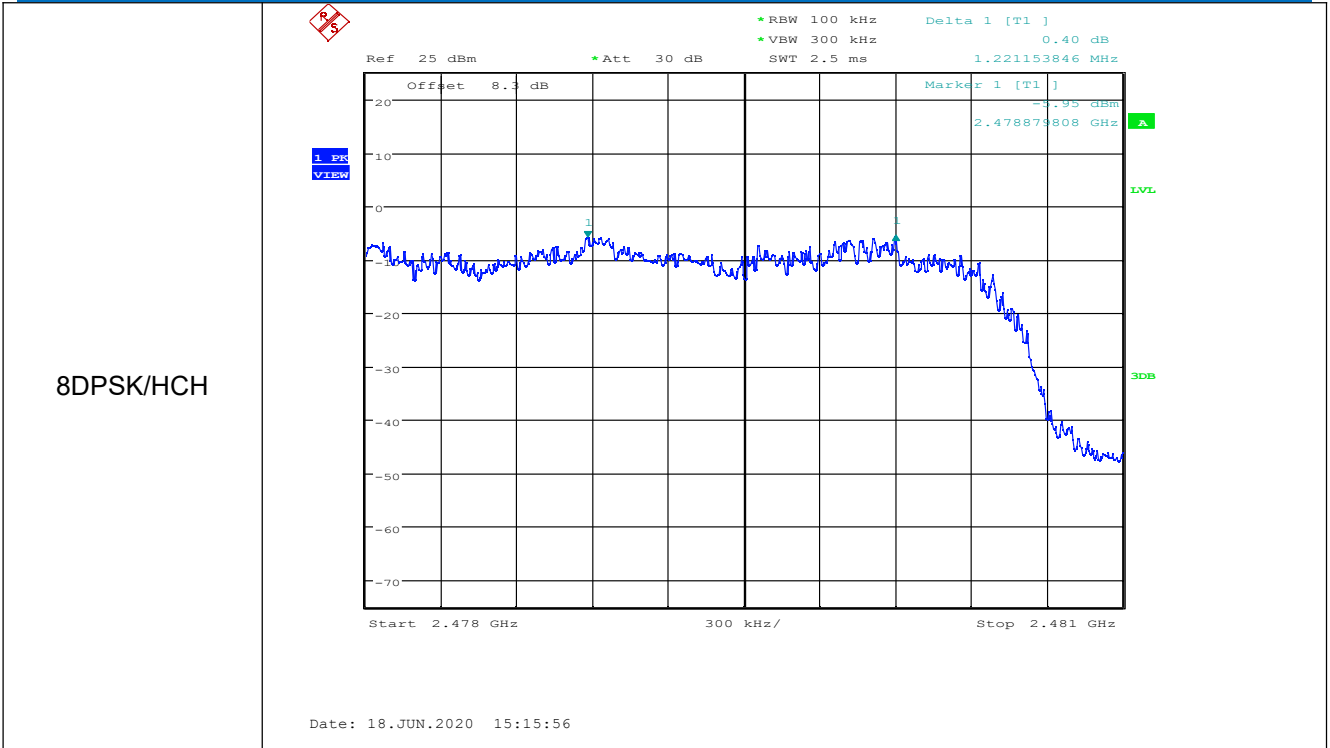

## 4.6 Hopping Channel Number

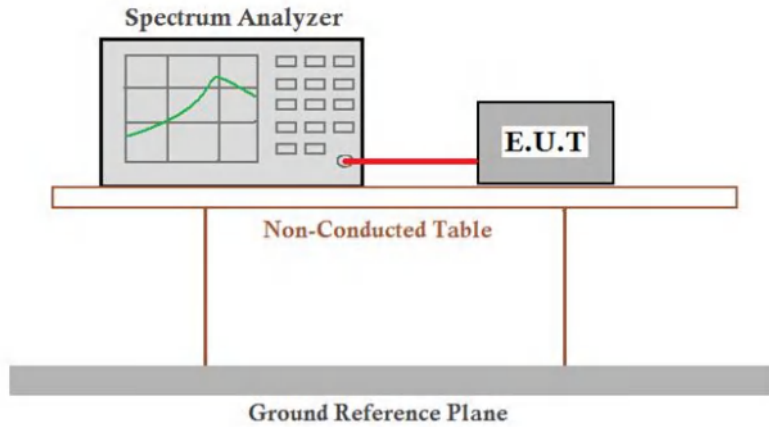
|                        |  |
|------------------------|--|
| Test Requirement:      | 47 CFR Part 15C Section 15.247 (a)(1)  |
| Test Method:           | ANSI C63.10:2013   |
| Test Setup:            |  <p style="text-align: center;"><i>Remark: Offset=Cable loss+ attenuation factor.</i></p>  |
| Limit:                 | At least 15 channels   |
| Exploratory Test Mode: | hopping transmitting with all kind of modulation and all kind of data type   |
| Final Test Mode:       | Through Pre-scan, find the DH5 of data type is the worst case of GFSK modulation type, 2-DH5 of data type is the worst case of $\pi/4$ DQPSK modulation type, 3-DH5 of data type is the worst case of 8DPSK modulation type.<br>Only the worst case is recorded in the report. |
| Test Results:          | Pass   |

### Measurement Data

| Mode          | Hopping channel numbers | Limit     |
|---------------|-------------------------|-----------|
| GFSK          | 79                      | $\geq 15$ |
| $\pi/4$ DQPSK | 79                      | $\geq 15$ |
| 8DPSK         | 79                      | $\geq 15$ |

Test plot as follows:

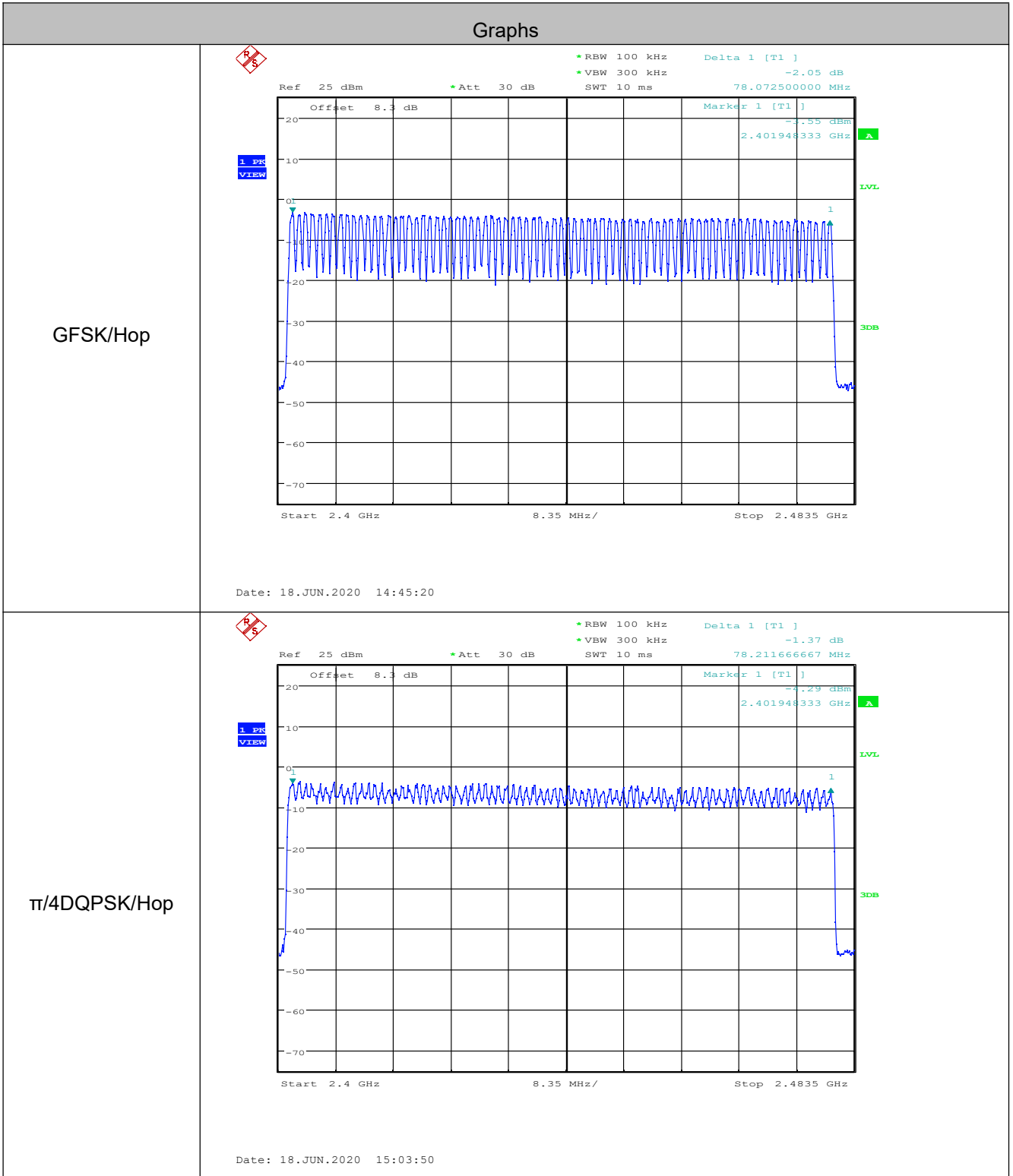

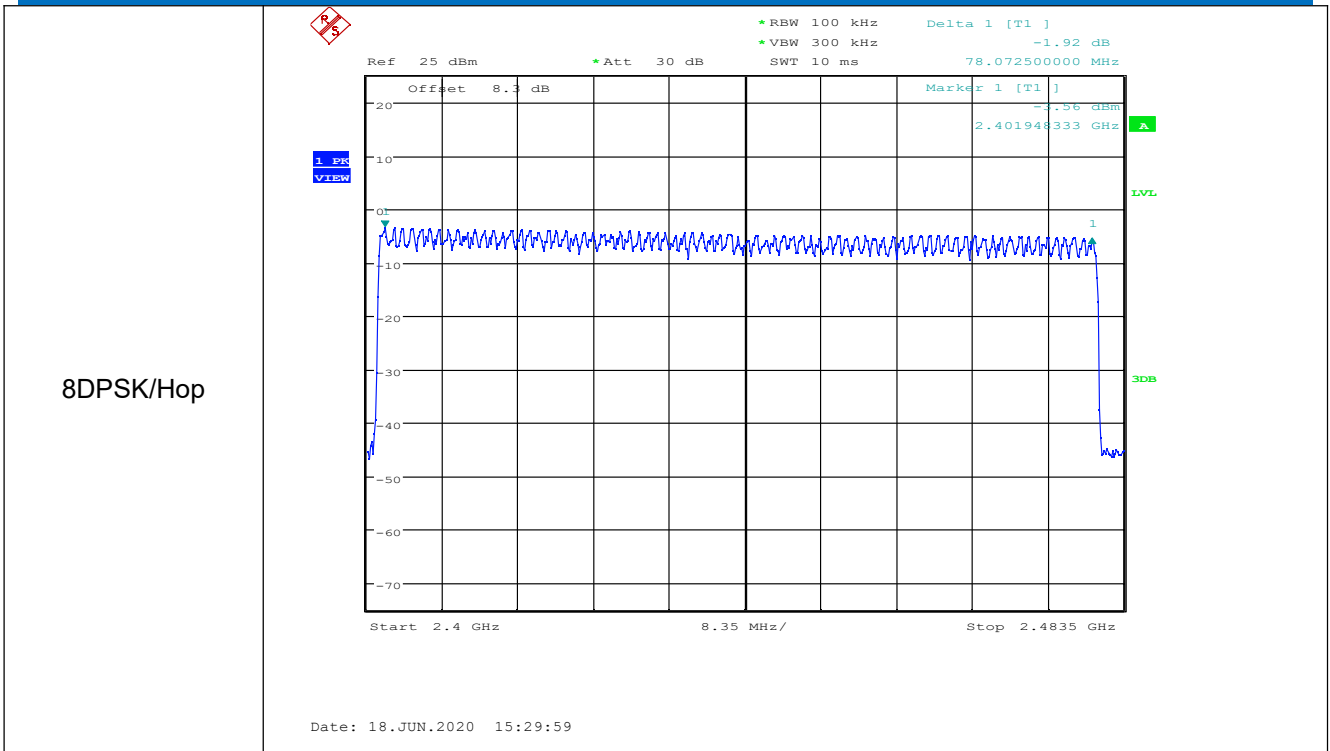

#### 4.7 Dwell Time

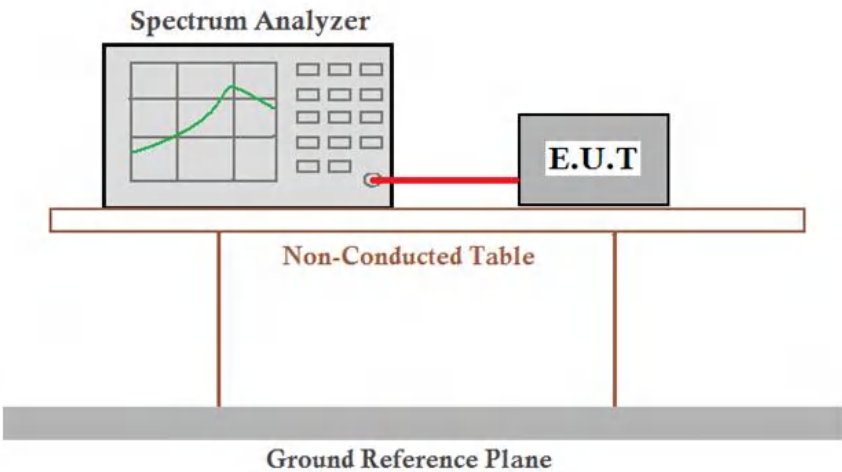
|                   |   |
|-------------------|---|
| Test Requirement: | 47 CFR Part 15C Section 15.247 (a)(1)   |
| Test Method:      | ANSI C63.10:2013  |
| Test Setup:       |  <p style="text-align: center;"><i>Remark: Offset=Cable loss+ attenuation factor.</i></p> |
| Test Mode:        | Hopping transmitting with all kind of modulation and all kind of data type.   |
| Limit:            | 0.4 Second  |
| Test Results:     | Pass  |



Measurement Data

| Mode     | Packet | Channel | Burst Width<br>[ms/hop/ch] | Dwell Time[s] | Limit (second) |
|----------|--------|---------|----------------------------|---------------|----------------|
| GFSK     | DH1    | LCH     | 0.4                        | 0.128         | ≤0.4           |
| GFSK     | DH1    | MCH     | 0.4                        | 0.128         | ≤0.4           |
| GFSK     | DH1    | HCH     | 0.4                        | 0.128         | ≤0.4           |
| π/4DQPSK | 2DH1   | LCH     | 0.4                        | 0.128         | ≤0.4           |
| π/4DQPSK | 2DH1   | MCH     | 0.4                        | 0.128         | ≤0.4           |
| π/4DQPSK | 2DH1   | HCH     | 0.41                       | 0.131         | ≤0.4           |
| 8DPSK    | 3DH1   | LCH     | 0.41                       | 0.131         | ≤0.4           |
| 8DPSK    | 3DH1   | MCH     | 0.41                       | 0.131         | ≤0.4           |
| 8DPSK    | 3DH1   | HCH     | 0.41                       | 0.131         | ≤0.4           |
| GFSK     | DH3    | LCH     | 1.65                       | 0.264         | ≤0.4           |
| GFSK     | DH3    | MCH     | 1.65                       | 0.264         | ≤0.4           |
| GFSK     | DH3    | HCH     | 1.65                       | 0.264         | ≤0.4           |
| π/4DQPSK | 2DH3   | LCH     | 1.66                       | 0.266         | ≤0.4           |
| π/4DQPSK | 2DH3   | MCH     | 1.66                       | 0.266         | ≤0.4           |
| π/4DQPSK | 2DH3   | HCH     | 1.66                       | 0.266         | ≤0.4           |
| 8DPSK    | 3DH3   | LCH     | 1.65                       | 0.264         | ≤0.4           |
| 8DPSK    | 3DH3   | MCH     | 1.66                       | 0.266         | ≤0.4           |
| 8DPSK    | 3DH3   | HCH     | 1.66                       | 0.266         | ≤0.4           |
| GFSK     | DH5    | LCH     | 2.9                        | 0.309         | ≤0.4           |
| GFSK     | DH5    | MCH     | 2.9                        | 0.309         | ≤0.4           |
| GFSK     | DH5    | HCH     | 2.9                        | 0.309         | ≤0.4           |
| π/4DQPSK | 2DH5   | LCH     | 2.9                        | 0.309         | ≤0.4           |
| π/4DQPSK | 2DH5   | MCH     | 2.9                        | 0.309         | ≤0.4           |
| π/4DQPSK | 2DH5   | HCH     | 2.9                        | 0.309         | ≤0.4           |
| 8DPSK    | 3DH5   | LCH     | 2.9                        | 0.309         | ≤0.4           |
| 8DPSK    | 3DH5   | MCH     | 2.9                        | 0.309         | ≤0.4           |
| 8DPSK    | 3DH5   | HCH     | 2.9                        | 0.309         | ≤0.4           |

Remark:

The test period:  $T = 0.4 \text{ Second/Channel} \times 79 \text{ Channel} = 31.6 \text{ s}$

DH1/2DH1/3DH1 Dwell time = Burst Width(ms)\*(1600/ (2\*79))\*31.6

DH3/2DH3/3DH3 Dwell time = Burst Width (ms)\*(1600/ (4\*79))\*31.6

DH5/2DH5/3DH5 Dwell time = Burst Width (ms)\*(1600/ (6\*79))\*31.6

Test plot as follows:

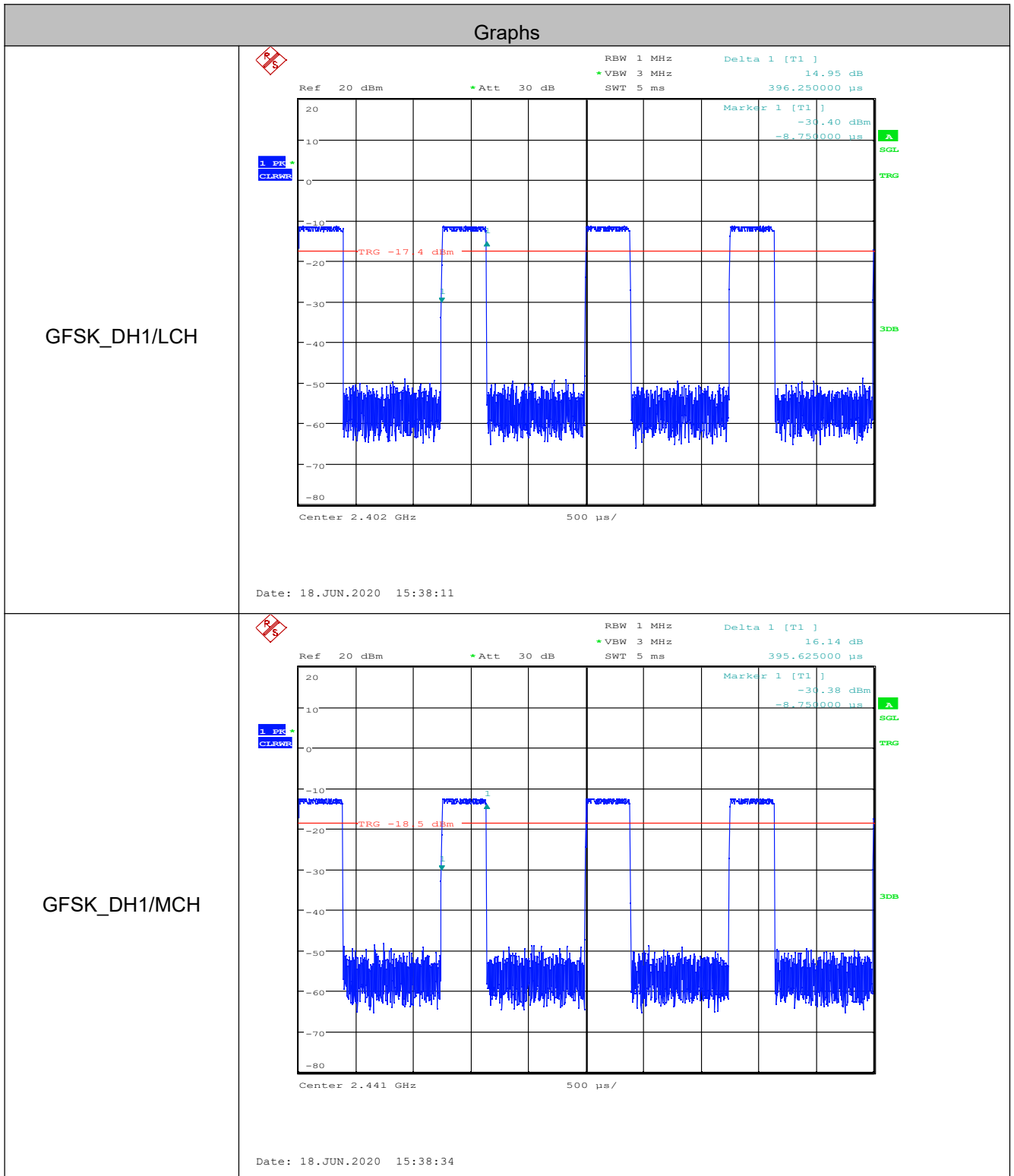

GFSK\_DH1/HCH

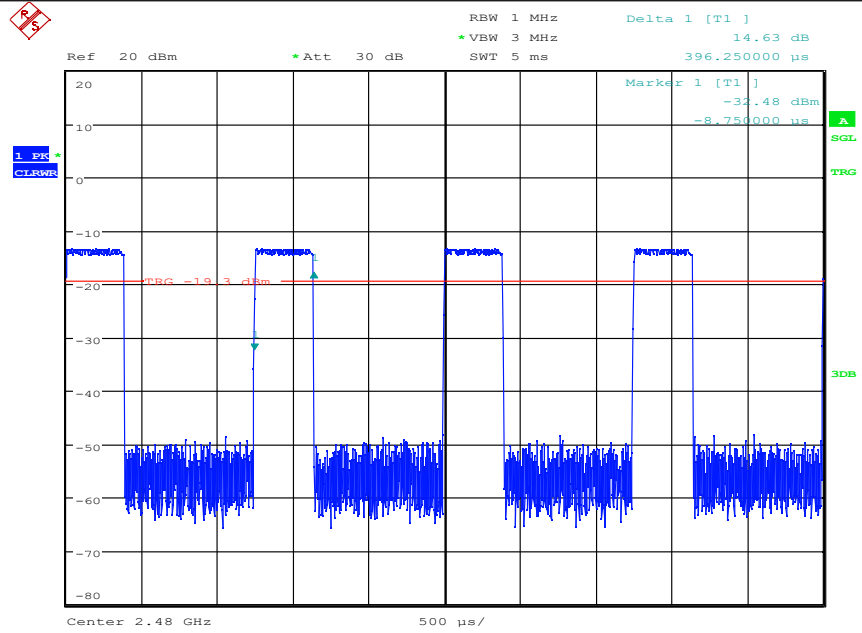

Date: 18.JUN.2020 15:38:57

$\pi/4$ DQPSK  
\_2DH1/LCH

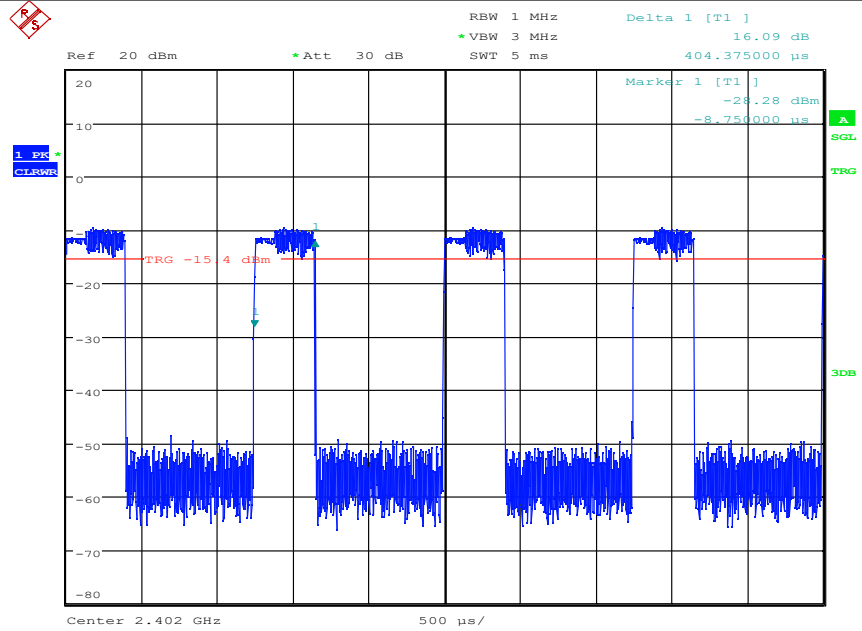

Date: 18.JUN.2020 15:42:04

$\pi/4$ DQPSK  
\_2DH1/MCH

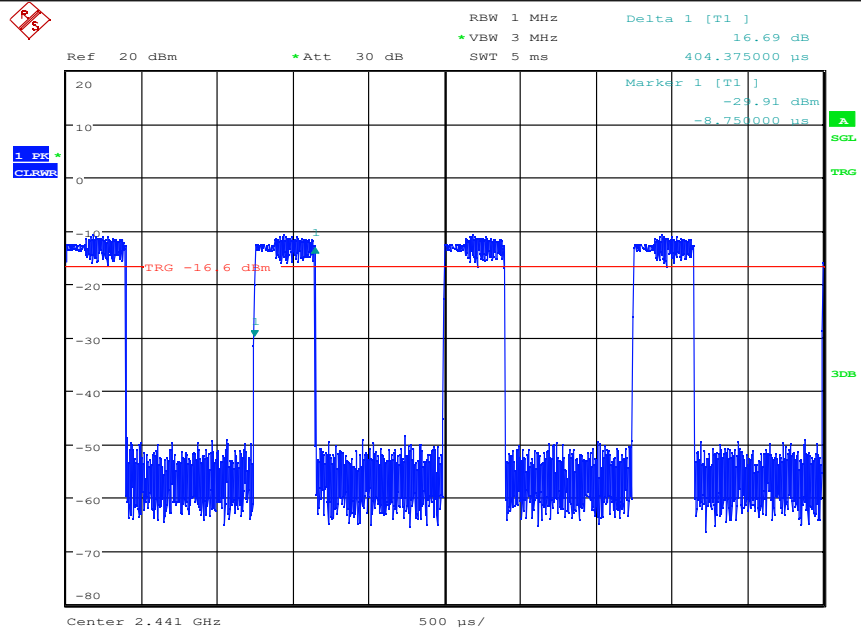

Date: 18.JUN.2020 15:42:28

$\pi/4$ DQPSK  
\_2DH1/HCH

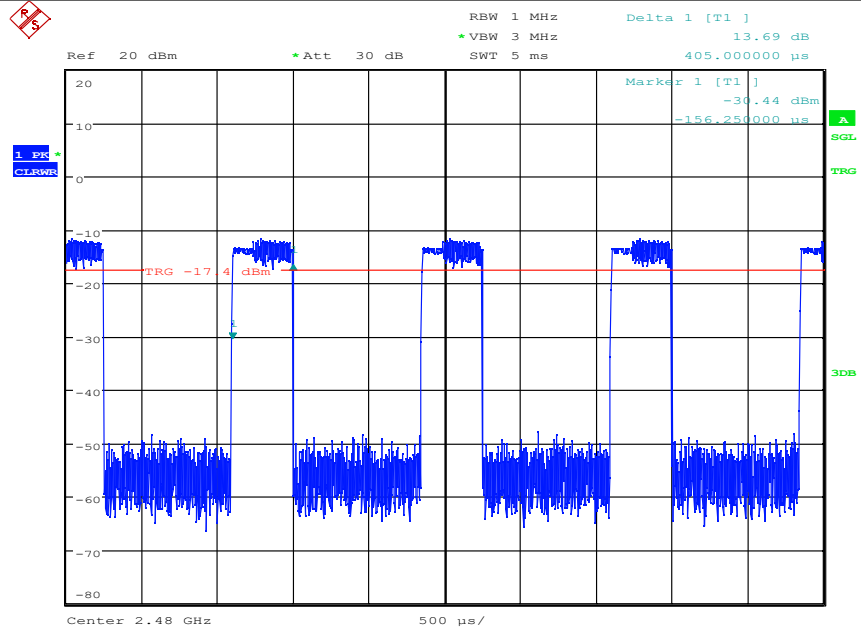

Date: 18.JUN.2020 15:42:53

8DPSK\_3DH1/LCH

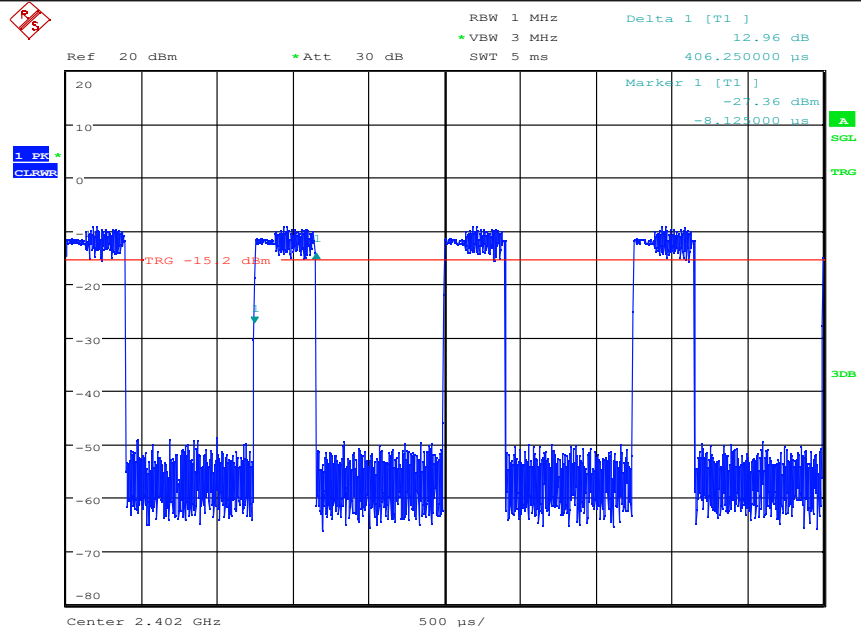

Date: 18.JUN.2020 15:45:47

8DPSK\_3DH1/MCH

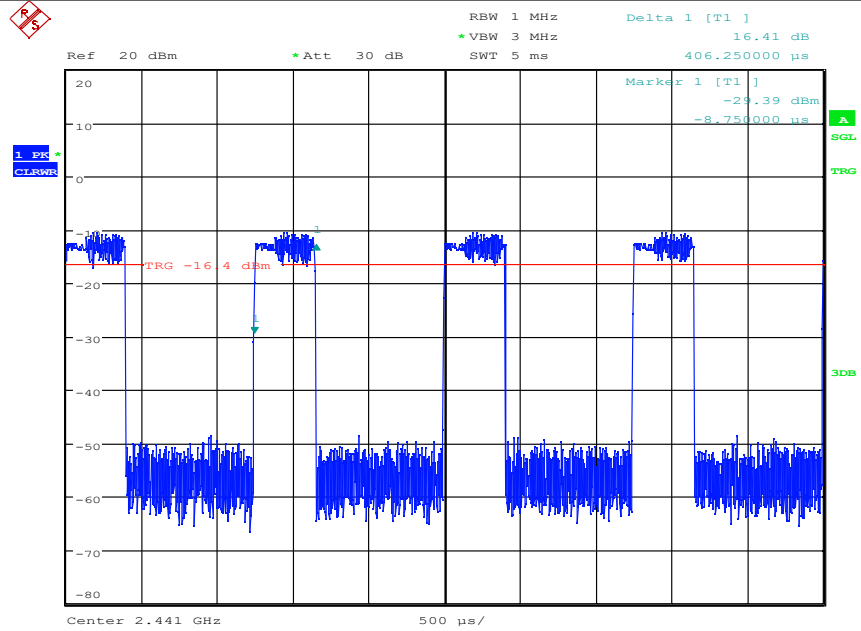

Date: 18.JUN.2020 15:46:11

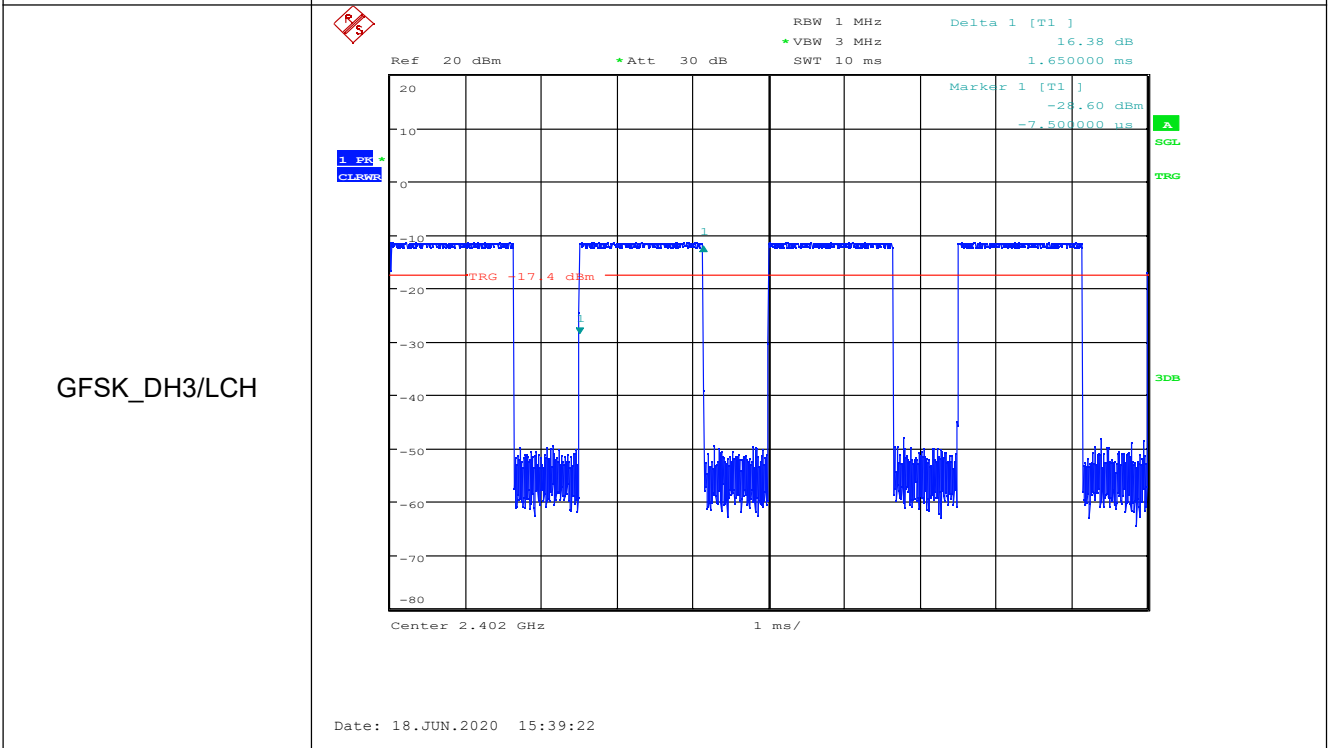
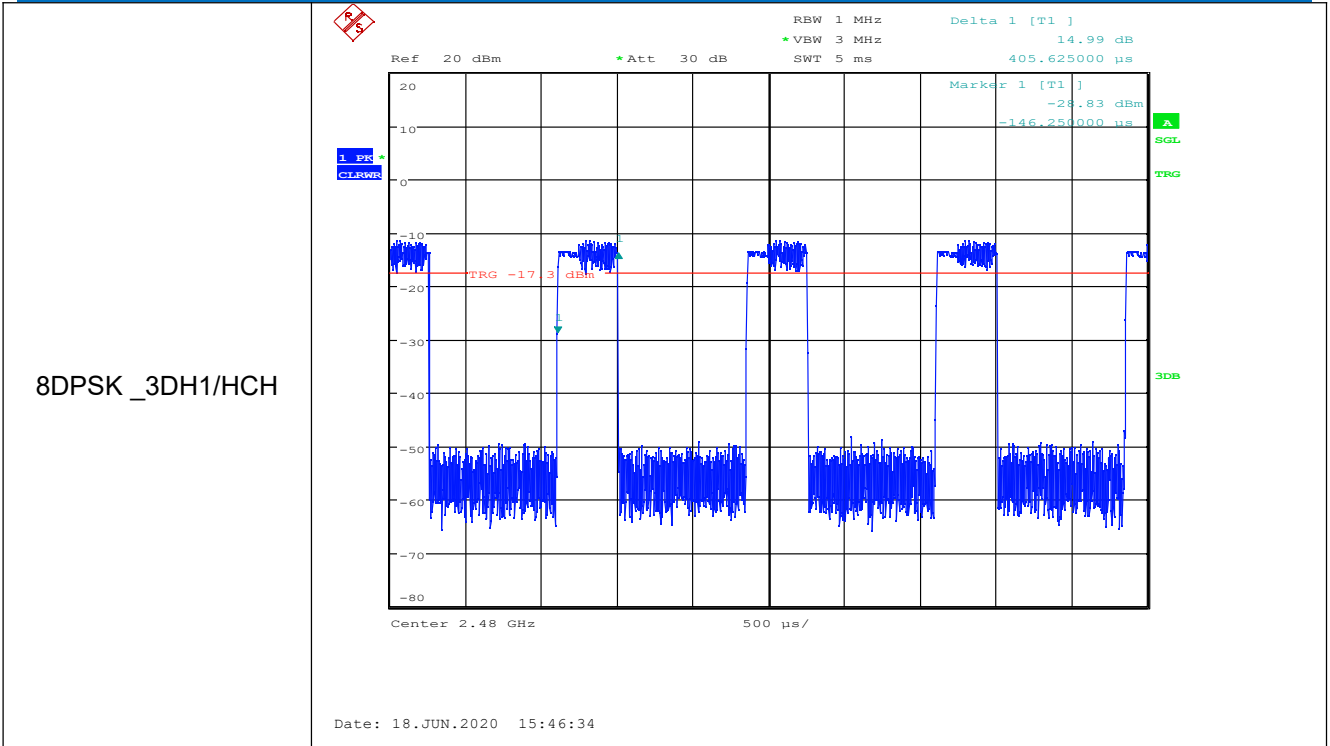

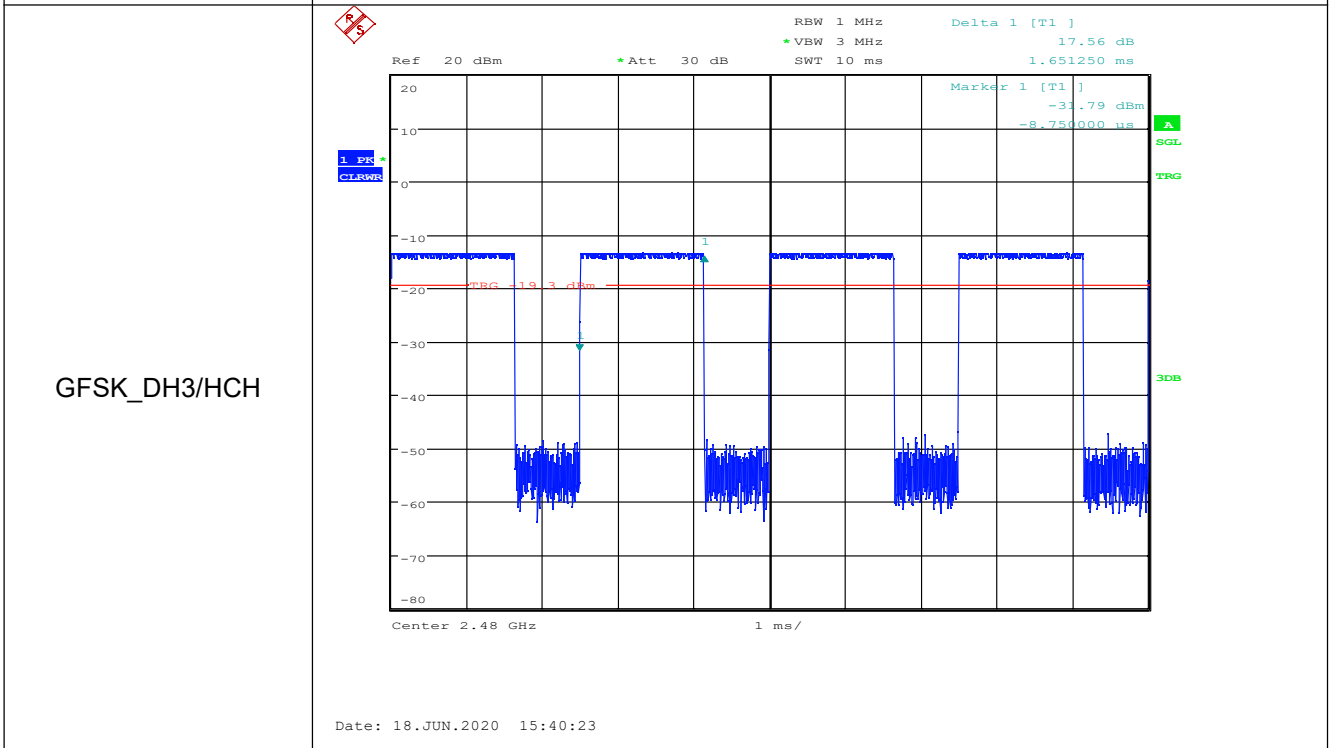
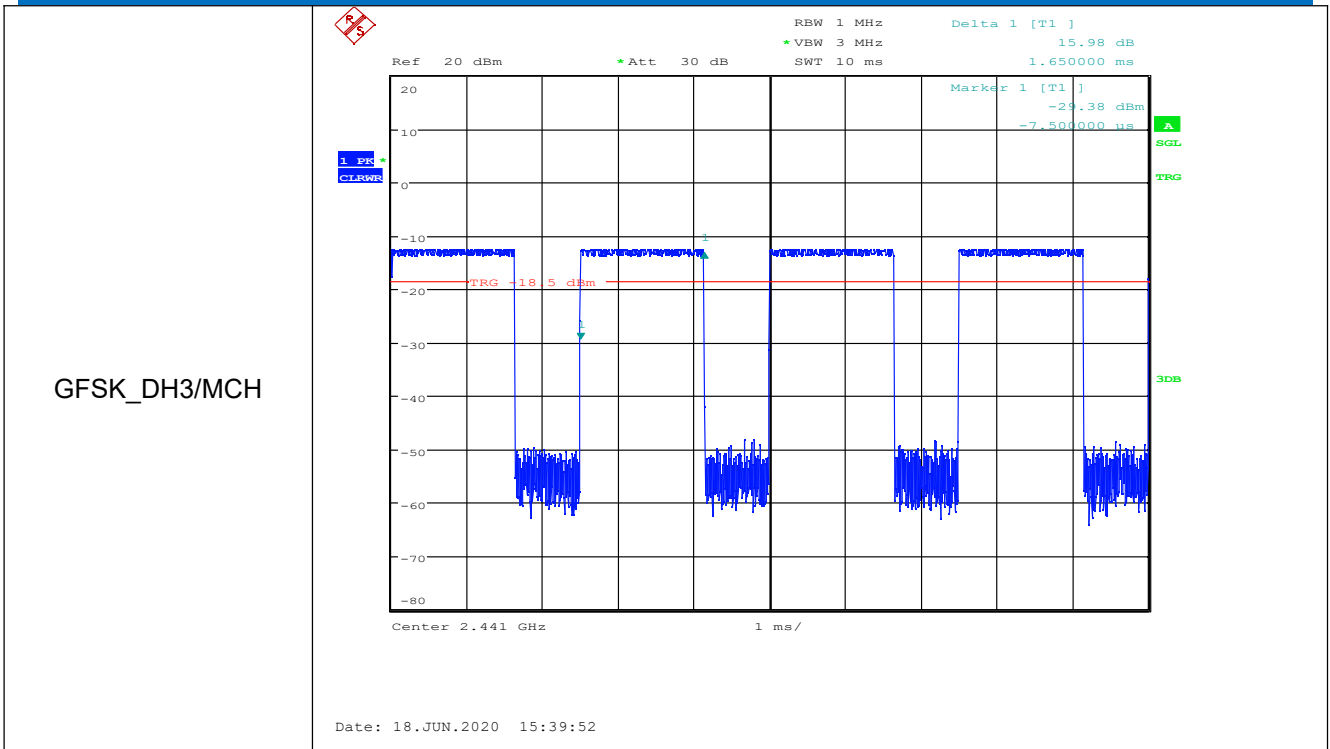

$\pi/4$ DQPSK  
\_2DH3/LCH

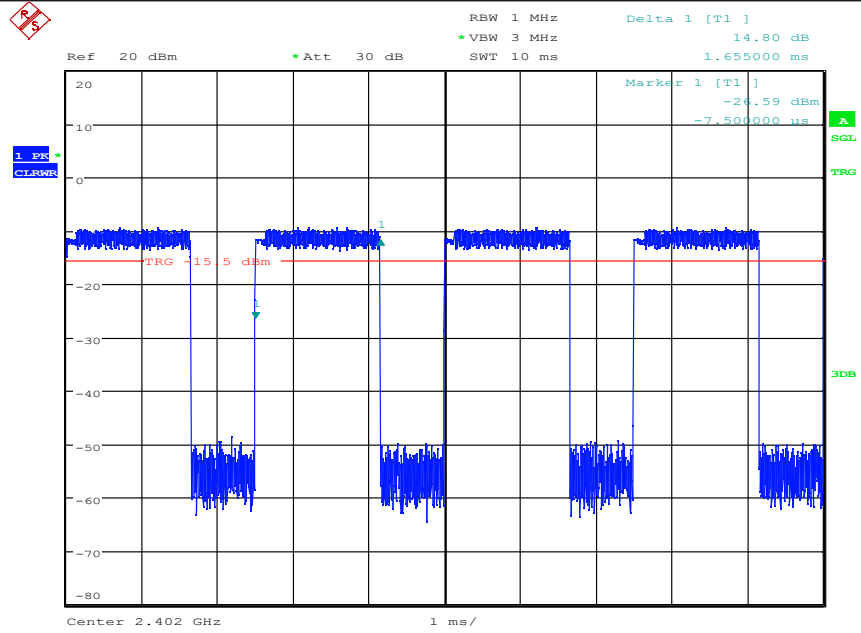

Date: 18.JUN.2020 15:43:16

$\pi/4$ DQPSK  
\_2DH3/MCH

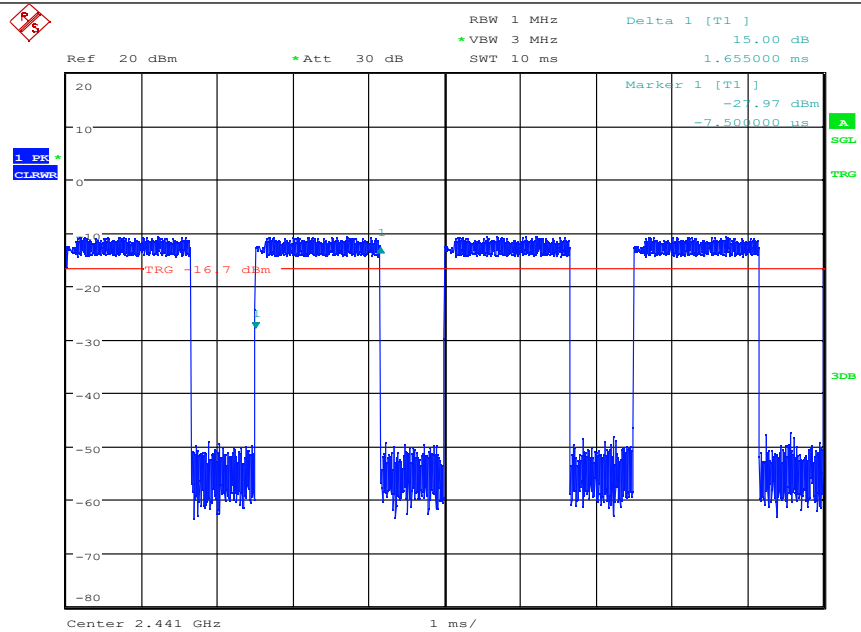

Date: 18.JUN.2020 15:43:40



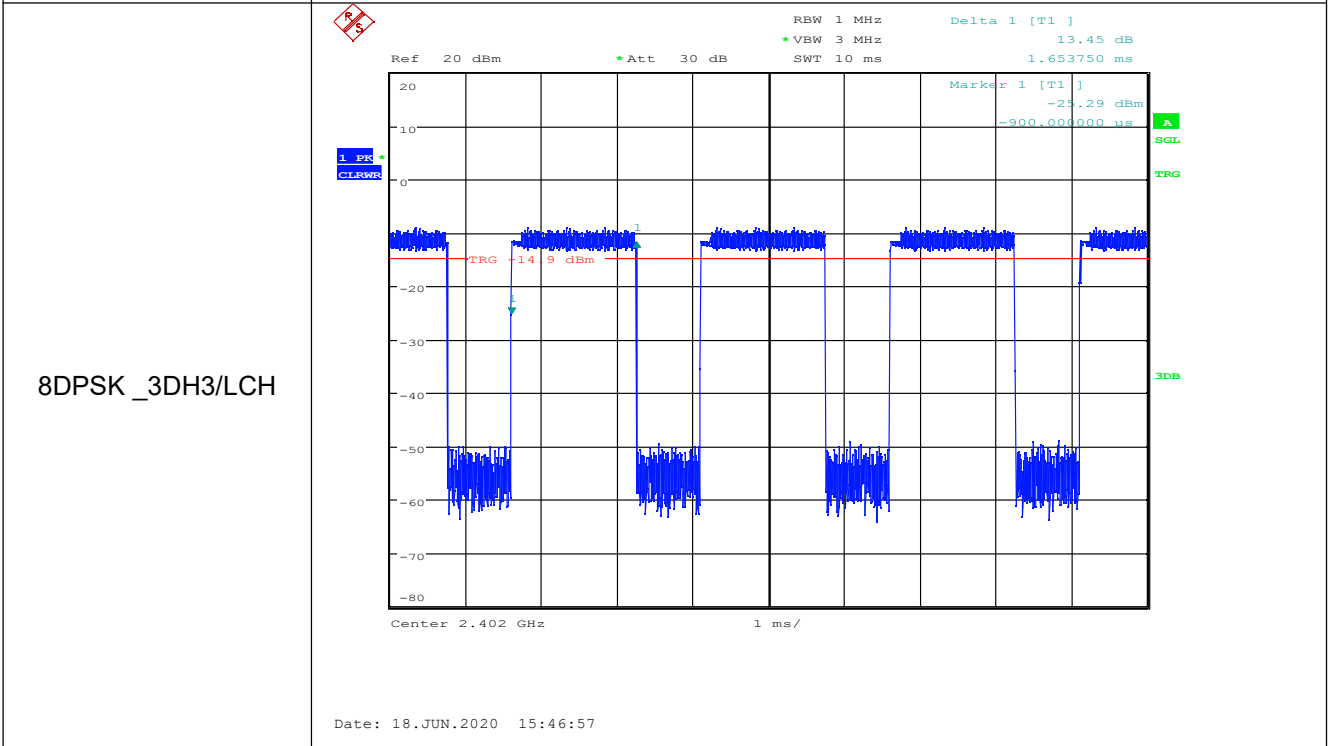
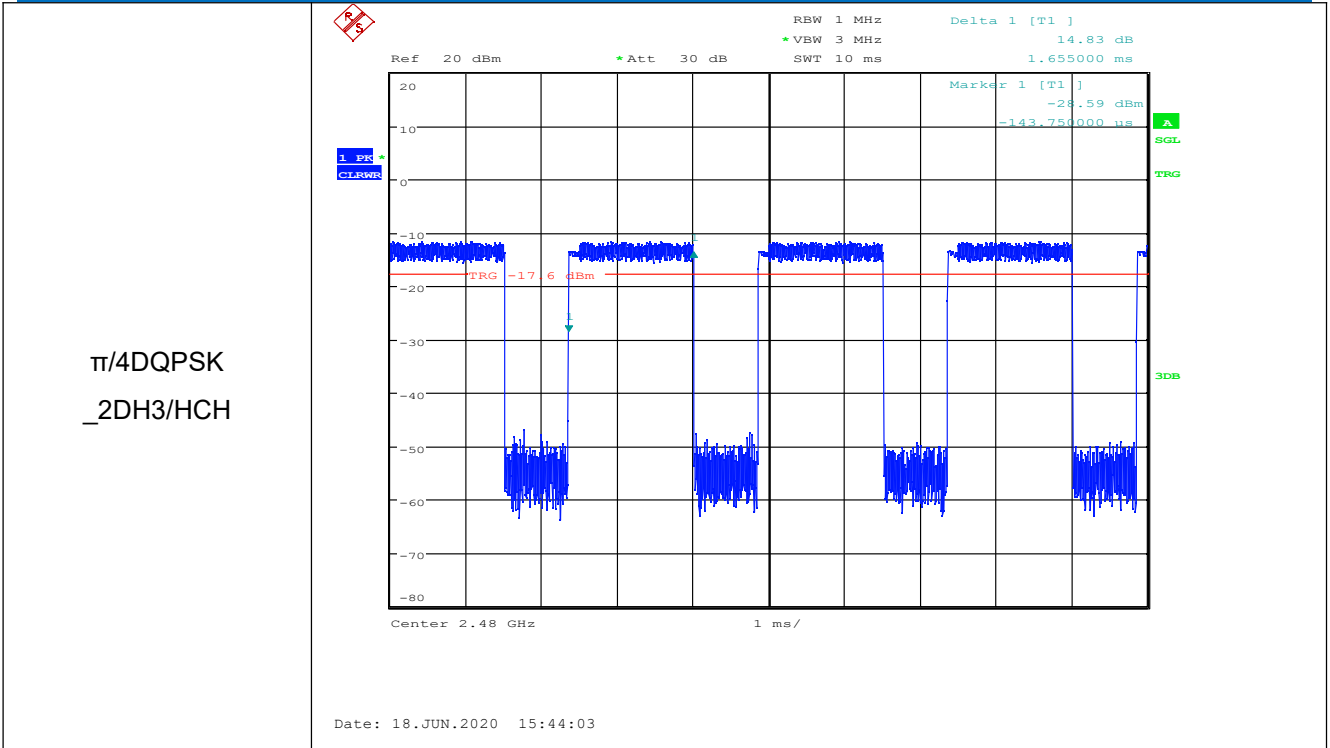

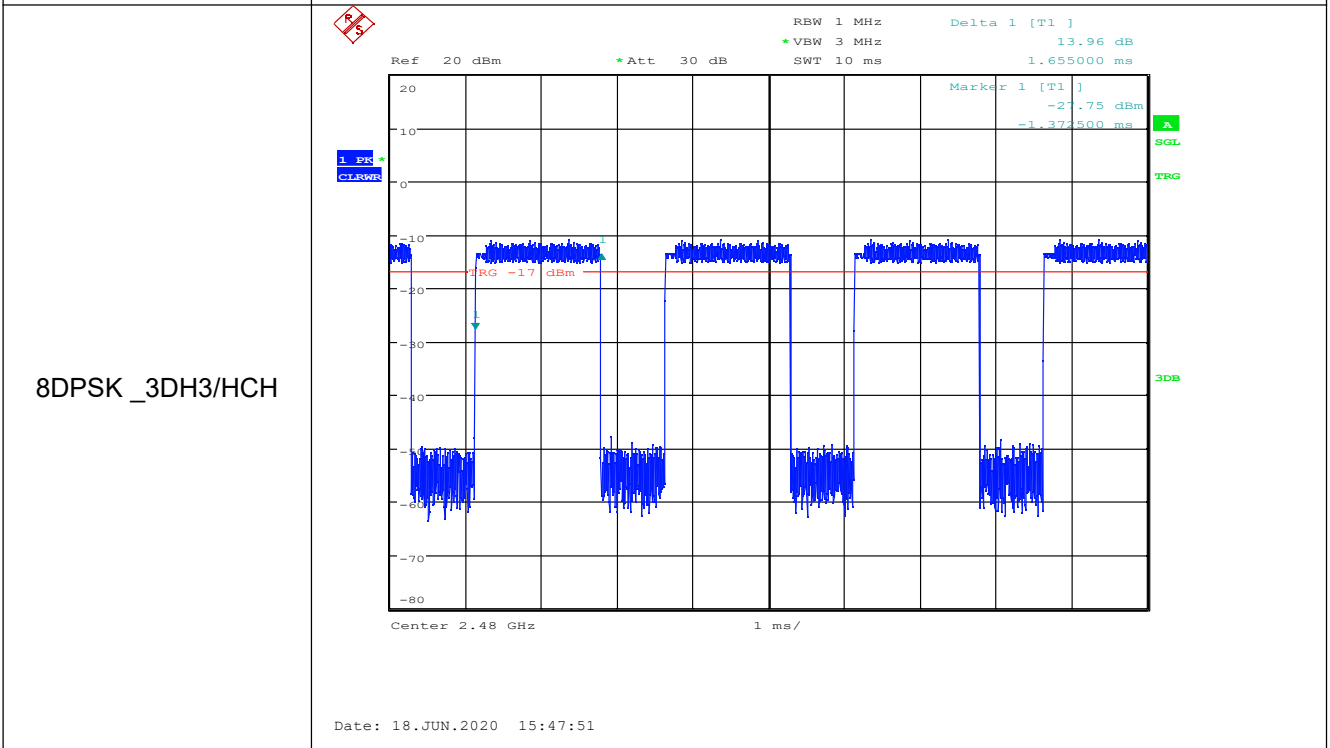
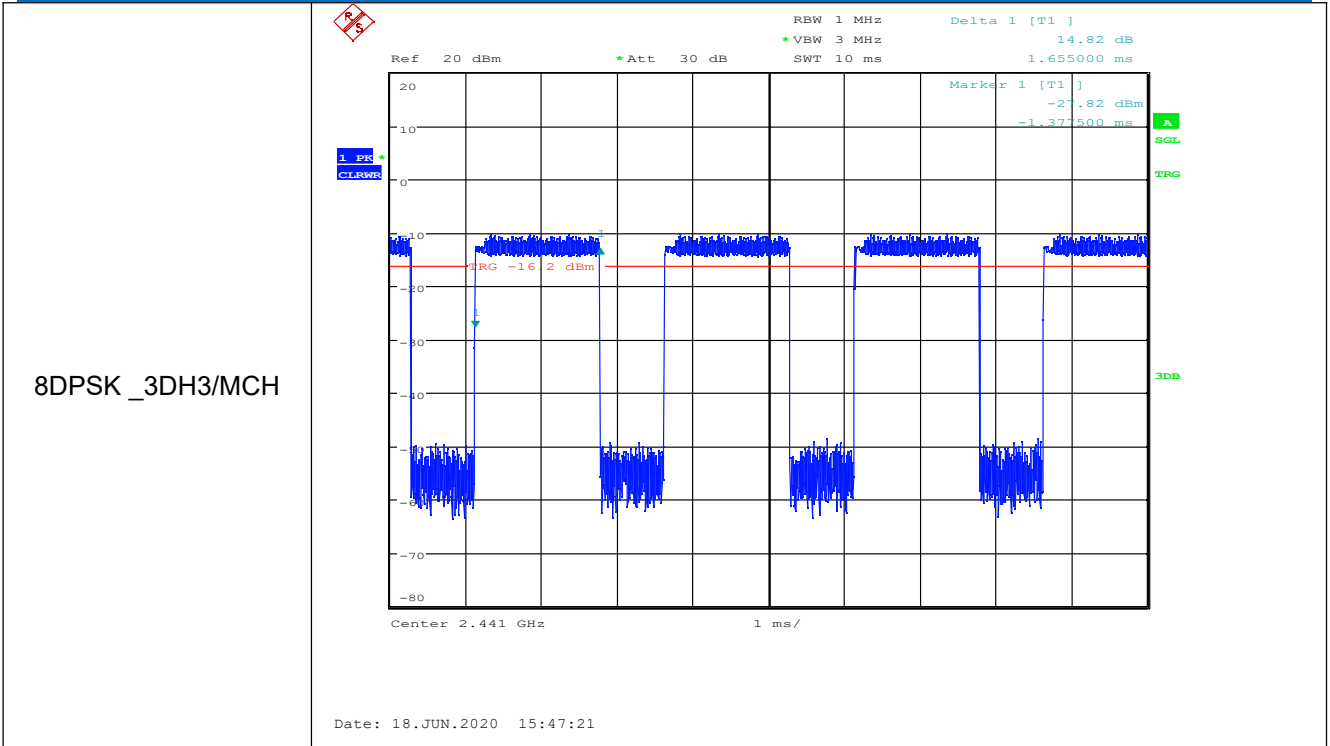

GFSK\_DH5/LCH

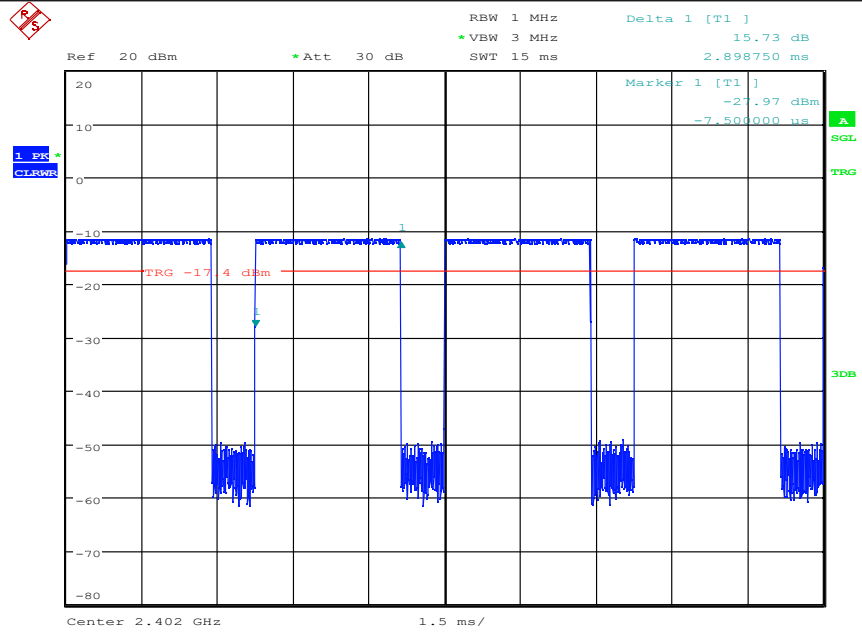

Date: 18.JUN.2020 15:40:48

GFSK\_DH5/MCH

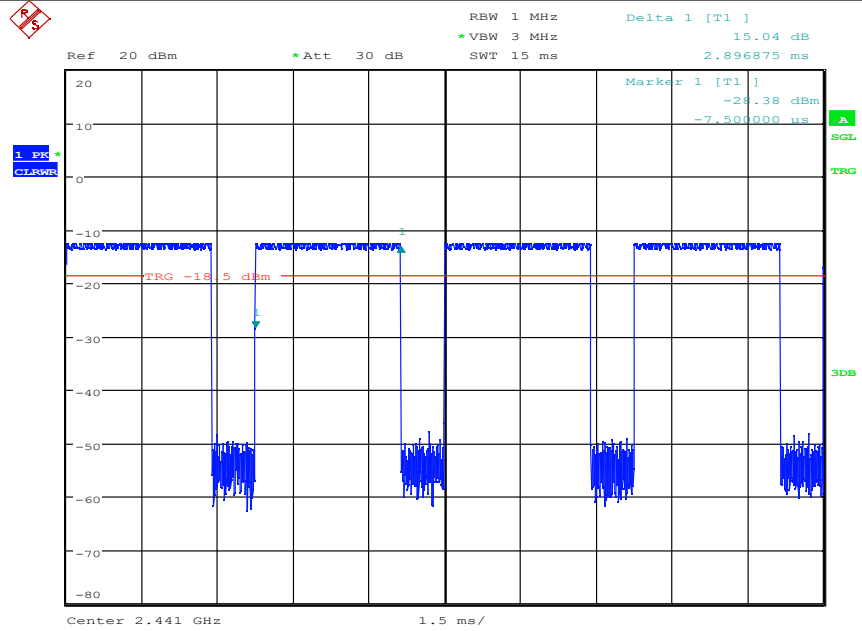

Date: 18.JUN.2020 15:41:11

GFSK\_DH5/HCH

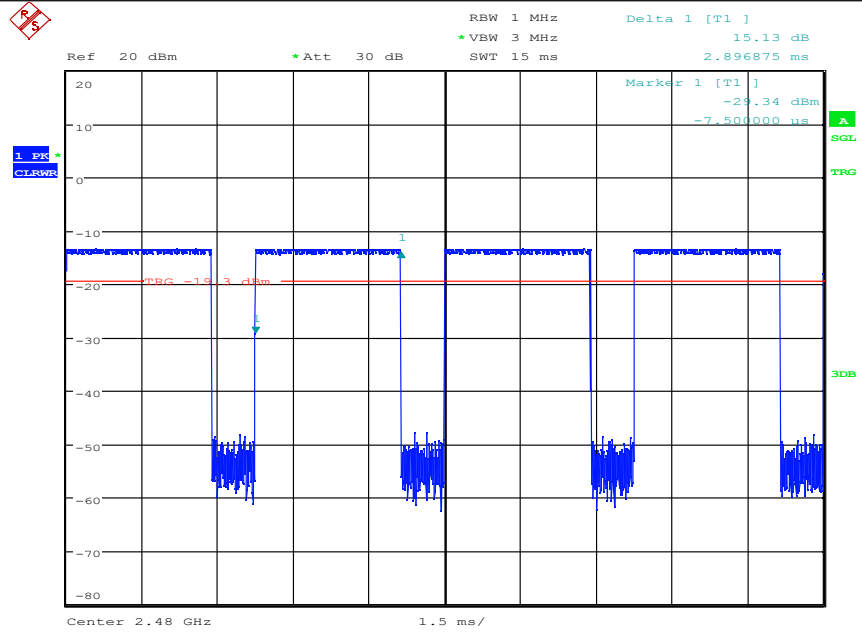

Date: 18.JUN.2020 15:41:35

$\pi/4$ DQPSK  
\_2DH5/LCH

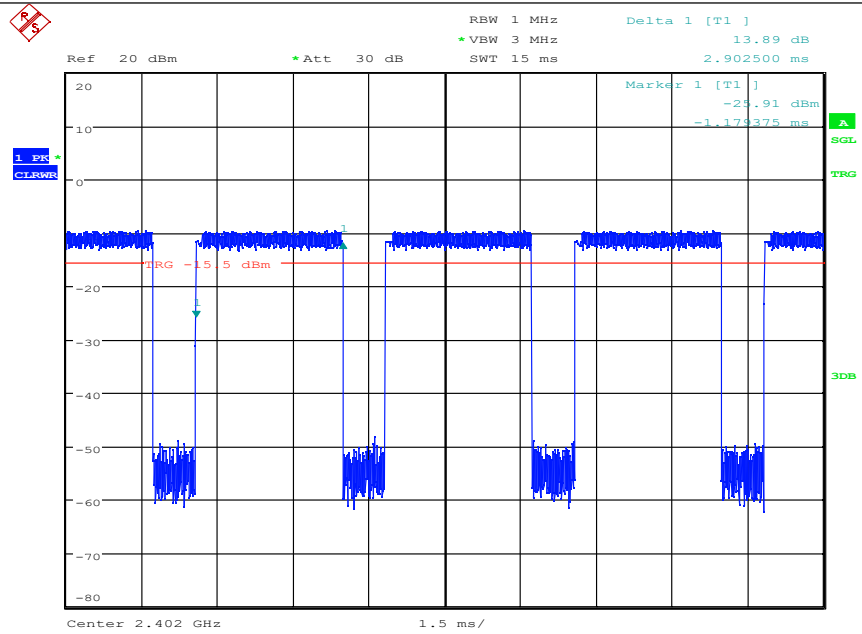

Date: 18.JUN.2020 15:44:34

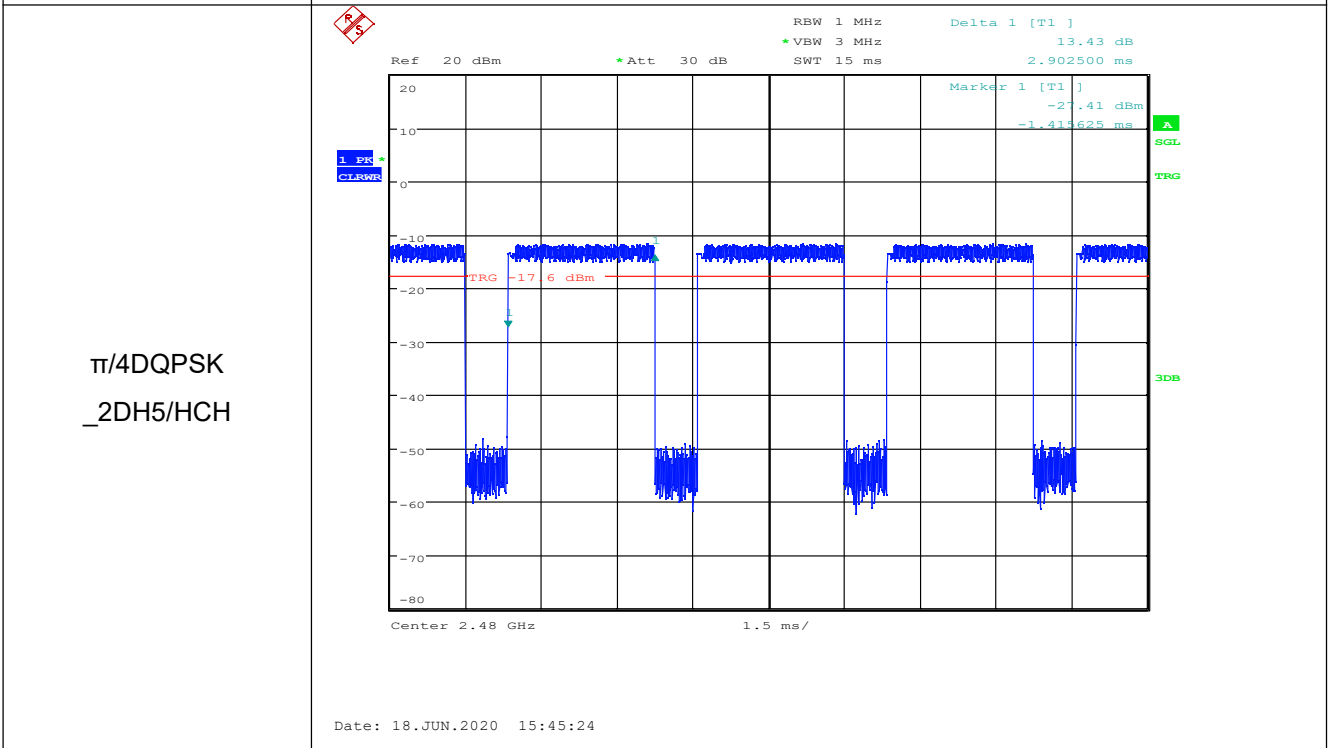
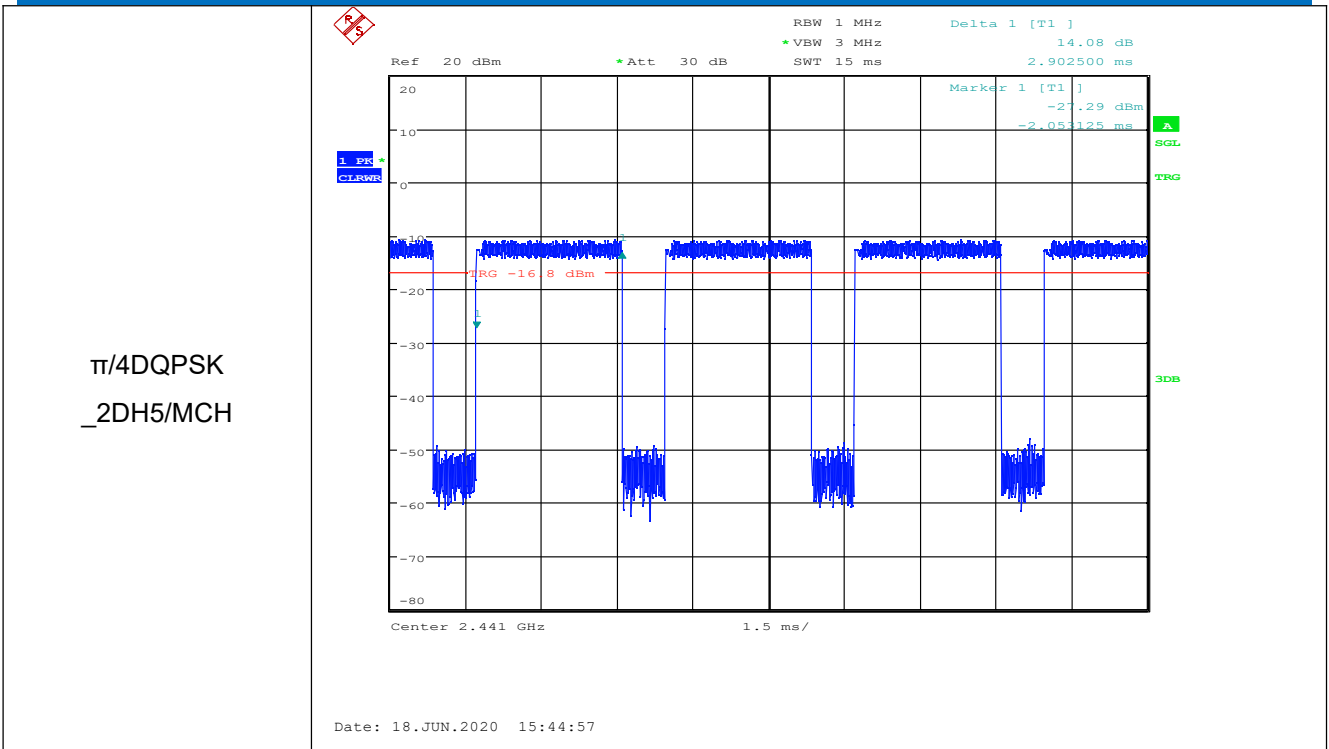

8DPSK\_3DH5/LCH

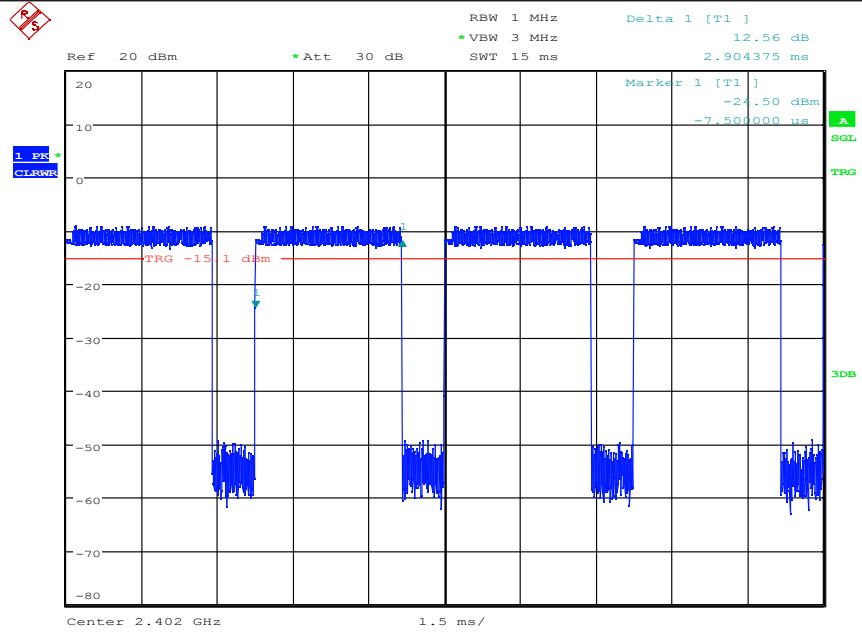

Date: 18.JUN.2020 15:48:26

8DPSK\_3DH5/MCH

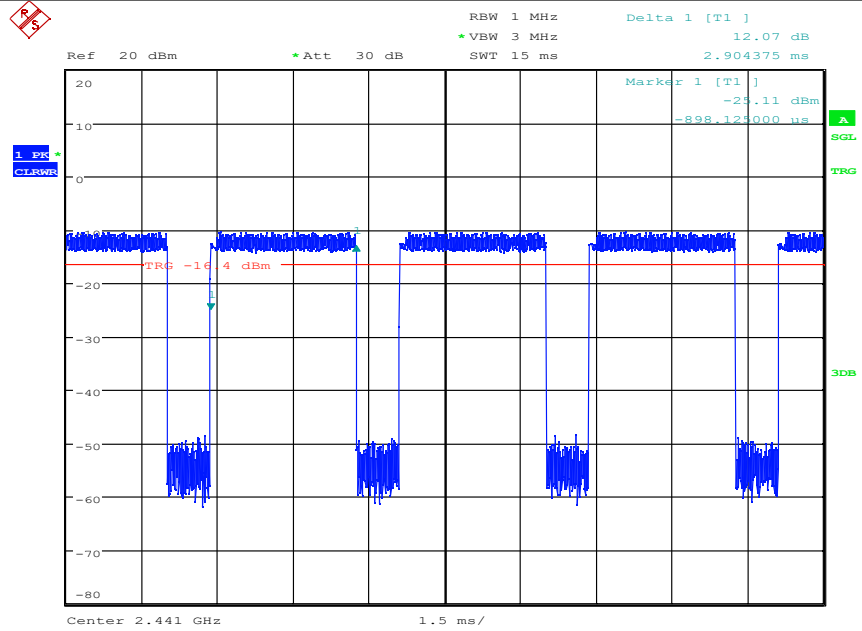

Date: 18.JUN.2020 15:48:56

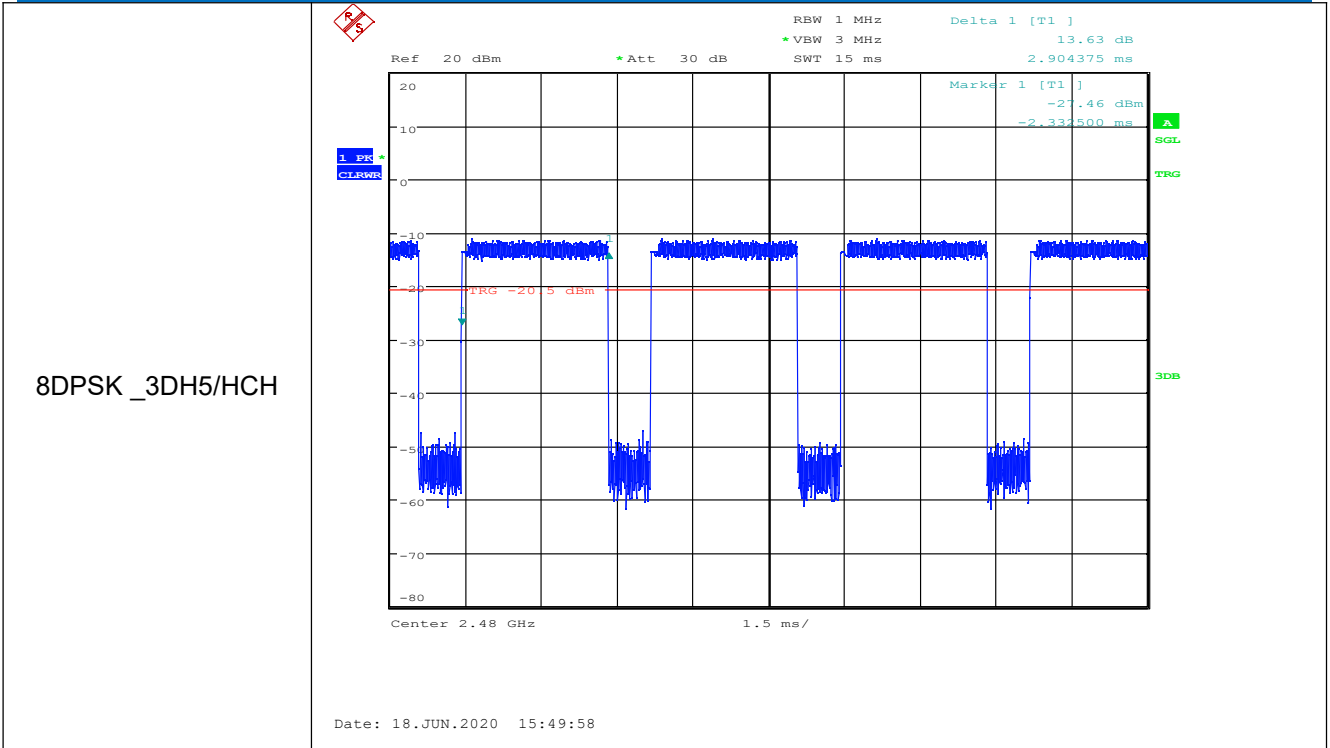

#### 4.8 Band-edge for RF Conducted Emissions

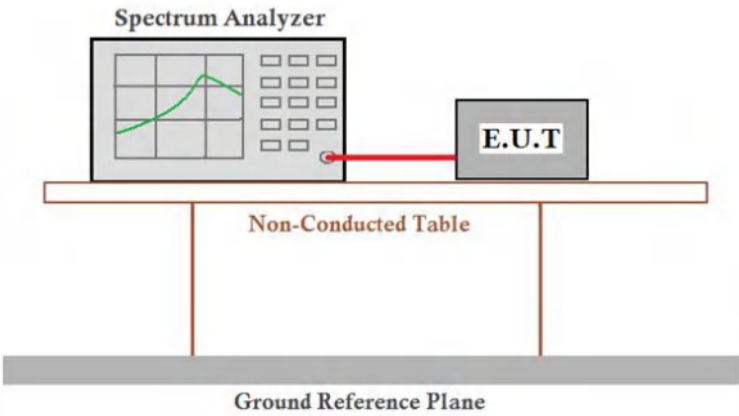
|                        |   |
|------------------------|---|
| Test Requirement:      | 47 CFR Part 15C Section 15.247 (d)  |
| Test Method:           | ANSI C63.10:2013  |
| Test Setup:            |  <p style="text-align: center;"><i>Remark: Offset=cable loss+ attenuation factor.</i></p>   |
| Limit:                 | In any 100 kHz bandwidth outside the frequency band in which the spread spectrum intentional radiator is operating, the radio frequency power that is produced by the intentional radiator shall be at least 20 dB below that in the 100 kHz bandwidth within the band that contains the highest level of the desired power, based on either an RF conducted or a radiated measurement. |
| Exploratory Test Mode: | Hopping and Non-hopping transmitting with all kind of modulation and all kind of data type  |
| Final Test Mode:       | Through Pre-scan, find the DH5 of data type is the worst case of GFSK modulation type, 2-DH5 of data type is the worst case of $\pi/4$ DQPSK modulation type, 3-DH5 of data type is the worst case of 8DPSK modulation type.<br>Only the worst case is recorded in the report.  |
| Test Results:          | Pass  |



| Mode          | Test Channel | Frequency [MHz] | Frequency Hopping | Emission Level [dBm] | Limit [dBm] | Result |
|---------------|--------------|-----------------|-------------------|----------------------|-------------|--------|
| GFSK          | LCH          | 2400            | Off               | -50.240              | -23.73      | PASS   |
|               |              |                 | On                | -46.260              | -23.44      | PASS   |
| GFSK          | HCH          | 2483.5          | Off               | -48.920              | -25.39      | PASS   |
|               |              |                 | On                | -45.430              | -25.06      | PASS   |
| $\pi/4$ DQPSK | LCH          | 2400            | Off               | -49.700              | -24.39      | PASS   |
|               |              |                 | On                | -46.440              | -23.55      | PASS   |
| $\pi/4$ DQPSK | HCH          | 2483.5          | Off               | -49.270              | -25.51      | PASS   |
|               |              |                 | On                | -45.190              | -25         | PASS   |
| 8DPSK         | LCH          | 2400            | Off               | -48.980              | -23.41      | PASS   |
|               |              |                 | On                | -46.650              | -23.45      | PASS   |
| 8DPSK         | HCH          | 2483.5          | Off               | -50.960              | -25.47      | PASS   |
|               |              |                 | On                | -45.870              | -24.96      | PASS   |

Test plot as follows:

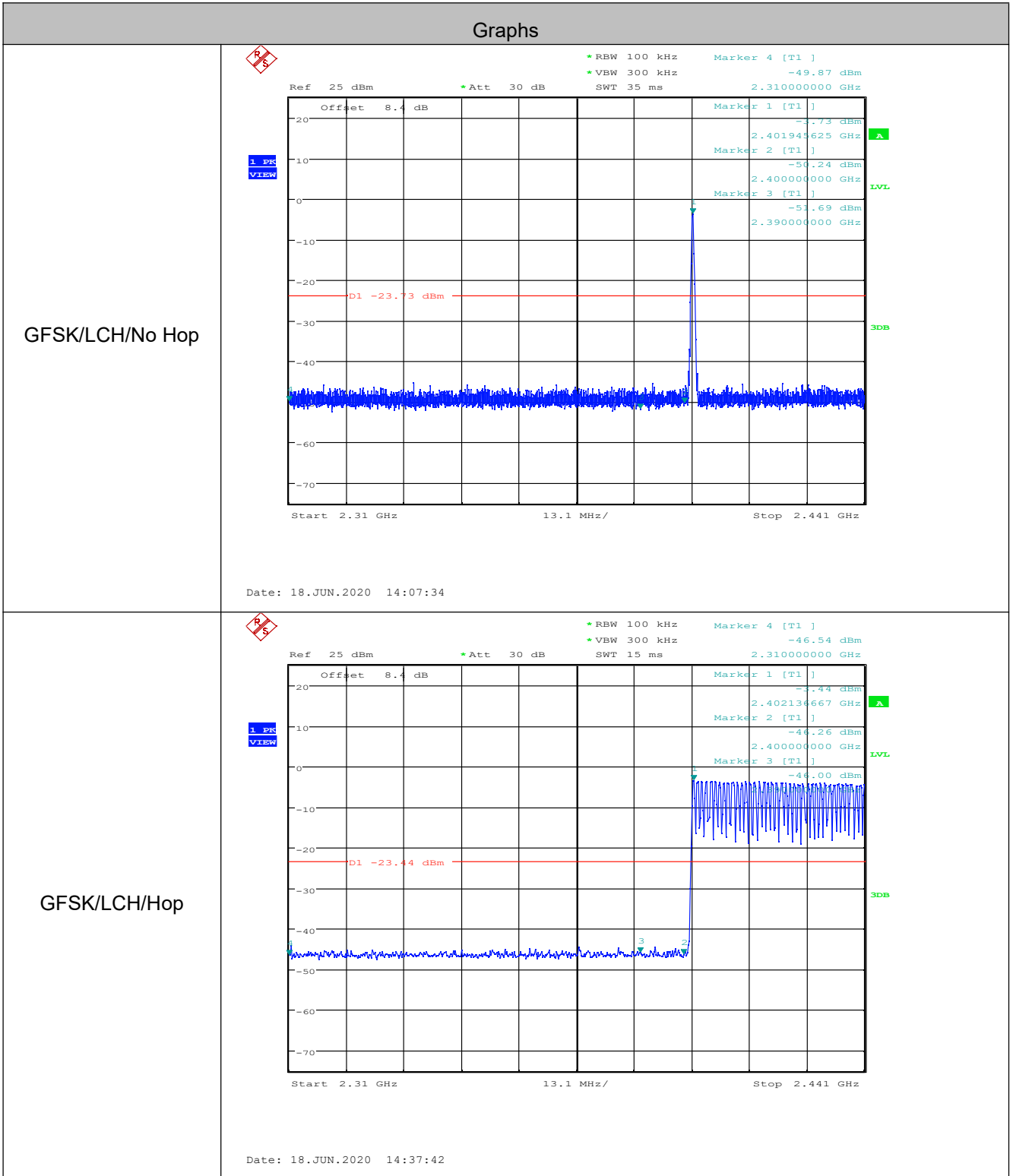

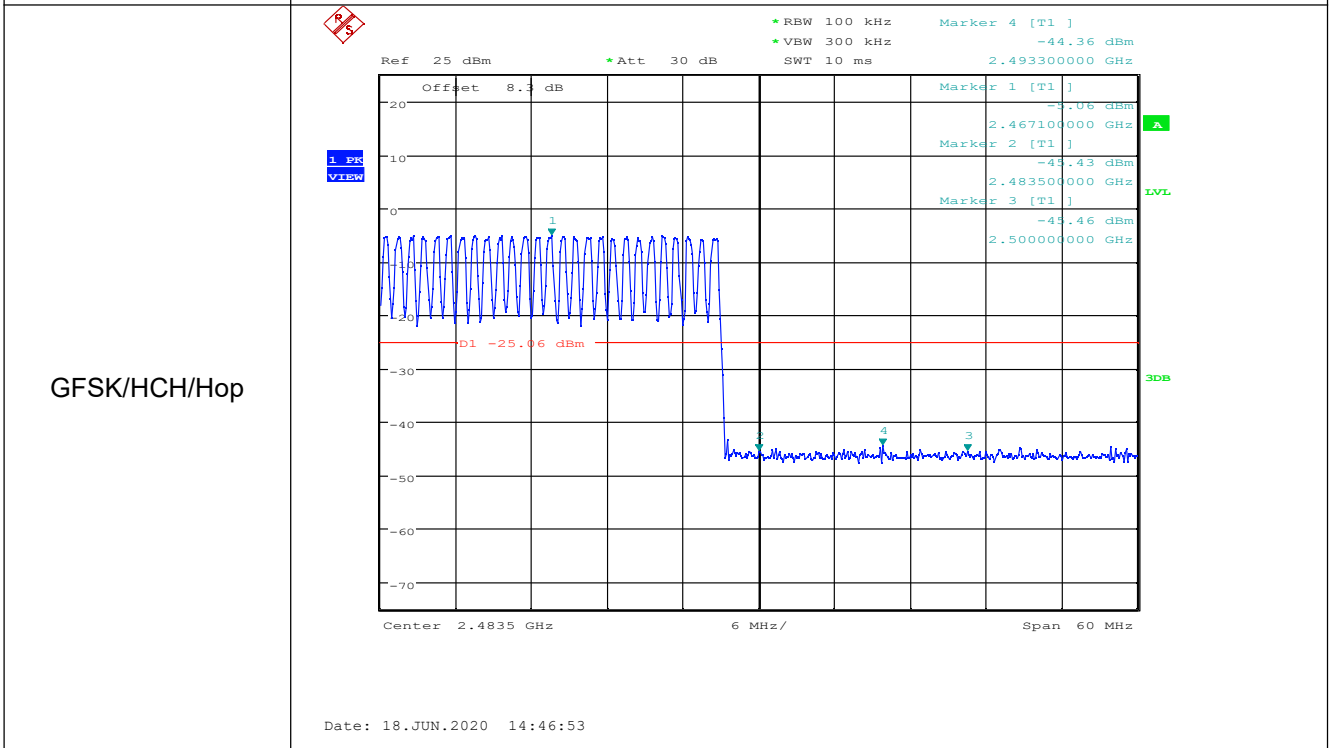
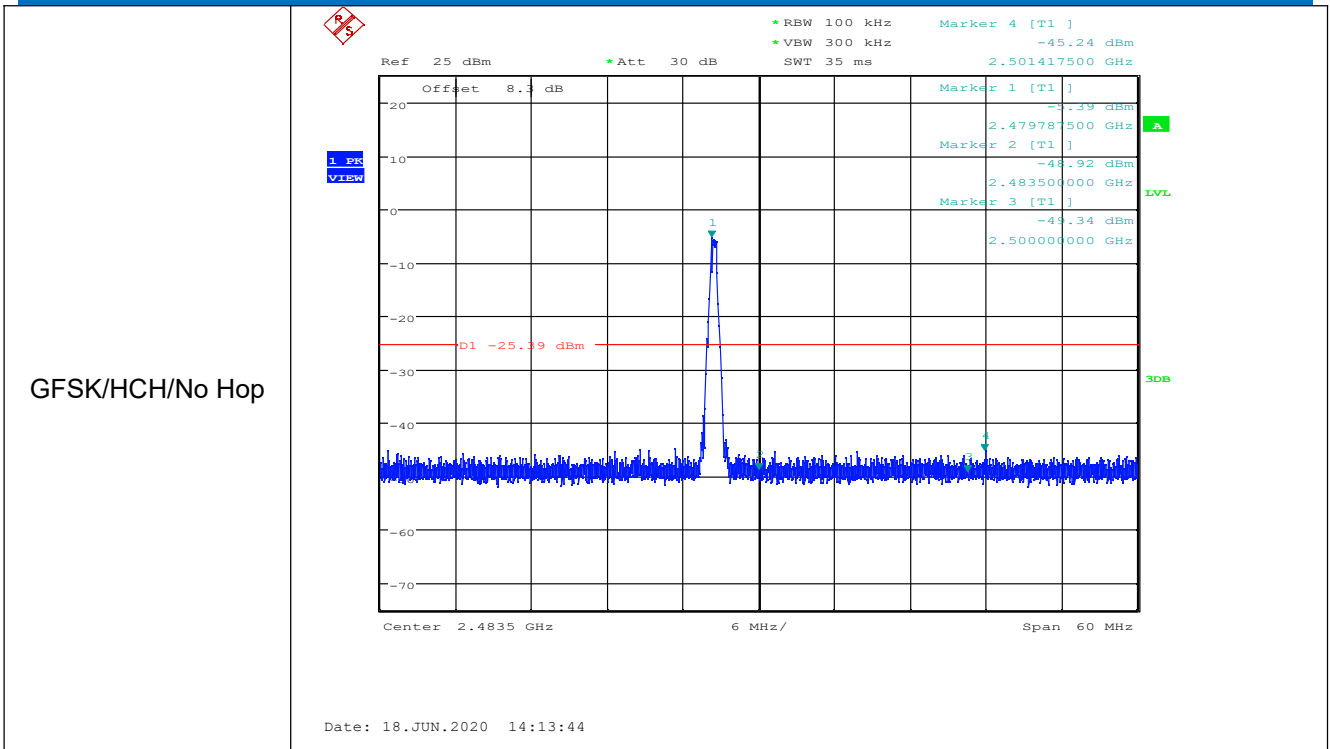

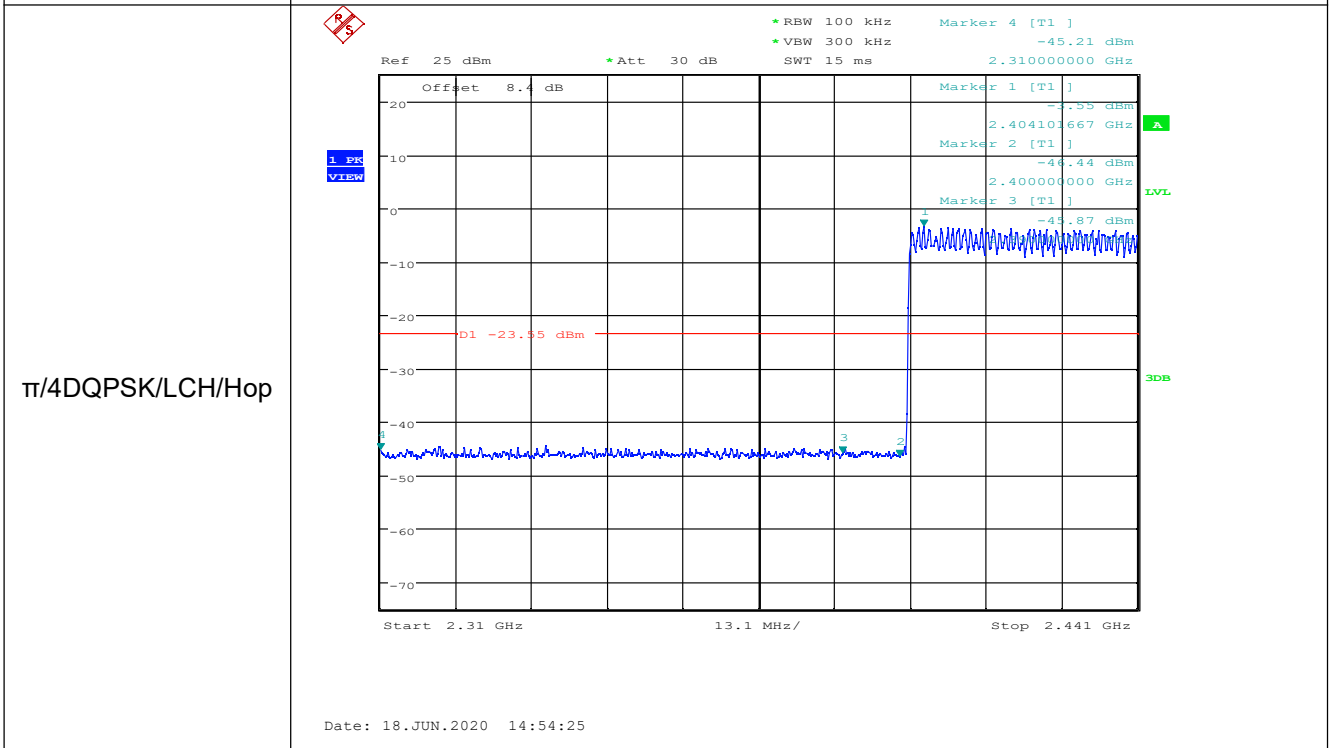
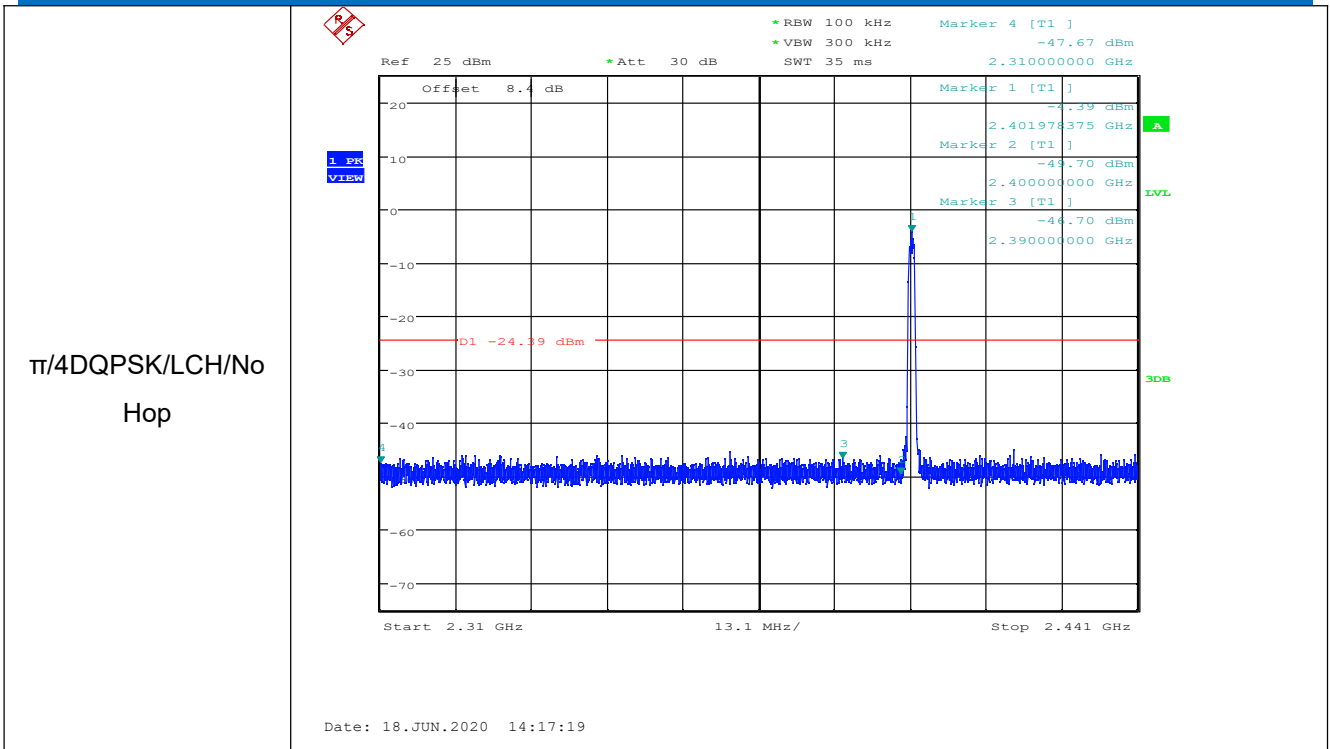

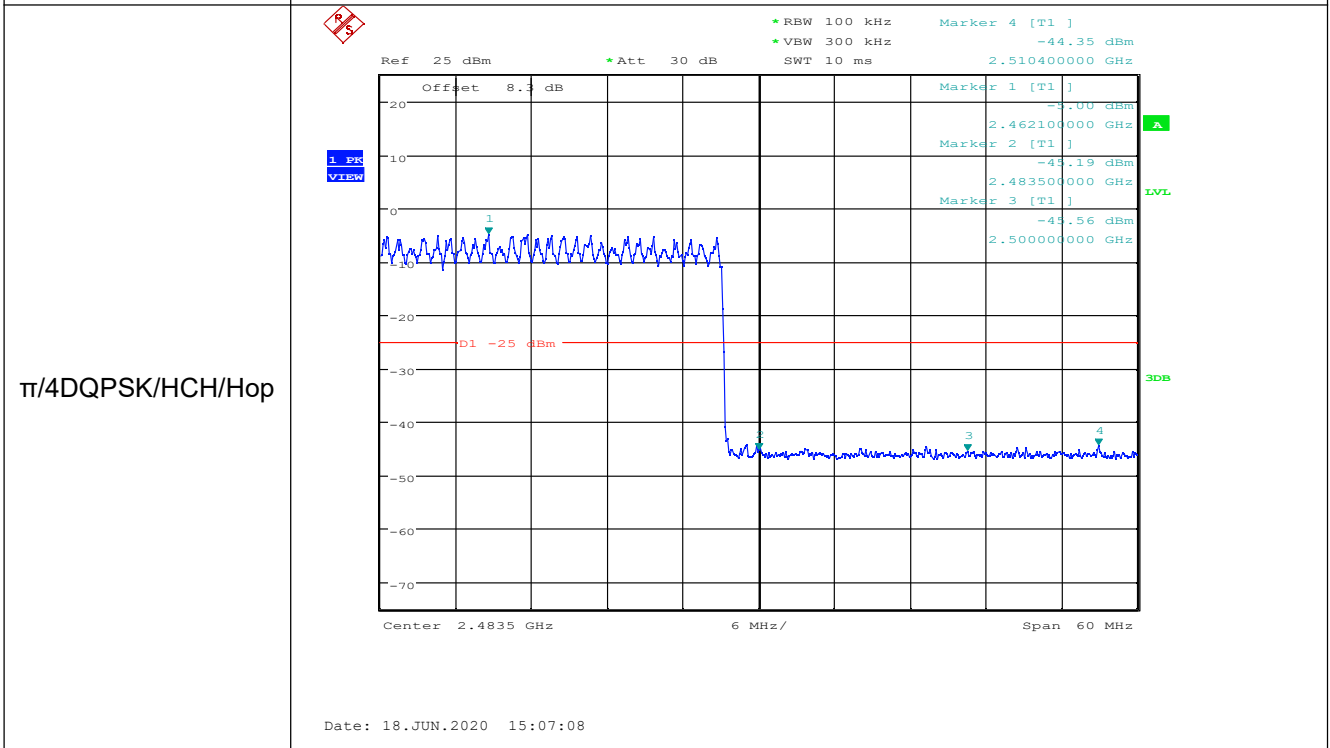
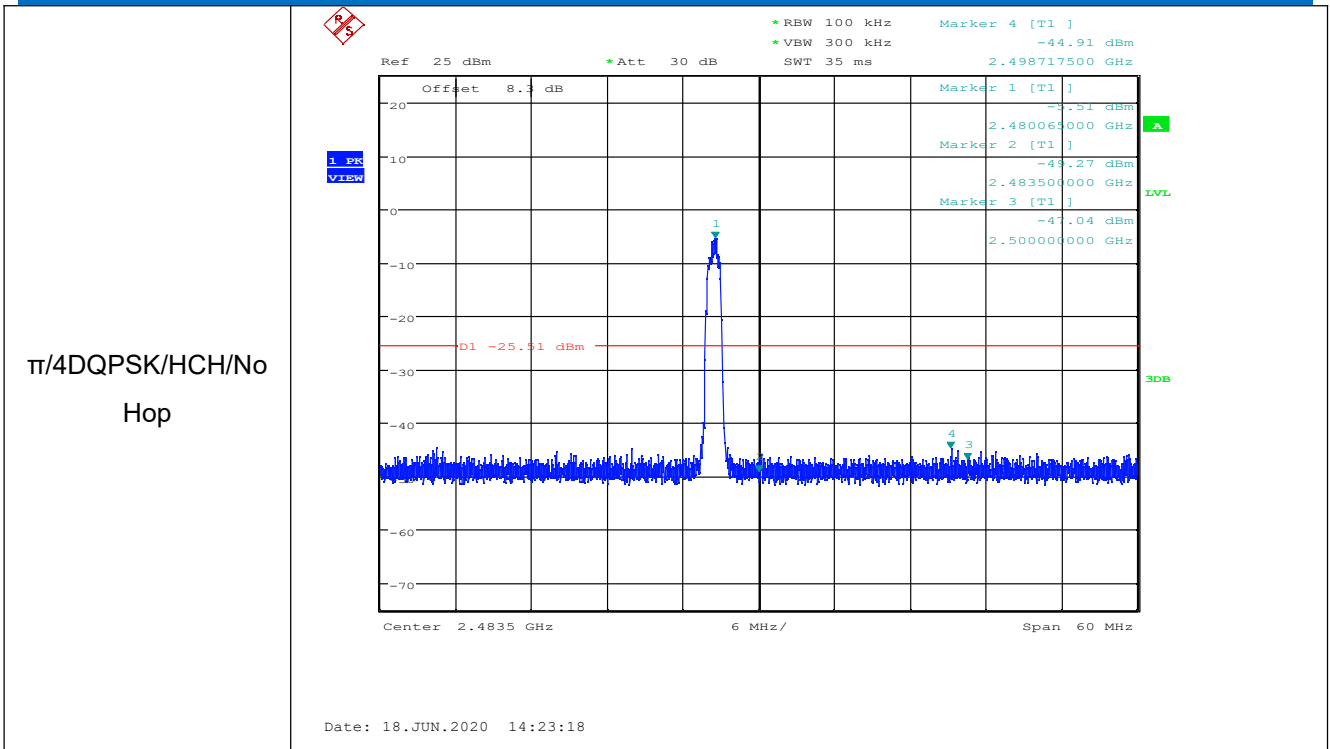

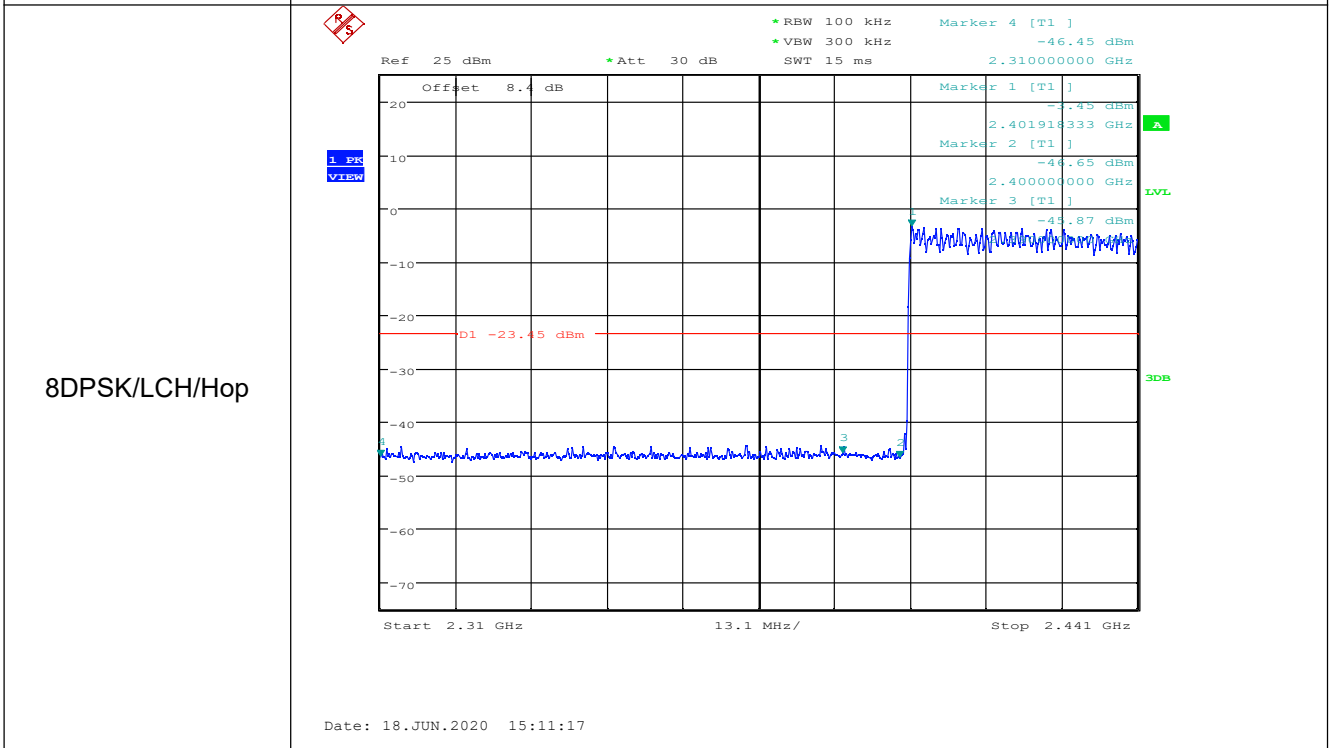
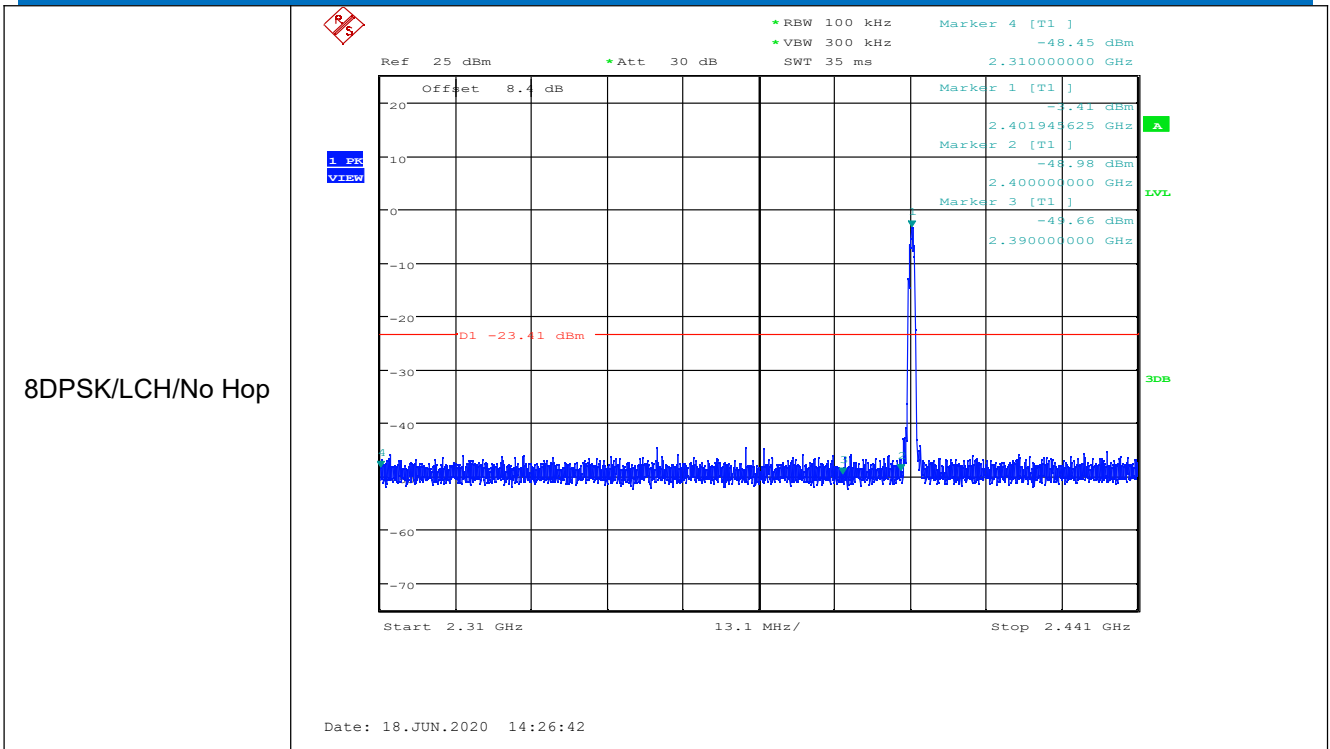

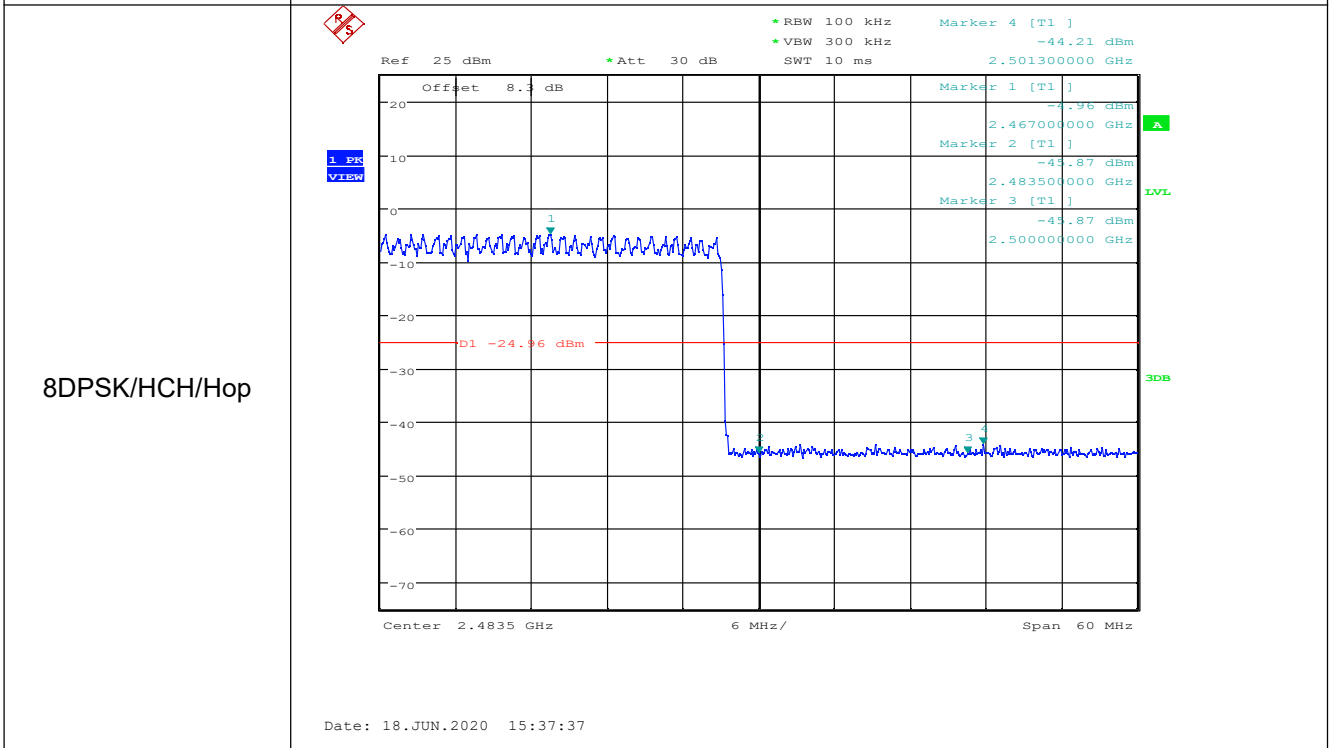
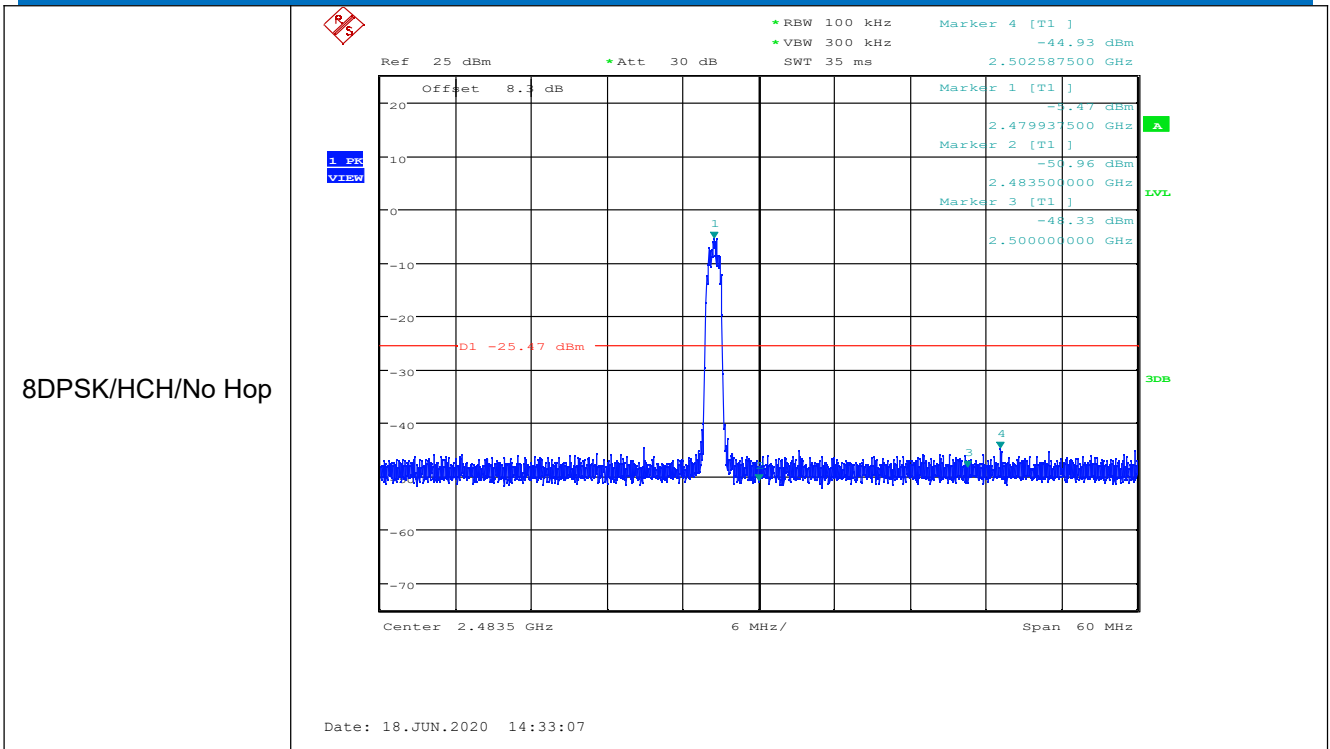

#### 4.9 Spurious RF Conducted Emissions

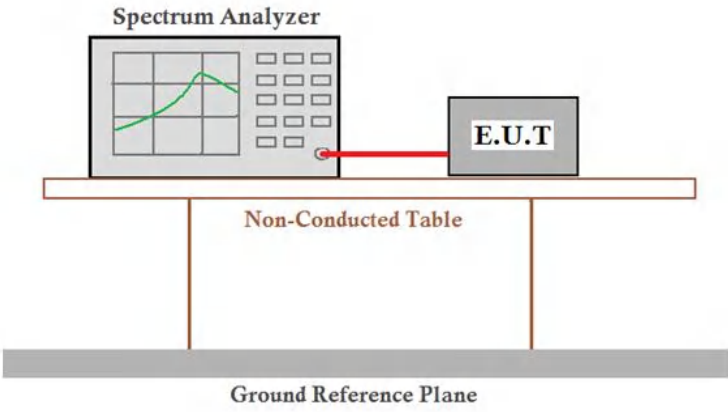
|                        |   |
|------------------------|---|
| Test Requirement:      | 47 CFR Part 15C Section 15.247 (d)  |
| Test Method:           | ANSI C63.10:2013  |
| Test Setup:            |  <p style="text-align: center;"><i>Remark: Offset=cable loss+ attenuation factor.</i></p>   |
| Limit:                 | In any 100 kHz bandwidth outside the frequency band in which the spread spectrum intentional radiator is operating, the radio frequency power that is produced by the intentional radiator shall be at least 20 dB below that in the 100 kHz bandwidth within the band that contains the highest level of the desired power, based on either an RF conducted or a radiated measurement. |
| Exploratory Test Mode: | Non-hopping transmitting with all kind of modulation and all kind of data type  |
| Final Test Mode:       | Through Pre-scan, find the DH5 of data type is the worst case of GFSK modulation type, 2-DH5 of data type is the worst case of $\pi/4$ DQPSK modulation type, 3-DH5 of data type is the worst case of 8DPSK modulation type.<br>Only the worst case is recorded in the report.  |
| Test Results:          | Pass  |



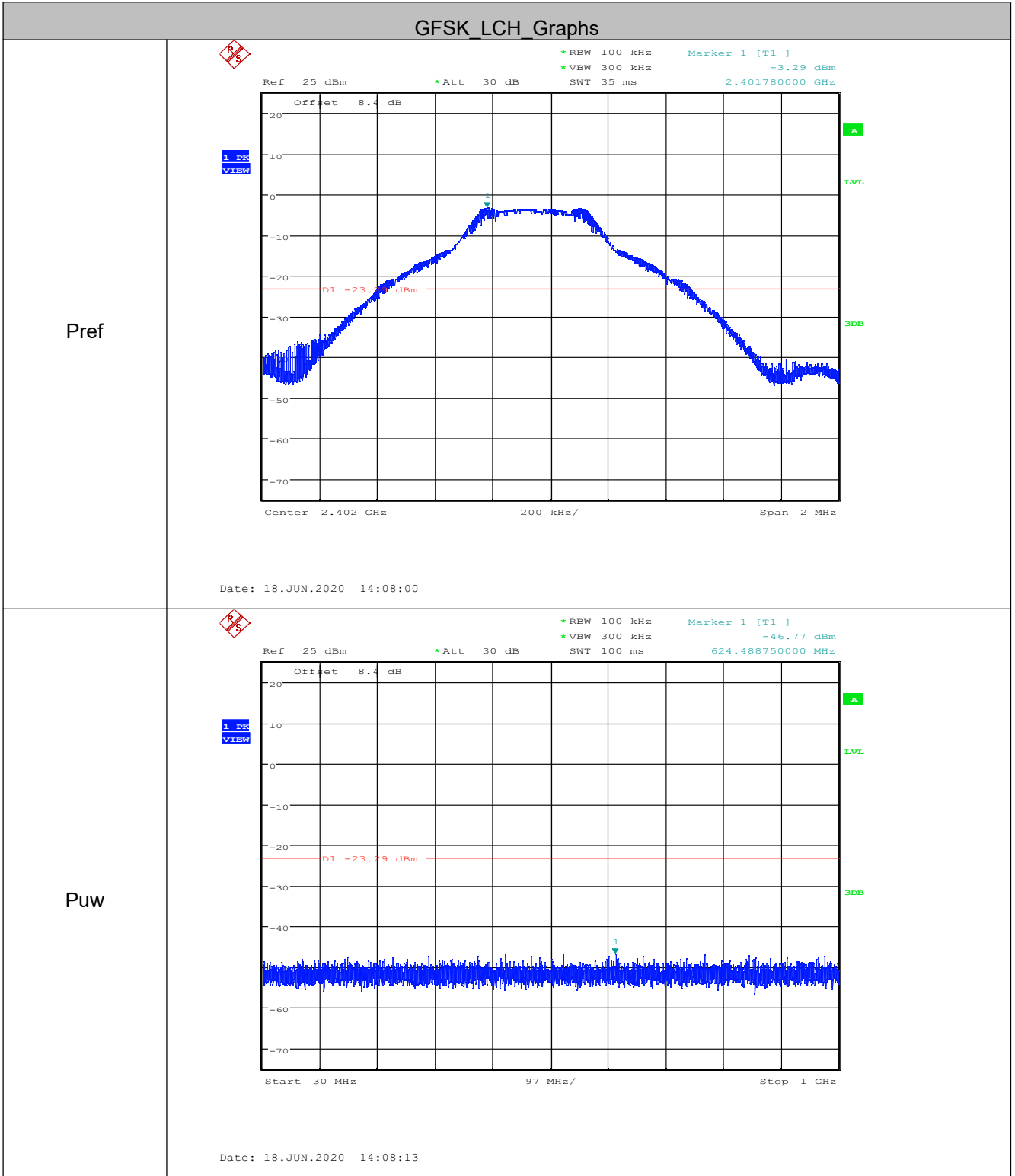

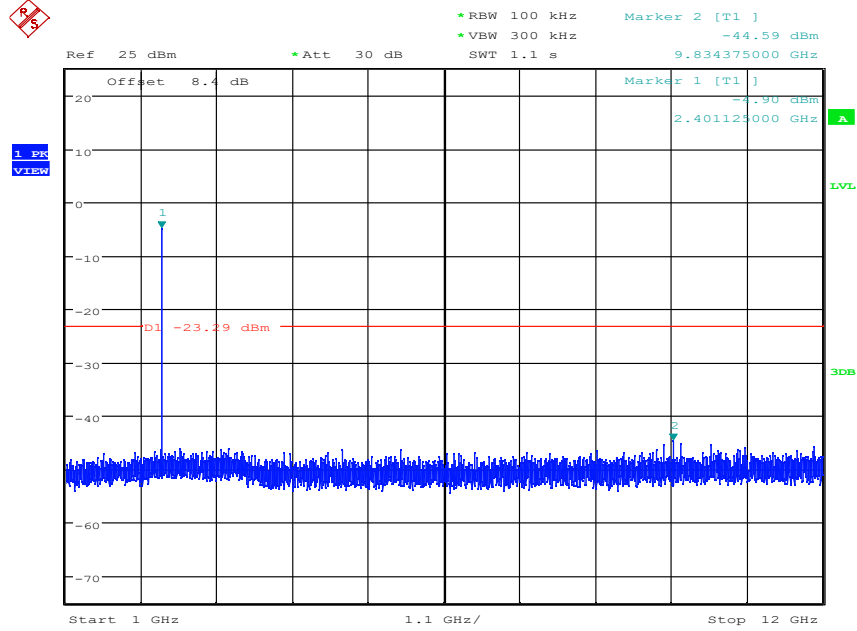

Date: 18.JUN.2020 14:08:24

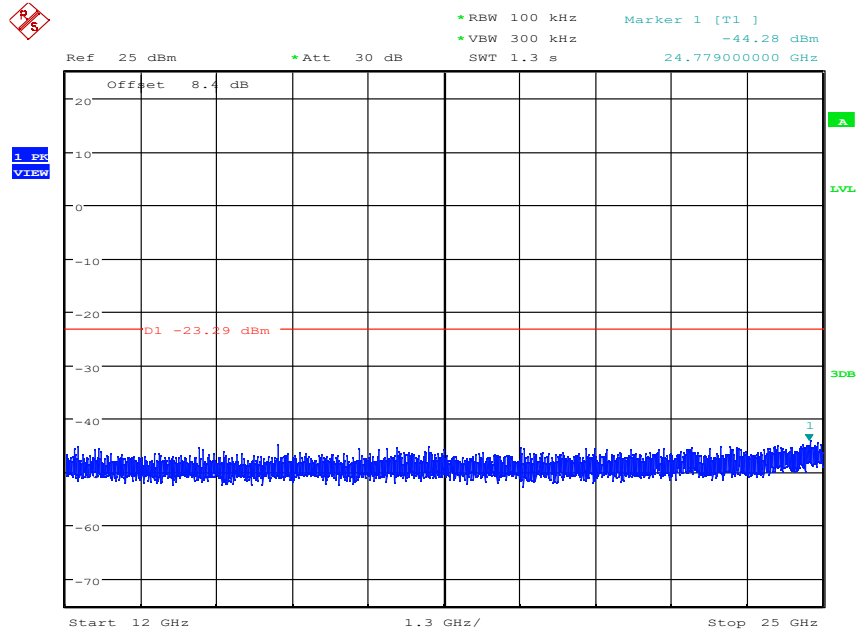

Date: 18.JUN.2020 14:08:36

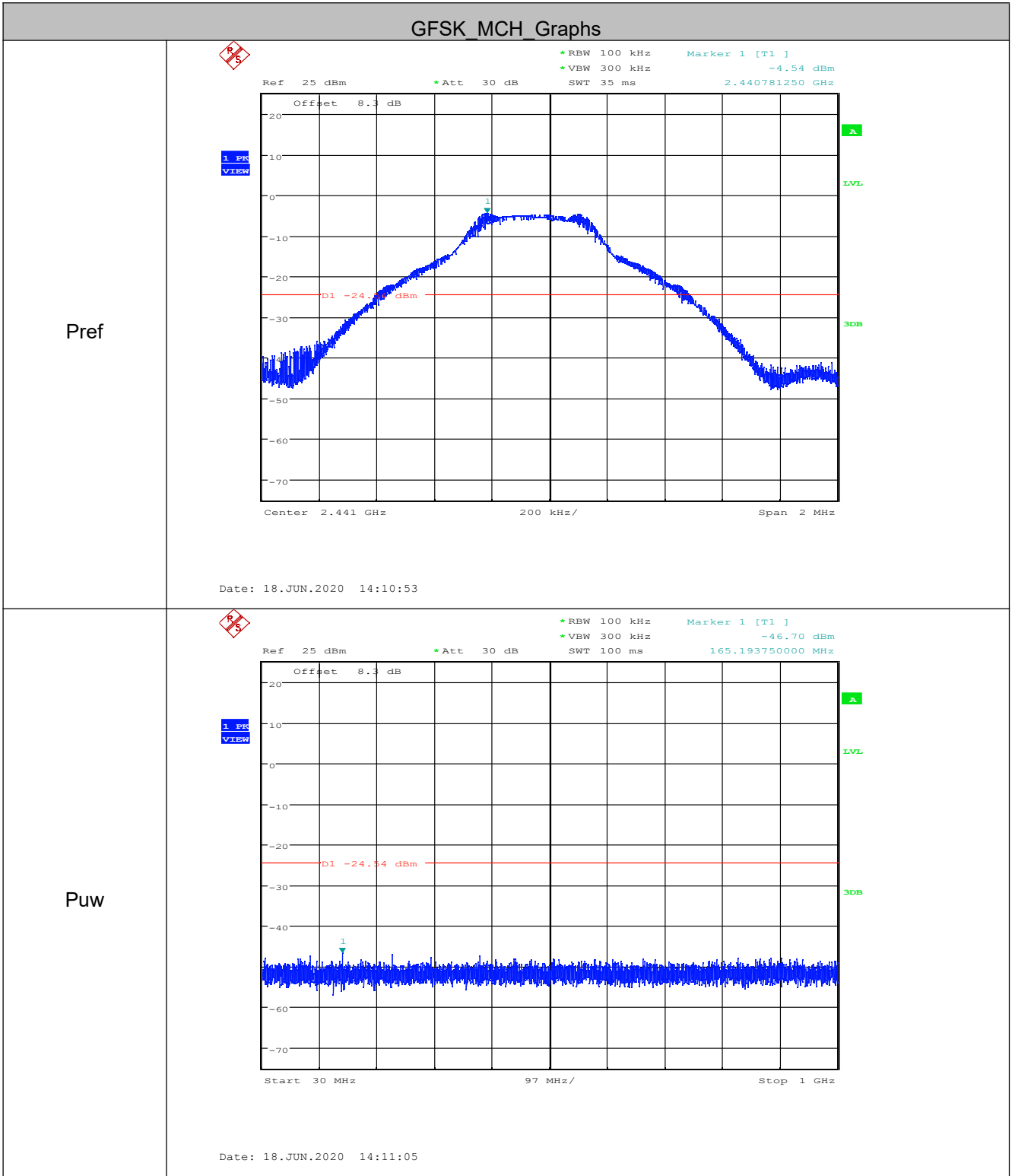



1 PK  
VIEW

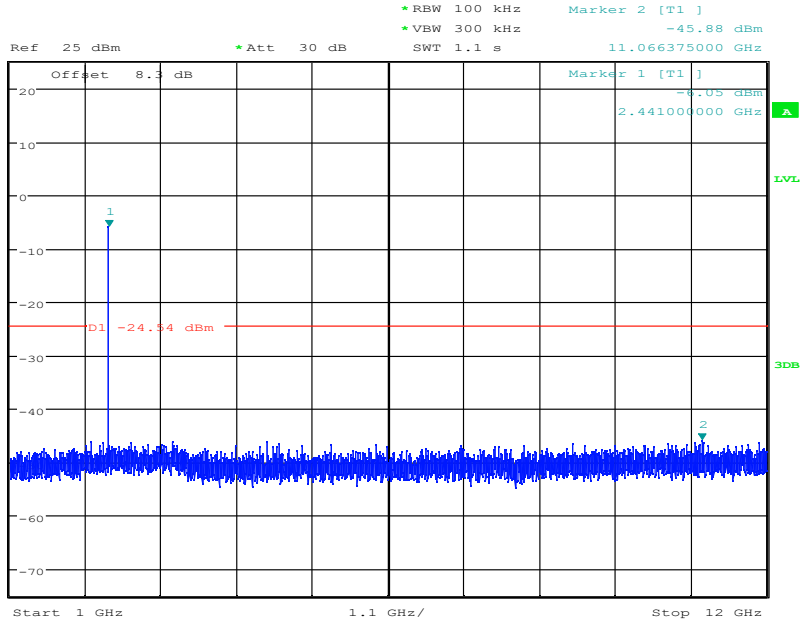

Date: 18.JUN.2020 14:11:17



1 PK  
VIEW

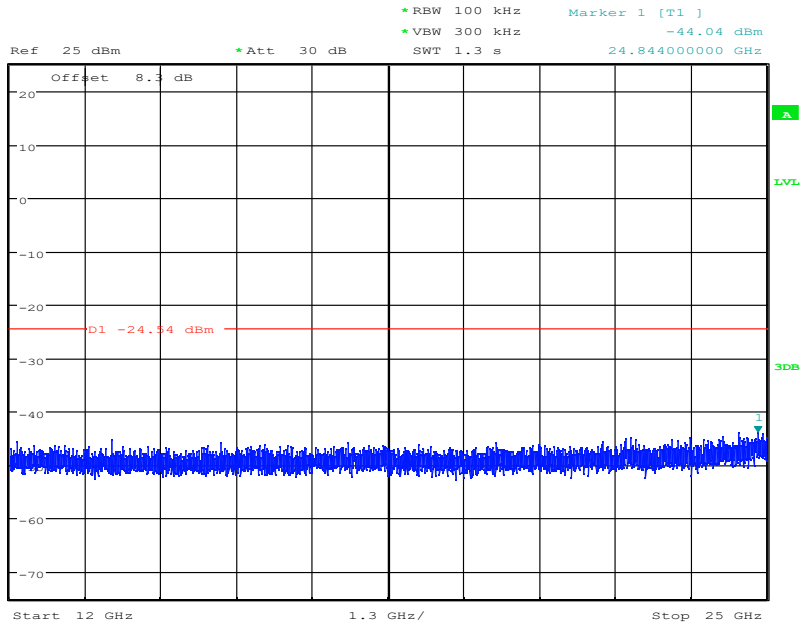

Date: 18.JUN.2020 14:11:29

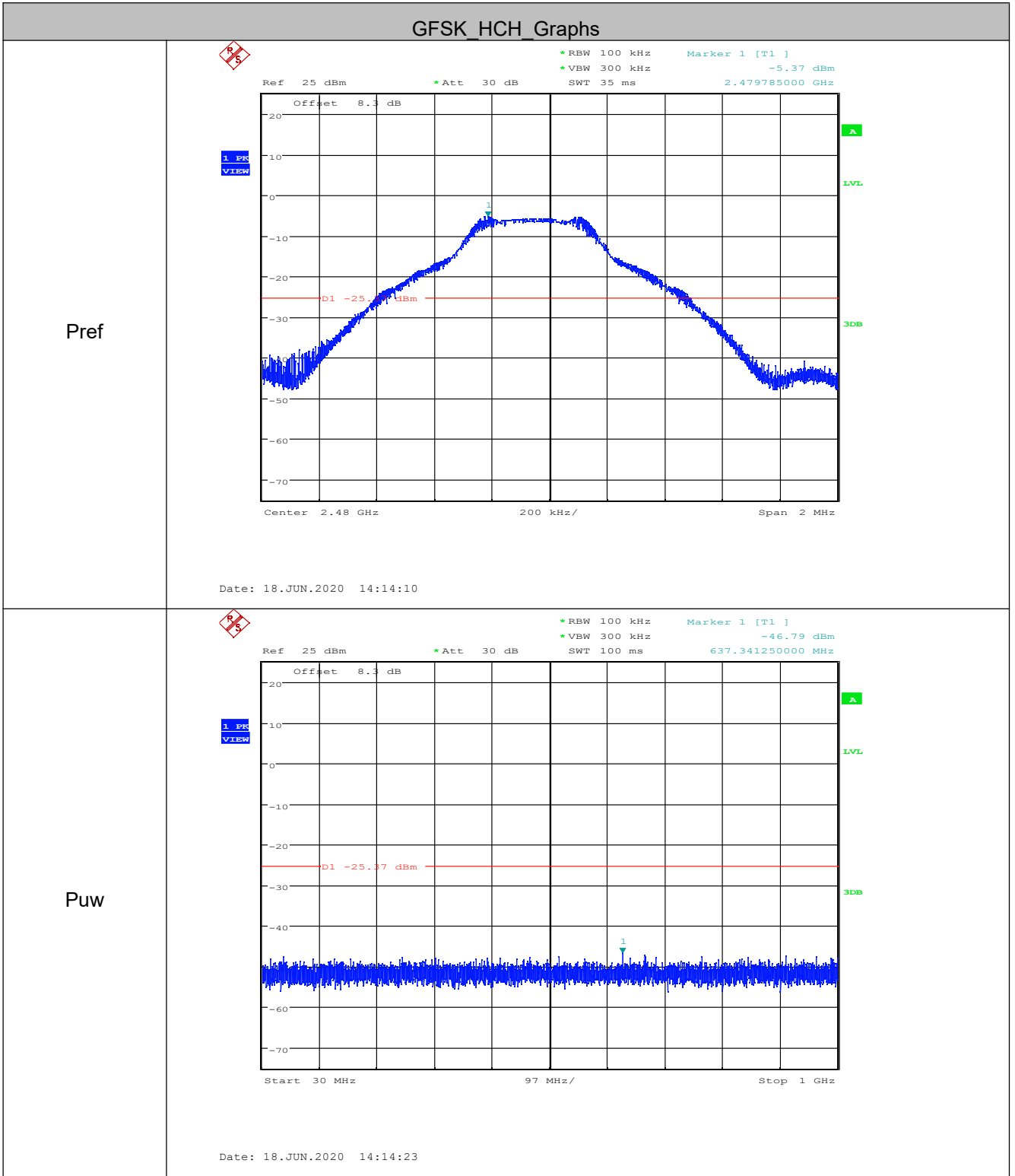



1 PK  
VIEW

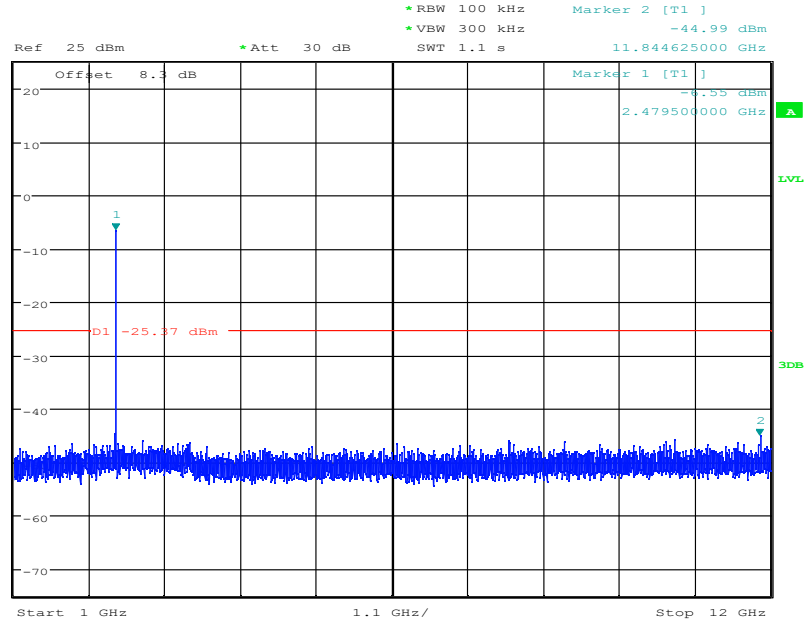

Date: 18.JUN.2020 14:14:34



1 PK  
VIEW

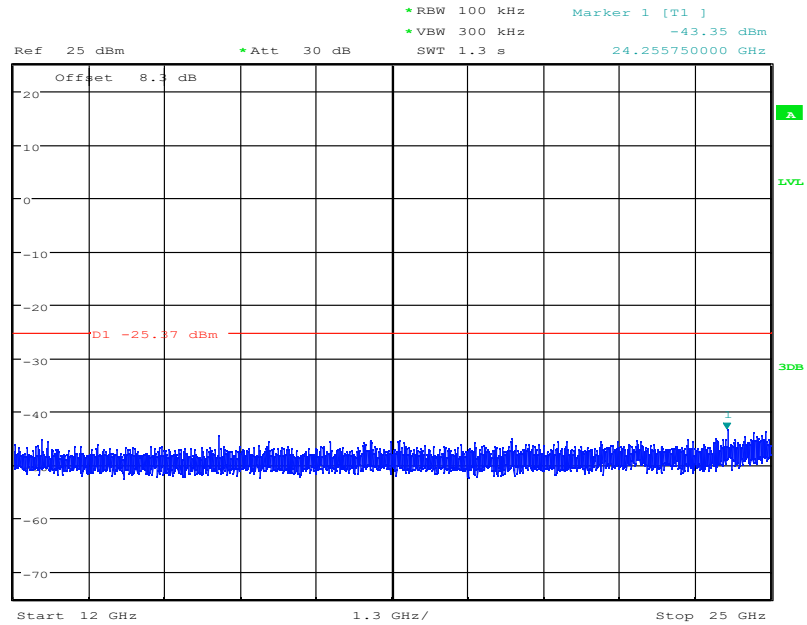

Date: 18.JUN.2020 14:14:47

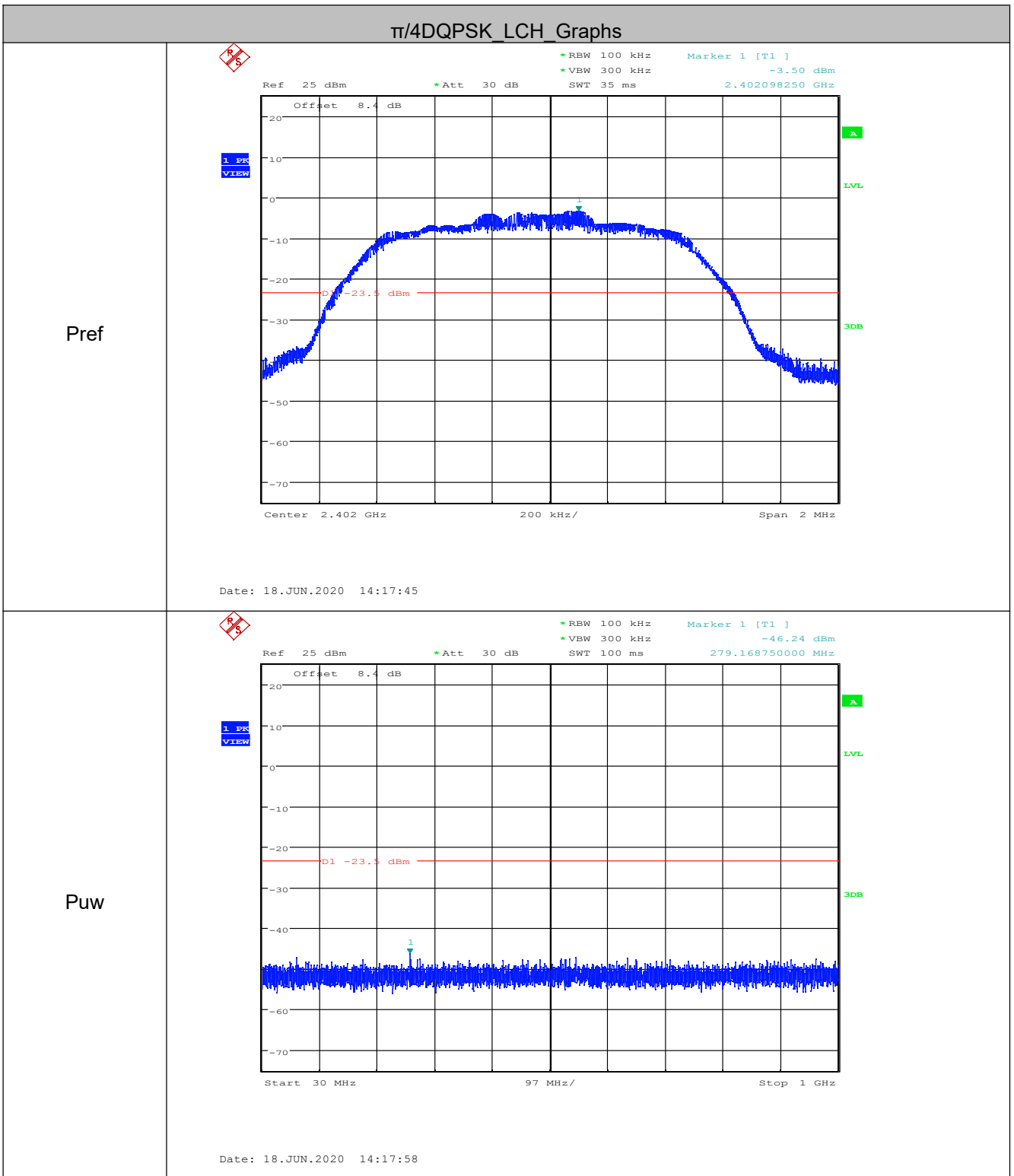

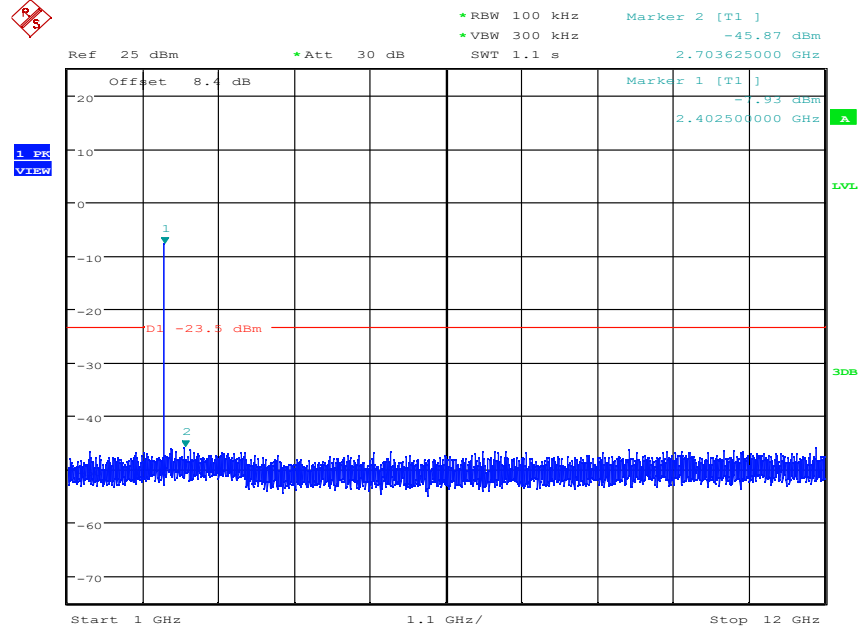

Date: 18.JUN.2020 14:18:09

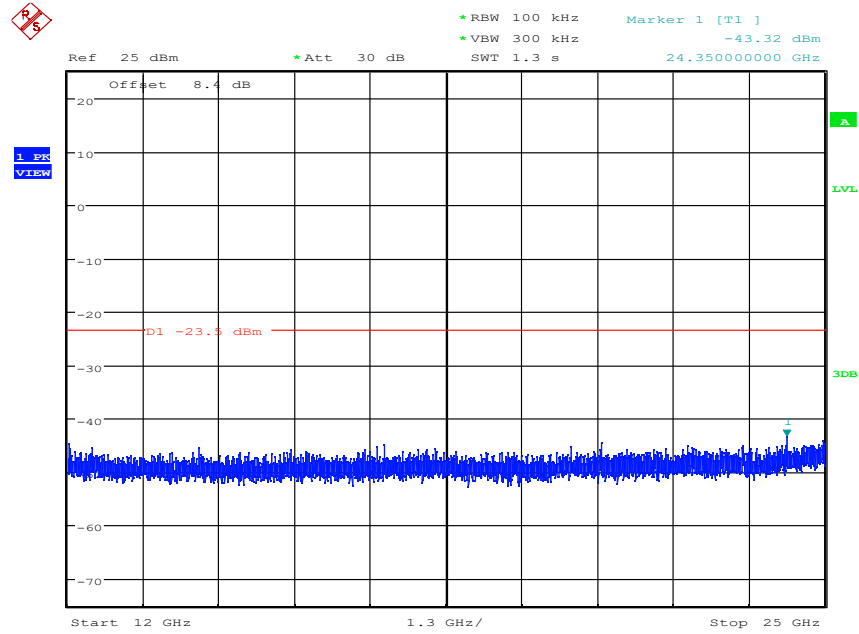

Date: 18.JUN.2020 14:18:22



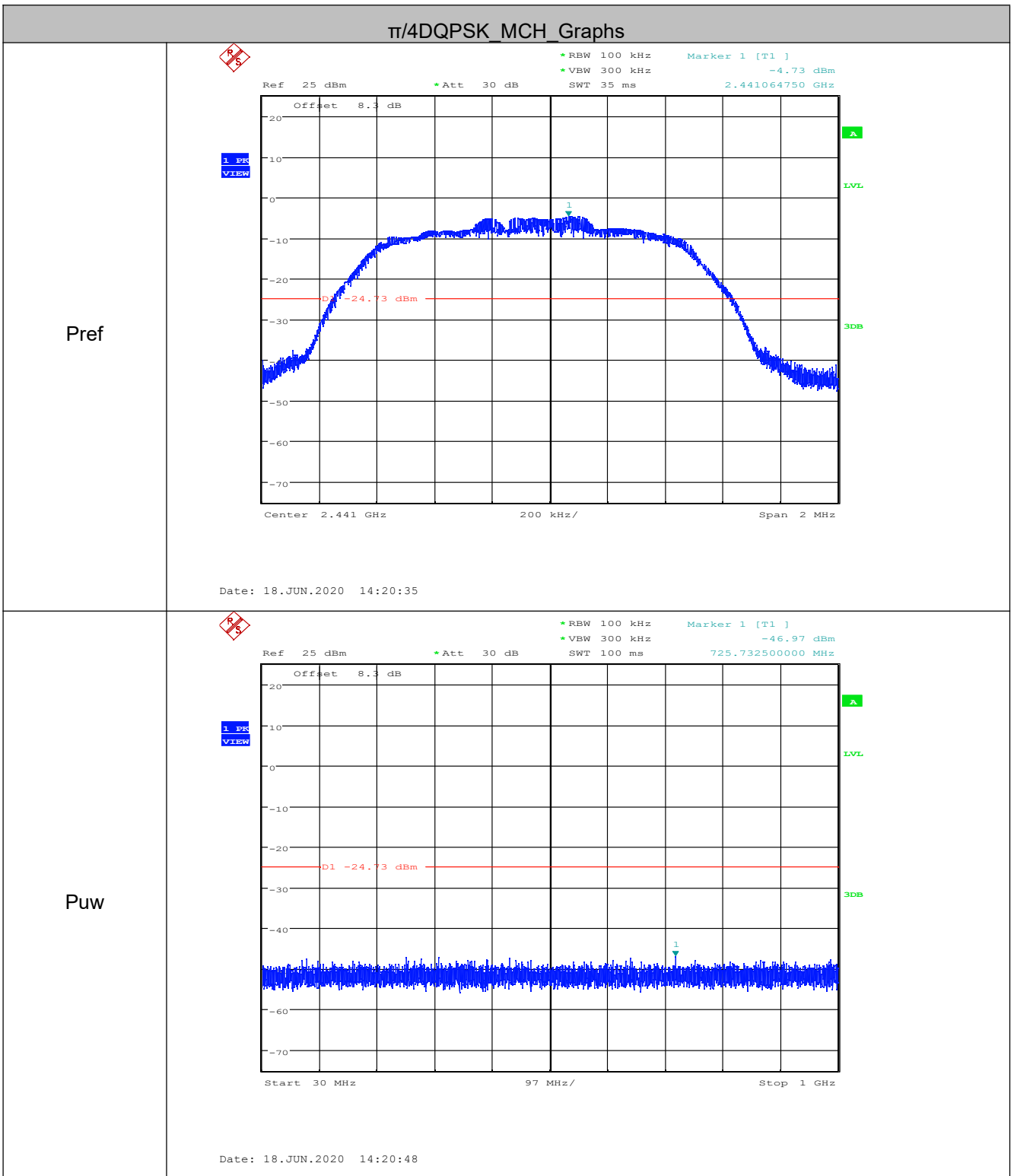

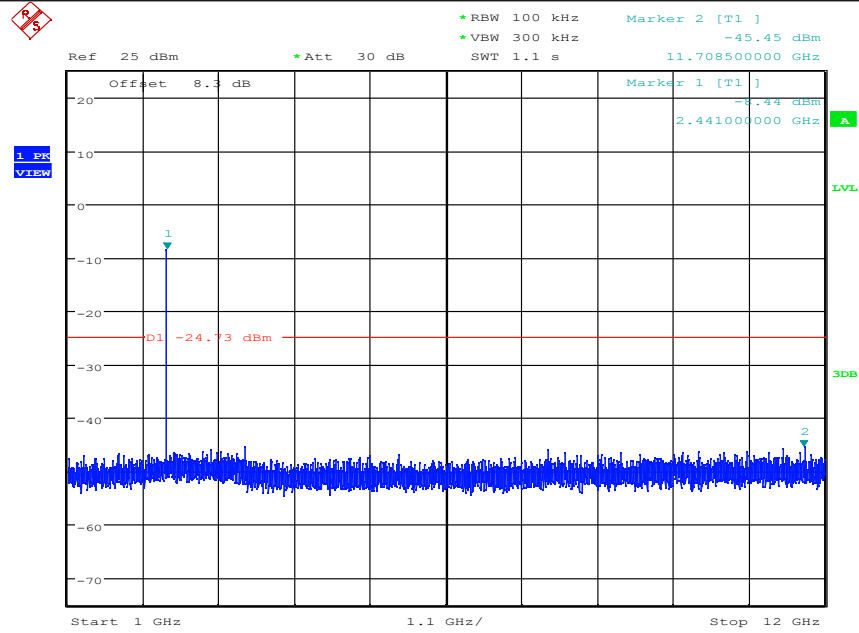

Date: 18.JUN.2020 14:20:59

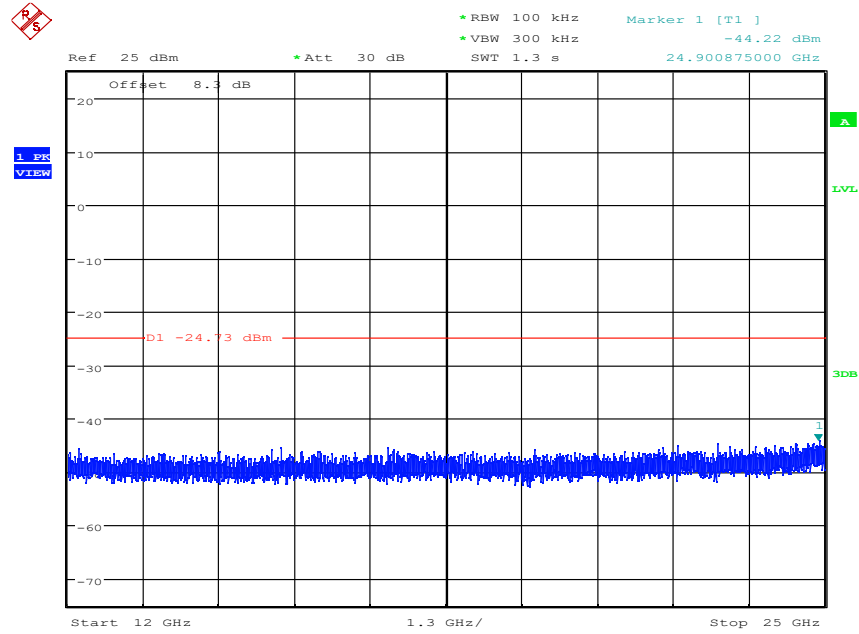

Date: 18.JUN.2020 14:21:12

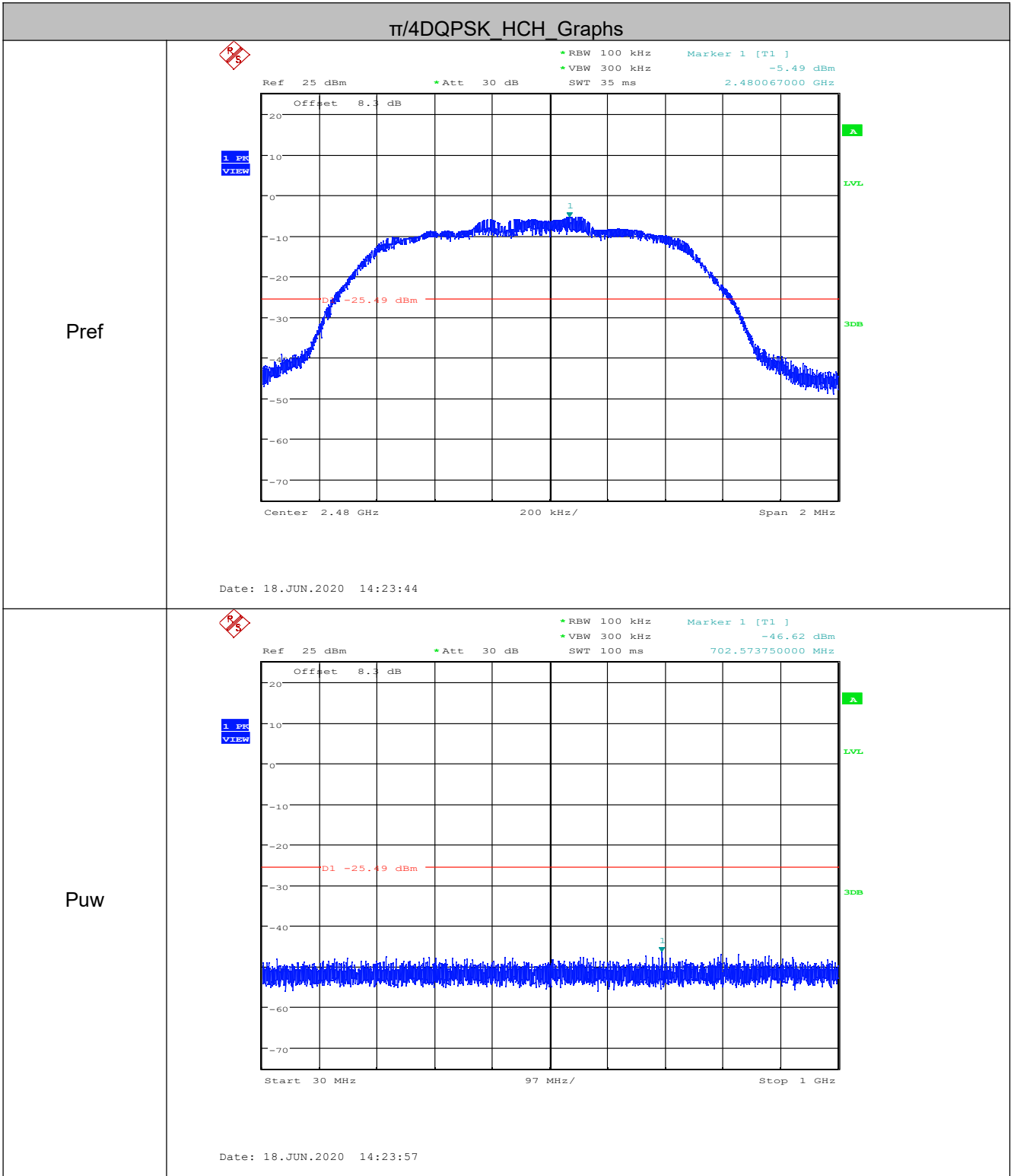

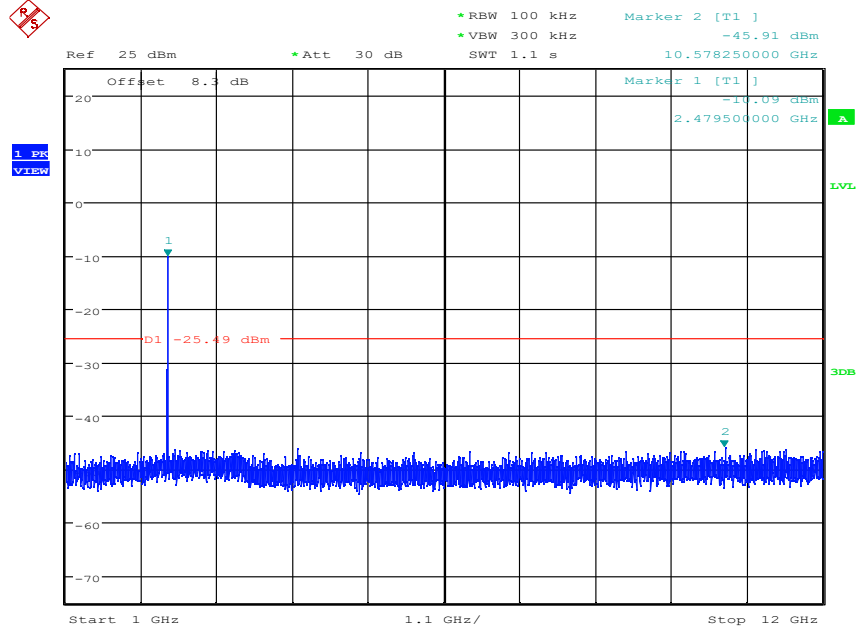

Date: 18.JUN.2020 14:24:08

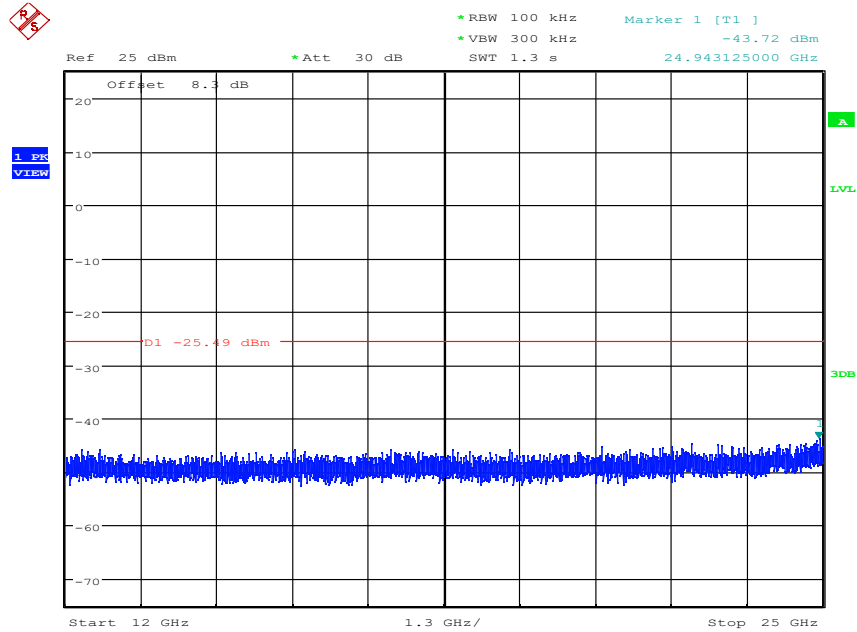

Date: 18.JUN.2020 14:24:21

8DPSK\_LCH\_Graphs

Pref

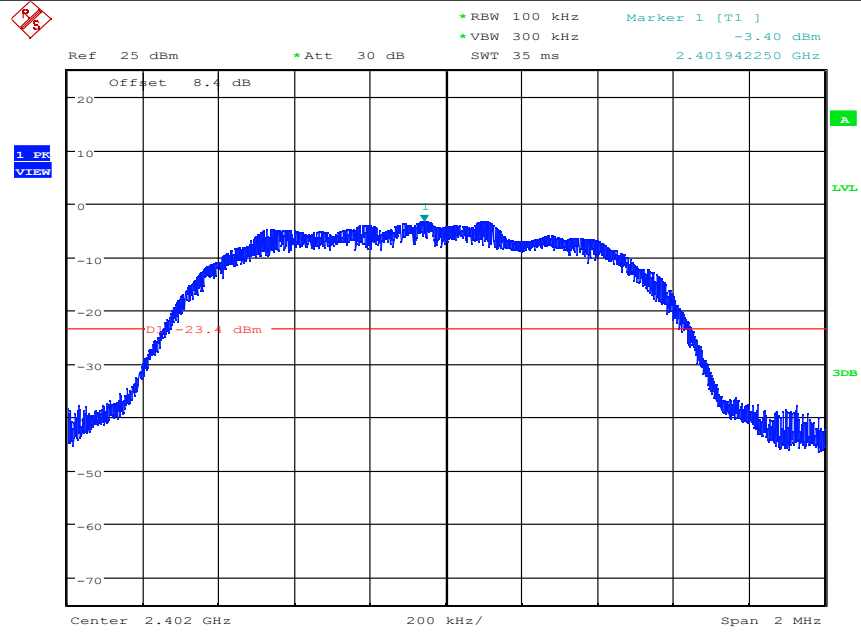

Date: 18.JUN.2020 14:27:08

Puw

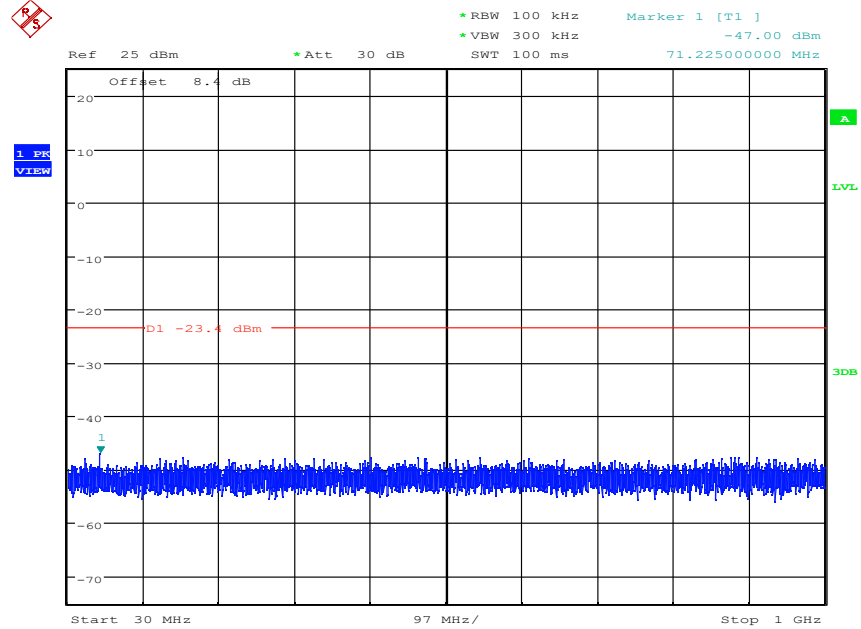

Date: 18.JUN.2020 14:27:22

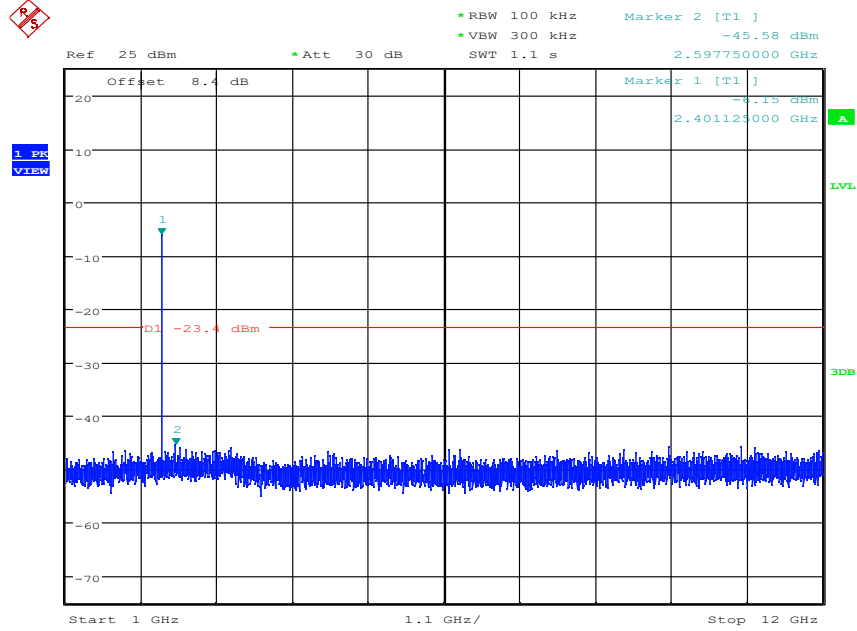

Date: 18.JUN.2020 14:27:32

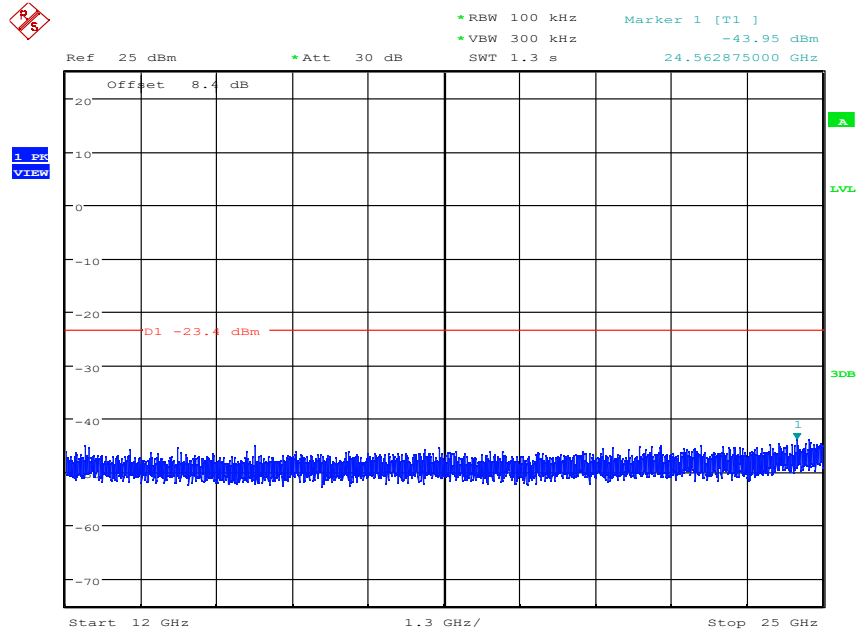

Date: 18.JUN.2020 14:27:45

8DPSK\_MCH\_Graphs

Pref

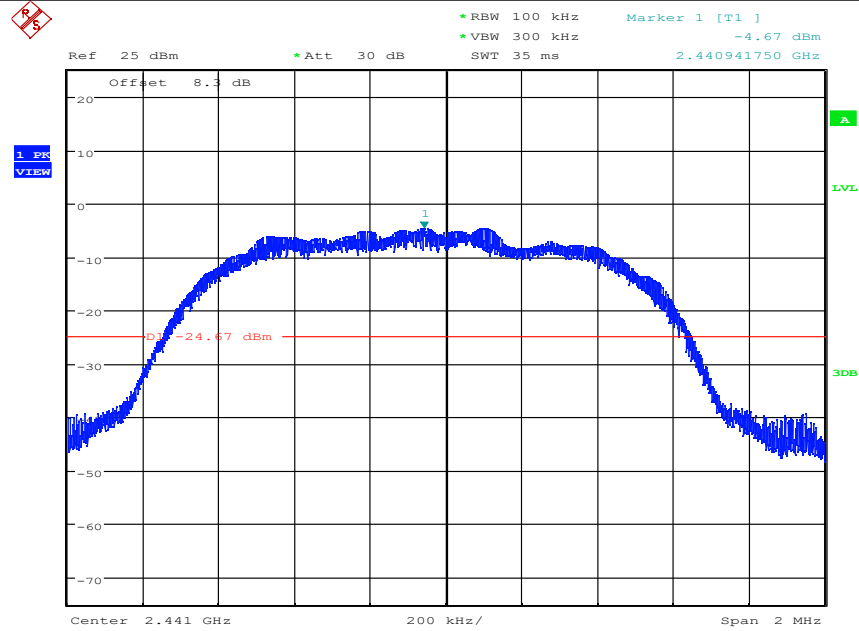

Date: 18.JUN.2020 14:30:04

Puw

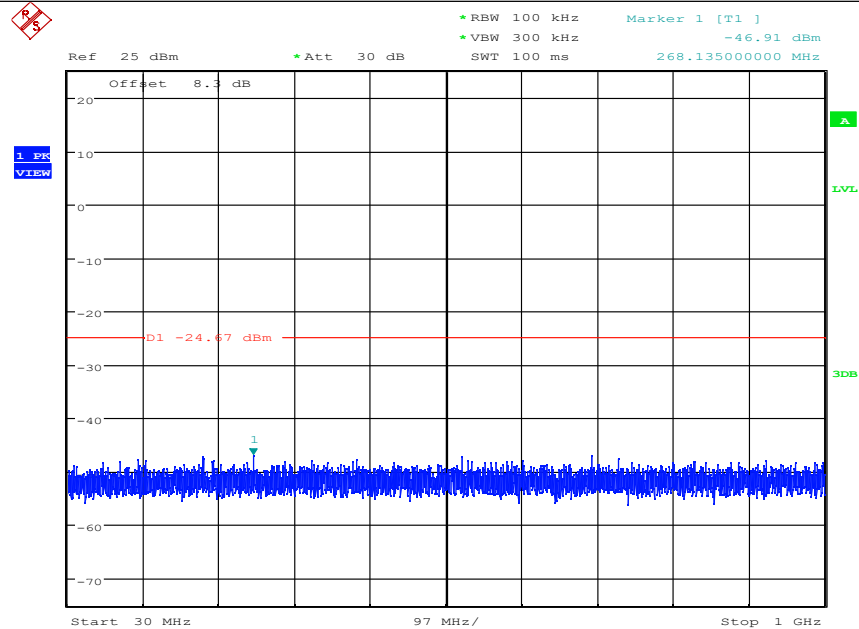

Date: 18.JUN.2020 14:30:17

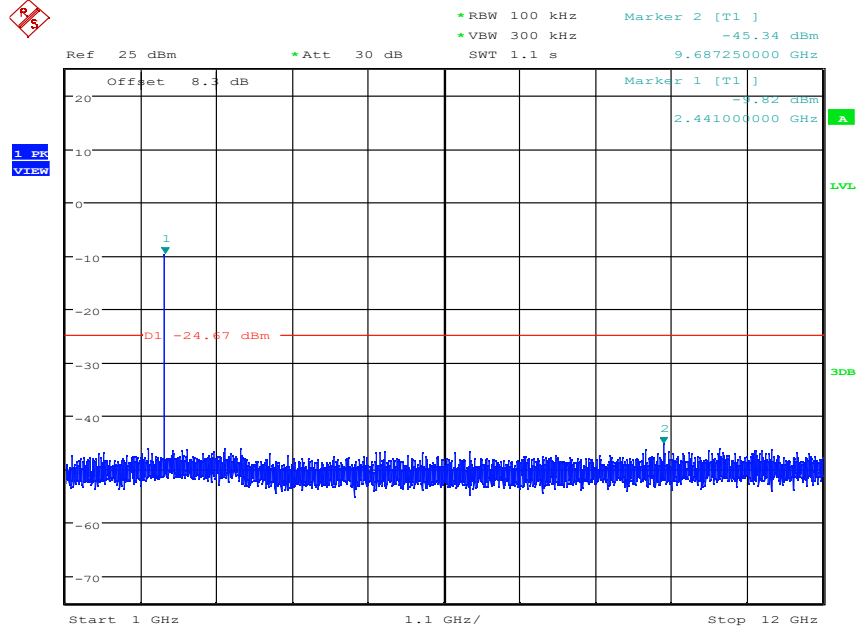

Date: 18.JUN.2020 14:30:28

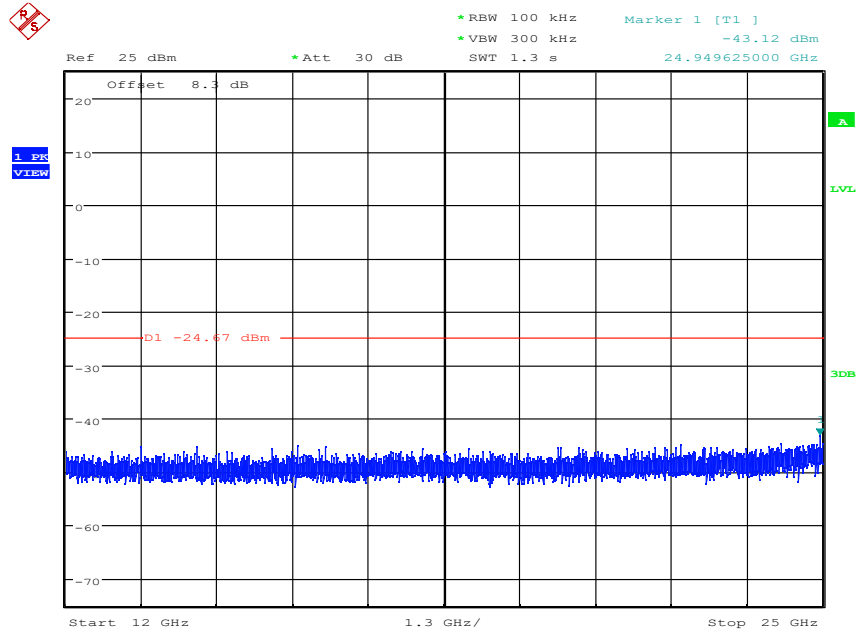

Date: 18.JUN.2020 14:30:40



8DPSK\_HCH\_Graphs

Pref

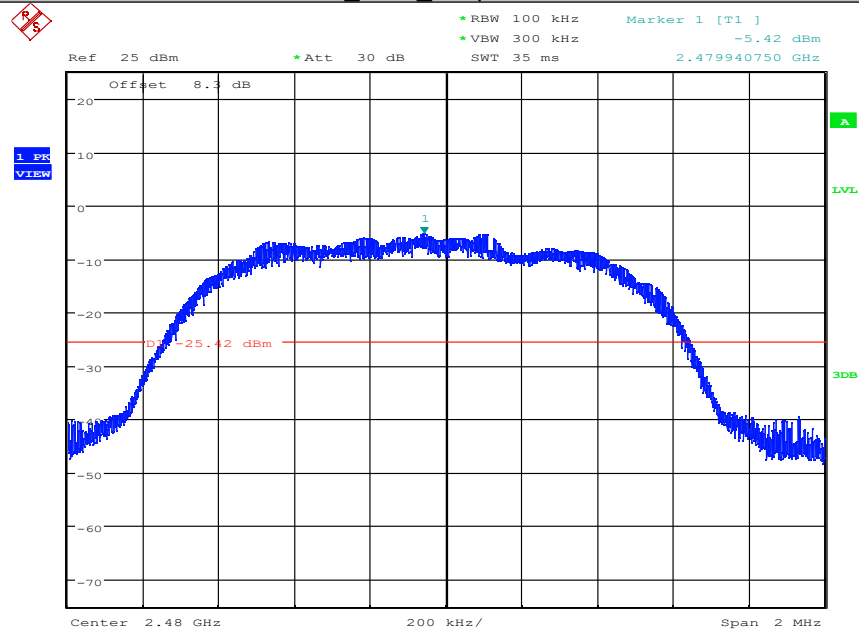

Date: 18.JUN.2020 14:33:33

Puw

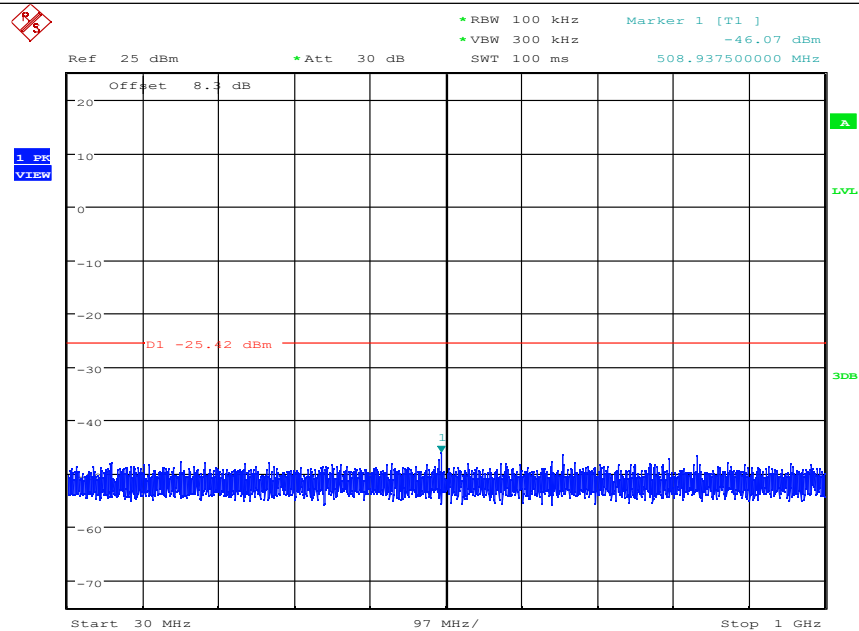

Date: 18.JUN.2020 14:33:46

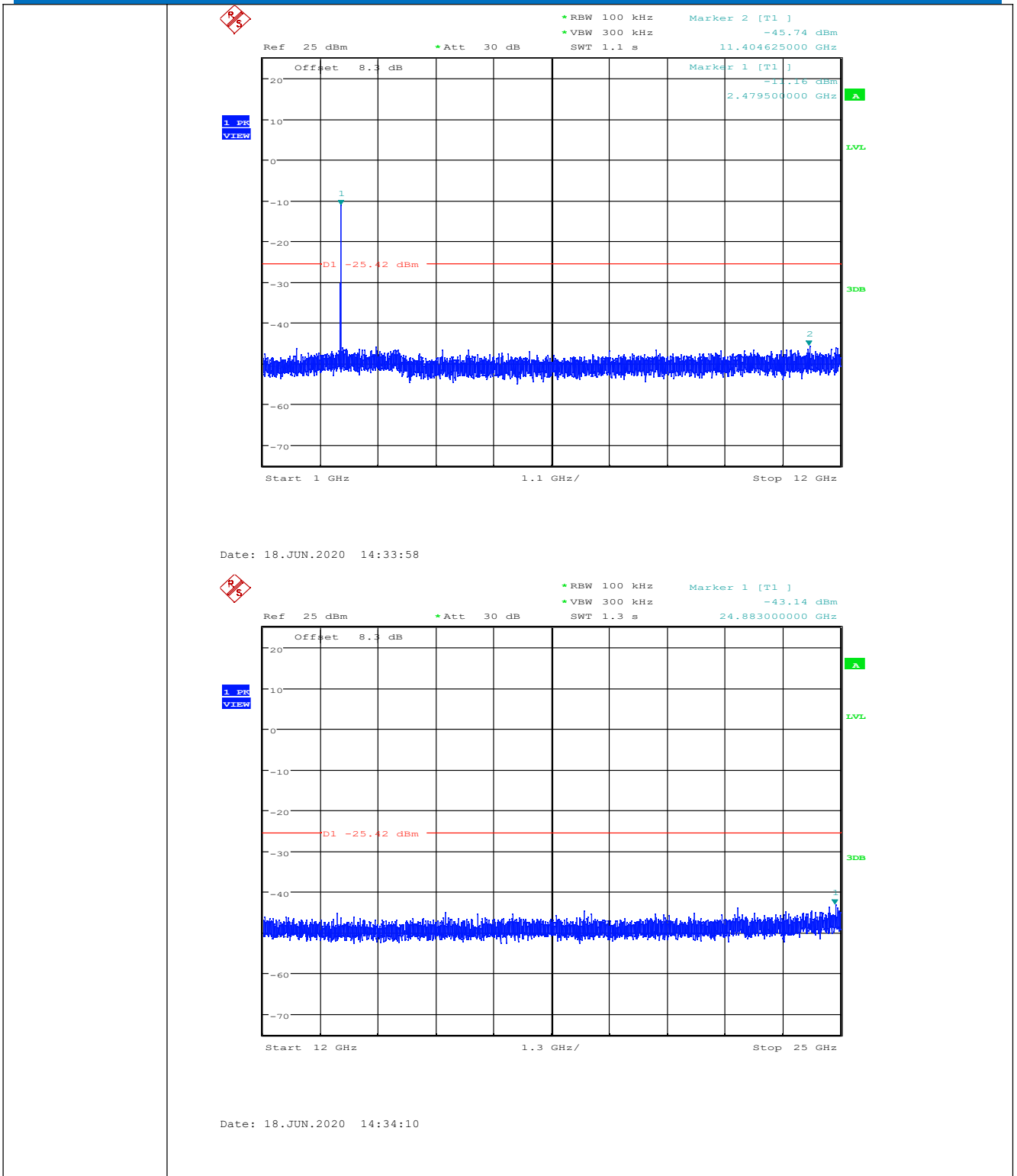

Remark:

Pre test 9kHz to 25GHz, find the highest point when testing, so only the worst data were shown in the test report. Per FCC Part 15.33 (a) and 15.31 (o), The amplitude of spurious emissions from intentional radiators which are attenuated more than 20 dB below the permissible value need not be reported unless specifically required elsewhere in this part.

#### 4.10 Other requirements Frequency Hopping Spread Spectrum System

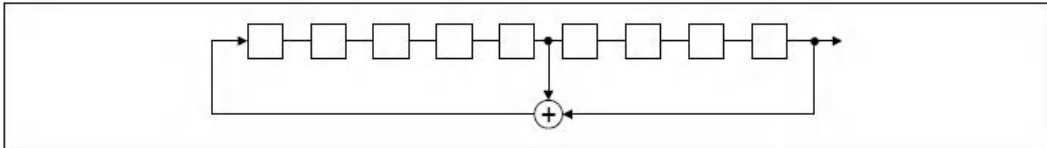
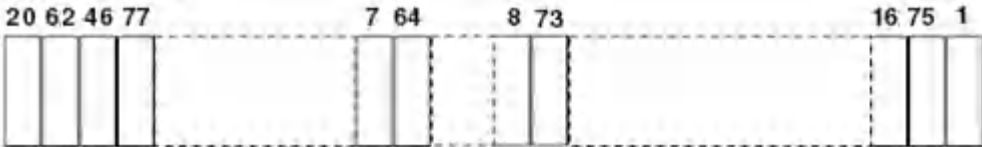
| Test Requirement: | 47 CFR Part 15C Section 15.247 (a)(1), (h) requirement:   |
|-------------------|---|
|                   | <p>The system shall hop to channel frequencies that are selected at the system hopping rate from a Pseudorandom ordered list of hopping frequencies. Each frequency must be used equally on the average by each transmitter. The system receivers shall have input bandwidths that match the hopping channel bandwidths of their corresponding transmitters and shall shift frequencies in synchronization with the transmitted signals.</p> <p>Frequency hopping spread spectrum systems are not required to employ all available hopping channels during each transmission. However, the system, consisting of both the transmitter and the receiver, must be designed to comply with all of the regulations in this section should the transmitter be presented with a continuous data (or information) stream. In addition, a system employing short transmission bursts must comply with the definition of a frequency hopping system and must distribute its transmissions over the minimum number of hopping channels specified in this section.</p> <p>The incorporation of intelligence within a frequency hopping spread spectrum system that permits the system to recognize other users within the spectrum band so that it individually and independently chooses and adapts its hopsets to avoid hopping on occupied channels is permitted. The coordination of frequency hopping systems in any other manner for the express purpose of avoiding the simultaneous occupancy of individual hopping frequencies by multiple transmitters is not permitted.</p> |
|                   | <p><b>Compliance for section 15.247(a)(1)</b></p>   |
|                   | <p>According to Bluetooth Core Specification, the pseudorandom sequence may be generated in a nine-stage shift register whose 5th and 9th stage outputs are added in a modulo-two addition stage. And the result is fed back to the input of the first stage. The sequence begins with the first ONE of 9 consecutive ONES; i.e. the shift register is initialized with nine ones.</p> <ul style="list-style-type: none"> <li>• Number of shift register stages: 9</li> <li>• Length of pseudo-random sequence: <math>2^9 - 1 = 511</math> bits</li> <li>• Longest sequence of zeros: 8 (non-inverted signal)</li> </ul>  <p><i>Linear Feedback Shift Register for Generation of the PRBS sequence</i></p> <p>An example of Pseudorandom Frequency Hopping Sequence as follow:</p>  <p>Each frequency used equally on the average by each transmitter.</p> <p>According to Bluetooth Core Specification, Bluetooth receivers are designed to have input and IF bandwidths that match the hopping channel bandwidths of any Bluetooth transmitters and shift frequencies in synchronization with the transmitted signals.</p>  |
|                   | <p><b>Compliance for section 15.247(g)</b></p>  |
|                   | <p>According to Bluetooth Core Specification, the Bluetooth system transmits the packet with the pseudorandom hopping frequency with a continuous data and the short burst transmission from the Bluetooth system is also transmitted under the frequency hopping system with the pseudorandom hopping frequency system.</p>  |

**Compliance for section 15.247(h)**

According to Bluetooth Core specification, the Bluetooth system incorporates with an adaptive system to detect other user within the spectrum band so that it individually and independently to avoid hopping on the occupied channels.

According to the Bluetooth Core specification, the Bluetooth system is designed not have the ability to coordinated with other FHSS System in an effort to avoid the simultaneous occupancy of individual hopping frequencies by multiple transmitter.

#### 4.11 Radiated Spurious Emission & Restricted bands

|  |  |                                  |                |            |                          |
|--|--|----------------------------------|----------------|------------|--------------------------|
| Test Requirement:  | 47 CFR Part 15C Section 15.209 and 15.205        |                                  |                |            |                          |
| Test Method:   | ANSI C63.10: 2013                                |                                  |                |            |                          |
| Test Site:   | Measurement Distance: 3m (Semi-Anechoic Chamber) |                                  |                |            |                          |
| Receiver Setup:  | Frequency  | Detector                         | RBW            | VBW        | Remark                   |
|  | 0.009MHz-0.090MHz                                | Peak                             | 10kHz          | 30kHz      | Peak                     |
|  | 0.009MHz-0.090MHz                                | Average                          | 10kHz          | 30kHz      | Average                  |
|  | 0.090MHz-0.110MHz                                | Quasi-peak                       | 10kHz          | 30kHz      | Quasi-peak               |
|  | 0.110MHz-0.490MHz                                | Peak                             | 10kHz          | 30kHz      | Peak                     |
|  | 0.110MHz-0.490MHz                                | Average                          | 10kHz          | 30kHz      | Average                  |
|  | 0.490MHz -30MHz                                  | Quasi-peak                       | 10kHz          | 30kHz      | Quasi-peak               |
|  | 30MHz-1GHz                                       | Peak                             | 100 kHz        | 300kHz     | Peak                     |
|  | Above 1GHz                                       | Peak                             | 1MHz           | 3MHz       | Peak                     |
| Peak   |  | 1MHz                             | 10Hz           | Average    |                          |
| Limit:   | Frequency  | Field strength (microvolt/meter) | Limit (dBuV/m) | Remark     | Measurement distance (m) |
|  | 0.009MHz-0.490MHz                                | 2400/F(kHz)                      | -              | -          | 300                      |
|  | 0.490MHz-1.705MHz                                | 24000/F(kHz)                     | -              | -          | 30                       |
|  | 1.705MHz-30MHz                                   | 30                               | -              | -          | 30                       |
|  | 30MHz-88MHz                                      | 100                              | 40.0           | Quasi-peak | 3                        |
|  | 88MHz-216MHz                                     | 150                              | 43.5           | Quasi-peak | 3                        |
|  | 216MHz-960MHz                                    | 200                              | 46.0           | Quasi-peak | 3                        |
|  | 960MHz-1GHz                                      | 500                              | 54.0           | Quasi-peak | 3                        |
|  | Above 1GHz                                       | 500                              | 54.0           | Average    | 3                        |
| <p>Note: 15.35(b), Unless otherwise specified, the limit on peak radio frequency emissions is 20dB above the maximum permitted average emission limit applicable to the equipment under test. This peak limit applies to the total peak emission level radiated by the device.</p> |  |                                  |                |            |                          |

Test Setup:

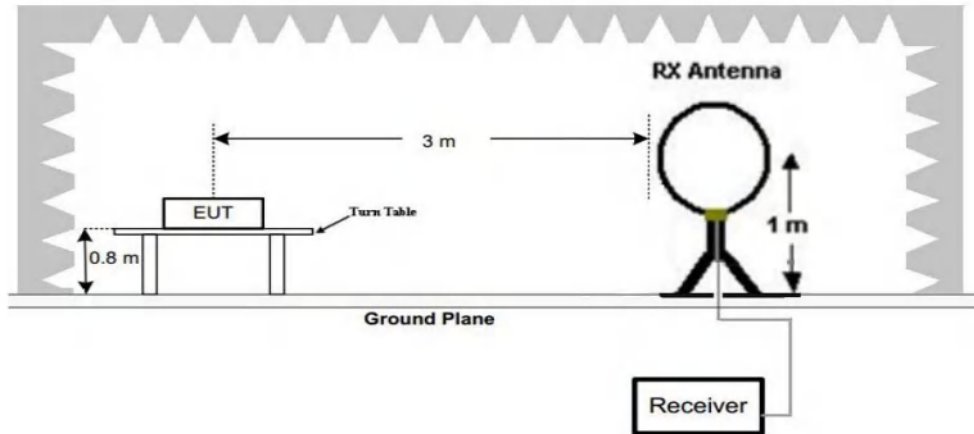

Figure 1. Below 30MHz

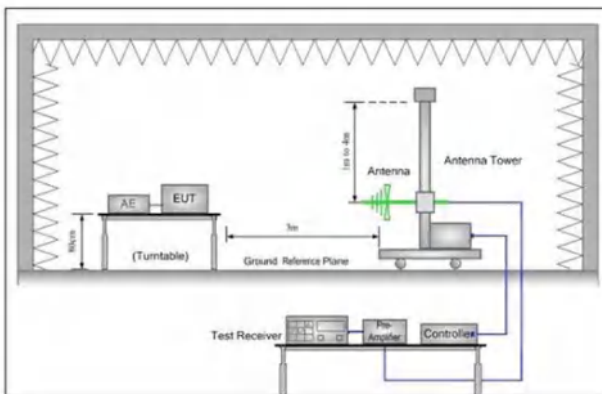

Figure 2. 30MHz to 1GHz

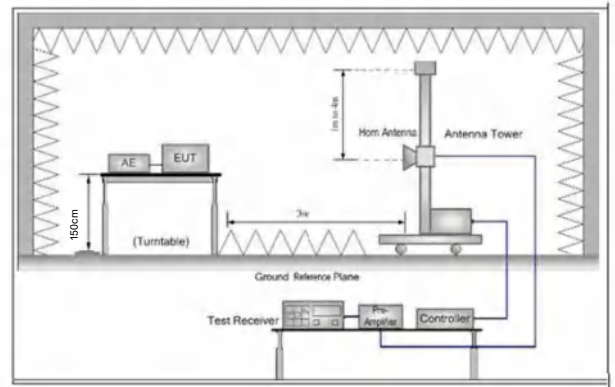

Figure 3. Above 1 GHz

Test Procedure:

- a. 1) Below 1G: The EUT was placed on the top of a rotating table 0.8 meters above the ground at a 3 meter semi-anechoic chamber. The table was rotated 360 degrees to determine the position of the highest radiation.
- 2) Above 1G: The EUT was placed on the top of a rotating table 1.5 meters above the ground at a 3 meter semi-anechoic chamber. The table was rotated 360 degrees to determine the position of the highest radiation.
- Note: For the radiated emission test above 1GHz:  
Place the measurement antenna away from each area of the EUT determined to be a source of emissions at the specified measurement distance, while keeping the measurement antenna aimed at the source of emissions at each frequency of significant emissions, with polarization oriented for maximum response. The measurement antenna may have to be higher or lower than the EUT, depending on the radiation pattern of the emission and staying aimed at the emission source for receiving the maximum signal. The final measurement antenna elevation shall be that which maximizes the emissions. The measurement antenna elevation for maximum emissions shall be restricted to a range of heights of from 1 m to 4 m above the ground or reference ground plane.
- b. The EUT was set 3 meters away from the interference-receiving antenna, which was mounted on the top of a variable-height antenna tower.
- c. The antenna height is varied from one meter to four meters above the ground to determine the maximum value of the field strength. Both horizontal and vertical polarizations of the antenna are set to make the measurement.

|                        |   |
|------------------------|---|
|                        | <p>d. For each suspected emission, the EUT was arranged to its worst case and then the antenna was tuned to heights from 1 meter to 4 meters (for the test frequency of below 30MHz, the antenna was tuned to heights 1 meter) and the rotatable table was turned from 0 degrees to 360 degrees to find the maximum reading.</p> <p>e. The test-receiver system was set to Peak Detect Function and Specified Bandwidth with Maximum Hold Mode.</p> <p>f. If the emission level of the EUT in peak mode was 10dB lower than the limit specified, then testing could be stopped and the peak values of the EUT would be reported. Otherwise the emissions that did not have 10dB margin would be re-tested one by one using peak, quasi-peak or average method as specified and then reported in a data sheet.</p> <p>g. Test the EUT in the lowest channel (2402MHz),the middle channel (2441MHz),the Highest channel (2480MHz)</p> <p>h. The radiation measurements are performed in X, Y, Z axis positioning for Transmitting mode, and found the X axis positioning which it is the worst case.</p> <p>i. Repeat above procedures until all frequencies measured was complete.</p> |
| Exploratory Test Mode: | <p>Non-hopping transmitting mode with all kind of modulation and all kind of data type<br/>Transmitting mode.</p>   |
| Final Test Mode:       | <p>Through Pre-scan, find the 3DH5 of data type and 8DPSK modulation is the worst case.<br/>For below 1GHz part, through pre-scan, the worst case is the lowest channel.<br/>Only the worst case is recorded in the report.</p>   |
| Test Results:          | <p>Pass</p>   |

### 4.11.1 Radiated Emission below 1GHz

|            |              |          |
|------------|--------------|----------|
| 30MHz~1GHz |              |          |
| Test mode: | Transmitting | Vertical |

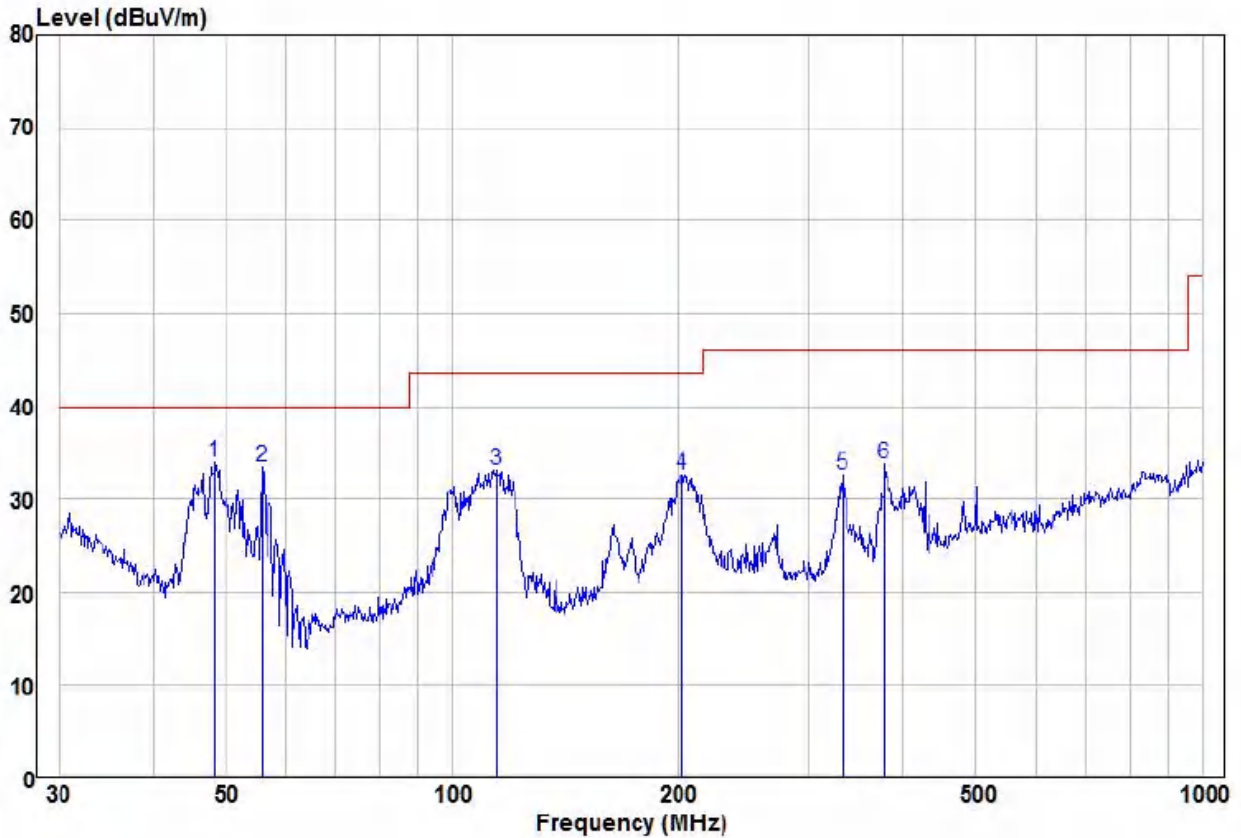

|      | Read Freq | Read Level | Factor | Level  | Limit Line | Over Limit | Remark | Pol/Phase |
|------|-----------|------------|--------|--------|------------|------------|--------|-----------|
|      | MHz       | dBuV       | dB/m   | dBuV/m | dBuV/m     | dB         |        |           |
| 1 pp | 48.33     | 25.02      | 8.87   | 33.89  | 40.00      | -6.11      | Peak   | VERTICAL  |
| 2    | 55.80     | 26.68      | 6.73   | 33.41  | 40.00      | -6.59      | Peak   | VERTICAL  |
| 3    | 114.51    | 22.70      | 10.41  | 33.11  | 43.50      | -10.39     | Peak   | VERTICAL  |
| 4    | 202.81    | 24.08      | 8.58   | 32.66  | 43.50      | -10.84     | Peak   | VERTICAL  |
| 5    | 331.35    | 18.16      | 14.49  | 32.65  | 46.00      | -13.35     | Peak   | VERTICAL  |
| 6    | 377.26    | 19.15      | 14.61  | 33.76  | 46.00      | -12.24     | Peak   | VERTICAL  |

Remark:

The field strength is calculated by adding the Antenna Factor, Cable Factor & Preamplifier. The basic equation with a sample calculation is as follows:

Factor= Antenna Factor + Cable Factor – Preamplifier Factor,

Level = Read Level + Factor,

Over Limit=Level-Limit Line.



|            |              |            |
|------------|--------------|------------|
| Test mode: | Transmitting | Horizontal |
|------------|--------------|------------|

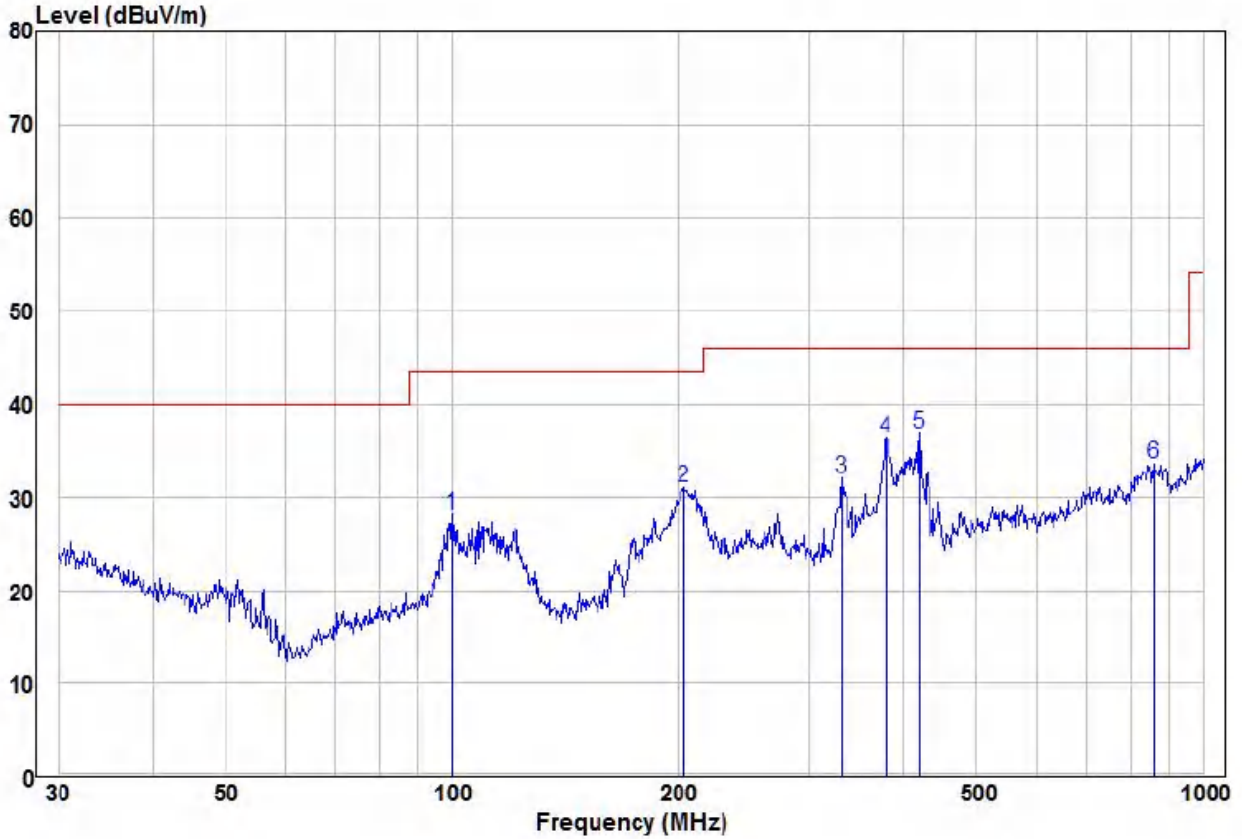

|      | Read Freq | Read Level | Factor | Level  | Limit  | Over   | Remark | Pol/Phase  |
|------|-----------|------------|--------|--------|--------|--------|--------|------------|
|      | MHz       | dBuV       | dB/m   | dBuV/m | dBuV/m | dB     |        |            |
| 1    | 100.23    | 17.51      | 10.64  | 28.15  | 43.50  | -15.35 | Peak   | HORIZONTAL |
| 2    | 204.24    | 22.49      | 8.62   | 31.11  | 43.50  | -12.39 | Peak   | HORIZONTAL |
| 3    | 330.19    | 17.56      | 14.46  | 32.02  | 46.00  | -13.98 | Peak   | HORIZONTAL |
| 4    | 378.58    | 21.66      | 14.64  | 36.30  | 46.00  | -9.70  | Peak   | HORIZONTAL |
| 5 pp | 419.11    | 21.12      | 15.75  | 36.87  | 46.00  | -9.13  | Peak   | HORIZONTAL |
| 6    | 860.04    | 9.62       | 24.01  | 33.63  | 46.00  | -12.37 | Peak   | HORIZONTAL |

Remark:

The field strength is calculated by adding the Antenna Factor, Cable Factor & Preamplifier. The basic equation with a sample calculation is as follows:

Factor= Antenna Factor + Cable Factor – Preamplifier Factor,

Level = Read Level + Factor,

Over Limit=Level-Limit Line.

#### 4.11.2 Transmitter Emission above 1GHz

| Worse case mode: |               | GFSK(DH5)   |                | Test channel:  |               | Lowest        |           |
|------------------|---------------|-------------|----------------|----------------|---------------|---------------|-----------|
| Frequency        | Meter Reading | Factor      | Emission Level | Limits         | Over          | Detector Type | Ant. Pol. |
| (MHz)            | (dB $\mu$ V)  | (dB)        | (dB $\mu$ V/m) | (dB $\mu$ V/m) | (dB)          |               | H/V       |
| <b>2390</b>      | <b>53.49</b>  | <b>-9.2</b> | <b>44.29</b>   | <b>74</b>      | <b>-29.71</b> | <b>Peak</b>   | <b>H</b>  |
| 2400             | 56.45         | -9.39       | 47.06          | 74             | -26.94        | Peak          | H         |
| 4804             | 53.41         | -4.33       | 49.08          | 74             | -24.92        | Peak          | H         |
| 7206             | 49.43         | 1.01        | 50.44          | 74             | -23.56        | Peak          | H         |
| <b>2390</b>      | <b>55.66</b>  | <b>-9.2</b> | <b>46.46</b>   | <b>74</b>      | <b>-27.54</b> | <b>Peak</b>   | <b>V</b>  |
| 2400             | 55.56         | -9.39       | 46.17          | 74             | -27.83        | Peak          | V         |
| 4804             | 53.36         | -4.33       | 49.03          | 74             | -24.97        | Peak          | V         |
| 7206             | 50.11         | 1.01        | 51.12          | 74             | -22.88        | Peak          | V         |

| Worse case mode: |               | GFSK(DH5) |                | Test channel:  |        | Middle        |           |
|------------------|---------------|-----------|----------------|----------------|--------|---------------|-----------|
| Frequency        | Meter Reading | Factor    | Emission Level | Limits         | Over   | Detector Type | Ant. Pol. |
| (MHz)            | (dB $\mu$ V)  | (dB)      | (dB $\mu$ V/m) | (dB $\mu$ V/m) | (dB)   |               | H/V       |
| 4882             | 53.20         | -4.11     | 49.09          | 74             | -24.91 | peak          | H         |
| 7323             | 50.41         | 1.51      | 51.92          | 74             | -22.08 | peak          | H         |
| 4882             | 53.52         | -4.11     | 49.41          | 74             | -24.59 | peak          | V         |
| 7323             | 50.21         | 1.51      | 51.72          | 74             | -22.28 | peak          | V         |

| Worse case mode: |               | GFSK(DH5)    |                | Test channel:  |               | Highest       |           |
|------------------|---------------|--------------|----------------|----------------|---------------|---------------|-----------|
| Frequency        | Meter Reading | Factor       | Emission Level | Limits         | Over          | Detector Type | Ant. Pol. |
| (MHz)            | (dB $\mu$ V)  | (dB)         | (dB $\mu$ V/m) | (dB $\mu$ V/m) | (dB)          |               | H/V       |
| <b>2483.5</b>    | <b>54.49</b>  | <b>-9.29</b> | <b>45.20</b>   | <b>74</b>      | <b>-28.80</b> | <b>Peak</b>   | <b>H</b>  |
| 4960             | 52.65         | -4.04        | 48.61          | 74             | -25.39        | Peak          | H         |
| 7440             | 49.74         | 1.57         | 51.31          | 74             | -22.69        | Peak          | H         |
| <b>2483.5</b>    | <b>54.06</b>  | <b>-9.29</b> | <b>44.77</b>   | <b>74</b>      | <b>-29.23</b> | <b>Peak</b>   | <b>V</b>  |
| 4960             | 49.30         | -4.04        | 45.26          | 74             | -28.74        | Peak          | V         |
| 7440             | 49.79         | 1.57         | 51.36          | 74             | -22.64        | Peak          | V         |

| Worse case mode: |               | $\pi/4$ DQPSK(2DH5) |                | Test channel:  |               | Lowest        |           |
|------------------|---------------|---------------------|----------------|----------------|---------------|---------------|-----------|
| Frequency        | Meter Reading | Factor              | Emission Level | Limits         | Over          | Detector Type | Ant. Pol. |
| (MHz)            | (dB $\mu$ V)  | (dB)                | (dB $\mu$ V/m) | (dB $\mu$ V/m) | (dB)          |               | H/V       |
| <b>2390</b>      | <b>54.45</b>  | <b>-9.2</b>         | <b>45.25</b>   | <b>74</b>      | <b>-28.75</b> | <b>Peak</b>   | <b>H</b>  |
| 2400             | 55.34         | -9.39               | 45.95          | 74             | -28.05        | Peak          | H         |
| 4804             | 52.87         | -4.33               | 48.54          | 74             | -25.46        | Peak          | H         |
| 7206             | 51.05         | 1.01                | 52.06          | 74             | -21.94        | Peak          | H         |
| <b>2390</b>      | <b>54.86</b>  | <b>-9.2</b>         | <b>45.66</b>   | <b>74</b>      | <b>-28.34</b> | <b>Peak</b>   | <b>V</b>  |
| 2400             | 55.40         | -9.39               | 46.01          | 74             | -27.99        | Peak          | V         |
| 4804             | 55.18         | -4.33               | 50.85          | 74             | -23.15        | Peak          | V         |
| 7206             | 48.56         | 1.01                | 49.57          | 74             | -24.43        | Peak          | V         |

| Worse case mode: |               | $\pi/4$ DQPSK(2DH5) |                | Test channel:  |        | Middle        |           |
|------------------|---------------|---------------------|----------------|----------------|--------|---------------|-----------|
| Frequency        | Meter Reading | Factor              | Emission Level | Limits         | Over   | Detector Type | Ant. Pol. |
| (MHz)            | (dB $\mu$ V)  | (dB)                | (dB $\mu$ V/m) | (dB $\mu$ V/m) | (dB)   |               | H/V       |
| 4882             | 52.03         | -4.11               | 47.92          | 74             | -26.08 | peak          | H         |
| 7323             | 49.50         | 1.51                | 51.01          | 74             | -22.99 | peak          | H         |
| 4882             | 52.63         | -4.11               | 48.52          | 74             | -25.48 | peak          | V         |
| 7323             | 51.06         | 1.51                | 52.57          | 74             | -21.43 | peak          | V         |

| Worse case mode: |               | $\pi/4$ DQPSK(2DH5) |                | Test channel:  |               | Highest       |           |
|------------------|---------------|---------------------|----------------|----------------|---------------|---------------|-----------|
| Frequency        | Meter Reading | Factor              | Emission Level | Limits         | Over          | Detector Type | Ant. Pol. |
| (MHz)            | (dB $\mu$ V)  | (dB)                | (dB $\mu$ V/m) | (dB $\mu$ V/m) | (dB)          |               | H/V       |
| <b>2483.5</b>    | <b>56.33</b>  | <b>-9.29</b>        | <b>47.04</b>   | <b>74</b>      | <b>-26.96</b> | <b>Peak</b>   | <b>H</b>  |
| 4960             | 51.36         | -4.04               | 47.32          | 74             | -26.68        | Peak          | H         |
| 7440             | 51.15         | 1.57                | 52.72          | 74             | -21.28        | Peak          | H         |
| <b>2483.5</b>    | <b>53.68</b>  | <b>-9.29</b>        | <b>44.39</b>   | <b>74</b>      | <b>-29.61</b> | <b>Peak</b>   | <b>V</b>  |
| 4960             | 49.39         | -4.04               | 45.35          | 74             | -28.65        | Peak          | V         |
| 7440             | 49.87         | 1.57                | 51.44          | 74             | -22.56        | Peak          | V         |

| Worse case mode: |               | 8DPSK(3DH5) |                | Test channel:  |               | Lowest        |           |
|------------------|---------------|-------------|----------------|----------------|---------------|---------------|-----------|
| Frequency        | Meter Reading | Factor      | Emission Level | Limits         | Over          | Detector Type | Ant. Pol. |
| (MHz)            | (dB $\mu$ V)  | (dB)        | (dB $\mu$ V/m) | (dB $\mu$ V/m) | (dB)          |               | H/V       |
| <b>2390</b>      | <b>55.90</b>  | <b>-9.2</b> | <b>46.70</b>   | <b>74</b>      | <b>-27.30</b> | <b>Peak</b>   | <b>H</b>  |
| 2400             | 56.40         | -9.39       | 47.01          | 74             | -26.99        | Peak          | H         |
| 4804             | 51.71         | -4.33       | 47.38          | 74             | -26.62        | Peak          | H         |
| 7206             | 50.24         | 1.01        | 51.25          | 74             | -22.75        | Peak          | H         |
| <b>2390</b>      | <b>53.31</b>  | <b>-9.2</b> | <b>44.11</b>   | <b>74</b>      | <b>-29.89</b> | <b>Peak</b>   | <b>V</b>  |
| 2400             | 57.23         | -9.39       | 47.84          | 74             | -26.16        | Peak          | V         |
| 4804             | 54.73         | -4.33       | 50.40          | 74             | -23.60        | Peak          | V         |
| 7206             | 50.43         | 1.01        | 51.44          | 74             | -22.56        | Peak          | V         |

| Worse case mode: |               | 8DPSK(3DH5) |                | Test channel:  |        | Middle        |           |
|------------------|---------------|-------------|----------------|----------------|--------|---------------|-----------|
| Frequency        | Meter Reading | Factor      | Emission Level | Limits         | Over   | Detector Type | Ant. Pol. |
| (MHz)            | (dB $\mu$ V)  | (dB)        | (dB $\mu$ V/m) | (dB $\mu$ V/m) | (dB)   |               | H/V       |
| 4882             | 51.26         | -4.11       | 47.15          | 74             | -26.85 | peak          | H         |
| 7323             | 49.45         | 1.51        | 50.96          | 74             | -23.04 | peak          | H         |
| 4882             | 51.56         | -4.11       | 47.45          | 74             | -26.55 | peak          | V         |
| 7323             | 50.56         | 1.51        | 52.07          | 74             | -21.93 | peak          | V         |

| Worse case mode: |               | 8DPSK(3DH5)  |                | Test channel:  |               | Highest       |           |
|------------------|---------------|--------------|----------------|----------------|---------------|---------------|-----------|
| Frequency        | Meter Reading | Factor       | Emission Level | Limits         | Over          | Detector Type | Ant. Pol. |
| (MHz)            | (dB $\mu$ V)  | (dB)         | (dB $\mu$ V/m) | (dB $\mu$ V/m) | (dB)          |               | H/V       |
| <b>2483.5</b>    | <b>56.32</b>  | <b>-9.29</b> | <b>47.03</b>   | <b>74</b>      | <b>-26.97</b> | <b>Peak</b>   | <b>H</b>  |
| 4960             | 52.51         | -4.04        | 48.47          | 74             | -25.53        | Peak          | H         |
| 7440             | 50.81         | 1.57         | 52.38          | 74             | -21.62        | Peak          | H         |
| <b>2483.5</b>    | <b>54.19</b>  | <b>-9.29</b> | <b>44.90</b>   | <b>74</b>      | <b>-29.10</b> | <b>Peak</b>   | <b>V</b>  |
| 4960             | 49.42         | -4.04        | 45.38          | 74             | -28.62        | Peak          | V         |
| 7440             | 50.71         | 1.57         | 52.28          | 74             | -21.72        | Peak          | V         |

Remark:

- The field strength is calculated by adding the Antenna Factor, Cable Factor & Preamplifier. The basic equation with a sample calculation is as follows:  
Final Test Level = Receiver Reading + Antenna Factor + Cable Factor – Preamplifier Factor
- Scan from 9kHz to 25GHz, the disturbance above 10GHz and below 30MHz was very low. As shown in this section, for frequencies above 1GHz, the field strength limits are based on average limits. However, the peak field strength of any emission shall not exceed the maximum permitted average limits specified above by more than 20 dB under any condition of modulation. So, only the peak measurements were shown in the report.

## 5 Photographs - EUT Test Setup

### 5.1 Radiated Emission

9kHz~30MHz:



30MHz~1GHz:

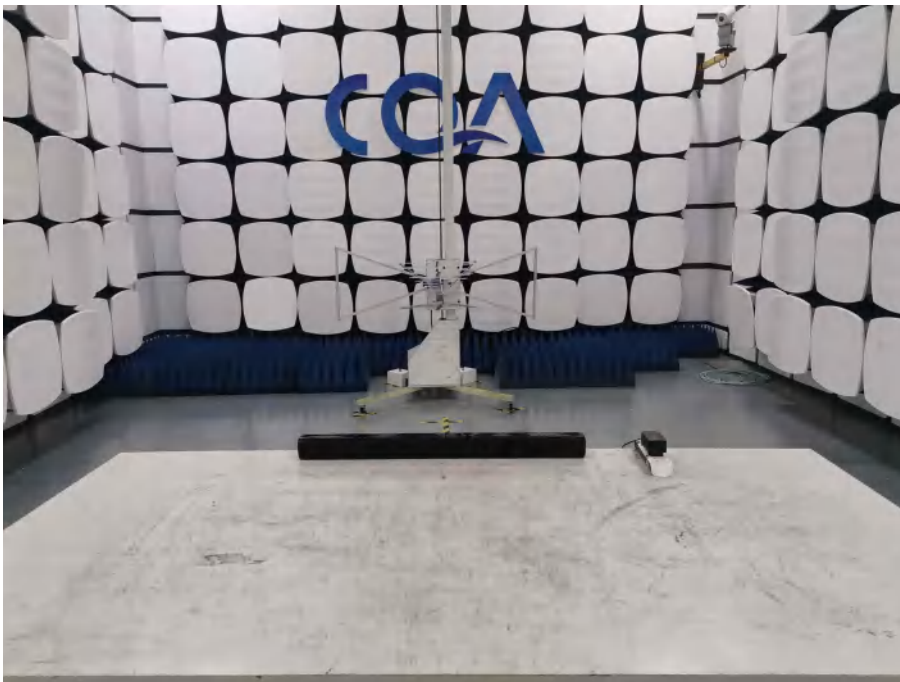

Above 1GHz:

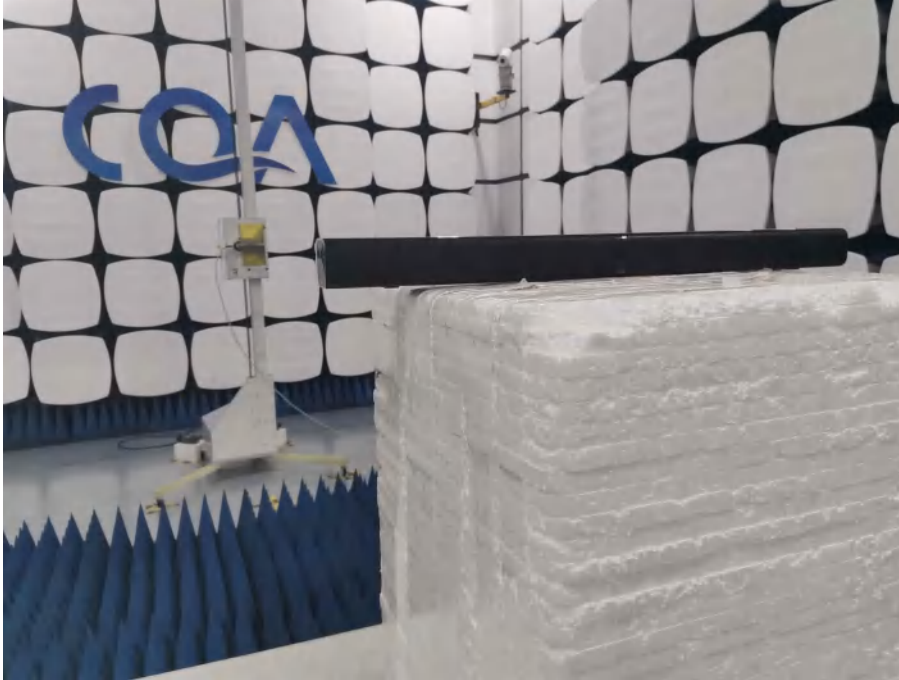

## 5.2 Conducted Emission



## 6 Photographs - EUT Constructional Details

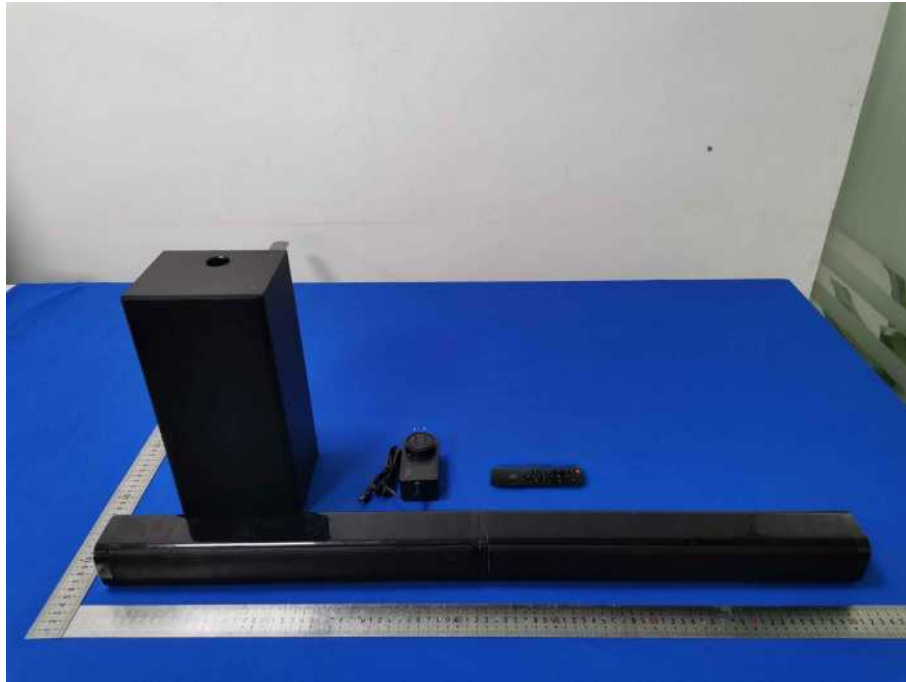

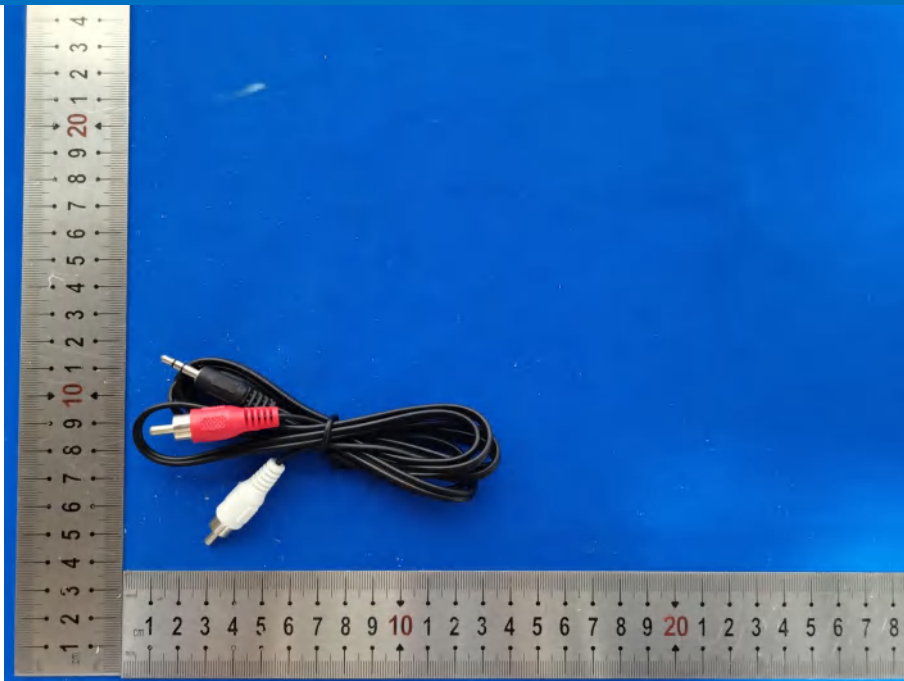







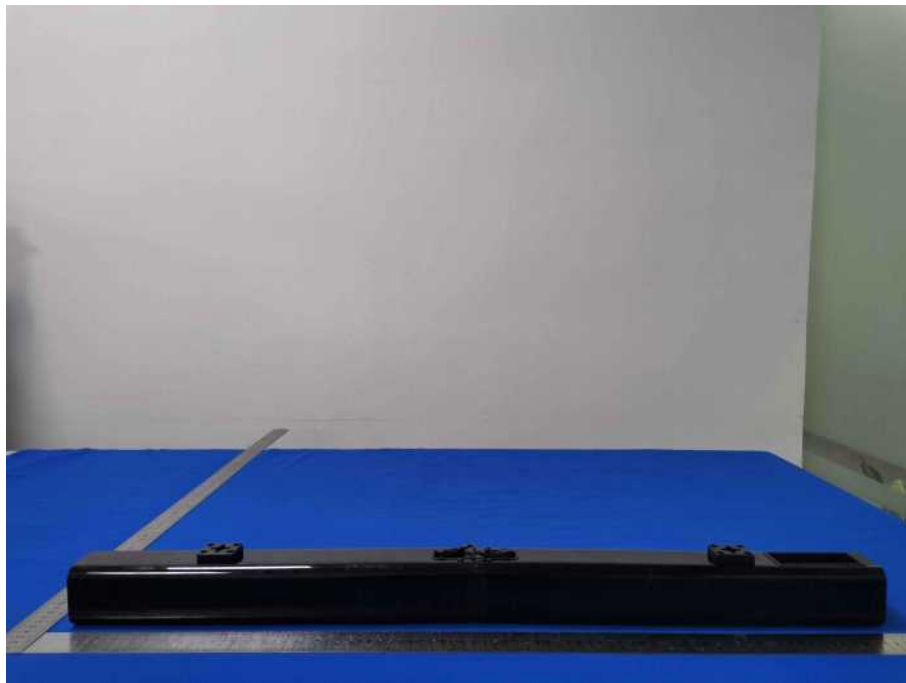





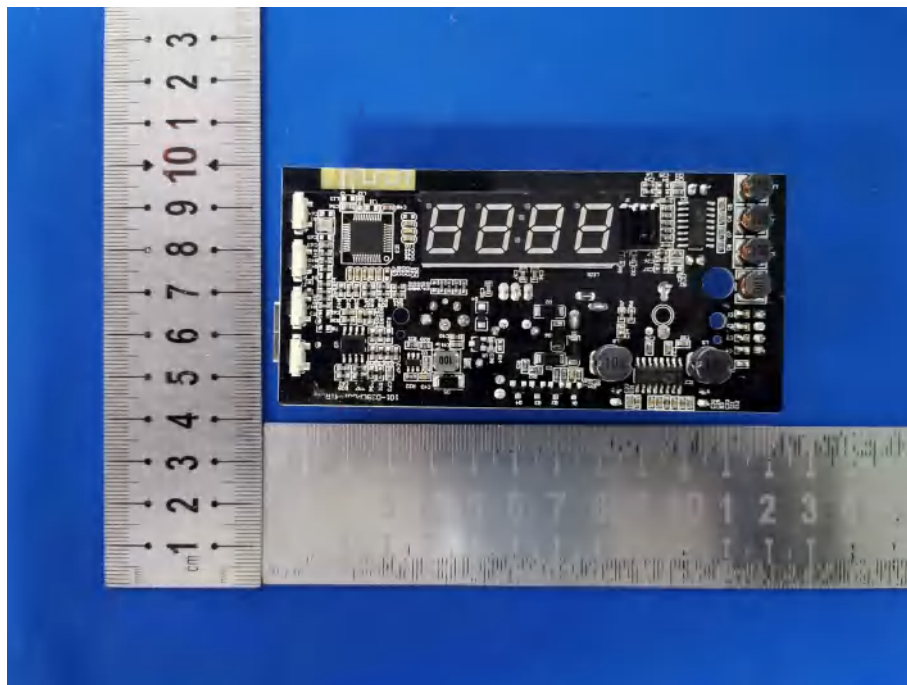

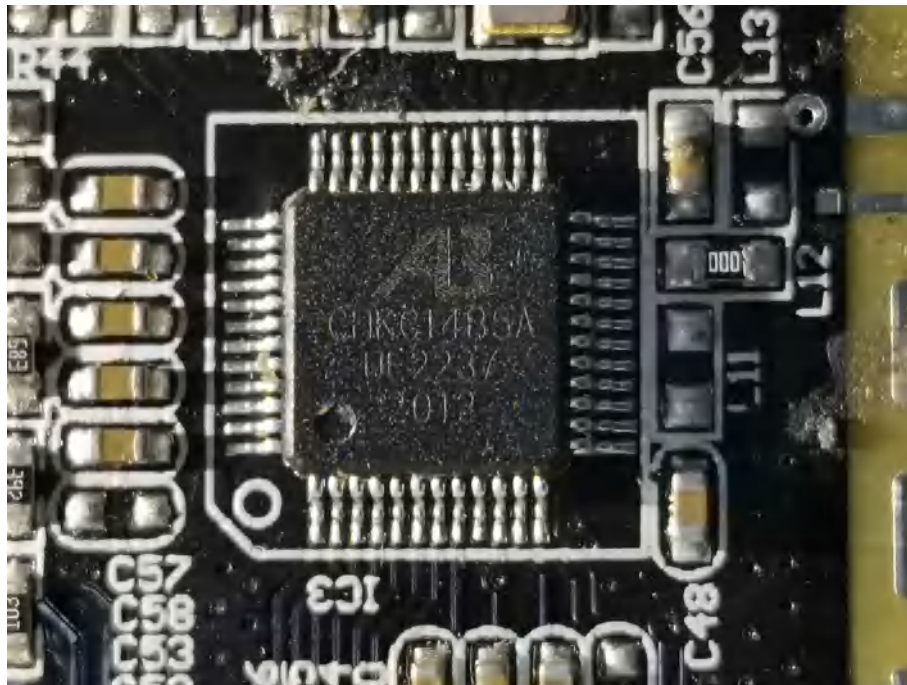
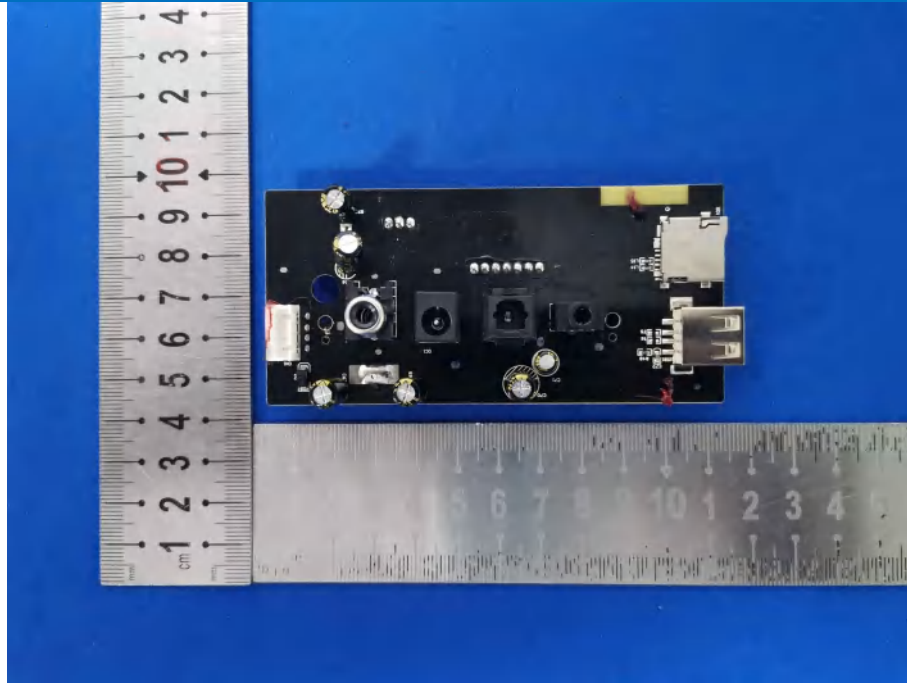

\*\*\* END OF REPORT \*\*\*