



FCC TEST REPORT

**Test report
On Behalf of
Number One Commerce Co., LTD
For
WIRELESS SPORTS HEADPHONES
Model No.: U8R
FCC ID: 2AS8H-U8R**

Prepared for : Number One Commerce Co., LTD
Room 1635, 16/F., Metro Centre 2, 21 Lam Hing Street, Kowloon Bay,
Hong Kong 999077, China

Prepared By : Shenzhen HUAKE Testing Technology Co., Ltd.
1F, B2 Building, Junfeng Zhongcheng Zhizao Innovation Park, Fuhai Street,
Bao'an District, Shenzhen City, China

Date of Test: Sept. 26, 2019 ~ Oct. 09, 2019

Date of Report: Oct. 09, 2019

Report Number: HK1909102490-2E



TEST RESULT CERTIFICATION

Applicant's name : Number One Commerce Co., LTD
 Address : Room 1635, 16/F., Metro Centre 2, 21 Lam Hing Street, Kowloon Bay, Hong Kong 999077, China
Manufacture's Name : Number One Commerce Co., LTD
 Address : Room 1635, 16/F., Metro Centre 2, 21 Lam Hing Street, Kowloon Bay, Hong Kong 999077, China

Product description

Trade Mark: RCA
 Product name : WIRELESS SPORTS HEADPHONES
 Model and/or type reference : U8R
 Standards : FCC Rules and Regulations Part 15 Subpart C Section 15.249
 ANSI C63.10: 2013

This publication may be reproduced in whole or in part for non-commercial purposes as long as the Shenzhen HUAKE Testing Technology Co., Ltd. is acknowledged as copyright owner and source of the material. Shenzhen HUAKE Testing Technology Co., Ltd. takes no responsibility for and will not assume liability for damages resulting from the reader's interpretation of the reproduced material due to its placement and context.

Date of Test..... :
 Date (s) of performance of tests : **Sept. 26, 2019 ~ Oct. 09, 2019**
 Date of Issue..... : **Oct. 09, 2019**
 Test Result : **Pass**

Testing Engineer : Gary Qian
 (Gary Qian)

Technical Manager : Eden Hu
 (Eden Hu)

Authorized Signatory : Jason Zhou
 (Jason Zhou)



Table of Contents	Page
1 . TEST SUMMARY	4
2 . GENERAL INFORMATION	5
2.1 GENERAL DESCRIPTION OF EUT	5
2.2 Carrier Frequency of Channels	6
2.3 Operation of EUT during testing	6
2.4 DESCRIPTION OF TEST SETUP	6
2.5 MEASUREMENT INSTRUMENTS LIST	7
3 . CONDUCTED EMISSIONS TEST	8
3.1 Conducted Power Line Emission Limit	8
3.2 Test Setup	8
3.3 Test Procedure	8
3.4 Test Result	8
4 RADIATED EMISSION TEST	11
4.1 Radiation Limit	11
4.2 Test Setup	11
4.3 Test Procedure	12
4.4 Test Result	12
5 BAND EDGE	18
5.1 Limits	18
5.2 Test Procedure	18
5.3 Test Result	19
6 OCCUPIED BANDWIDTH MEASUREMENT	21
6.1 Test Setup	21
6.2 Test Procedure	21
6.3 Measurement Equipment Used	21
6.4 Test Result	21
7 ANTENNA REQUIREMENT	23
8 PHOTOGRAPH OF TEST	24
8.1 Radiated Emission	24
8.2 Conducted Emission	25
9 PHOTOS OF THE EUT	26



1. TEST SUMMARY

1.1 TEST PROCEDURES AND RESULTS

DESCRIPTION OF TEST	RESULT
CONDUCTED EMISSIONS TEST	COMPLIANT
RADIATED EMISSION TEST	COMPLIANT
BAND EDGE	COMPLIANT
OCCUPIED BANDWIDTH MEASUREMENT	COMPLIANT
ANTENNA REQUIREMENT	COMPLIANT

1.2 TEST FACILITY

Test Firm : Shenzhen HUAKE Testing Technology Co., Ltd.

Address : 1F, B2 Building, Junfeng Zhongcheng Zhizao Innovation Park, Fuhai Street, Bao'an District, Shenzhen City, China

1.3 MEASUREMENT UNCERTAINTY

Measurement Uncertainty	
Conducted Emission Expanded Uncertainty	= 2.23dB, k=2
Radiated emission expanded uncertainty(9kHz-30MHz)	= 3.08dB, k=2
Radiated emission expanded uncertainty(30MHz-1000MHz)	= 4.42dB, k=2
Radiated emission expanded uncertainty(Above 1GHz)	= 4.06dB, k=2



2. GENERAL INFORMATION

2.1 GENERAL DESCRIPTION OF EUT

Equipment	WIRELESS SPORTS HEADPHONES
Model Name	U8R
Serial Model	/
Model Difference	/
FCC ID	2AS8H-U8R
Antenna Type	Internal Antenna
Antenna Gain	0dBi
BT Operation frequency	2402-2480MHz
Number of Channels	40CH
Modulation Type	GFSK
Power Source	DC 3.7V From Battery or DC 5V From USB
Power Rating	DC 3.7V From Battery or DC 5V From USB



2.2 Carrier Frequency of Channels

Channel List							
Channel	Frequency (MHz)	Channel	Frequency (MHz)	Channel	Frequency (MHz)	Channel	Frequency (MHz)
01	2402	11	2422	21	2442	31	2462
02	2404	12	2424	22	2444	32	2464
03	2406	13	2426	23	2446	33	2466
04	2408	14	2428	24	2448	34	2468
05	2410	15	2430	25	2450	35	2470
06	2412	16	2432	26	2452	36	2472
07	2414	17	2434	27	2454	37	2474
08	2416	18	2436	28	2456	38	2476
09	2418	19	2438	29	2458	39	2478
10	2420	20	2440	30	2460	40	2480

2.3 Operation of EUT during testing

Operating Mode

The mode is used: **Transmitting mode**

Low Channel: 2402MHz

Middle Channel: 2440MHz

High Channel: 2480MHz

2.4 DESCRIPTION OF TEST SETUP

Operation of EUT during conducted testing and Radiation testing:

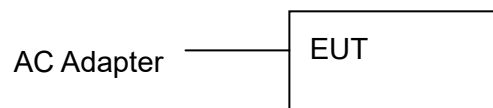

Operation of EUT during Above1GHz Radiation testing:

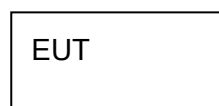

- Adapter information
Model: HW-95200CHQ
Input: 100-240V, 50/60Hz, 0.5A
Output: 5VDC, 2A



2.5 MEASUREMENT INSTRUMENTS LIST

Item	Equipment	Manufacturer	Model No.	Serial No.	Last Cal.	Cal. Interval
1.	L.I.S.N. Artificial Mains Network	R&S	ENV216	HKE-002	Dec. 27, 2018	1 Year
2.	Receiver	R&S	ESCI 7	HKE-010	Dec. 27, 2018	1 Year
3.	RF automatic control unit	Tonscend	JS0806-2	HKE-060	Dec. 27, 2018	1 Year
4.	Spectrum analyzer	R&S	FSP40	HKE-025	Dec. 27, 2018	1 Year
5.	Spectrum analyzer	Agilent	N9020A	HKE-048	Dec. 27, 2018	1 Year
6.	Preamplifier	Schwarzbeck	BBV 9743	HKE-006	Dec. 27, 2018	1 Year
7.	EMI Test Receiver	Rohde & Schwarz	ESCI 7	HKE-010	Dec. 27, 2018	1 Year
8.	Bilog Broadband Antenna	Schwarzbeck	VULB9163	HKE-012	Dec. 27, 2018	1 Year
9.	Loop Antenna	Schwarzbeck	FMZB 1519 B	HKE-014	Dec. 27, 2018	1 Year
10.	Horn Antenna	Schwarzbeck	9120D	HKE-013	Dec. 27, 2018	1 Year
11.	Pre-amplifier	EMCI	EMC051845 SE	HKE-015	Dec. 27, 2018	1 Year
12.	Pre-amplifier	Agilent	83051A	HKE-016	Dec. 27, 2018	1 Year
13.	EMI Test Software EZ-EMC	Tonscend	JY3120-B Version	HKE-083	Dec. 27, 2018	N/A
14.	Power Sensor	Agilent	E9300A	HKE-086	Dec. 27, 2018	1 Year
15.	Spectrum analyzer	Agilent	N9020A	HKE-048	Dec. 27, 2018	1 Year
16.	Signal generator	Agilent	N5182A	HKE-029	Dec. 27, 2018	1 Year
17.	Signal Generator	Agilent	83630A	HKE-028	Dec. 27, 2018	1 Year
18.	Shielded room	Shiel Hong	4*3*3	HKE-039	Dec. 27, 2018	3 Year



3. CONDUCTED EMISSIONS TEST

3.1 Conducted Power Line Emission Limit

For unintentional device, according to § 15.107(a) Line Conducted Emission Limits is as following

Frequency (MHz)	Maximum RF Line Voltage (dB μ V)			
	CLASS A		CLASS B	
	Q.P.	Ave.	Q.P.	Ave.
0.15 - 0.50	79	66	66-56*	56-46*
0.50 - 5.00	73	60	56	46
5.00 - 30.0	73	60	60	50

* Decreasing linearly with the logarithm of the frequency

For intentional device, according to §15.207(a) Line Conducted Emission Limit is same as above table.

3.2 Test Setup

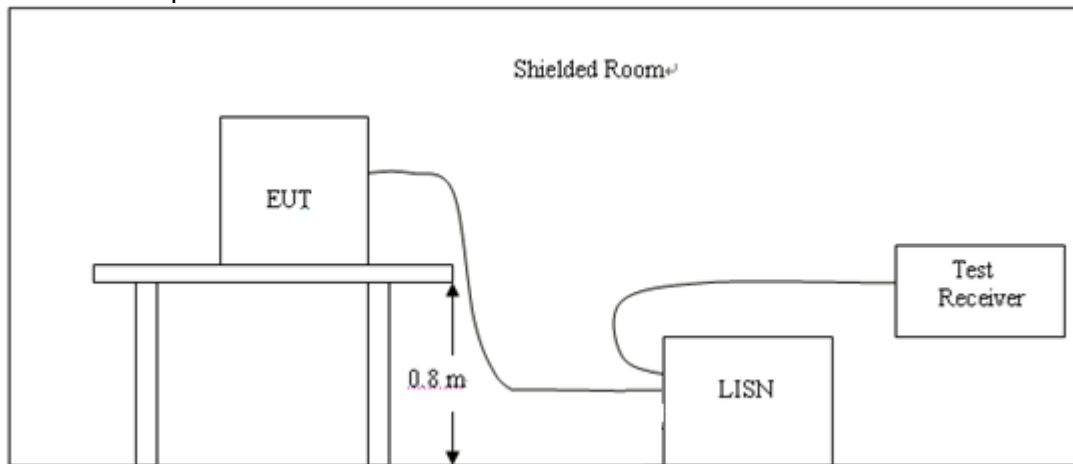

3.3 Test Procedure

- 1, The equipment was set up as per the test configuration to simulate typical actual usage per the user's manual. The EUT is a tabletop system, a wooden table with a height of 0.8 meters is used and is placed on the ground plane as per ANSI C63.10.
- 2, Support equipment, if needed, was placed as per ANSI C63.10.
- 3, All I/O cables were positioned to simulate typical actual usage as per ANSI C63.10.
- 4, If a EUT received DC power from the USB Port of Notebook PC, the PC's adapter received AC120V/60Hz power through a Line Impedance Stabilization Network (LISN) which supplied power source and was grounded to the ground plane.
- 5, All support equipments received AC power from a second LISN, if any.
- 6, The EUT test program was started. Emissions were measured on each current carrying line of the EUT using a spectrum Analyzer / Receiver connected to the LISN powering the EUT. The LISN has two monitoring points: Line 1 (Hot Side) and Line 2 (Neutral Side). Two scans were taken: one with Line 1 connected to Analyzer / Receiver and Line 2 connected to a 50 ohm load; the second scan had Line 1 connected to a 50 ohm load and Line 2 connected to the Analyzer / Receiver.
- 7, Analyzer / Receiver scanned from 150 KHz to 30MHz for emissions in each of the test modes.

3.4 Test Result

PASS

All the test modes completed for test. only the worst result of of AC240V/60Hz (GFSK High Channel) was reported as below:



Test Specification: Line

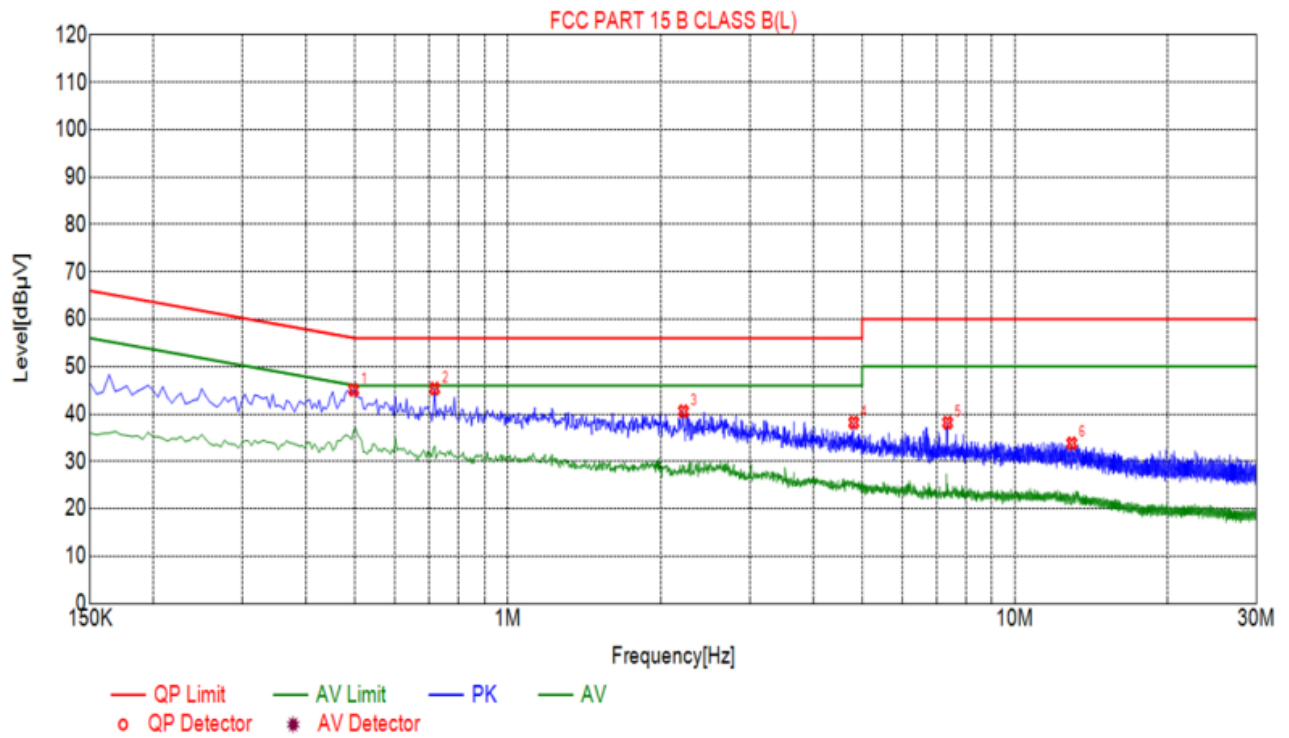

Suspected List						
NO.	Freq. [MHz]	Level [dBµV]	Factor [dB]	Limit [dBµV]	Margin [dB]	Detector
1	0.4965	45.08	10.04	56.06	10.98	PK
2	0.7170	45.36	10.05	56.00	10.64	PK
3	2.2200	40.59	10.17	56.00	15.41	PK
4	4.8120	38.20	10.26	56.00	17.80	PK
5	7.3680	38.18	10.18	60.00	21.82	PK
6	12.9570	33.81	9.97	60.00	26.19	PK

Remark: Margin = Limit – Level



Test Specification: Neutral

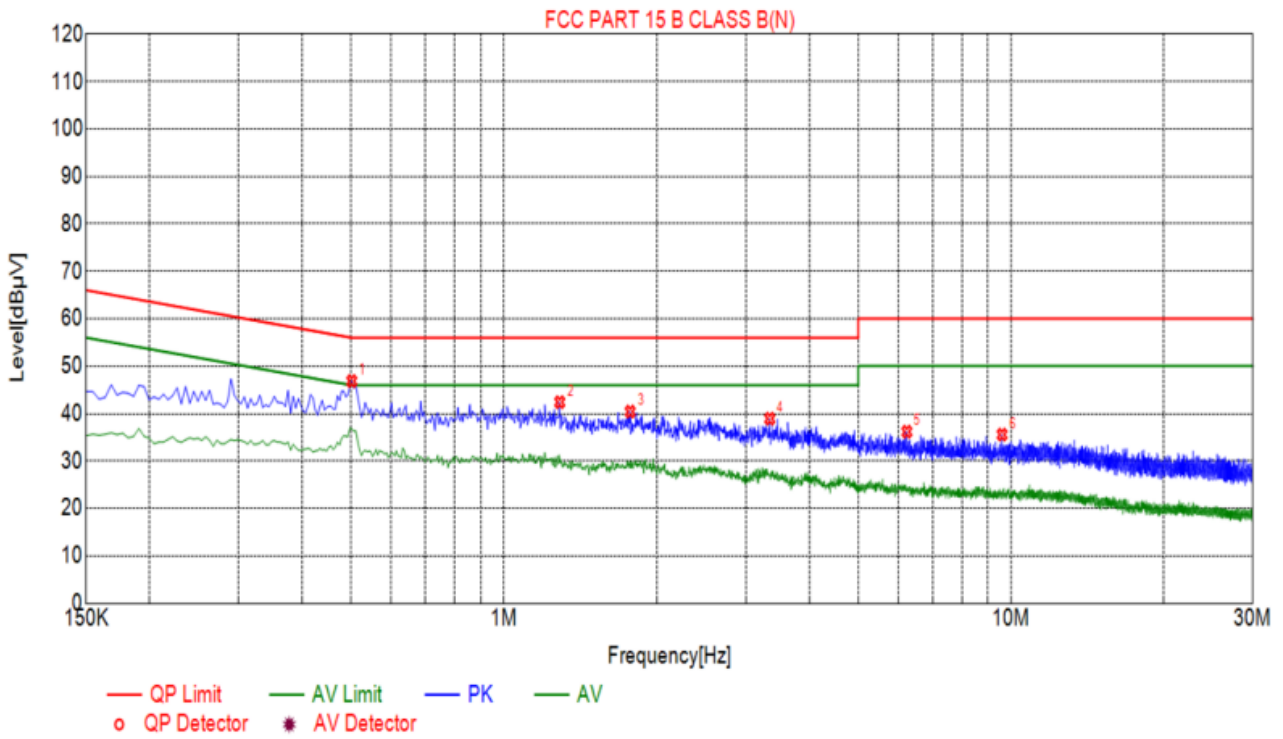

Suspected List						
NO.	Freq. [MHz]	Level [dBμV]	Factor [dB]	Limit [dBμV]	Margin [dB]	Detector
1	0.5010	46.86	10.04	56.00	9.14	PK
2	1.2885	42.41	10.09	56.00	13.59	PK
3	1.7745	40.42	10.14	56.00	15.58	PK
4	3.3450	38.93	10.24	56.00	17.07	PK
5	6.2340	36.18	10.22	60.00	23.82	PK
6	9.6090	35.58	10.08	60.00	24.42	PK

Remark: Margin = Limit – Level

4 RADIATED EMISSION TEST

4.1 Radiation Limit

For unintentional device, according to § 15.109(a), except for Class A digital devices, the field strength of radiated emissions from unintentional radiators at a distance of 3 meters shall not exceed the following values:

Frequency (MHz)	Distance (Meters)	Radiated (dB μ V/m)	Radiated (μ V/m)
30-88	3	40	100
88-216	3	43.5	150
216-960	3	46	200
Above 960	3	54	500

For intentional device, according to § 15.209(a), the general requirement of field strength of radiated emissions from intentional radiators at a distance of 3 meters shall not exceed the above table.

4.2 Test Setup

(1) Radiated Emission Test-Up Frequency Below 30MHz

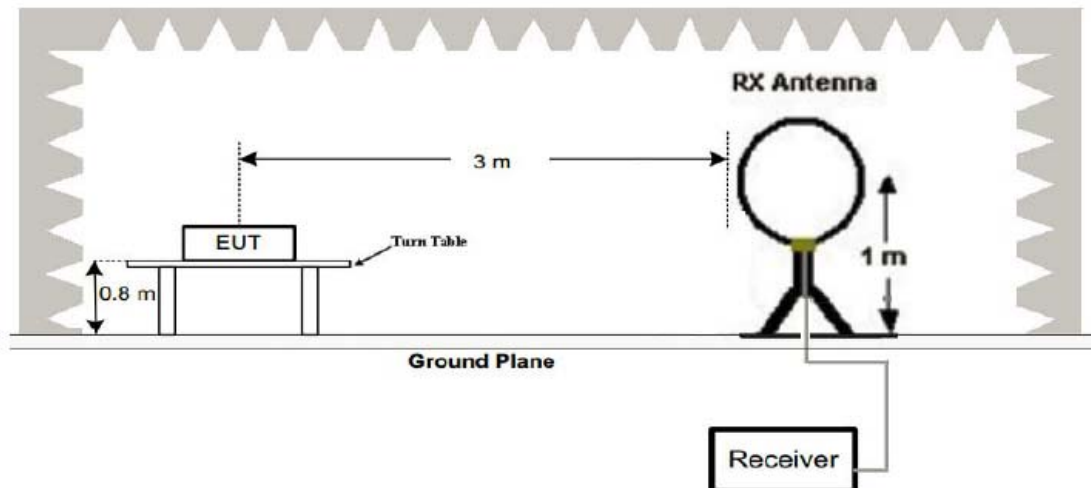

(2) Radiated Emission Test-Up Frequency 30MHz~1GHz

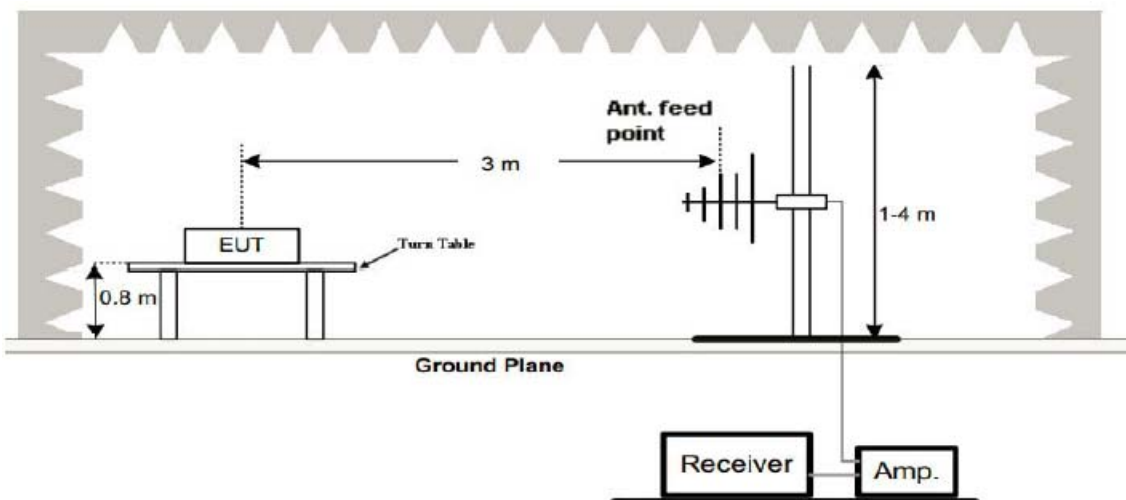

(3) Radiated Emission Test-Up Frequency Above 1GHz

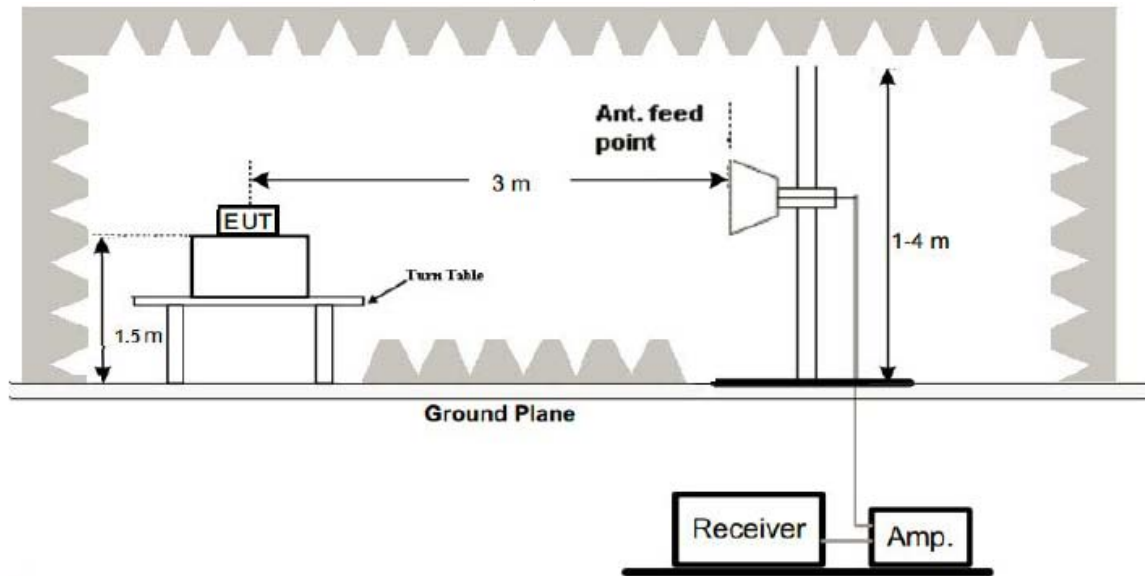

4.3 Test Procedure

1. Below 1GHz measurement the EUT is placed on turntable which is 0.8m above ground plane. And above 1GHz measurement EUT was placed on low permittivity and low tangent turn table which is 1.5m above ground plane.
2. The turntable shall be rotated for 360 degrees to determine the position of maximum emission level.
3. EUT is set 3m away from the receiving antenna, which is varied from 1m to 4m to find out the highest emissions.
4. Maximum procedure was performed on the six highest emissions to ensure EUT compliance.
5. And also, each emission was to be maximized by changing the polarization of receiving antenna both horizontal and vertical.
6. Repeat above procedures until the measurements for all frequencies are complete.
7. The test frequency range from 9KHz to 25GHz per FCC PART 15.33(a).

Note:

For battery operated equipment, the equipment tests shall be performed using a new battery.

4.4 Test Result

PASS

All the test modes completed for test. The worst case of Radiated Emission is CH 2402; the test data of this mode was reported.



Below 1GHz Test Results:

Antenna polarity: H

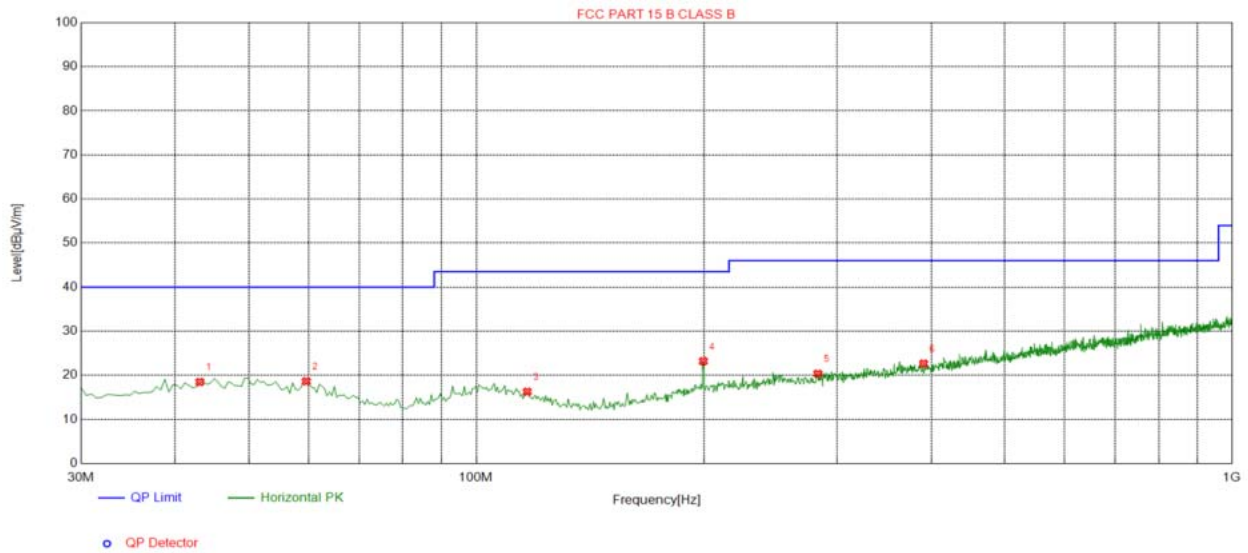

Suspected List								
NO.	Freq. [MHz]	Level [dBµV/m]	Factor [dB]	Limit [dBµV/m]	Margin [dB]	Height [cm]	Angle [°]	Polarity
1	43.0950	18.46	-13.99	40.00	21.54	100	348	Horizontal
2	59.5850	18.62	-15.10	40.00	21.38	100	32	Horizontal
3	116.815	16.24	-16.57	43.50	27.26	100	46	Horizontal
4	199.750	23.19	-15.08	43.50	20.31	100	49	Horizontal
5	283.170	20.34	-13.12	46.00	25.66	100	300	Horizontal
6	390.840	22.66	-10.63	46.00	23.34	100	66	Horizontal

Remark: Transd = Cable lose + Antenna factor - Pre-amplifier; Margin = Limit – Level



Antenna polarity: V

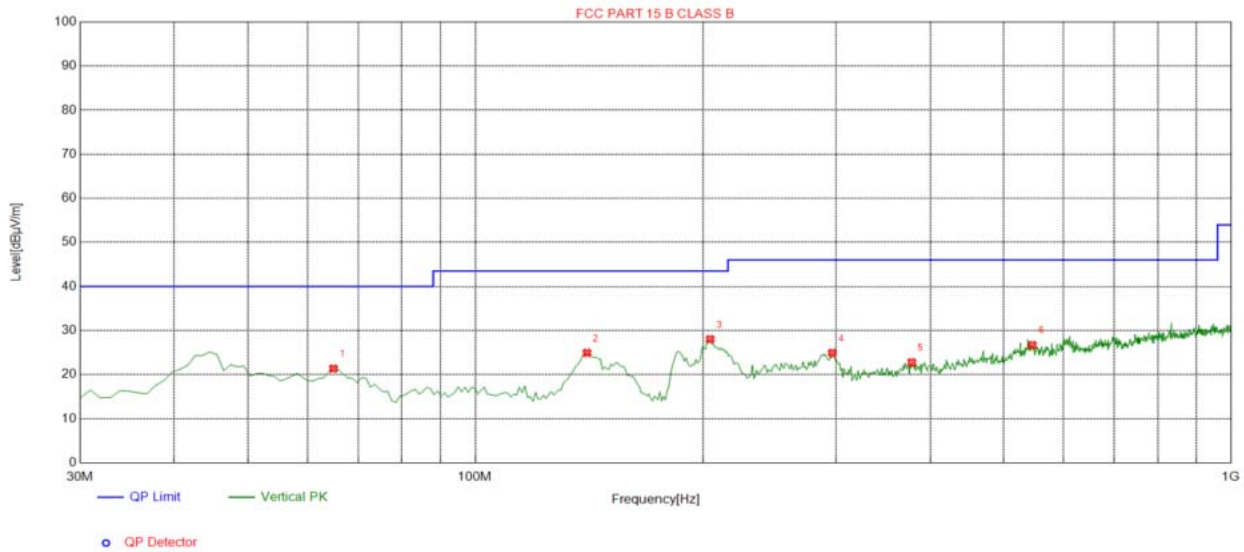

Suspected List								
NO.	Freq. [MHz]	Level [dBµV/m]	Factor [dB]	Limit [dBµV/m]	Margin [dB]	Height [cm]	Angle [°]	Polarity
1	64.9200	21.35	-16.39	40.00	18.65	100	122	Vertical
2	140.580	24.93	-19.17	43.50	18.57	100	221	Vertical
3	204.600	28.02	-14.94	43.50	15.48	100	215	Vertical
4	296.750	24.92	-12.77	46.00	21.08	100	37	Vertical
5	378.230	22.77	-10.86	46.00	23.23	100	154	Vertical
6	546.040	26.69	-7.06	46.00	19.31	100	78	Vertical

Remark: Transd = Cable lose + Antenna factor - Pre-amplifier; Margin = Limit – Level

Remark:

- (1) Measuring frequencies from 9 KHz to the 1 GHz, Radiated emission test from 9KHz to 30MHz was verified, and no any emission was found except system noise floor.
- (2) * denotes emission frequency which appearing within the Restricted Bands specified in provision of 15.205, then the general radiated emission limits in 15.209 apply.
- (3) The IF bandwidth of EMI Test Receiver between 30MHz to 1GHz was 120KHz, 1 MHz for measuring above 1 GHz, below 30MHz was 10KHz.



Above 1 GHz Test Results:
CH Low (2402MHz)

Horizontal:

Frequency	Meter Reading	Factor	Emission Level	Limits	Margin	Detector Type
(MHz)	(dB μ V)	(dB)	(dB μ V/m)	(dB μ V/m)	(dB)	
2402	108.99	-5.84	103.15	114	-10.85	peak
2402	86.34	-5.84	80.5	94	-13.5	AVG
4804	57.68	-3.64	54.04	74	-19.96	peak
4804	43.15	-3.64	39.51	54	-14.49	AVG
7206	55.27	-0.95	54.32	74	-19.68	peak
7206	41.54	-0.95	40.59	54	-13.41	AVG

Remark: Factor = Antenna Factor + Cable Loss – Pre-amplifier.

Vertical:

Frequency	Meter Reading	Factor	Emission Level	Limits	Margin	Detector Type
(MHz)	(dB μ V)	(dB)	(dB μ V/m)	(dB μ V/m)	(dB)	
2402	111.12	-5.84	105.28	114	-8.72	peak
2402	83.34	-5.84	77.5	94	-16.5	AVG
4804	54.47	-3.64	50.83	74	-23.17	peak
4804	45.86	-3.64	42.22	54	-11.78	AVG
7206	52.26	-0.95	51.31	74	-22.69	peak
7206	38.49	-0.95	37.54	54	-16.46	AVG

Remark: Factor = Antenna Factor + Cable Loss – Pre-amplifier.



CH Middle (2440MHz)

Horizontal:

Frequency	Meter Reading	Factor	Emission Level	Limits	Margin	Detector Type
(MHz)	(dB μ V)	(dB)	(dB μ V/m)	(dB μ V/m)	(dB)	
2440	108.35	-5.71	102.64	114	-11.36	peak
2440	80.74	-5.71	75.03	94	-18.97	AVG
4880	51.33	-3.51	47.82	74	-26.18	peak
4880	42.67	-3.51	39.16	54	-14.84	AVG
7320	52.81	-0.82	51.99	74	-22.01	peak
7320	38.64	-0.82	37.82	54	-16.18	AVG

Remark: Factor = Antenna Factor + Cable Loss – Pre-amplifier.

Vertical:

Frequency	Meter Reading	Factor	Emission Level	Limits	Margin	Detector Type
(MHz)	(dB μ V)	(dB)	(dB μ V/m)	(dB μ V/m)	(dB)	
2440	104.55	-5.71	98.84	114	-15.16	peak
2440	84.37	-5.71	78.66	94	-15.34	AVG
4880	55.49	-3.51	51.98	74	-22.02	peak
4880	43.76	-3.51	40.25	54	-13.75	AVG
7320	52.16	-0.82	51.34	74	-22.66	peak
7320	40.88	-0.82	40.06	54	-13.94	AVG

Remark: Factor = Antenna Factor + Cable Loss – Pre-amplifier.



CH High (2480MHz)

Horizontal:

Frequency	Meter Reading	Factor	Emission Level	Limits	Margin	Detector Type
(MHz)	(dB μ V)	(dB)	(dB μ V/m)	(dB μ V/m)	(dB)	
2480	105.34	-5.65	99.69	114	-14.31	peak
2480	82.64	-5.65	76.99	94	-17.01	AVG
4960	52.11	-3.43	48.68	74	-25.32	peak
4960	41.74	-3.43	38.31	54	-15.69	AVG
7440	53.98	-0.75	53.23	74	-20.77	peak
7440	36.77	-0.75	36.02	54	-17.98	AVG

Remark: Factor = Antenna Factor + Cable Loss – Pre-amplifier.

Vertical:

Frequency	Meter Reading	Factor	Emission Level	Limits	Margin	Detector Type
(MHz)	(dB μ V)	(dB)	(dB μ V/m)	(dB μ V/m)	(dB)	
2480	105.38	-5.65	99.73	114	-14.27	peak
2480	82.34	-5.65	76.69	94	-17.31	AVG
4960	52.64	-3.43	49.21	74	-24.79	peak
4960	44.15	-3.43	40.72	54	-13.28	AVG
7440	55.77	-0.75	55.02	74	-18.98	peak
7440	37.62	-0.75	36.87	54	-17.13	AVG

Remark: Factor = Antenna Factor + Cable Loss – Pre-amplifier.

Remark :

- (1) Measuring frequencies from 1 GHz to the 25 GHz.
- (2) "F" denotes fundamental frequency; "H" denotes spurious frequency. "E" denotes band edge frequency.
- (3) * denotes emission frequency which appearing within the Restricted Bands specified in provision of 15.205, then the general radiated emission limits in 15.209 apply.
- (4) Data of measurement within this frequency range shown "---" in the table above means the reading of emissions are attenuated more than 20dB below the permissible limits or the field strength is too small to be measured.
- (5) The IF bandwidth of EMI Test Receiver between 30MHz to 1GHz was 120KHz, 1 MHz for measuring above 1 GHz, below 30MHz was 10KHz. The resolution bandwidth of test receiver/spectrum analyzer is 1MHz and video bandwidth is 3MHz for peak measurement with peak detector at frequency above 1GHz. The resolution bandwidth of test receiver/spectrum analyzer is 1MHz and video bandwidth is 10Hz for Average measurement with peak detection at frequency above 1GHz.
- (6) When the test results of Peak Detected below the limits of Average Detected, the Average Detected is not need completed. For example: Top Channel at Fundamental 73.16dBuV/m(PK Value) <93.98(AV Limit), at harmonic 53.20 dBuV/m(PK Value) <54 dBuV/m(AV Limit), the Average Detected not need to completed.
- (7) All modes of operation were investigated and the worst-case emissions are reported.



5 BAND EDGE

5.1 Limits

FCC PART 15.249(d) Emissions radiated outside of the specified frequency bands, except for harmonics, shall be attenuated by at least 50 dB below the level of the fundamental or to the general radiated emission limits in §15.209, whichever is the lesser attenuation.

5.2 Test Procedure

The band edge compliance of RF radiated emission should be measured by following the guidance in ANSI C63.10 with respect to maximizing the emission by rotating the EUT, measuring the emission while the EUT is situated in three orthogonal planes (if appropriate), adjusting the measurement antenna height and polarization etc. Set RBW to 100KHz and VBM to 300KHz to measure the peak field strength and set RBW to 1MHz and VBW to 10Hz to measure the average radiated field strength. The conducted RF band edge was measured by using a spectrum analyzer. Set span wide enough to capture the highest in-band emission and the emission at the band edge. Set RBW to 100 KHz and VBW to 300 KHz, to measure the conducted peak band edge.



5.3 Test Result

PASS

Radiated Band Edge Test:

Operation Mode: TX CH Low (2402MHz)

Horizontal (Worst case)

Frequency (MHz)	Meter Reading (dB μ V)	Factor (dB)	Emission Level (dB μ V/m)	Limits (dB μ V/m)	Margin (dB)	Detector Type
2310	57.34	-5.81	51.53	74	-22.47	peak
2310	/	-5.81	/	54	/	AVG
2390	53.16	-5.84	47.32	74	-26.68	peak
2390	/	-5.84	/	54	/	AVG
2400	51.28	-5.84	45.44	74	-28.56	peak
2400	/	-5.84	/	54	/	AVG

Remark: Factor = Antenna Factor + Cable Loss – Pre-amplifier.

Vertical:

Frequency (MHz)	Meter Reading (dB μ V)	Factor (dB)	Emission Level (dB μ V/m)	Limits (dB μ V/m)	Margin (dB)	Detector Type
2310	56.34	-5.81	50.53	74	-23.47	peak
2310	/	-5.81	/	54	/	AVG
2390	52.58	-5.84	46.74	74	-27.26	peak
2390	/	-5.84	/	54	/	AVG
2400	55.67	-5.84	49.83	74	-24.17	peak
2400	/	-5.84	/	54	/	AVG

Remark: Factor = Antenna Factor + Cable Loss – Pre-amplifier.



Operation Mode: TX CH High (2480MHz)

Horizontal (Worst case)

Frequency	Reading Result	Factor	Emission Level	Limits	Margin	Detector Type
(MHz)	(dBµV)	(dB)	(dBµV/m)	(dBµV/m)	(dB)	
2483.50	56.34	-5.65	50.69	74	-23.31	peak
2483.50	/	-5.65	/	54	/	AVG
2500.00	53.27	-5.65	47.62	74	-26.38	peak
2500.00	/	-5.65	/	54	/	AVG

Remark: Factor = Antenna Factor + Cable Loss – Pre-amplifier.

Vertical:

Frequency	Reading Result	Factor	Emission Level	Limits	Margin	Detector Type
(MHz)	(dBµV)	(dB)	(dBµV/m)	(dBµV/m)	(dB)	
2483.50	56.34	-5.65	50.69	74	-23.31	peak
2483.50	/	-5.65	/	54	/	AVG
2500.00	52.43	-5.65	46.78	74	-27.22	peak
2500.00	/	-5.65	/	54	/	AVG

Remark: Factor = Antenna Factor + Cable Loss – Pre-amplifier.

Remark: All the other emissions not reported were too low to read and deemed to comply with FCC limit.



6 OCCUPIED BANDWIDTH MEASUREMENT

6.1 Test Setup

Same as Radiated Emission Measurement

6.2 Test Procedure

1. The EUT was placed on a turn table which is 0.8m above ground plane.
2. Set EUT as normal operation.
3. Based on ANSI C63.10 section 6.9.2: RBW= 30KHz. VBW= 100 KHz, Span=4MHz.
4. The useful radiated emission from the EUT was detected by the spectrum analyser with peak detector.

6.3 Measurement Equipment Used

Same as Radiated Emission Measurement

6.4 Test Result

PASS

Frequency	20dB Bandwidth (MHz)	Result
2402 MHz	1.117	PASS
2440 MHz	1.123	PASS
2480 MHz	1.116	PASS

CH: 2402MHz

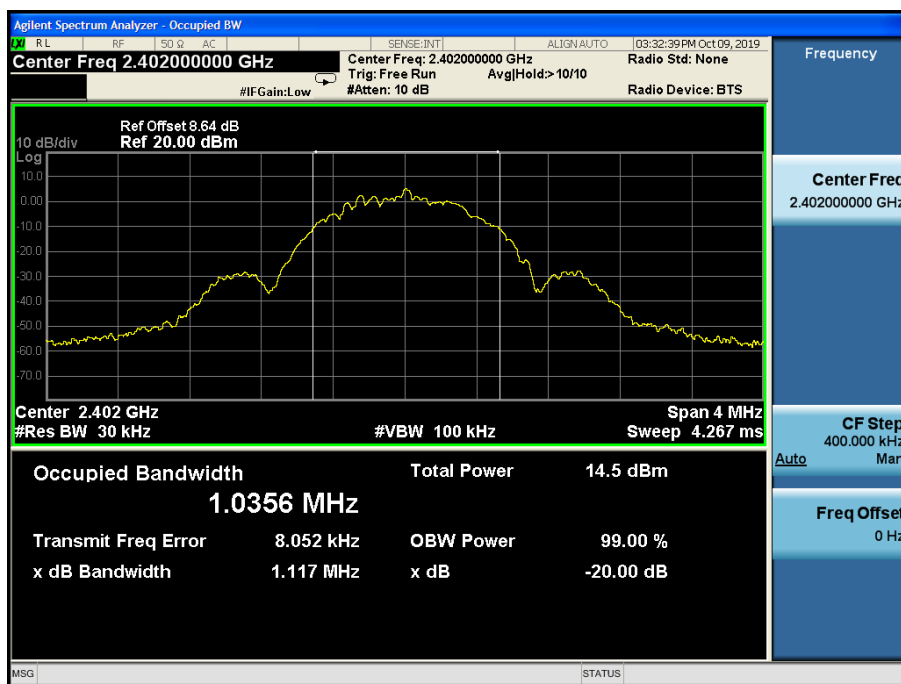



CH: 2440MHz



CH: 2480MHz

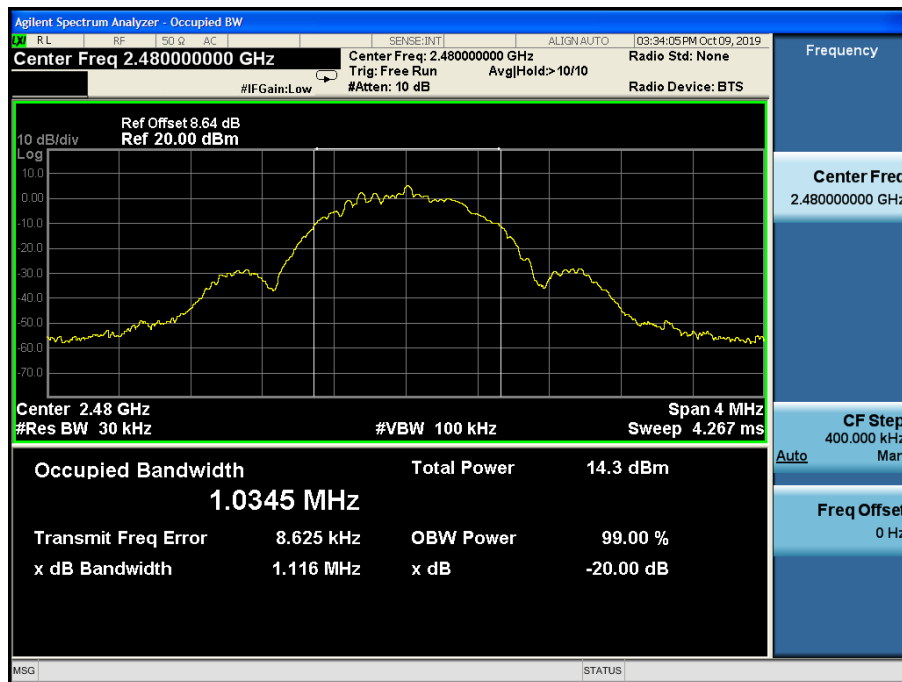

7 ANTENNA REQUIREMENT

Standard Applicable

For intentional device, according to FCC 47 CFR Section 15.203, an intentional radiator shall be designed to ensure that no antenna other than that furnished by the responsible party shall be used with the device.

Antenna Connected Construction

The antenna used in this product is a Internal Antenna, The directional gains of antenna used for transmitting is 0dBi.

BT ANTENNA

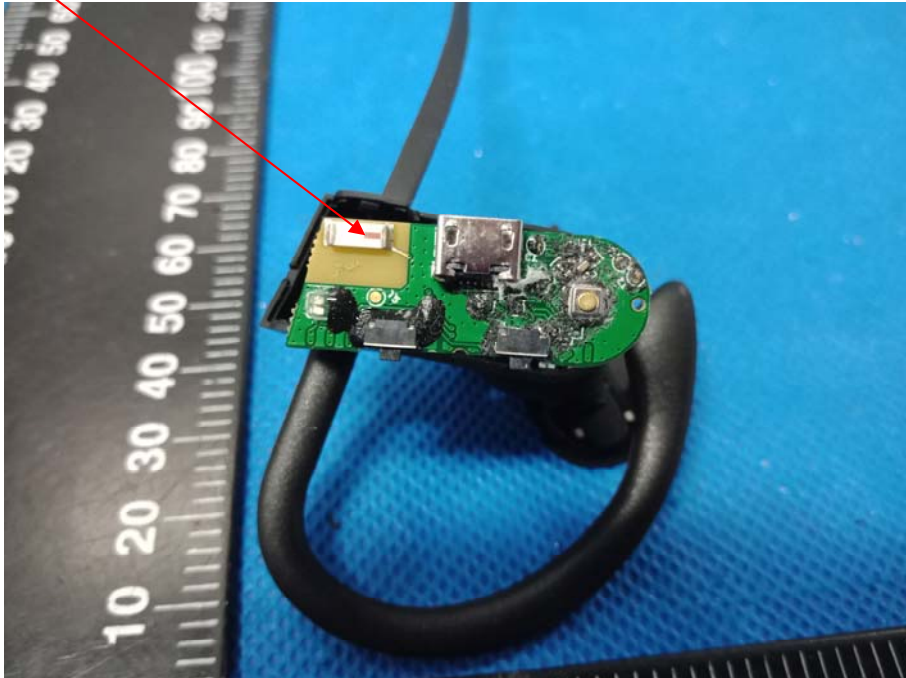

8 PHOTOGRAPH OF TEST

8.1 Radiated Emission

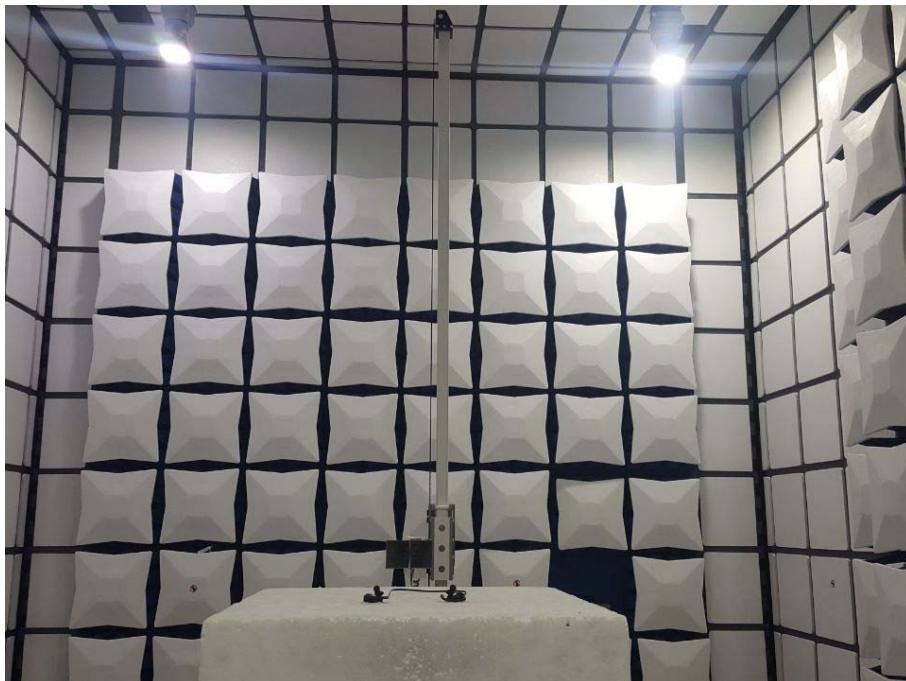



8.2 Conducted Emission





9 PHOTOS OF THE EUT

Reference to the reporter : ANNEX A of external photos and ANNEX B of internal photos

-----End of test report-----