



MEASUREMENT REPORT

FCC PART 15.247 & IC RSS-247 Bluetooth LE

FCC ID: 2AS8DS22
IC: 25026-S22
APPLICANT: Sequent AG

Application Type: Certification

Product: SEQUENT ELEKTRON WATCH,
SEQUENT SUPERCHARGER WATCH

Model No.: S2.2 TITANIUM

Serial Model: S2.2 STEEL-ALU

FCC Classification: (DTS) Digital Transmission System

FCC Rule Part(s): Part 15.247

ISED Standard: RSS-247 Issue 2

Test Procedure(s): ANSI C63.10-2013

Received Date: December 3 ,2021

Test Date: December 9~10 ,2021

Tested By : *Fran Chen*
(Fran Chen)

Reviewed By : *Paddy Chen*
(Paddy Chen)

Approved By : *Chenz Ker*
(Chenz Ker)



The test results only relate to the tested sample.

This equipment has been shown to be capable of compliance with the applicable technical standards as indicated in the measurement report and was tested in accordance with the measurement procedures specified in ANSI C63.10. Test results reported herein relate only to the item(s) tested.

The test report shall not be reproduced except in full without the written approval of MRT Technology (Taiwan) Co., Ltd.

Revision History

Report No.	Version	Description	Issue Date
2112TW8201-U2	1.0	Original Report	2021-12-24

CONTENTS

Description	Page
§2.1033 General Information	5
1. INTRODUCTION	6
1.1. Scope	6
1.2. MRT Test Location.....	6
2. PRODUCT INFORMATION	7
2.1. Equipment Description	7
2.2. Product Specification Subjective to this Standard.....	8
2.3. Test Mode	8
2.4. Operation Frequency / Channel List	9
2.5. Test Configuration.....	10
2.6. Test Software.....	10
2.7. EMI Suppression Device(s)/Modifications.....	10
2.8. Labeling Requirements	10
3. DESCRIPTION of TEST	11
3.1. Evaluation Procedure.....	11
3.2. AC Line Conducted Emissions.....	11
3.3. Radiated Emissions	12
4. ANTENNA REQUIREMENTS	13
5. TEST EQUIPMENT CALIBRATION DATE	14
6. MEASUREMENT UNCERTAINTY	15
7. TEST RESULT	16
7.1. Summary.....	16
7.2. Occupied Bandwidth Measurement	17
7.2.1. Test Limit.....	17
7.2.2. Test Procedure used	17
7.2.3. Test Setting	17
7.2.4. Test Setup	17
7.2.5. Test Result	18
7.3. Output Power Measurement	21
7.3.1. Test Limit.....	21
7.3.2. Test Procedure Used.....	21
7.3.3. Test Setting	21
7.3.4. Test Setup	21
7.3.5. Test Result of Output Power	22
7.4. Power Spectral Density Measurement.....	23
7.4.1. Test Limit.....	23
7.4.2. Test Procedure Used.....	23
7.4.3. Test Setting	23
7.4.4. Test Setup	23
7.4.5. Test Result	24

7.5.	Out-of-Band Spurious Emissions Emissions Measurement.....	26
7.5.1.	Test Limit	26
7.5.2.	Test Procedure Used.....	26
7.5.3.	Test Settiting	26
7.5.4.	Test Setup	26
7.5.5.	Test Result	27
7.6.	Radiated Spurious Emission Measurement.....	30
7.6.1.	Test Limit	30
7.6.2.	Test Procedure Used.....	30
7.6.3.	Test Setting	30
7.6.4.	Test Setup	32
7.6.5.	Test Result	34
7.7.	Radiated Restricted Band Edge Measurement.....	50
7.7.1.	Test Limit	50
7.7.2.	Test Procedure Used.....	50
7.7.3.	Test Setting	50
7.7.4.	Test Setup	52
7.7.5.	Test Result	53
7.8.	AC Conducted Emissions Measurement	58
7.8.1.	Test Limit	58
7.8.2.	Test Setup	58
7.8.3.	Test Result	59
8.	CONCLUSION	63

§2.1033 General Information

Applicant	Sequent AG
Applicant Address	Eptingerstrasse 3, 4052 Basel, Switzerland
Manufacturer	Sequent Lab Ltd.
Manufacturer Address	3F.-2, No. 99, Jingye 1st Rd., Zhongshan Dist., Taipei City 10462, Taiwan (R.O.C.)
Test Site	MRT Technology (Taiwan) Co., Ltd
Test Site Address	No. 38, Fuxing Second Rd., Guishan Dist., Taoyuan City 333, Taiwan (R.O.C)
MRT FCC Registration No.	291082
FCC Rule Part(s)	Part 15.247
IC Standard:	RSS-247 Issue 2
Test Device Serial No.	#1 <input type="checkbox"/> Production <input checked="" type="checkbox"/> Pre-Production <input type="checkbox"/> Engineering

Test Facility / Accreditations

1. MRT facility is a FCC registered (Reg. No. 291082) test facility with the site description report on file and is designated by the FCC as an Accredited Test Firm.
2. MRT facility is an IC registered (MRT Reg. No. 21723) test laboratory with the site description on file at Industry Canada.
3. MRT Lab is accredited to ISO 17025 by the Taiwan Accreditation Foundation (TAF Cert. No. 3261) in EMC, Telecommunications and Radio testing for FCC (Designation Number: TW3261), Industry Taiwan, EU and TELEC Rules.

1. INTRODUCTION

1.1. Scope

Measurement and determination of electromagnetic emissions (EMC) of radio frequency devices including intentional and/or unintentional radiators for compliance with the technical rules and regulations of the Federal Communications Commission and the Industry Canada Certification and Engineering Bureau.

1.2. MRT Test Location

The map below shows the location of the MRT LABORATORY, its proximity to the Taoyuan City. These measurement tests were conducted at the MRT Technology (Taiwan) Co., Ltd. Facility located at No.38, Fuxing 2nd Rd., Guishan Dist., Taoyuan City 33377, Taiwan (R.O.C).

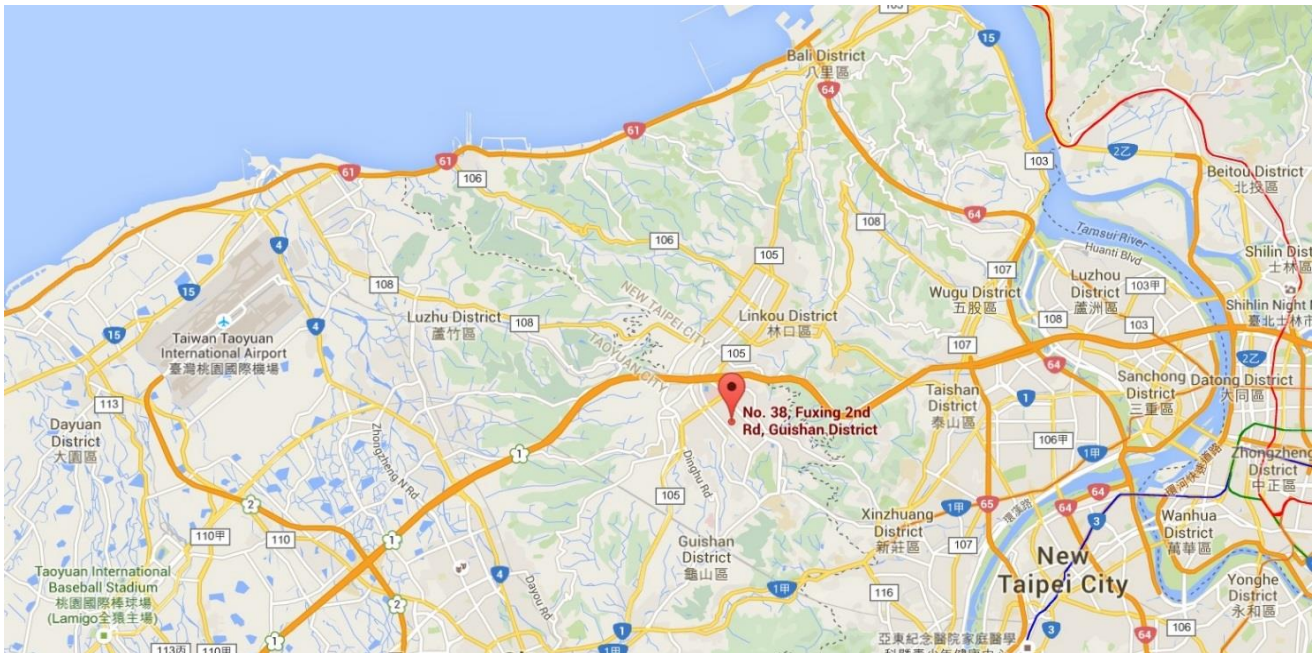

2. PRODUCT INFORMATION

2.1. Equipment Description

Product Name	SEQUENT ELEKTRON WATCH, SEQUENT SUPERCHARGER WATCH
Model No.	S2.2 TITANIUM
Serial Model:	S2.2 STEEL-ALU
Brand Name	Sequent
Bluetooth Specification	Bluetooth V5.0 LE
Maximum Power	-13.809dBm
Accessories	
USB Type C Cable	Brand: Sequent Model No: YDS-C-AC-1 Length : 1.2m (Shielded)
Sequent	Brand: Sequent M/N: SC22 Dock

Model Difference Description:

Product Name	Model No.	Model Difference
SEQUENT ELEKTRON WATCH	S2.2 TITANIUM	Has a TITANIUM Case and Bezel. (The ring around the glass.)
SEQUENT SUPERCHARGER WATCH	S2.2 STEEL-ALU	Has a STEEL-ALU Case and Bezel. (The ring around the glass.)

Note: The main test model is S2.2 TITANIUM.

2.2. Product Specification Subjective to this Standard

Operating Frequency	2402~2480MHz
Type of modulation	GFSK
Data Rate	1Mbps

2.3. Test Mode

Test Mode	Mode 1: Transmit – LE_1Mbps (GFSK)
-----------	------------------------------------

Note: Regarding to the operation frequency, the lowest, middle and highest frequency are selected to perform the test.

2.4. Operation Frequency / Channel List

Channel	Frequency	Channel	Frequency	Channel	Frequency
00	2402 MHz	01	2404 MHz	02	2406 MHz
03	2408 MHz	04	2410 MHz	05	2412 MHz
06	2414 MHz	07	2416 MHz	08	2418 MHz
09	2420 MHz	10	2422 MHz	11	2424 MHz
12	2426 MHz	13	2428 MHz	14	2430 MHz
15	2432 MHz	16	2434 MHz	17	2436 MHz
18	2438 MHz	19	2440 MHz	20	2442 MHz
21	2444 MHz	22	2446 MHz	23	2448 MHz
24	2450 MHz	25	2452 MHz	26	2454 MHz
27	2456 MHz	28	2458 MHz	29	2460 MHz
30	2462 MHz	31	2464 MHz	32	2466 MHz
33	2468 MHz	34	2470 MHz	35	2472 MHz
36	2474 MHz	37	2476 MHz	38	2478 MHz
39	2480 MHz	N/A	N/A	N/A	N/A

2.5. Test Configuration

This device was tested per the guidance of ANSI C63.10. ANSI C63.10 was used to reference the appropriate EUT setup for radiated spurious emissions testing and AC line conducted testing.

2.6. Test Software

The test utility software used during testing was “proctest.exe”.

2.7. EMI Suppression Device(s)/Modifications

No EMI suppression device(s) were added and/or no modifications were made during testing.

2.8. Labeling Requirements

Per 2.1074 & 15.19; Docket 95-19

The label shall be permanently affixed at a conspicuous location on the device; instruction manual or pamphlet supplied to the user and be readily visible to the purchaser at the time of purchase. However, when the device is so small wherein placement of the label with specified statement is not practical, only the FCC ID must be displayed on the device per Section 15.19(a)(5). Please see attachment for FCC ID label and label location.

3. DESCRIPTION of TEST

3.1. Evaluation Procedure

The measurement procedures described in the American National Standard for Testing Unlicensed Wireless Devices (ANSI C63.10-2013), and the guidance provided in KDB 558074 D01v05r02 were used in the measurement of the **SEQUENT ELEKTRON WATCH, SEQUENT SUPERCHARGER WATCH.**

Deviation from measurement procedure.....None

3.2. AC Line Conducted Emissions

The line-conducted facility is located inside an 9'x4'x3' shielded enclosure. A 1m x 2m wooden table 80cm high is placed 40cm away from the vertical wall and 80cm away from the sidewall of the shielded room. Two 10kHz-30MHz, 50Ω/50uH Line-Impedance Stabilization Networks (LISNs) are bonded to the shielded room floor. Power to the LISNs is filtered by external high-current high-insertion loss power line filters. These filters attenuate ambient signal noise from entering the measurement lines. These filters are also bonded to the shielded enclosure.

The EUT is powered from one LISN and the support equipment is powered from the second LISN. All interconnecting cables more than 1 meter were shortened to a 1 meter length by non-inductive bundling (serpentine fashion) and draped over the back edge of the test table. All cables were at least 40cm above the horizontal reference ground-plane. Power cables for support equipment were routed down to the second LISN while ensuring that that cables were not draped over the second LISN.

Sufficient time for the EUT, support equipment, and test equipment was allowed in order for them to warm up to their normal operating condition. The RF output of the LISN was connected to the receiver and exploratory measurements were made to determine the frequencies producing the maximum emission from the EUT. The receiver was scanned from 150kHz to 30MHz. The detector function was set to peak mode for exploratory measurements while the bandwidth of the analyzer was set to 9kHz. The EUT, support equipment, and interconnecting cables were arranged and manipulated to maximize each emission. Each emission was also maximized by varying: power lines, the mode of operation or data exchange speed, or support equipment which determined the worst-case emission. Once the worst case emissions have been identified, the one EUT cable configuration/arrangement and mode of operation that produced these emissions are used for final measurements on the same test site. The analyzer is set to CISPR quasi-peak and average detectors with a 9kHz resolution bandwidth for final measurements.

An extension cord was used to connect to a single LISN which powered by EUT. The extension cord was calibrated with LISN, the impedance and insertion loss are compliance with the requirements as stated in ANSI C63.10-2013.

Line conducted emissions test results are shown in Section 7.8.

3.3. Radiated Emissions

The radiated test facilities consisted of an indoor 3 meter semi-anechoic chamber used for final measurements and exploratory measurements, when necessary. The measurement area is contained within the semi-anechoic chamber which is shielded from any ambient interference. For measurements above 1GHz absorbers are arranged on the floor between the turn table and the antenna mast in such a way so as to maximize the reduction of reflections. For measurements below 1GHz, the absorbers are removed. A MF Model 210SS turntable is used for radiated measurement. It is a continuously rotatable, remote controlled, metallic turntable and 2 meters (6.56 ft.) in diameter. The turn table is flush with the raised floor of the chamber in order to maintain its function as a ground plane. An 80cm high PVC support structure is placed on top of the turntable.

For all measurements, the spectrum was scanned through all EUT azimuths and from 1 to 4 meter receive antenna height using a broadband antenna from 30MHz up to the upper frequency shown in 15.33(b)(1) depending on the highest frequency generated or used in the device or on which the device operates or tunes. For frequencies above 1GHz, linearly polarized double ridge horn antennas were used. For frequencies below 30MHz, a calibrated loop antenna was used. When exploratory measurements were necessary, they were performed at 1 meter test distance inside the semi-anechoic chamber using broadband antennas, broadband amplifiers, and spectrum analyzers to determine the frequencies and modes producing the maximum emissions. Sufficient time for the EUT, support equipment, and test equipment was allowed in order for them to warm up to their normal operating condition. The test set-up for frequencies below 1GHz was placed on top of the 0.8 meter high, 1 x 1.5 meter table; and test set-up for frequencies 1-40GHz was placed on top of the 1.5 meter high, 1 x 1.5 meter table. The EUT, support equipment, and interconnecting cables were arranged and manipulated to maximize each emission. Appropriate precaution was taken to ensure that all emissions from the EUT were maximized and investigated. The system configuration, clock speed, mode of operation or video resolution, if applicable, turntable azimuth, and receive antenna height was noted for each frequency found.

Final measurements were made in the semi-anechoic chamber using calibrated, linearly polarized broadband and horn antennas. The test setup was configured to the setup that produced the worst case emissions. The spectrum analyzer was set to investigate all frequencies required for testing to compare the highest radiated disturbances with respect to the specified limits. The turntable containing the EUT was rotated through 360 degrees and the height of the receive antenna was varied 1 to 4 meters and stopped at the azimuth and height producing the maximum emission. Each emission was maximized by changing the orientation of the EUT through three orthogonal planes and changing the polarity of the receive antenna, which produced the worst-case emissions. According to 3dB Beam-Width of horn antenna, the horn antenna should be always directed to the EUT when rising height.

Radiated emissions test results are shown in Section 7.6 & 7.7 .

4. ANTENNA REQUIREMENTS

Excerpt from §15.203 of the FCC Rules/Regulations:

“An intentional radiator antenna shall be designed to ensure that no antenna other than that furnished by the responsible party can be used with the device. The use of a permanently attached antenna or of an antenna that uses a unique coupling to the intentional radiator shall be considered sufficient to comply with the provisions of this section.”

- The antenna of the **SEQUENT ELEKTRON WATCH, SEQUENT SUPERCHARGER WATCH,** is permanently attached.
- There are no provisions for connection to an external antenna.

Conclusion:

The EUT unit complies with the requirement of §15.203.

Antenna List

No.	Manufacturer	Part No.	Antenna Type	Peak Gain
1	Rimon	WAN3216F245C0X	Chip	1.75dBi

5. TEST EQUIPMENT CALIBRATION DATE

Conducted Emissions – SR2

Instrument	Manufacturer	Type No.	Asset No.	Cali. Interval	Cali. Due Date
Two-Line V-Network	R&S	ENV216	MRTTWA00020	1 year	2022/4/28
Cable	Rosnol	N1C50-RG400-B 1C50-500CM	MRTTWE00013	1 year	2022/6/20
EMI Test Receiver	R&S	ESR3	MRTTWA00009	1 year	2022/3/24

Radiated Emissions – AC2

Instrument	Manufacturer	Type No.	Asset No.	Cali. Interval	Cali. Due Date
Broadband TRILOG Antenna	SCHWARZBECK	VULB 9162	MRTTWA00001	1 year	2022/10/4
EMI Test Receiver	R&S	ESR3	MRTTWA00009	1 year	2022/3/24
Active Loop Antenna	Schwarzbeck	FMZB 1519B	MRTTWA00002	1 year	2022/5/6
Broadband Hornantenna	RFSPIN	DRH18-E	MRTTWA00087	1 year	2022/8/31
Breitband Hornantenna	Schwarzbeck	BBHA 9170	MRTTWA00004	1 year	2022/4/28
Broadband Preampfier	EMC Instruments corporation	EMC118A45SE	MRTTWA00088	1 year	2022/8/31
Broadband Preampfier	SCHWARZBECK	BBV 9718	MRTTWA00005	1 year	2022/4/21
Cable	HUBERSUHNER	SF106	MRTTWE00034	1 year	2022/6/28

Conducted Test Equipment – SR5

Instrument	Manufacturer	Type No.	Asset No.	Cali. Interval	Cali. Due Date
EXA Signal Analyzer	KEYSIGHT	N9010A	MRTTWA00012	1 year	2022/10/18
EXA Signal Analyzer	KEYSIGHT	N9010B	MRTTWA00074	1 year	2022/7/19
USB Wideband Power Sensor	KEYSIGHT	U2021XA	MRTTWA00015	1 year	2022/3/24

Test Software

Software	Version	Function
e3	9.160520a	EMI Test Software
EMI	V3	EMI Test Software

6. MEASUREMENT UNCERTAINTY

Where relevant, the following test uncertainty levels have been estimated for tests performed on the EUT as specified in CISPR 16-4-2. This uncertainty represents an expanded uncertainty expressed at approximately the 95% confidence level using a coverage factor of $k = 2$.

Conducted Emission- Power Line
Measuring Uncertainty for a Level of Confidence of 95% ($U=2Uc(y)$): 0.15MHz~30MHz: $\pm 2.53\text{dB}$
Radiated Spurious Emission
Measuring Uncertainty for a Level of Confidence of 95% ($U=2Uc(y)$): 9kHz~30MHz: $\pm 3.92\text{dB}$ 30MHz~1GHz: $\pm 4.25\text{dB}$ 1GHz~18GHz: $\pm 4.40\text{dB}$ 18GHz~40GHz: $\pm 4.45\text{dB}$
Frequency Error
Measuring Uncertainty for a Level of Confidence of 95% ($U=2Uc(y)$): $\pm 78.4\text{Hz}$
Conducted Power
Measuring Uncertainty for a Level of Confidence of 95% ($U=2Uc(y)$): $\pm 0.84\text{dB}$
Conducted Spurious Emission
Measuring Uncertainty for a Level of Confidence of 95% ($U=2Uc(y)$): $\pm 2.65\text{ dB}$
Occupied Bandwidth
Measuring Uncertainty for a Level of Confidence of 95% ($U=2Uc(y)$): 3.3%
Temp. / Humidity
Measuring Uncertainty for a Level of Confidence of 95% ($U=2Uc(y)$): $\pm 0.82^\circ\text{C}/ \pm 3\%$
DC Voltage
Measuring Uncertainty for a Level of Confidence of 95% ($U=2Uc(y)$): $\pm 0.3\%$

7. TEST RESULT

7.1. Summary

Product Name: SEQUENT ELEKTRON WATCH,
 SEQUENT SUPERCHARGER WATCH
FCC Classification: (DTS) Digital Transmission System

FCC Part Section(s)	IC Part Section(s)	Test Description	Test Limit	Test Condition	Test Result	Reference
15.247(a)(2)	RSS-247 5.2 (a)	6dB Bandwidth	$\geq 500\text{kHz}$	Conducted	Pass	Section 7.2
15.247(b)(3)	RSS-247 5.4 (d)	Output Power	$\leq 30.00\text{dBm}$		Pass	Section 7.3
15.247(e)	RSS-247 5.2 (b)	Power Spectral Density	$\leq 8.00\text{dBm}/3\text{kHz}$		Pass	Section 7.4
15.247(d)	RSS-247 5.5	Out-of-Band Emissions	Conducted $\geq 20\text{dBc}$		Pass	Section 7.5
15.205 15.209	RSS-247 5.5	Spurious Emission	< FCC 15.209 limits	Radiated	Pass	Section 7.6
15.205 15.209	RSS-247 5.5	Band Edge Measurement	$\leq 74\text{dBuV}/\text{m}(\text{Peak})$ $\leq 54\text{dBuV}/\text{m}(\text{Average})$		Pass	Section 7.7
15.207	RSS-Gen 8.8	AC Conducted Emissions 150kHz - 30MHz	< FCC 15.207 limits	Line Conducted	Pass	Section 7.8

Notes:

- Determining compliance is based on the test results met the regulation limits or requirements declared by clients, and the test results don't take into account the value of measurement uncertainty.
- All modes of operation and data rates were investigated. For radiated emission test, every axis (X, Y, Z) was also verified. The test results shown in the following sections represent the worst case emissions.
- The analyzer plots shown in this section were all taken with a correction table loaded into the analyzer. The correction table was used to account for the losses of the cables and attenuators used as part of the system to connect the EUT to the analyzer at all frequencies of interest.
- All antenna port conducted emissions testing was performed on a test bench with the antenna port of the EUT connected to the spectrum analyzer through calibrated cables and attenuators.

7.2. Occupied Bandwidth Measurement

7.2.1. Test Limit

The minimum 6dB bandwidth shall be at least 500 kHz.

7.2.2. Test Procedure used

KDB 558074 D01v05r02- Section 8.2 / ANSI C63.10 6.9.3 / RSS-Gen 6.7

7.2.3. Test Setting

1. The Spectrum's automatic bandwidth measurement capability was used to perform the 6dB bandwidth measurement. The "X" dB bandwidth parameter was set to $X = 6$. The bandwidth measurement was not influenced by any intermediate power nulls in the fundamental emission.
2. Set RBW = 100 kHz
3. $VBW \geq 3 \times RBW$
4. Detector = Peak
5. Trace mode = max hold
6. Sweep = auto couple
7. Allow the trace was allowed to stabilize

P.S In 99% bandwidth, The nominal IF filter bandwidth (3 dB RBW) shall be in the range of 1% to 5% of the OBW,

7.2.4. Test Setup

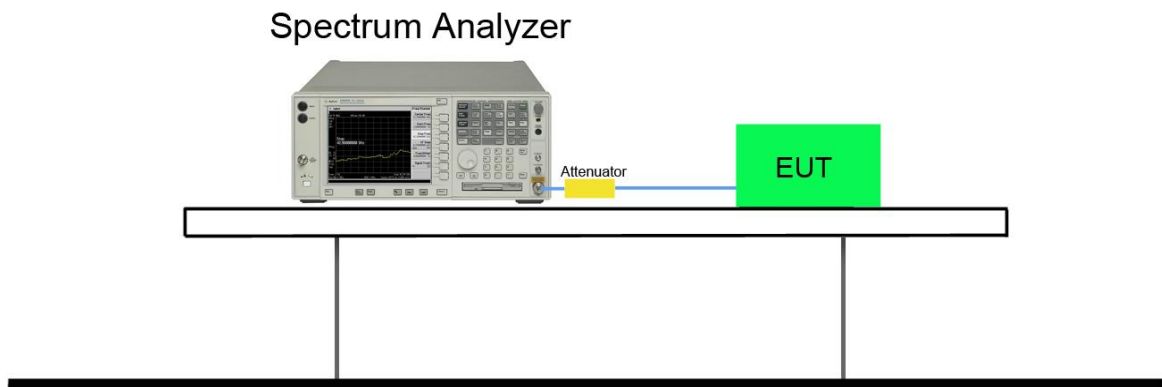

7.2.5. Test Result

Test Mode	Channel No.	Frequency (MHz)	6dB Bandwidth (MHz)	Limit (MHz)	99 % Bandwidth (MHz)	Result
LE-1Mbps	00	2402	0.6929	≥ 0.5	1.0624	Pass
	19	2440	0.7114	≥ 0.5	1.0734	Pass
	39	2480	0.7094	≥ 0.5	1.0712	Pass

6dB Bandwidth:

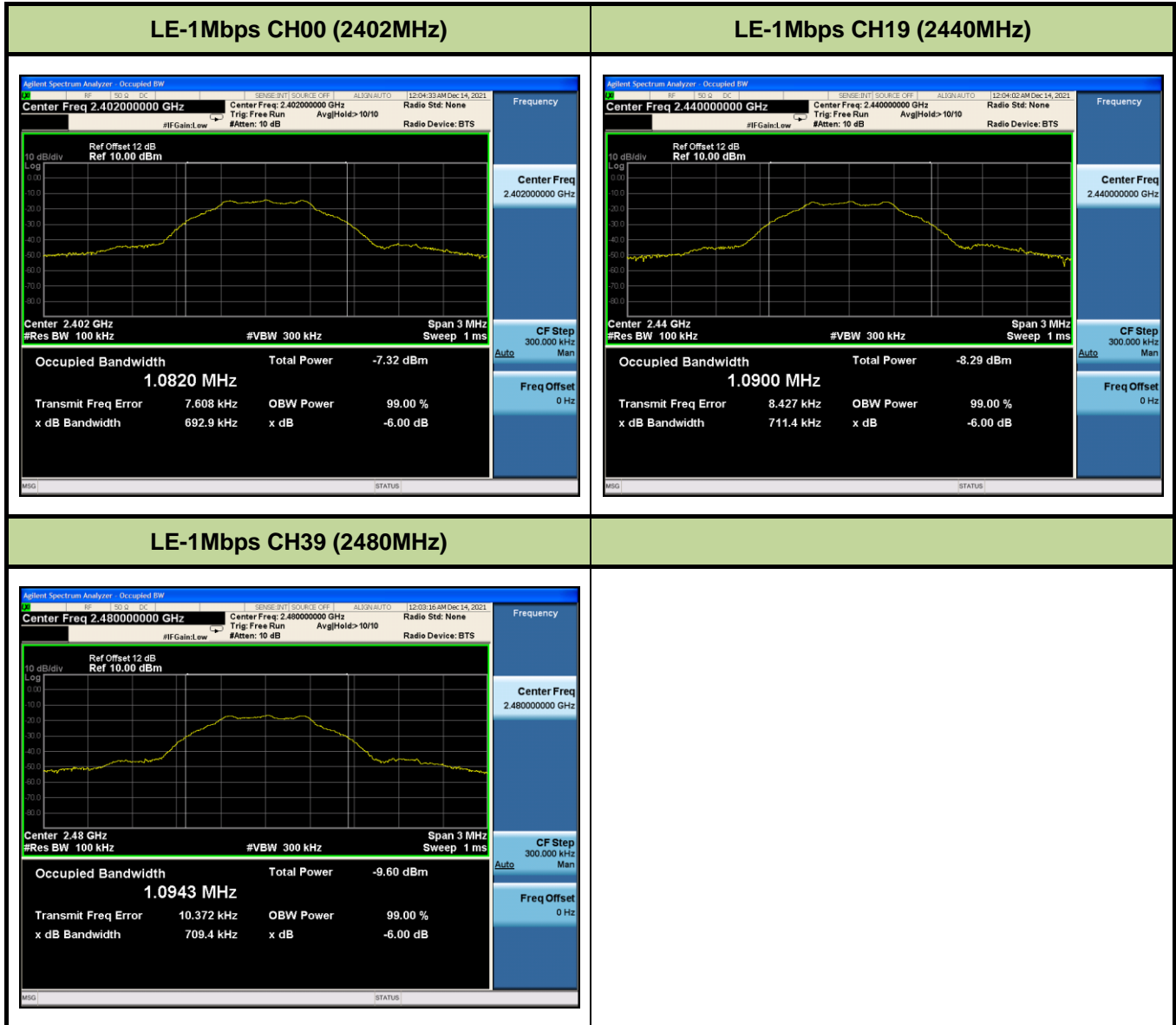

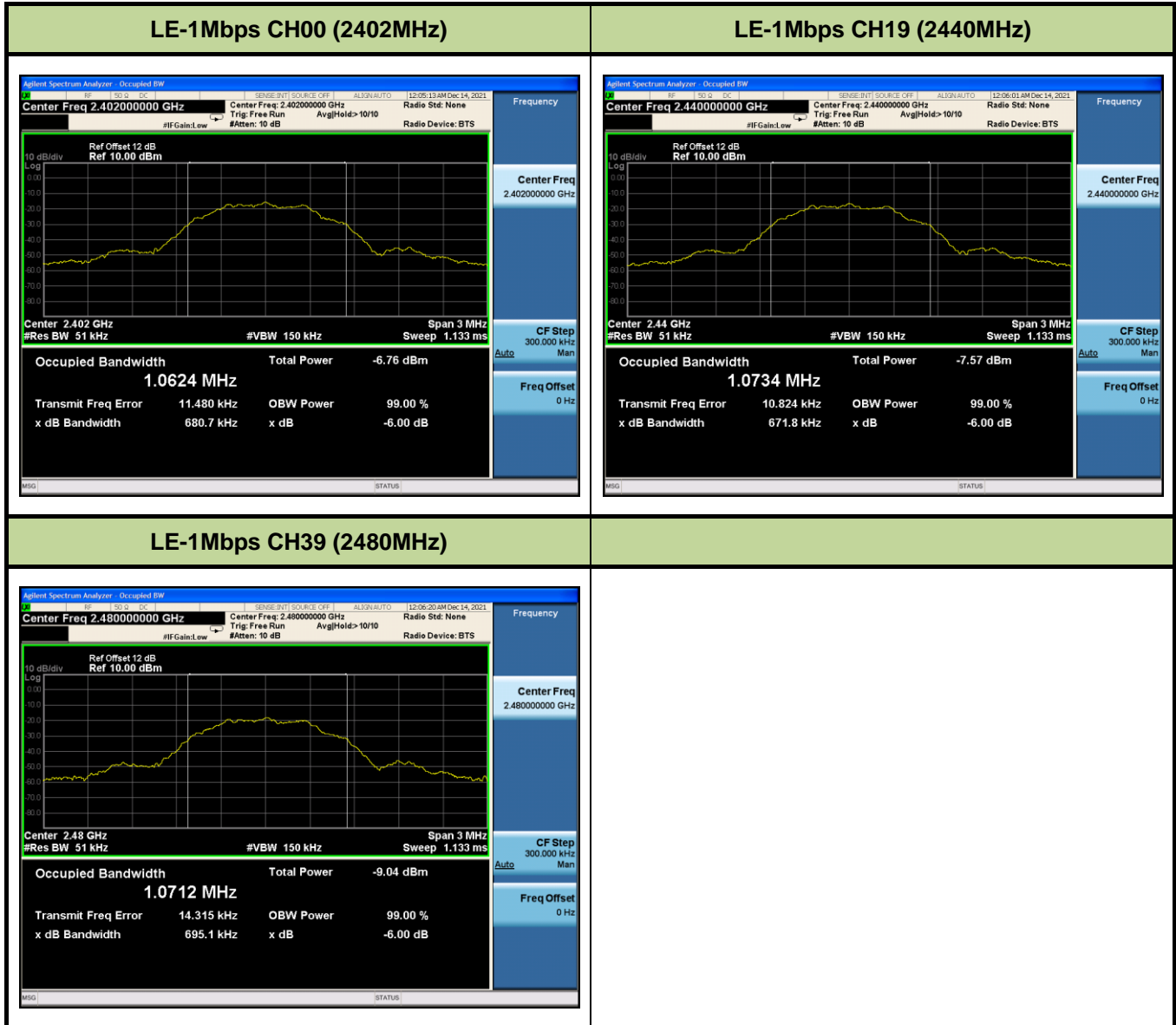
99% Bandwidth :

7.3. Output Power Measurement

7.3.1. Test Limit

The maximum out power shall be less 1 Watt (30dBm).

7.3.2. Test Procedure Used

KDB 558074 D01v05r02 - Section 8.3.1 & 8.3.2

7.3.3. Test Setting

Peak Power Measurement

The maximum peak conducted output power may be measured using a broadband peak RF power meter. The power meter shall have a video bandwidth that is greater than or equal to the DTS bandwidth and shall utilize a fast-responding diode detector.

Average Power Measurement

Average power measurements were performed only when the EUT was transmitting at its maximum power control level using a broadband power meter with a pulse sensor. The power meter implemented triggering and gating capabilities which were set up such that power measurements were recorded only during the ON time of the transmitter. The trace was averaged over 100 traces to obtain the final measured average power.

7.3.4. Test Setup

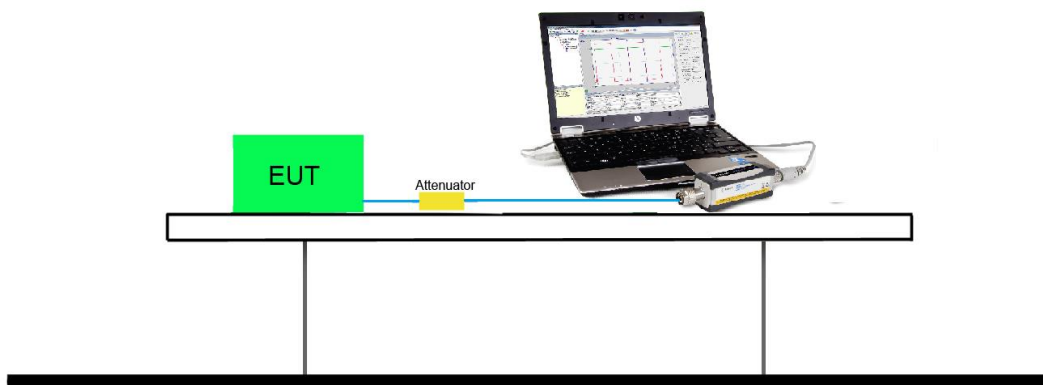

7.3.5. Test Result of Output Power

Test Mode	Channel No.	Frequency (MHz)	Peak Power (dBm)	Peak Power Limit (dBm)	EIRP Limit (dBm)
LE-1Mbps	00	2402	-13.809	< 30	< 36
	19	2440	-14.730	< 30	< 36
	39	2480	-16.099	< 30	< 36

Note: Output power = Reading value on power meter + cable loss.

7.4. Power Spectral Density Measurement

7.4.1. Test Limit

The maximum permissible power spectral density is 8dBm in any 3 kHz band.

7.4.2. Test Procedure Used

KDB 558074 D01v05r02 - Section 8.4 Method PKPSD

7.4.3. Test Setting

This procedure shall be used if maximum peak conducted output power was used to demonstrate compliance, and is optional if the maximum conducted (average) output power was used to demonstrate compliance.

- a) Set analyzer center frequency to DTS channel center frequency.
- b) Set the span to 1.5 times the DTS bandwidth.
- c) Set the RBW to: 3 kHz.
- d) Set the VBW $\geq 3^* RBW$.
- e) Detector = peak.
- f) Sweep time = auto couple.
- g) Trace mode = max hold.
- h) Allow trace to fully stabilize.
- i) Use the peak marker function to determine the maximum amplitude level within the RBW.

7.4.4. Test Setup

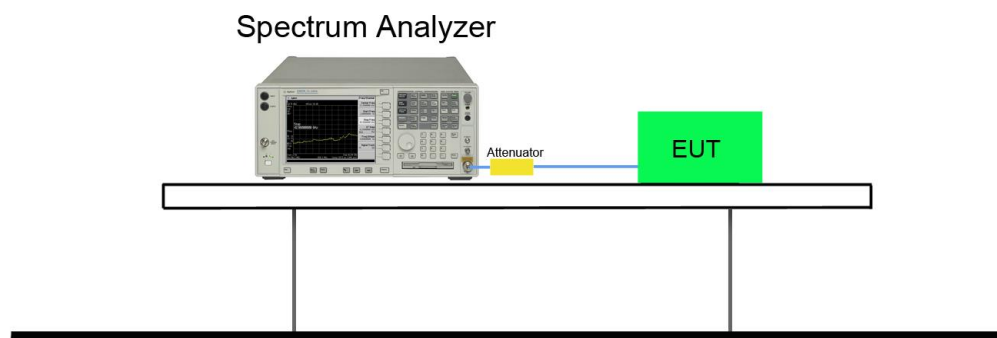

7.4.5. Test Result

Test Mode	Channel No.	Frequency (MHz)	PSD (dBm)	Limit (dBm)	Result
LE-1Mbps	00	2402	-28.597	≤ 8	Pass
	19	2440	-29.513	≤ 8	Pass
	39	2480	-30.846	≤ 8	Pass

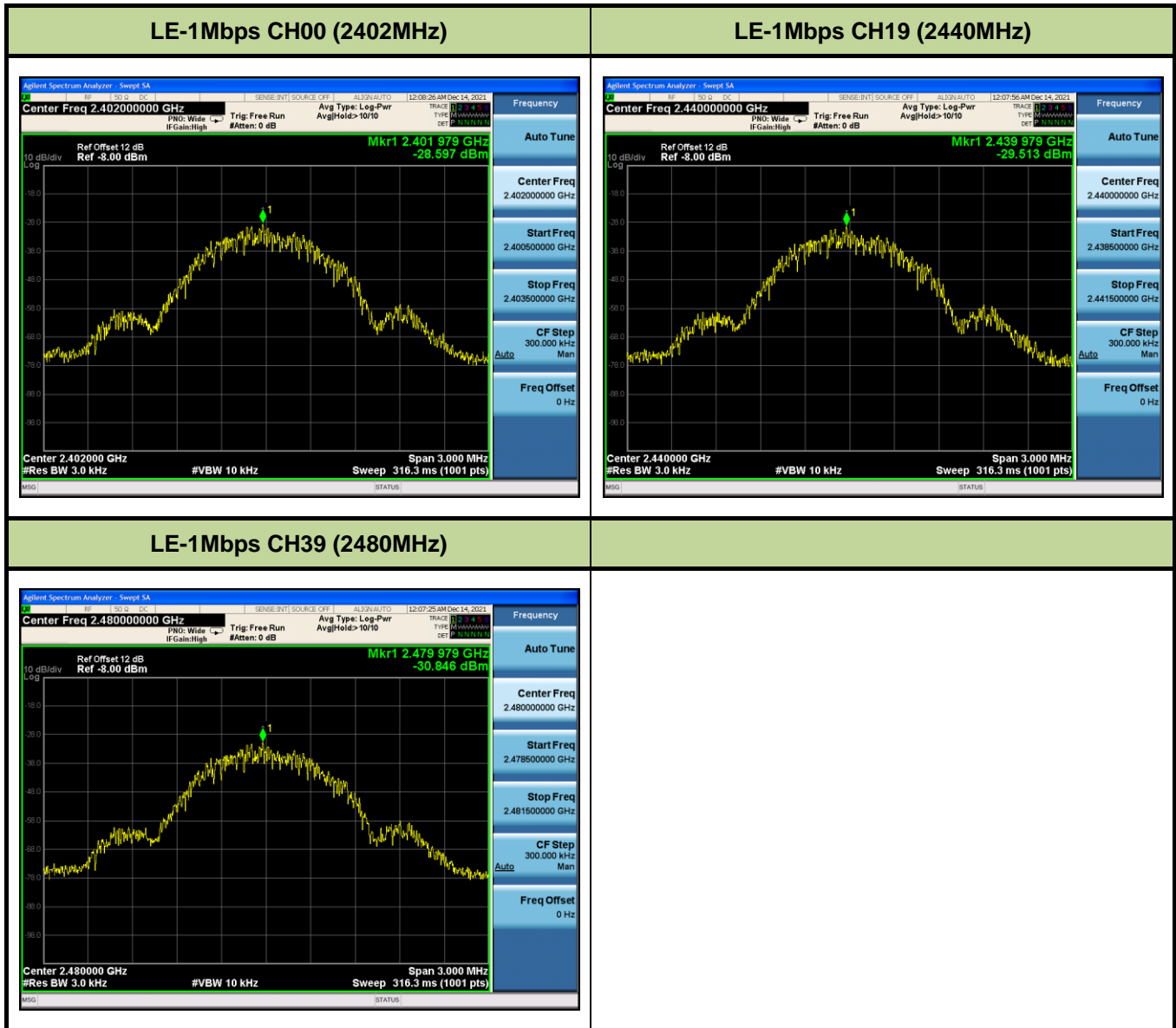

7.5. Out-of-Band Spurious Emissions Emissions Measurement

7.5.1. Test Limit

In any 100 kHz bandwidth outside the frequency band in which the spread spectrum or digitally modulated intentional radiator is operating, the radio frequency power that is produced by the intentional radiator shall be at least 20 dB below that in the 100 kHz bandwidth within the band that contains the highest level of the desired power, based on RF conducted measurement, provided the transmitter demonstrates compliance with the peak conducted power limits.

7.5.2. Test Procedure Used

KDB 558074 D01v05r02- Section 8.5 & 8.6

7.5.3. Test Settling

- (a) Set instrument center frequency to DTS channel center frequency
- (b) Set the span to ≥ 1.5 times the DTS bandwidth
- (c) Set the RBW = 100 kHz
- (d) Set the VBW $\geq 3 \times$ RBW
- (e) Detector = peak
- (f) Sweep time = auto couple
- (g) Trace mode = max hold
- (h) Allow trace to fully stabilize

7.5.4. Test Setup

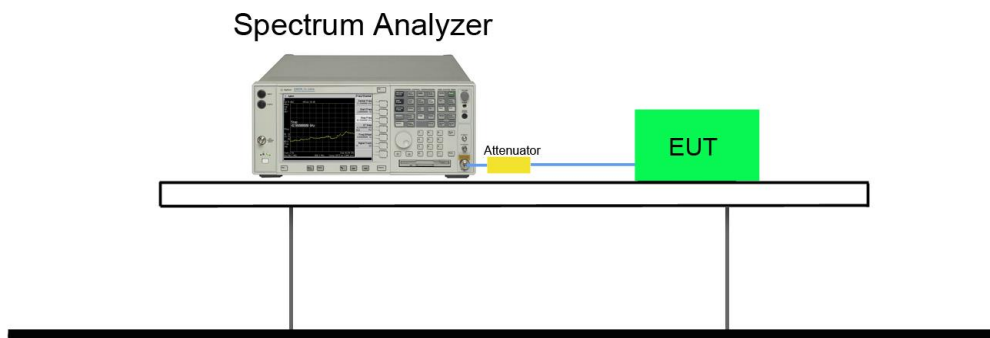

7.5.5. Test Result

Test Mode	Channel No.	Frequency (MHz)	Limit	Result
LE-1Mbps	00	2402	20dBc	Pass
	19	2440	20dBc	Pass
	39	2480	20dBc	Pass

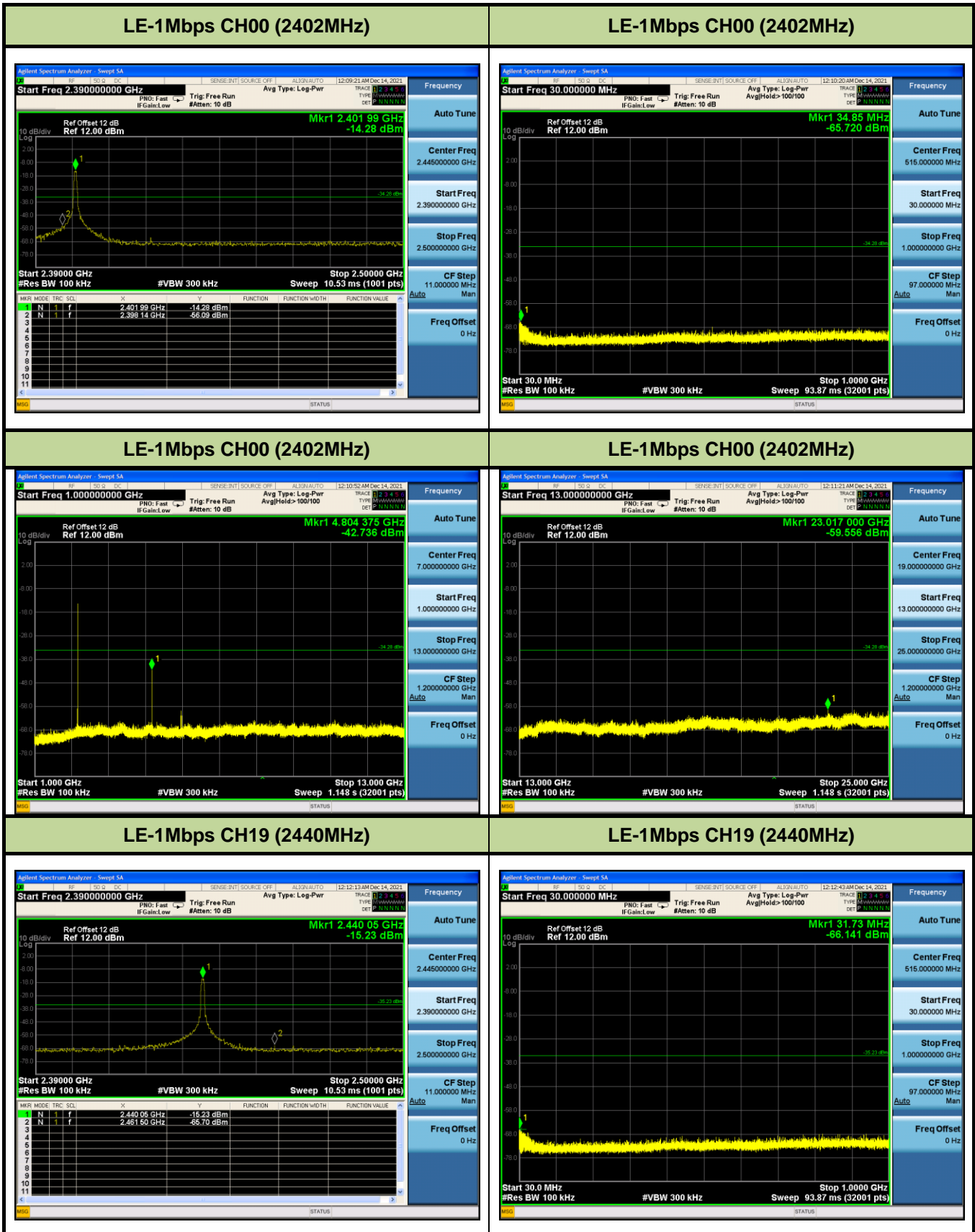

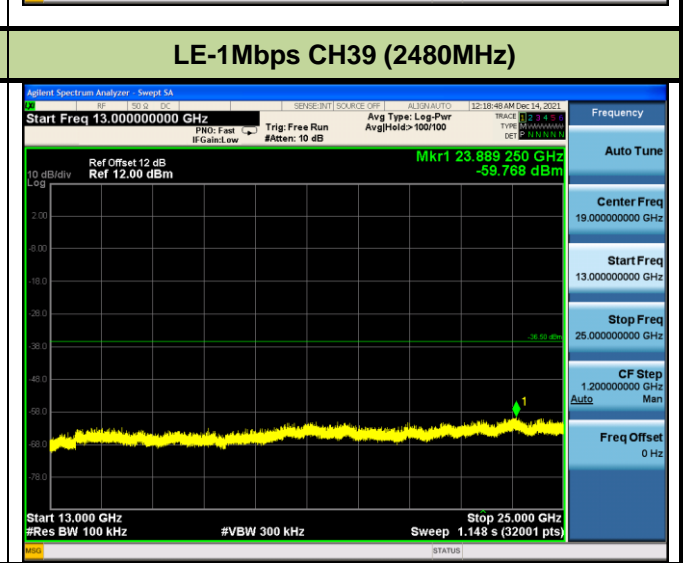
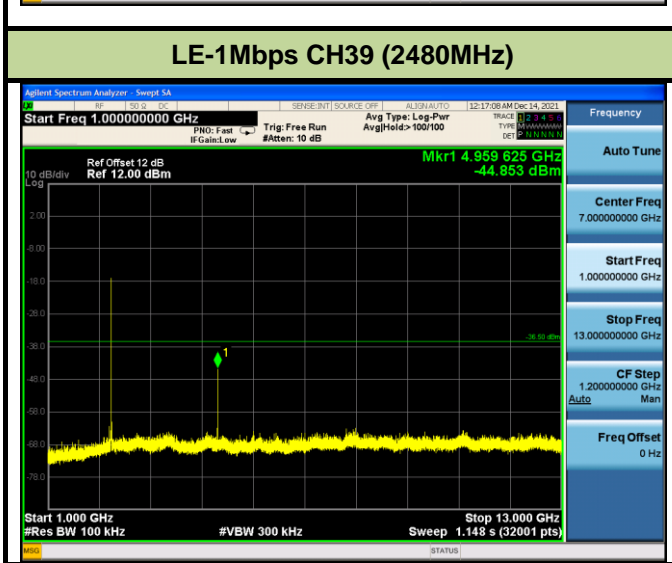
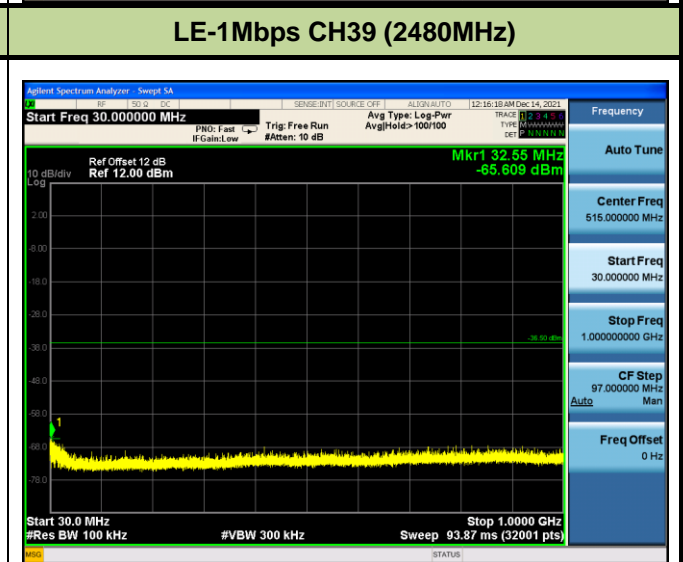
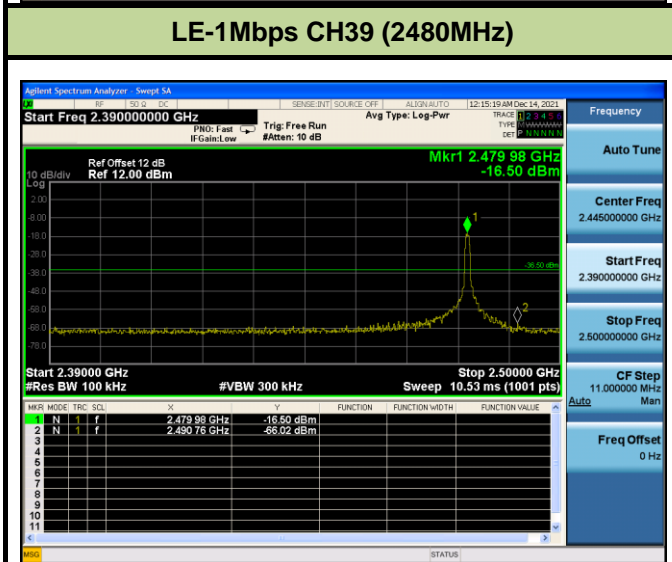
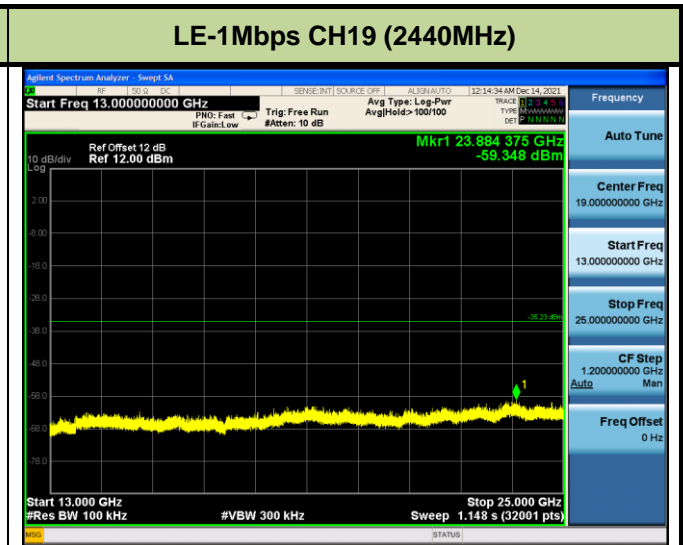
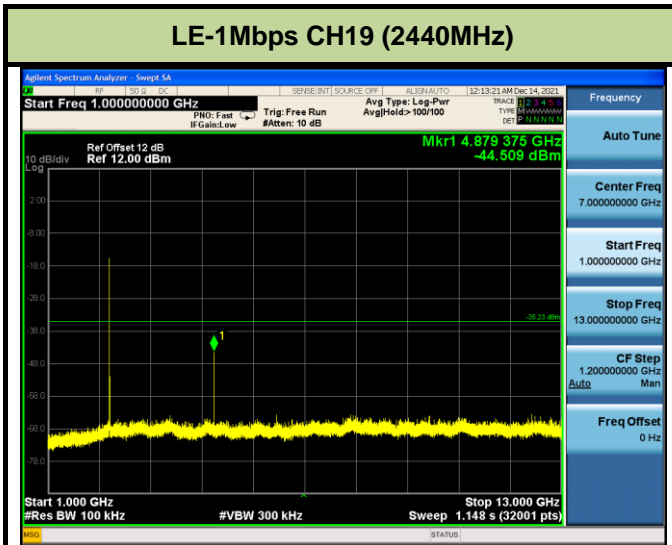

7.6. Radiated Spurious Emission Measurement

7.6.1. Test Limit

All out of band emissions appearing in a restricted band as specified in Section 15.205 of the Title 47 CFR must not exceed the limits shown in Table per Section 15.209/ IC RSS-Gen Table 7.

FCC Part 15 Subpart C Paragraph 15.209 / IC RSS-Gen Table 5, 6		
Frequency [MHz]	Field Strength [V/m]	Measured Distance [Meters]
0.009 - 0.490	2400/F (kHz)	300
0.490 - 1.705	24000/F (kHz)	30
1.705 - 30	30	30
30 - 88	100	3
88 - 216	150	3
216 - 960	200	3
Above 960	500	3

7.6.2. Test Procedure Used

ANSI C63.10- Section 11.12.2.3 (quasi-peak measurements)

ANSI C63.10- Section 11.12.2.4 (peak power measurements)

ANSI C63.10- Section 11.12.2.5 (average power measurements)

7.6.3. Test Setting

Peak Field Strength Measurements

1. Analyzer center frequency was set to the frequency of the radiated spurious emission of interest
2. RBW = as specified in Table 1
3. VBW = 3MHz
4. Detector = peak
5. Sweep time = auto couple

6. Trace mode = max hold

7. Trace was allowed to stabilize

Table 1 - RBW as a function of frequency

Frequency	RBW
9 ~ 150 kHz	200 ~ 300 Hz
0.15 ~ 30 MHz	9 ~ 10 kHz
30 ~ 1000 MHz	100 ~ 120 kHz
> 1000 MHz	1 MHz

Average Field Strength Measurements

1. Analyzer center frequency was set to the frequency of the radiated spurious emission of interest

2. RBW = 1MHz

3. VBW \geq 1/T

4. De As an alternative, the instrument may be set to linear detector mode. Ensure that video filtering is applied in linear voltage domain (rather than in a log or dB domain). Some instruments require linear display mode in order to accomplish this. Others have a setting for Average-VBW Type, which can be set to "Voltage" regardless of the display mode

5. Detector = Peak

6. Sweep time = auto

7. Trace mode = max hold

8. Allow max hold to run for at least 50 times (1/duty cycle) traces

7.6.4. Test Setup

9kHz ~ 30MHz Test Setup:

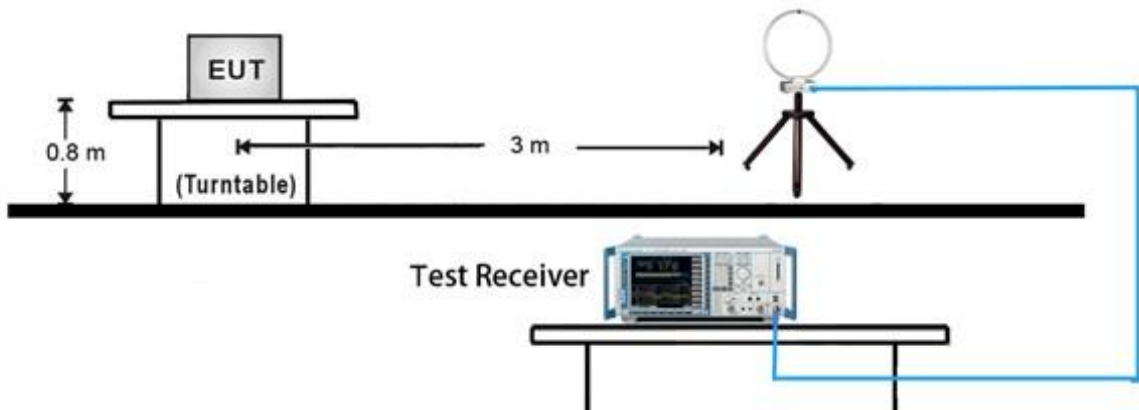

30MHz ~ 1GHz Test Setup:

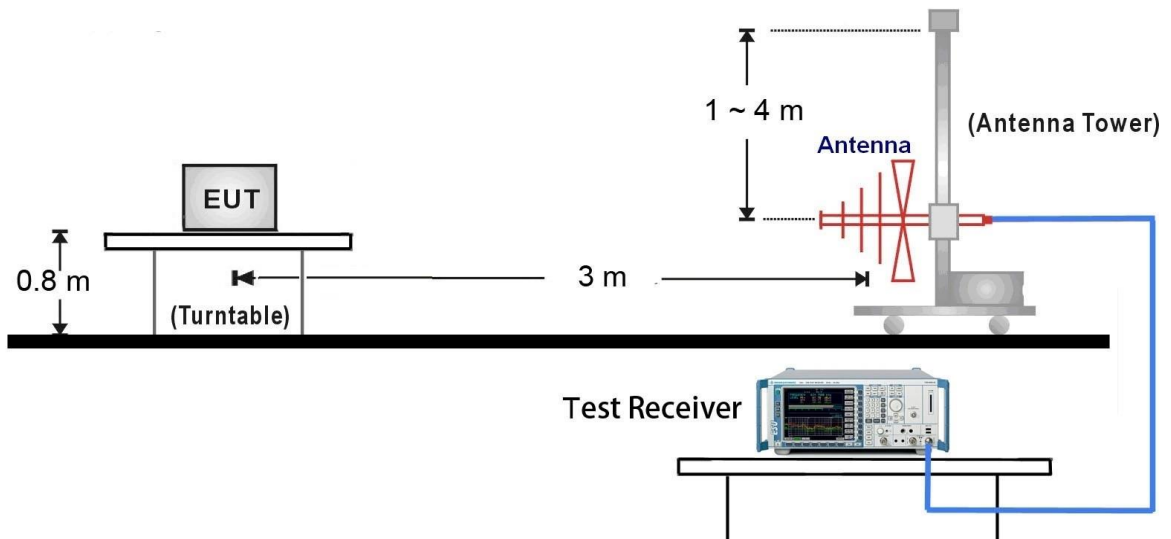

1GHz ~ 18GHz Test Setup:

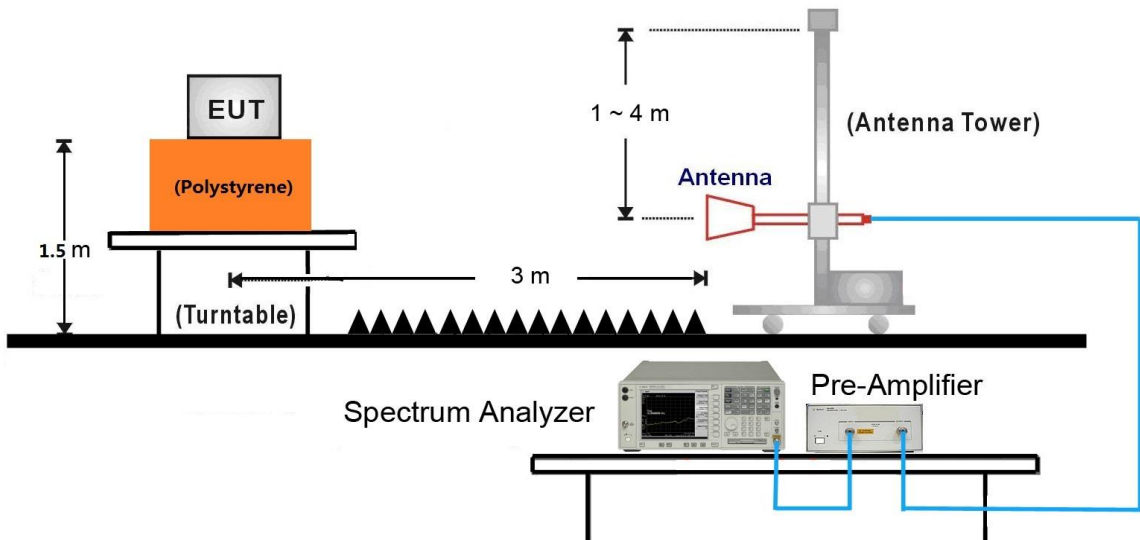

18GHz ~25GHz Test Setup:

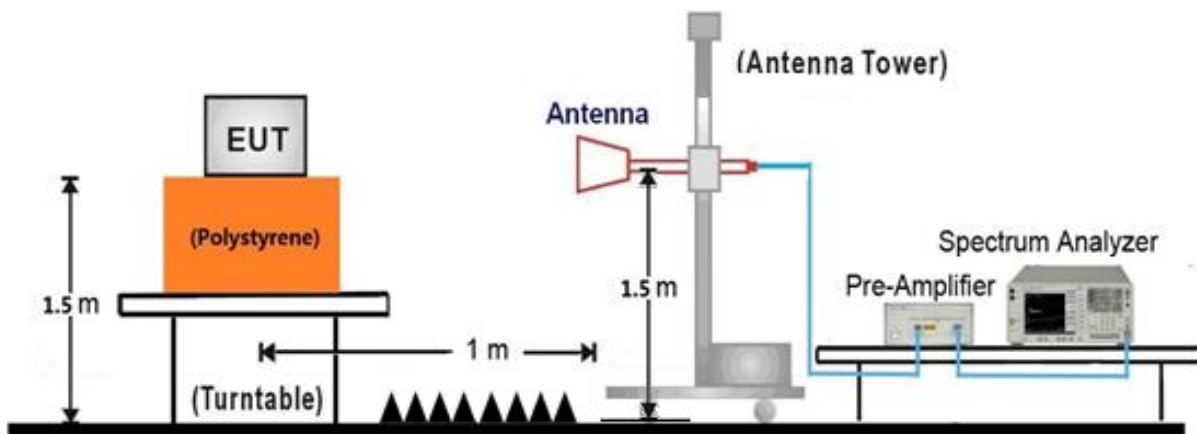

7.6.5. Test Result

EUT	S2.2 TITANIUM	Date of Test	2021-12-09
Factor	VULB 9162	Temp. / Humidity	23°C /62%
Polarity	Horizontal	Site / Test Engineer	AC2 / Volvo
Test Mode	BLE_TX_1Mbps_CH 19_TITANIUM	Test Voltage	By Notebook PC

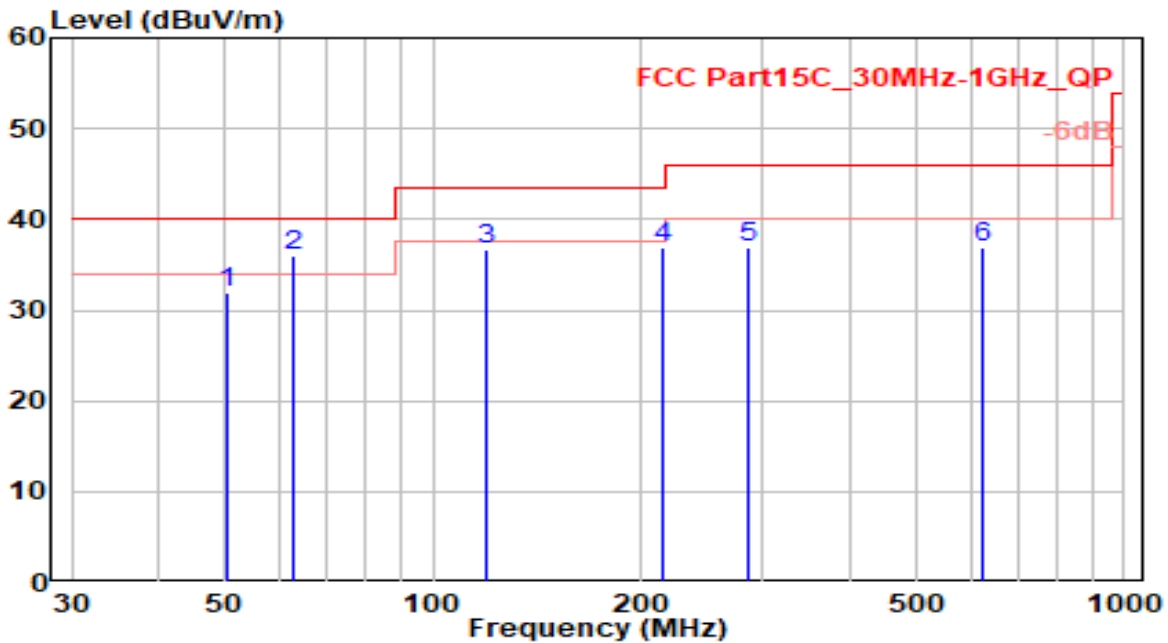

No	Frequency (MHz)	Reading (dBUV)	C.F (dB/m)	Measurement (dBUV/m)	Margin (dB)	Limit (dBUV/m)	Height (cm)	Angle (deg)	Remark (QP/PK/AV)
1	50.370	10.80	21.18	31.98	-8.02	40.00	305	305	QP
2	* 62.980	17.53	18.56	36.09	-3.91	40.00	100	225	QP
3	119.240	19.42	17.31	36.73	-6.77	43.50	100	80	QP
4	215.270	18.45	18.50	36.95	-6.55	43.50	100	150	QP
5	287.050	16.35	20.66	37.02	-8.98	46.00	100	255	QP
6	622.670	9.37	27.52	36.89	-9.11	46.00	100	35	QP

Note:

1. " *", means this data is the worst emission level.
2. C.F (Correction Factor) = Antenna Factor (dB)+ Cable Loss (dB).
3. Measurement (dBUV/m) = Reading(dBUV) + C.F (Correction Factor).
4. The emission levels of other frequencies are very lower than the limit and not show in test report.

EUT	S2.2 TITANIUM	Date of Test	2021-12-09
Factor	VULB 9162	Temp. / Humidity	23°C /62%
Polarity	Vertical	Site / Test Engineer	AC2 / Volvo
Test Mode	BLE_TX_1Mbps_CH 19_TITANIUM	Test Voltage	By Notebook PC

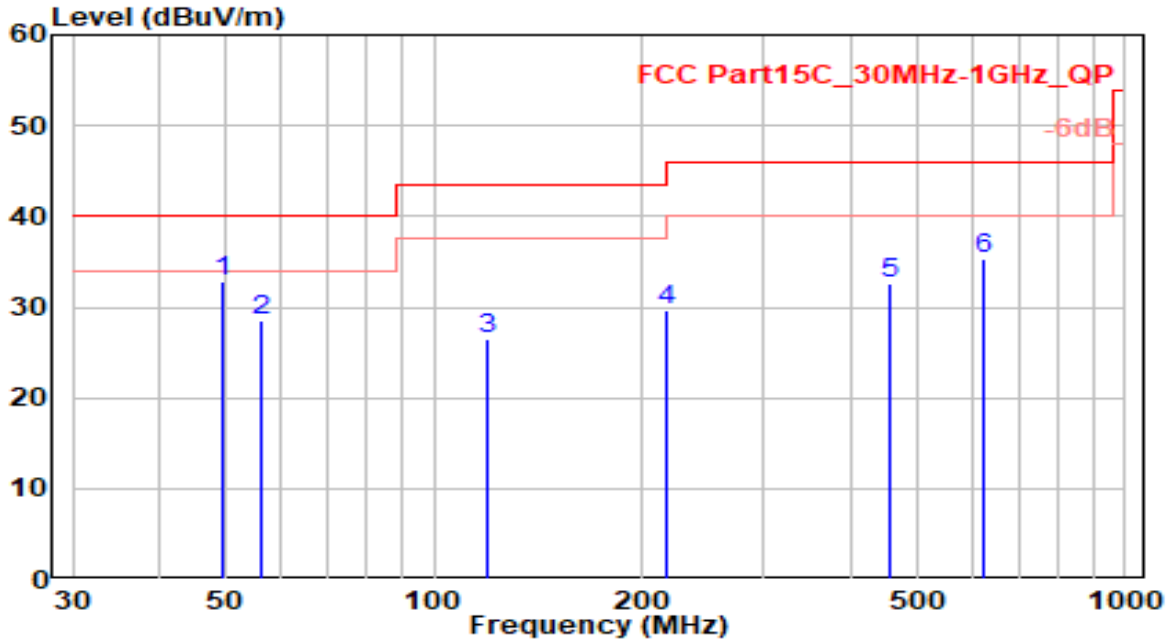

No	Frequency (MHz)	Reading (dBuV)	C.F (dB/m)	Measurement (dBuV/m)	Margin (dB)	Limit (dBuV/m)	Height (cm)	Angle (deg)	Remark (QP/PK/AV)
1	* 49.400	11.70	21.23	32.93	-7.07	40.00	100	245	QP
2	56.190	8.20	20.27	28.47	-11.53	40.00	100	235	QP
3	119.240	9.25	17.31	26.55	-16.95	43.50	100	40	QP
4	216.240	11.16	18.54	29.70	-16.30	46.00	100	125	QP
5	455.830	8.46	24.22	32.68	-13.32	46.00	100	330	QP
6	623.640	7.88	27.53	35.41	-10.59	46.00	100	155	QP

Note:

1. " *", means this data is the worst emission level.
2. C.F (Correction Factor) = Antenna Factor (dB)+ Cable Loss (dB).
3. Measurement (dBuV/m) = Reading(dBuV) + C.F (Correction Factor).
4. The emission levels of other frequencies are very lower than the limit and not show in test report.

EUT	S2.2 STEEL-ALU	Date of Test	2021-12-09
Factor	VULB 9162	Temp. / Humidity	23°C /62%
Polarity	Horizontal	Site / Test Engineer	AC2 / Volvo
Test Mode	BLE_TX_1Mbps_CH 19_STEEL-ALU	Test Voltage	By Notebook PC

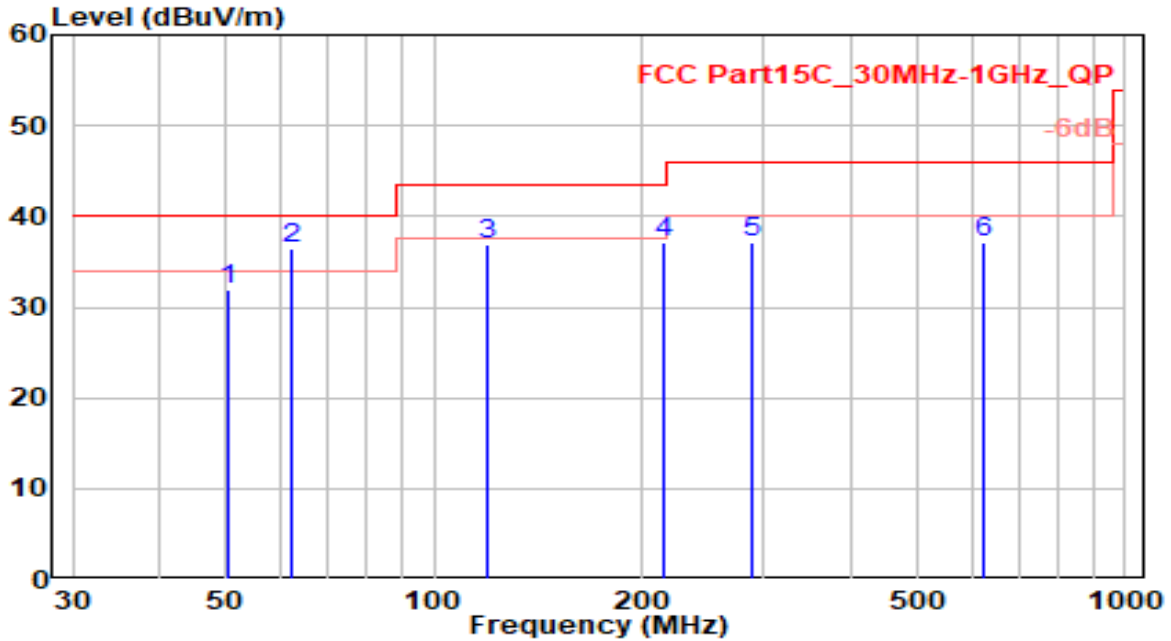

No	Frequency (MHz)	Reading (dBuV)	C.F (dB/m)	Measurement (dBuV/m)	Margin (dB)	Limit (dBuV/m)	Height (cm)	Angle (deg)	Remark (QP/PK/AV)
1	50.146	10.70	21.22	31.92	-8.08	40.00	305	310	QP
2	* 62.216	17.56	18.85	36.41	-3.59	40.00	100	230	QP
3	119.447	19.52	17.28	36.81	-6.69	43.50	100	85	QP
4	215.125	18.58	18.49	37.08	-6.42	43.50	100	155	QP
5	287.418	16.45	20.67	37.12	-8.88	46.00	100	260	QP
6	622.415	9.52	27.52	37.04	-8.96	46.00	100	30	QP

Note:

1. " *", means this data is the worst emission level.
2. C.F (Correction Factor) = Antenna Factor (dB)+ Cable Loss (dB).
3. Measurement (dBuV/m) = Reading(dBuV) + C.F (Correction Factor).
4. The emission levels of other frequencies are very lower than the limit and not show in test report.

EUT	S2.2 STEEL-ALU	Date of Test	2021-12-09
Factor	VULB 9162	Temp. / Humidity	23°C /62%
Polarity	Vertical	Site / Test Engineer	AC2 / Volvo
Test Mode	BLE_TX_1Mbps_CH 19_STEEL-ALU	Test Voltage	By Notebook PC

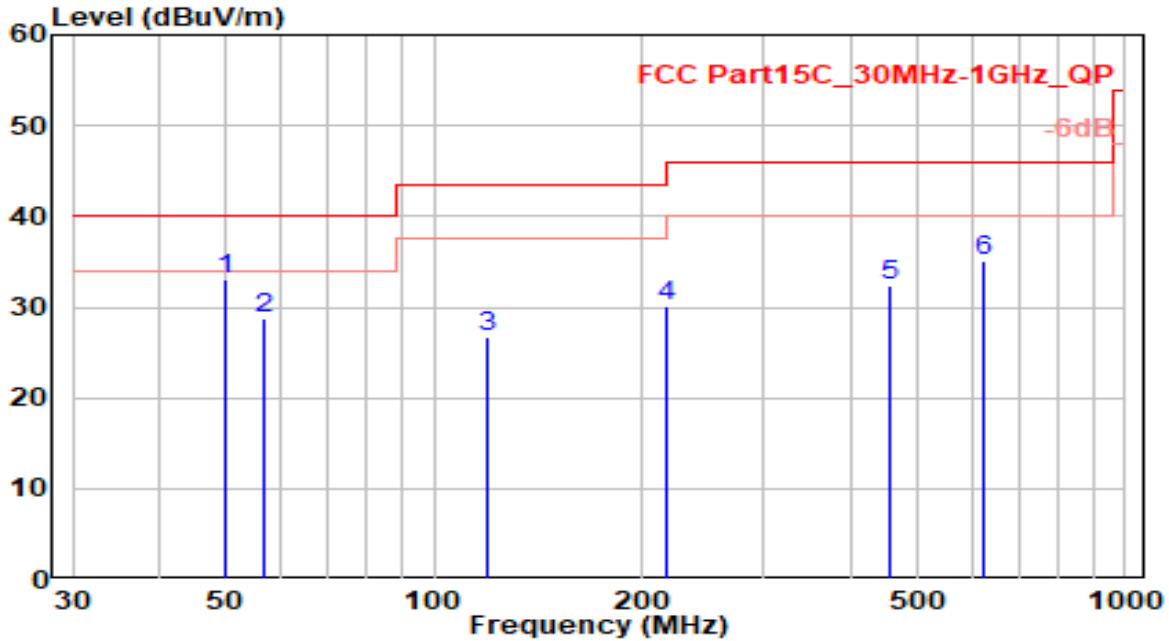

No	Frequency (MHz)	Reading (dBuV)	C.F (dB/m)	Measurement (dBuV/m)	Margin (dB)	Limit (dBuV/m)	Height (cm)	Angle (deg)	Remark (QP/PK/AV)
1	* 49.867	11.80	21.24	33.04	-6.96	40.00	100	250	QP
2	56.596	8.56	20.21	28.78	-11.22	40.00	100	230	QP
3	119.145	9.47	17.32	26.79	-16.71	43.50	100	35	QP
4	216.964	11.46	18.57	30.03	-15.97	46.00	100	120	QP
5	455.256	8.25	24.20	32.45	-13.55	46.00	100	335	QP
6	623.156	7.55	27.53	35.07	-10.93	46.00	100	160	QP

Note:

1. " *", means this data is the worst emission level.
2. C.F (Correction Factor) = Antenna Factor (dB)+ Cable Loss (dB).
3. Measurement (dBuV/m) = Reading(dBuV) + C.F (Correction Factor).
4. The emission levels of other frequencies are very lower than the limit and not show in test report.

EUT	S2.2 TITANIUM	Date of Test	2021-12-09
Factor	VULB 9162	Temp. / Humidity	23°C /62%
Polarity	Horizontal	Site / Test Engineer	AC2 / Volvo
Test Mode	BLE_RX_1Mbps_CH 19_TITANIUM	Test Voltage	By Notebook PC

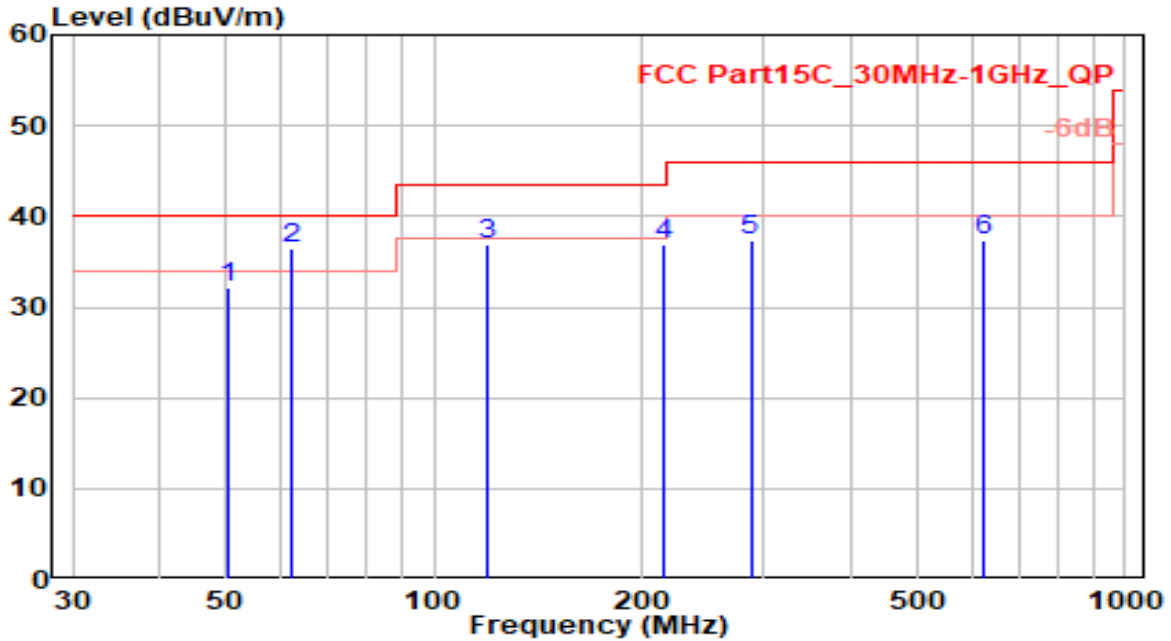

No	Frequency (MHz)	Reading (dBuV)	C.F (dB/m)	Measurement (dBuV/m)	Margin (dB)	Limit (dBuV/m)	Height (cm)	Angle (deg)	Remark (QP/PK/AV)
1	50.156	10.90	21.22	32.12	-7.88	40.00	305	310	QP
2	* 62.156	17.57	18.87	36.45	-3.55	40.00	100	220	QP
3	119.145	19.48	17.32	36.80	-6.70	43.50	100	85	QP
4	215.416	18.48	18.50	36.98	-6.52	43.50	100	145	QP
5	287.126	16.75	20.67	37.41	-8.59	46.00	100	250	QP
6	622.424	9.75	27.52	37.26	-8.74	46.00	100	40	QP

Note:

1. " *", means this data is the worst emission level.
2. C.F (Correction Factor) = Antenna Factor (dB)+ Cable Loss (dB).
3. Measurement (dBuV/m) = Reading(dBuV) + C.F (Correction Factor).
4. The emission levels of other frequencies are very lower than the limit and not show in test report.

EUT	S2.2 TITANIUM	Date of Test	2021-12-09
Factor	VULB 9162	Temp. / Humidity	23°C /62%
Polarity	Vertical	Site / Test Engineer	AC2 / Volvo
Test Mode	BLE_RX_1Mbps_CH 19_TITANIUM	Test Voltage	By Notebook PC

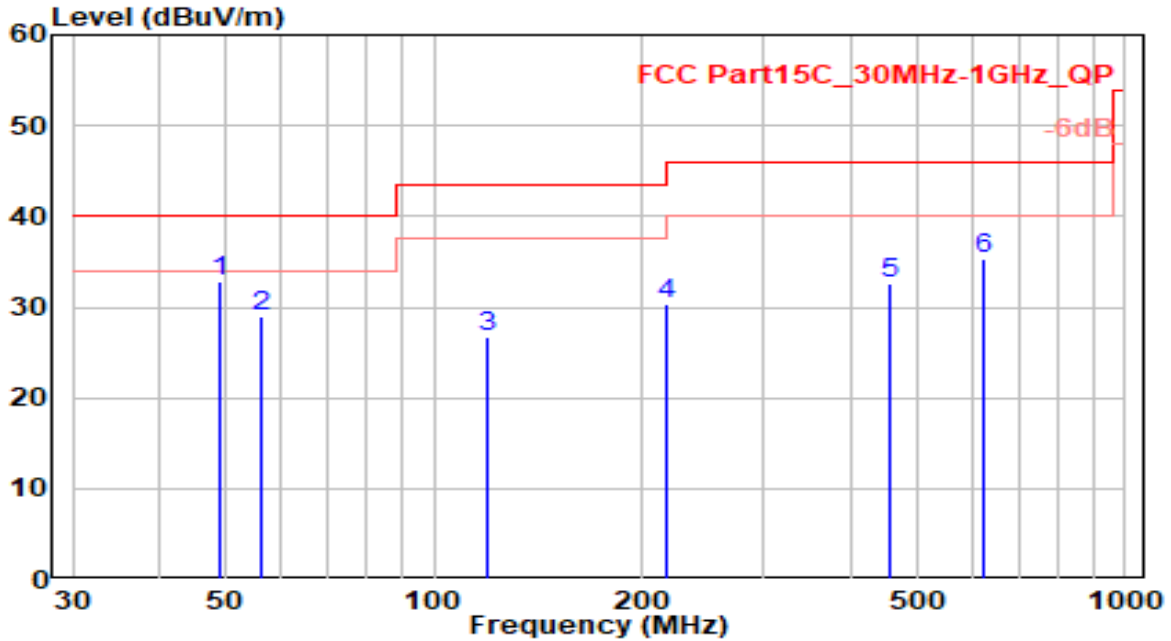

No	Frequency (MHz)	Reading (dBuV)	C.F (dB/m)	Measurement (dBuV/m)	Margin (dB)	Limit (dBuV/m)	Height (cm)	Angle (deg)	Remark (QP/PK/AV)
1	* 49.126	11.60	21.22	32.82	-7.18	40.00	100	240	QP
2	56.126	8.76	20.28	29.04	-10.96	40.00	100	240	QP
3	119.548	9.55	17.27	26.82	-16.68	43.50	100	45	QP
4	216.154	11.86	18.53	30.39	-15.61	46.00	100	120	QP
5	455.415	8.45	24.21	32.66	-13.34	46.00	100	335	QP
6	623.489	7.69	27.53	35.22	-10.78	46.00	100	160	QP

Note:

1. " *", means this data is the worst emission level.
2. C.F (Correction Factor) = Antenna Factor (dB)+ Cable Loss (dB).
3. Measurement (dBuV/m) = Reading(dBuV) + C.F (Correction Factor).
4. The emission levels of other frequencies are very lower than the limit and not show in test report.

EUT	S2.2 STEEL-ALU	Date of Test	2021-12-09
Factor	VULB 9162	Temp. / Humidity	23°C /62%
Polarity	Horizontal	Site / Test Engineer	AC2 / Volvo
Test Mode	BLE_RX_1Mbps_CH 19_STEEL-ALU	Test Voltage	By Notebook PC

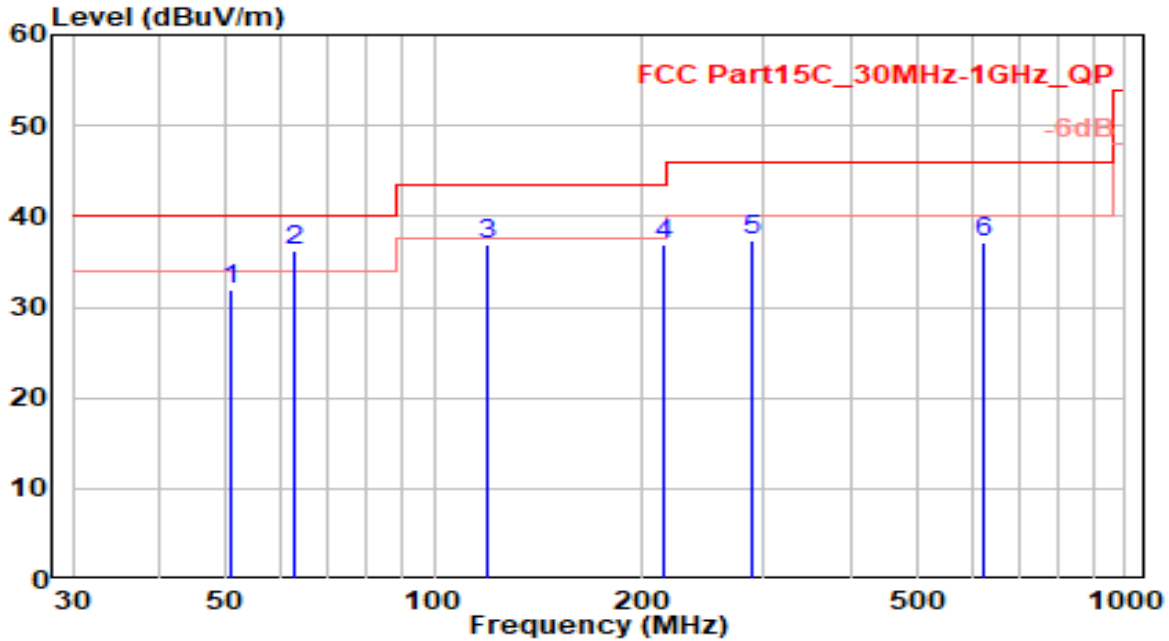

No	Frequency (MHz)	Reading (dBuV)	C.F (dB/m)	Measurement (dBuV/m)	Margin (dB)	Limit (dBuV/m)	Height (cm)	Angle (deg)	Remark (QP/PK/AV)
1	50.749	10.70	21.12	31.82	-8.18	40.00	305	320	QP
2	* 62.545	17.53	18.73	36.25	-3.75	40.00	100	215	QP
3	119.146	19.55	17.32	36.87	-6.63	43.50	100	90	QP
4	215.345	18.45	18.50	36.95	-6.55	43.50	100	140	QP
5	287.545	16.74	20.68	37.42	-8.58	46.00	100	245	QP
6	622.348	9.54	27.52	37.06	-8.94	46.00	100	35	QP

Note:

1. " *", means this data is the worst emission level.
2. C.F (Correction Factor) = Antenna Factor (dB)+ Cable Loss (dB).
3. Measurement (dBuV/m) = Reading(dBuV) + C.F (Correction Factor).
4. The emission levels of other frequencies are very lower than the limit and not show in test report.

EUT	S2.2 STEEL-ALU	Date of Test	2021-12-09
Factor	VULB 9162	Temp. / Humidity	23°C /62%
Polarity	Vertical	Site / Test Engineer	AC2 / Volvo
Test Mode	BLE_RX_1Mbps_CH 19_STEEL-ALU	Test Voltage	By Notebook PC

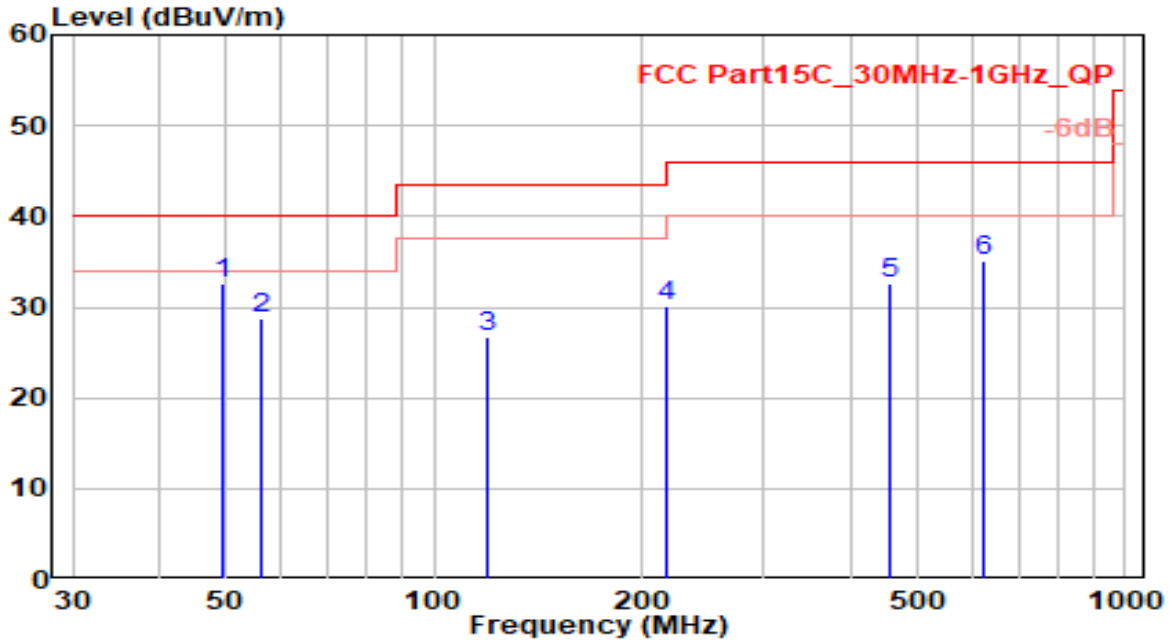

No	Frequency (MHz)	Reading (dBuV)	C.F (dB/m)	Measurement (dBuV/m)	Margin (dB)	Limit (dBuV/m)	Height (cm)	Angle (deg)	Remark (QP/PK/AV)
1	* 49.312	11.40	21.22	32.62	-7.38	40.00	100	235	QP
2	56.342	8.48	20.25	28.73	-11.27	40.00	100	235	QP
3	119.341	9.47	17.29	26.77	-16.73	43.50	100	50	QP
4	216.765	11.46	18.56	30.03	-15.97	46.00	100	115	QP
5	455.354	8.44	24.21	32.65	-13.35	46.00	100	330	QP
6	623.354	7.53	27.53	35.05	-10.95	46.00	100	165	QP

Note:

1. " *", means this data is the worst emission level.
2. C.F (Correction Factor) = Antenna Factor (dB)+ Cable Loss (dB).
3. Measurement (dBuV/m) = Reading(dBuV) + C.F (Correction Factor).
4. The emission levels of other frequencies are very lower than the limit and not show in test report.

EUT	S2.2 TITANIUM	Date of Test	2021-12-10
Factor	DRH18-E & BBHA 9170	Temp. / Humidity	23°C /62%
Polarity	Horizontal	Site / Test Engineer	AC2 / Volvo
Test Mode	BLE_TX_1Mbps_CH 0_TITANIUM	Test Voltage	By Notebook PC

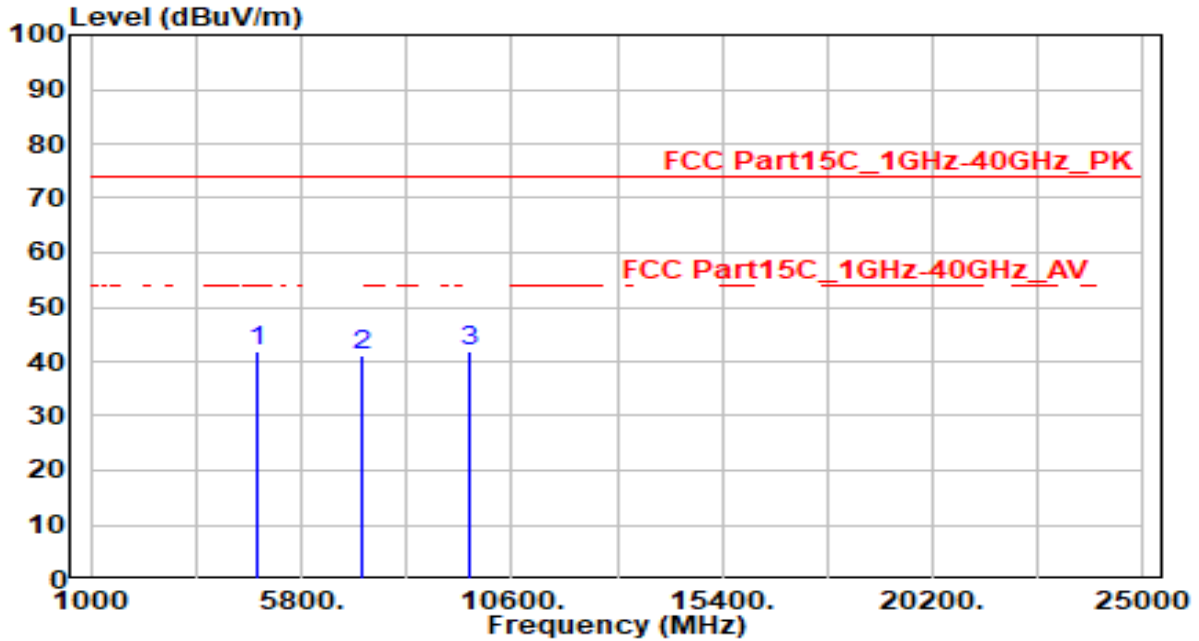

No	Frequency (MHz)	Reading (dBuV)	C.F (dB/m)	Measurement (dBuV/m)	Margin (dB)	Limit (dBuV/m)	Height (cm)	Angle (deg)	Remark (QP/PK/AV)
1	4804.000	42.15	-0.44	41.70	-32.30	74.00	150	360	Peak
2	7206.000	36.68	4.49	41.17	-32.83	74.00	150	360	Peak
3	* 9608.000	37.64	4.36	42.00	-32.00	74.00	150	360	Peak

Note:

1. " *", means this data is the worst emission level.
2. C.F (Correction Factor) = Antenna Factor (dB)+ Cable Loss (dB) – Preamplifier(dB).
3. Measurement (dBuV/m) = Reading(dBuV) + C.F (Correction Factor).
4. The emission levels of other frequencies are very lower than the limit and not show in test report.

EUT	S2.2 TITANIUM	Date of Test	2021-12-10
Factor	DRH18-E & BBHA 9170	Temp. / Humidity	23°C /62%
Polarity	Vertical	Site / Test Engineer	AC2 / Volvo
Test Mode	BLE_TX_1Mbps_CH 0_TITANIUM	Test Voltage	By Notebook PC

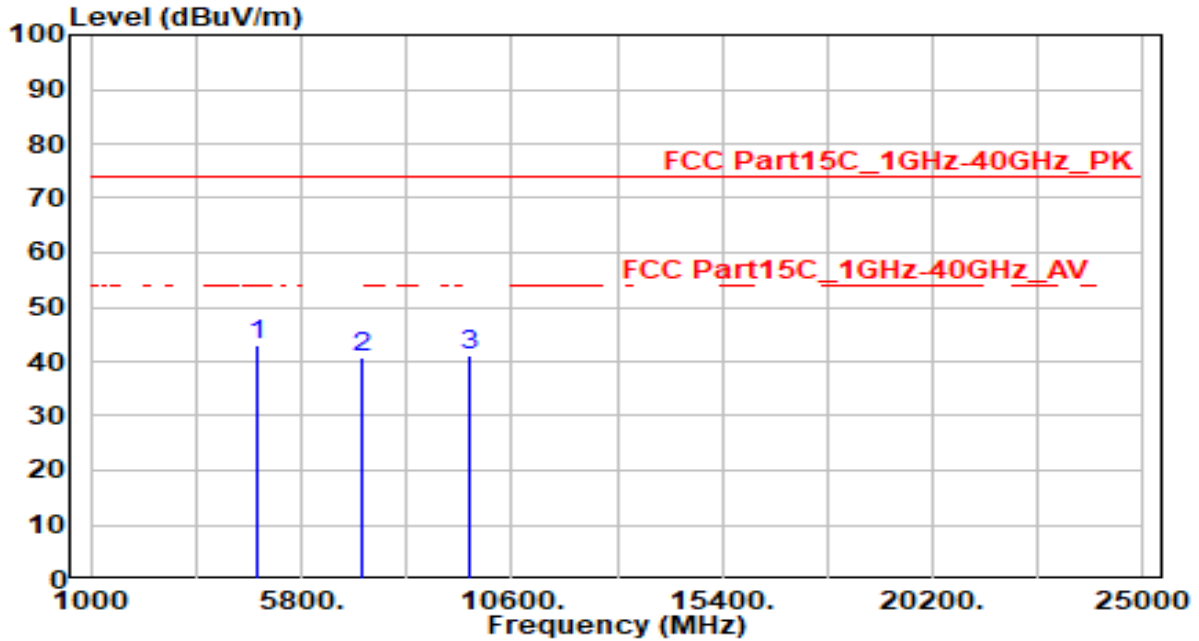

No	Frequency (MHz)	Reading (dBuV)	C.F (dB/m)	Measurement (dBuV/m)	Margin (dB)	Limit (dBuV/m)	Height (cm)	Angle (deg)	Remark (QP/PK/AV)
1	* 4804.000	43.29	-0.44	42.84	-31.16	74.00	150	360	Peak
2	7206.000	36.38	4.49	40.87	-33.13	74.00	150	360	Peak
3	9608.000	36.90	4.36	41.26	-32.74	74.00	150	360	Peak

Note:

- "*" means this data is the worst emission level.
- C.F (Correction Factor) = Antenna Factor (dB)+ Cable Loss (dB) – Preamplifier(dB).
- Measurement (dBuV/m) = Reading(dBuV) + C.F (Correction Factor).
- The emission levels of other frequencies are very lower than the limit and not show in test report.

EUT	S2.2 TITANIUM	Date of Test	2021-12-10
Factor	DRH18-E & BBHA 9170	Temp. / Humidity	23°C /62%
Polarity	Horizontal	Site / Test Engineer	AC2 / Volvo
Test Mode	BLE_TX_1Mbps_CH 19_TITANIUM	Test Voltage	By Notebook PC

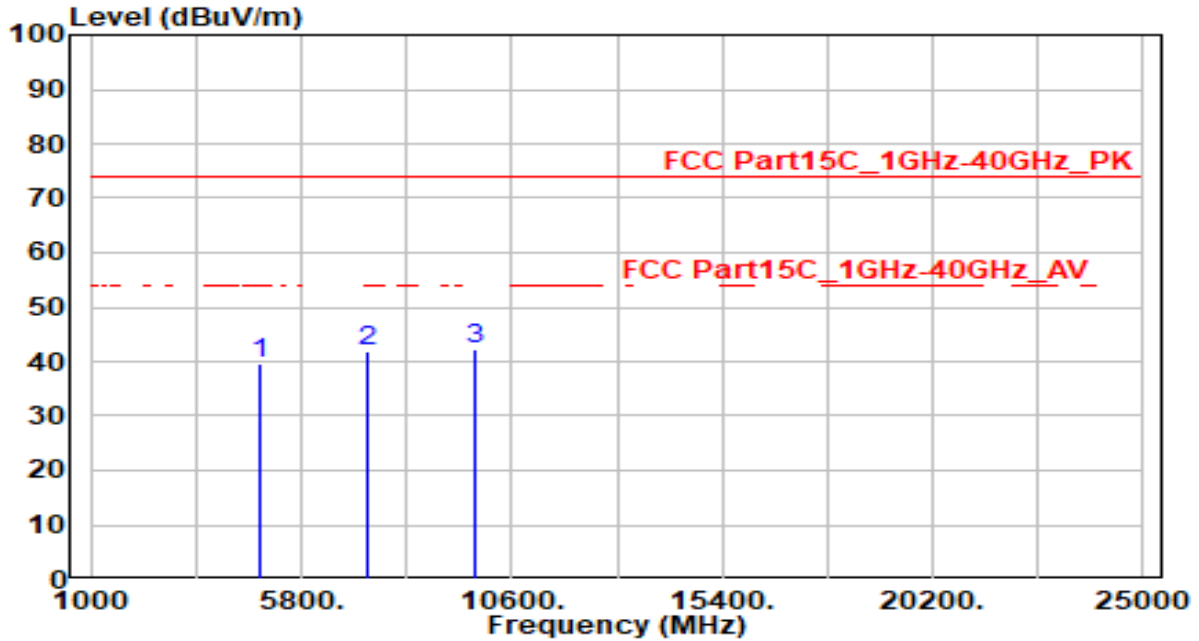

No	Frequency (MHz)	Reading (dBuV)	C.F (dB/m)	Measurement (dBuV/m)	Margin (dB)	Limit (dBuV/m)	Height (cm)	Angle (deg)	Remark (QP/PK/AV)
1	4880.000	39.83	-0.30	39.52	-34.48	74.00	150	360	Peak
2	7320.000	37.31	4.62	41.92	-32.08	74.00	150	360	Peak
3	* 9760.000	37.68	4.44	42.12	-31.88	74.00	150	360	Peak

Note:

1. " *" , means this data is the worst emission level.
2. C.F (Correction Factor) = Antenna Factor (dB)+ Cable Loss (dB) – Preamplifier(dB).
3. Measurement (dBuV/m) = Reading(dBuV) + C.F (Correction Factor).
4. The emission levels of other frequencies are very lower than the limit and not show in test report.

EUT	S2.2 TITANIUM	Date of Test	2021-12-10
Factor	DRH18-E & BBHA 9170	Temp. / Humidity	23°C /62%
Polarity	Vertical	Site / Test Engineer	AC2 / Volvo
Test Mode	BLE_TX_1Mbps_CH 19_TITANIUM	Test Voltage	By Notebook PC

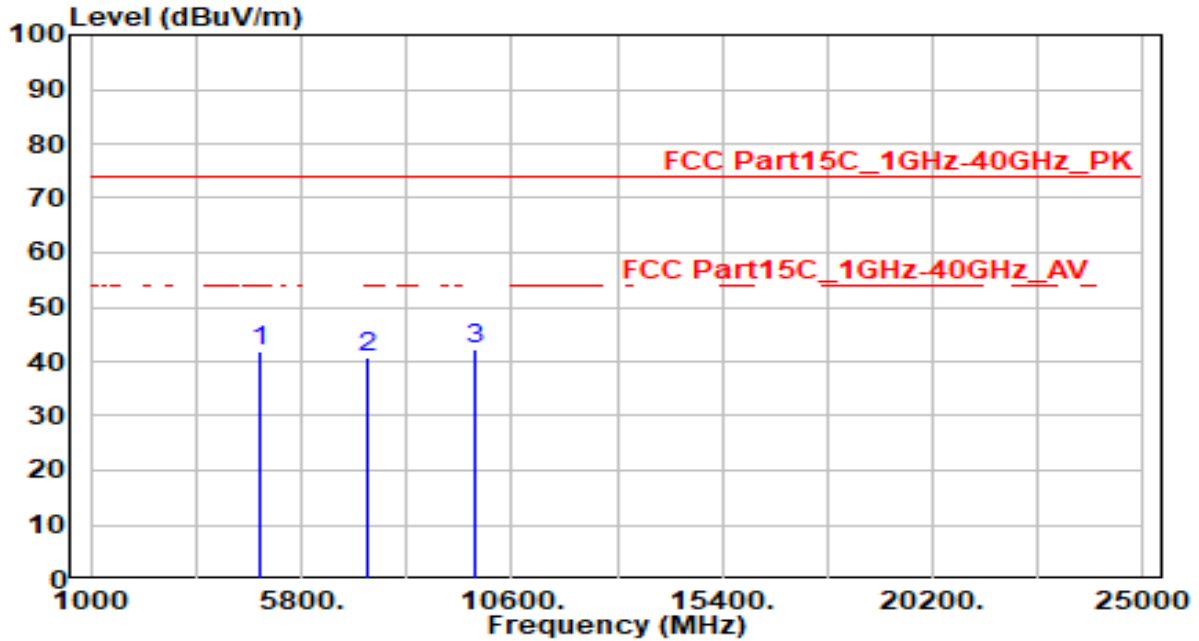

No	Frequency (MHz)	Reading (dBuV)	C.F (dB/m)	Measurement (dBuV/m)	Margin (dB)	Limit (dBuV/m)	Height (cm)	Angle (deg)	Remark (QP/PK/AV)
1	4880.000	42.29	-0.30	41.99	-32.01	74.00	150	360	Peak
2	7320.000	36.01	4.62	40.63	-33.37	74.00	150	360	Peak
3	* 9760.000	37.85	4.44	42.29	-31.71	74.00	150	360	Peak

Note:

1. " *" , means this data is the worst emission level.
2. C.F (Correction Factor) = Antenna Factor (dB)+ Cable Loss (dB) – Preamplifier(dB).
3. Measurement (dBuV/m) = Reading(dBuV) + C.F (Correction Factor).
4. The emission levels of other frequencies are very lower than the limit and not show in test report.

EUT	S2.2 TITANIUM	Date of Test	2021-12-10
Factor	DRH18-E & BBHA 9170	Temp. / Humidity	23°C /62%
Polarity	Horizontal	Site / Test Engineer	AC2 / Volvo
Test Mode	BLE_TX_1Mbps_CH 39_TITANIUM	Test Voltage	By Notebook PC

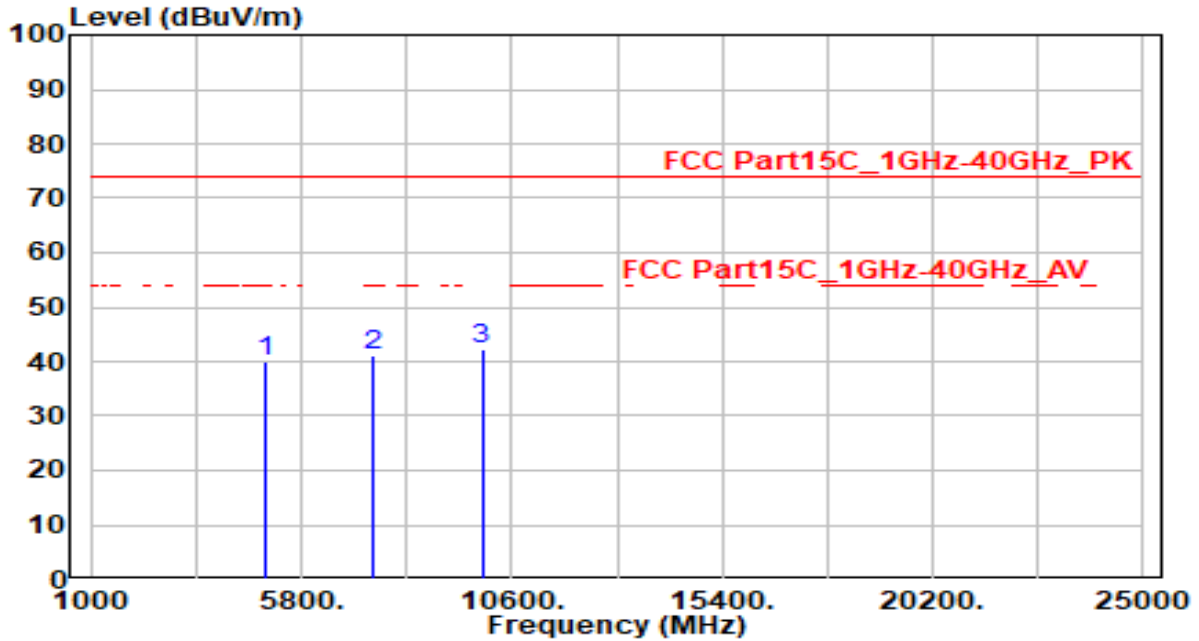

No	Frequency (MHz)	Reading (dBuV)	C.F (dB/m)	Measurement (dBuV/m)	Margin (dB)	Limit (dBuV/m)	Height (cm)	Angle (deg)	Remark (QP/PK/AV)
1	4960.000	40.15	-0.15	40.01	-33.99	74.00	150	360	Peak
2	7440.000	36.46	4.65	41.11	-32.89	74.00	150	360	Peak
3	* 9920.000	37.71	4.47	42.18	-31.82	74.00	150	360	Peak

Note:

1. " *", means this data is the worst emission level.
2. C.F (Correction Factor) = Antenna Factor (dB)+ Cable Loss (dB) – Preamplifier(dB).
3. Measurement (dBuV/m) = Reading(dBuV) + C.F (Correction Factor).
4. The emission levels of other frequencies are very lower than the limit and not show in test report.

EUT	S2.2 TITANIUM	Date of Test	2021-12-10
Factor	DRH18-E & BBHA 9170	Temp. / Humidity	23°C /62%
Polarity	Vertical	Site / Test Engineer	AC2 / Volvo
Test Mode	BLE_TX_1Mbps_CH 39_TITANIUM	Test Voltage	By Notebook PC

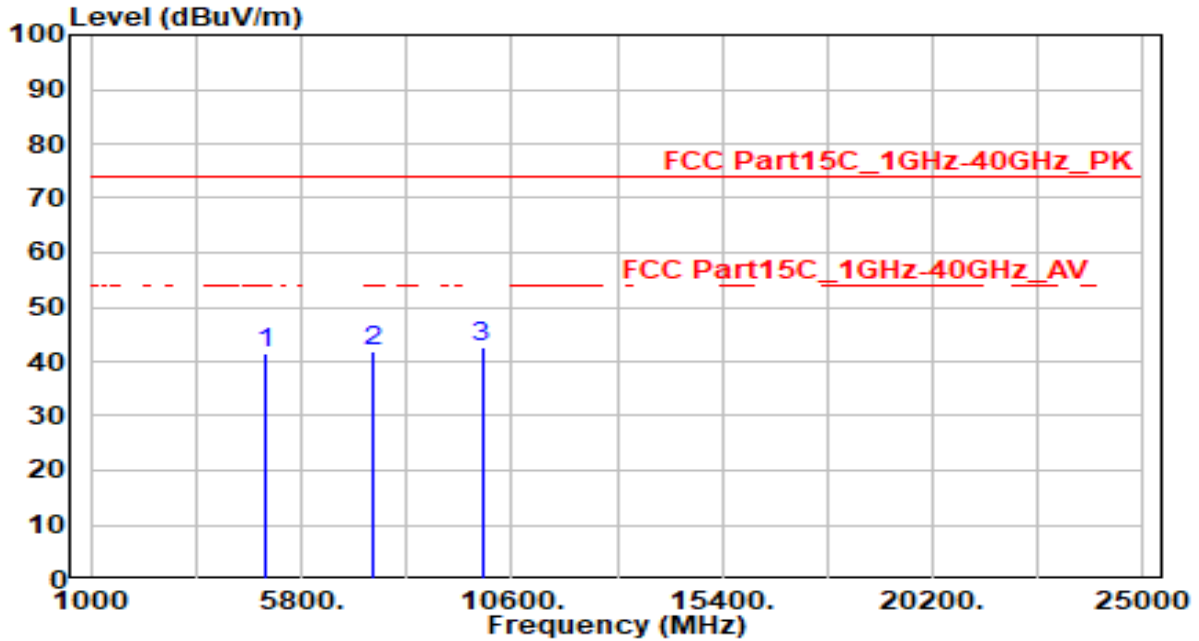

No	Frequency (MHz)	Reading (dBuV)	C.F (dB/m)	Measurement (dBuV/m)	Margin (dB)	Limit (dBuV/m)	Height (cm)	Angle (deg)	Remark (QP/PK/AV)
1	4959.406	41.68	-0.15	41.53	-32.47	74.00	150	360	Peak
2	7440.000	37.20	4.65	41.85	-32.15	74.00	150	360	Peak
3	* 9920.000	38.15	4.47	42.62	-31.38	74.00	150	360	Peak

Note:

1. " *" , means this data is the worst emission level.
2. C.F (Correction Factor) = Antenna Factor (dB)+ Cable Loss (dB) – Preamplifier(dB).
3. Measurement (dBuV/m) = Reading(dBuV) + C.F (Correction Factor).
4. The emission levels of other frequencies are very lower than the limit and not show in test report.

EUT	S2.2 TITANIUM	Date of Test	2021-12-10
Factor	DRH18-E & BBHA 9170	Temp. / Humidity	23°C /62%
Polarity	Horizontal	Site / Test Engineer	AC2 / Volvo
Test Mode	BLE_RX_1Mbps_CH 19_TITANIUM	Test Voltage	By Notebook PC

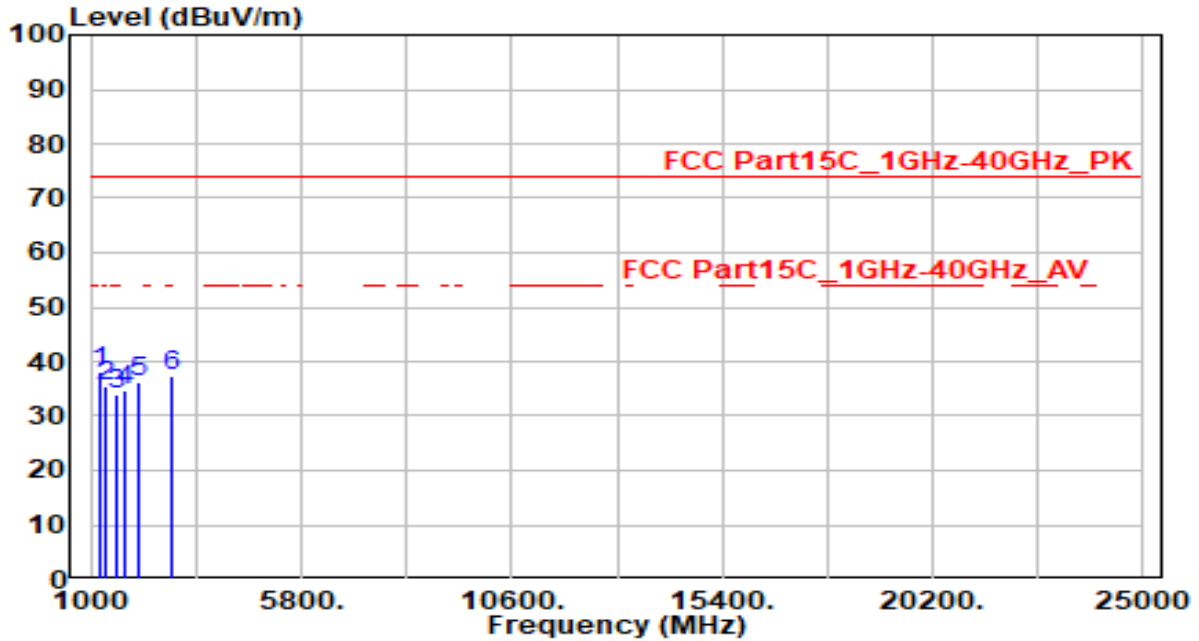

No	Frequency (MHz)	Reading (dBuV)	C.F (dB/m)	Measurement (dBuV/m)	Margin (dB)	Limit (dBuV/m)	Height (cm)	Angle (deg)	Remark (QP/PK/AV)
1	* 1197.094	46.21	-8.16	38.05	-35.95	74.00	150	360	Peak
2	1320.344	43.57	-8.10	35.47	-38.53	74.00	150	360	Peak
3	1593.938	42.00	-7.89	34.12	-39.88	74.00	150	360	Peak
4	1801.656	42.28	-7.61	34.66	-39.34	74.00	150	360	Peak
5	2101.281	42.20	-6.14	36.05	-37.95	74.00	150	360	Peak
6	2840.250	41.90	-4.46	37.43	-36.57	74.00	150	360	Peak

Note:

1. " *", means this data is the worst emission level.
2. C.F (Correction Factor) = Antenna Factor (dB)+ Cable Loss (dB) – Preamplifier(dB).
3. Measurement (dBuV/m) = Reading(dBuV) + C.F (Correction Factor).
4. The emission levels of other frequencies are very lower than the limit and not show in test report.

EUT	S2.2 TITANIUM	Date of Test	2021-12-10
Factor	DRH18-E & BBHA 9170	Temp. / Humidity	23°C /62%
Polarity	Vertical	Site / Test Engineer	AC2 / Volvo
Test Mode	BLE_RX_1Mbps_CH 19_TITANIUM	Test Voltage	By Notebook PC

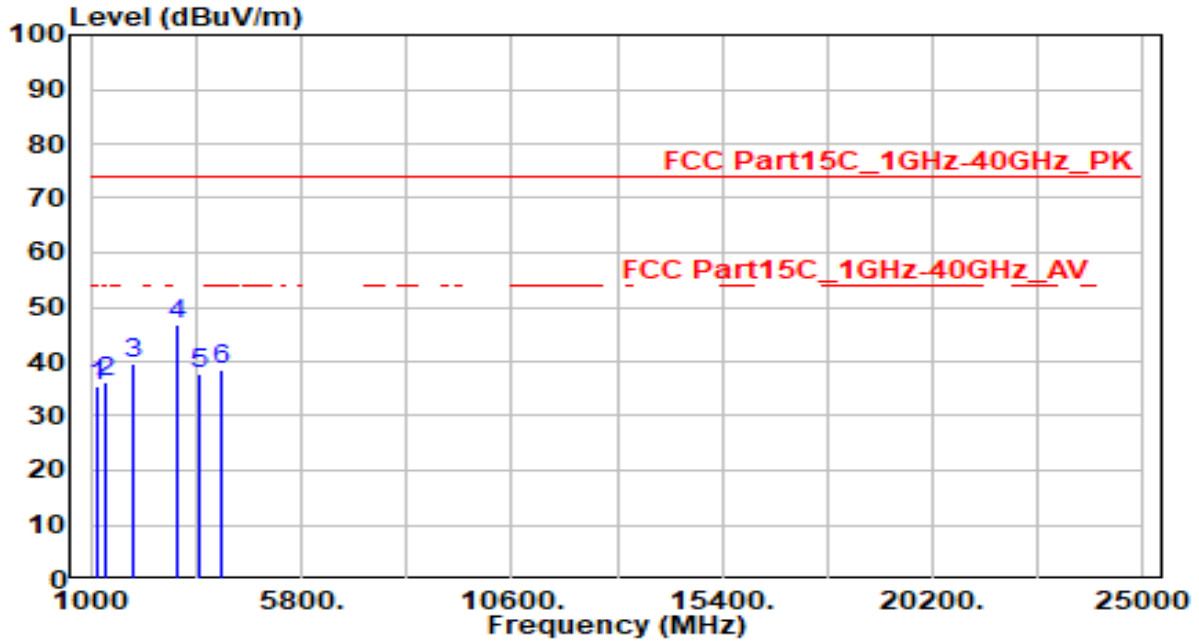

No	Frequency (MHz)	Reading (dBuV)	C.F (dB/m)	Measurement (dBuV/m)	Margin (dB)	Limit (dBuV/m)	Height (cm)	Angle (deg)	Remark (QP/PK/AV)
1	1179.031	43.57	-8.25	35.32	-38.68	74.00	150	360	Peak
2	1364.438	44.14	-8.09	36.05	-37.95	74.00	150	360	Peak
3	1993.438	45.89	-6.41	39.48	-34.52	74.00	150	360	Peak
4	* 2991.656	50.78	-4.17	46.61	-27.39	74.00	150	360	Peak
5	3503.781	41.26	-3.42	37.84	-36.16	74.00	150	360	Peak
6	3966.500	40.45	-1.94	38.52	-35.48	74.00	150	360	Peak

Note:

- "*", means this data is the worst emission level.
- C.F (Correction Factor) = Antenna Factor (dB)+ Cable Loss (dB) – Preamplifier(dB).
- Measurement (dBuV/m) = Reading(dBuV) + C.F (Correction Factor).
- The emission levels of other frequencies are very lower than the limit and not show in test report.

7.7. Radiated Restricted Band Edge Measurement

7.7.1. Test Limit

All out of band emissions appearing in a restricted band as specified in Section 15.205/ IC RSS-Gen must not exceed the limits shown in Table per Section 15.209/ IC RSS-Gen Table 5, 6.

FCC Part 15 Subpart C Paragraph 15.209/ IC RSS-Gen Table 5, 6		
Frequency [MHz]	Field Strength [V/m]	Measured Distance [Meters]
0.009 - 0.490	2400/F (kHz)	300
0.490 - 1.705	24000/F (kHz)	30
1.705 – 30	30	30
30 – 88	100	3
88 – 216	150	3
216 – 960	200	3
Above 960	500	3

7.7.2. Test Procedure Used

ANSI C63.10-2013 - Section 11.13

7.7.3. Test Setting

Peak Field Strength Measurements

1. Analyzer center frequency was set to the frequency of the radiated spurious emission of interest
2. RBW = as specified in Table 1
3. VBW = 3 * RBW
4. Detector = peak
5. Sweep time = auto couple
6. Trace mode = max hold
7. Trace was allowed to stabilize

Table 1 - RBW as a function of frequency

Frequency	RBW
9 ~ 150 kHz	200 ~ 300 Hz
0.15 ~ 30 MHz	9 ~ 10 kHz
30 ~ 1000 MHz	100 ~ 120 kHz
> 1000 MHz	1 MHz

Average Field Strength Measurements

1. Analyzer center frequency was set to the frequency of the radiated spurious emission of interest
2. RBW = 1MHz
3. VBW $\geq 1/T$
4. De As an alternative, the instrument may be set to linear detector mode. Ensure that video filtering is applied in linear voltage domain (rather than in a log or dB domain). Some instruments require linear display mode in order to accomplish this. Others have a setting for Average-VBW Type, which can be set to "Voltage" regardless of the display mode
5. Detector = Peak
6. Sweep time = auto
7. Trace mode = max hold
8. Allow max hold to run for at least 50 times (1/duty cycle) traces

7.7.4. Test Setup

1GHz ~ 18GHz Test Setup:

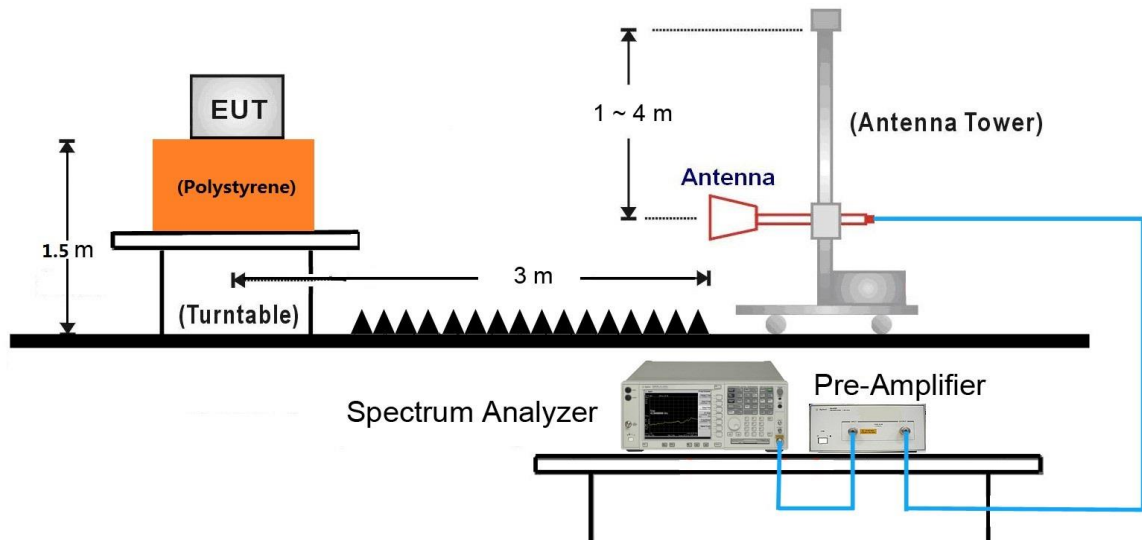

7.7.5. Test Result

EUT	S2.2 TITANIUM	Date of Test	2021-12-10
Factor	DRH18-E	Temp. / Humidity	23°C /62%
Polarity	Horizontal	Site / Test Engineer	AC2 / Volvo
Test Mode	BLE_TX_1Mbps_CH 0_TITANIUM	Test Voltage	By Notebook PC

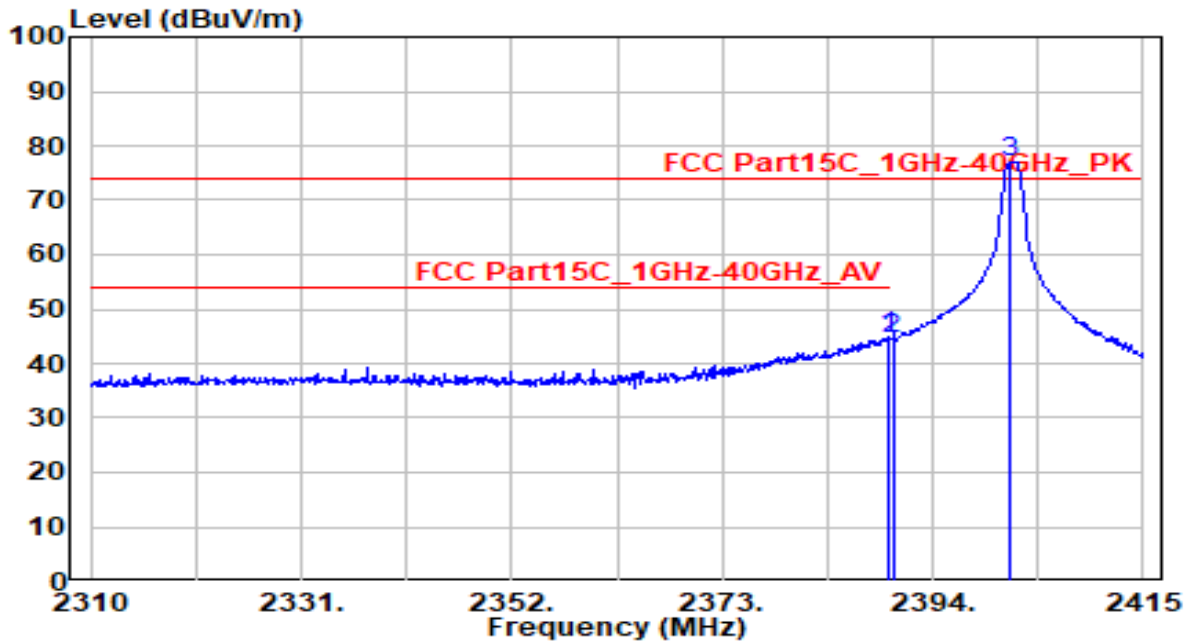

No	Frequency (MHz)	Reading (dBuV)	C.F (dB/m)	Measurement (dBuV/m)	Margin (dB)	Limit (dBuV/m)	Height (cm)	Angle (deg)	Remark (QP/PK/AV)
1	* 2389.485	50.66	-5.65	45.00	-29.00	74.00	240	220	Peak
2	2390.010	50.12	-5.65	44.46	-29.54	74.00	240	220	Peak
3	2401.770	82.69	-5.64	77.05	N/A	N/A	240	220	Peak

Note:

1. " *", means this data is the worst emission level.
2. C.F (Correction Factor) = Antenna Factor (dB)+ Cable Loss (dB) – Preamplifier(dB).
3. Measurement (dBuV/m) = Reading(dBuV) + C.F (Correction Factor).
4. The emission levels of other frequencies are very lower than the limit and not show in test report.

EUT	S2.2 TITANIUM	Date of Test	2021-12-10
Factor	DRH18-E	Temp. / Humidity	23°C /62%
Polarity	Vertical	Site / Test Engineer	AC2 / Volvo
Test Mode	BLE_TX_1Mbps_CH 0_TITANIUM	Test Voltage	By Notebook PC

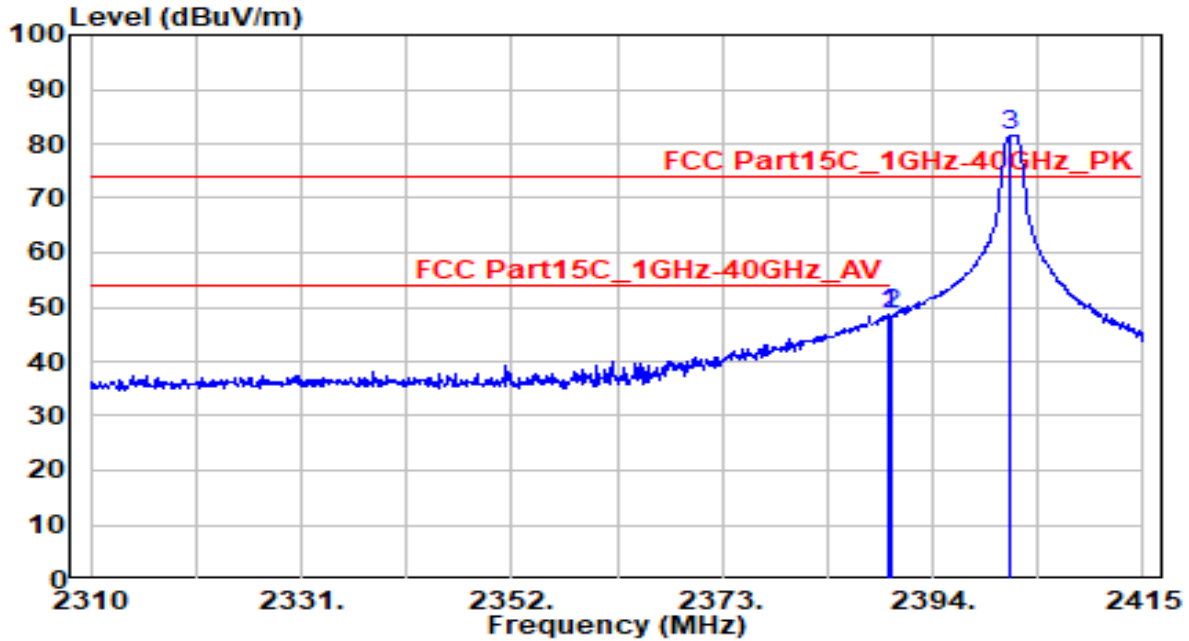

No	Frequency (MHz)	Reading (dBuV)	C.F (dB/m)	Measurement (dBuV/m)	Margin (dB)	Limit (dBuV/m)	Height (cm)	Angle (deg)	Remark (QP/PK/AV)
1	2389.590	54.26	-5.65	48.60	-25.40	74.00	120	105	Peak
2	* 2390.000	54.32	-5.65	48.66	-25.34	74.00	120	105	Peak
3	2401.770	87.24	-5.64	81.60	N/A	N/A	120	105	Peak

Note:

1. " *", means this data is the worst emission level.
2. C.F (Correction Factor) = Antenna Factor (dB)+ Cable Loss (dB) – Preamplifier(dB).
3. Measurement (dBuV/m) = Reading(dBuV) + C.F (Correction Factor).
4. The emission levels of other frequencies are very lower than the limit and not show in test report.

EUT	S2.2 TITANIUM	Date of Test	2021-12-10
Factor	DRH18-E	Temp. / Humidity	23°C /62%
Polarity	Horizontal	Site / Test Engineer	AC2 / Volvo
Test Mode	BLE_TX_1Mbps_CH 39_TITANIUM	Test Voltage	By Notebook PC

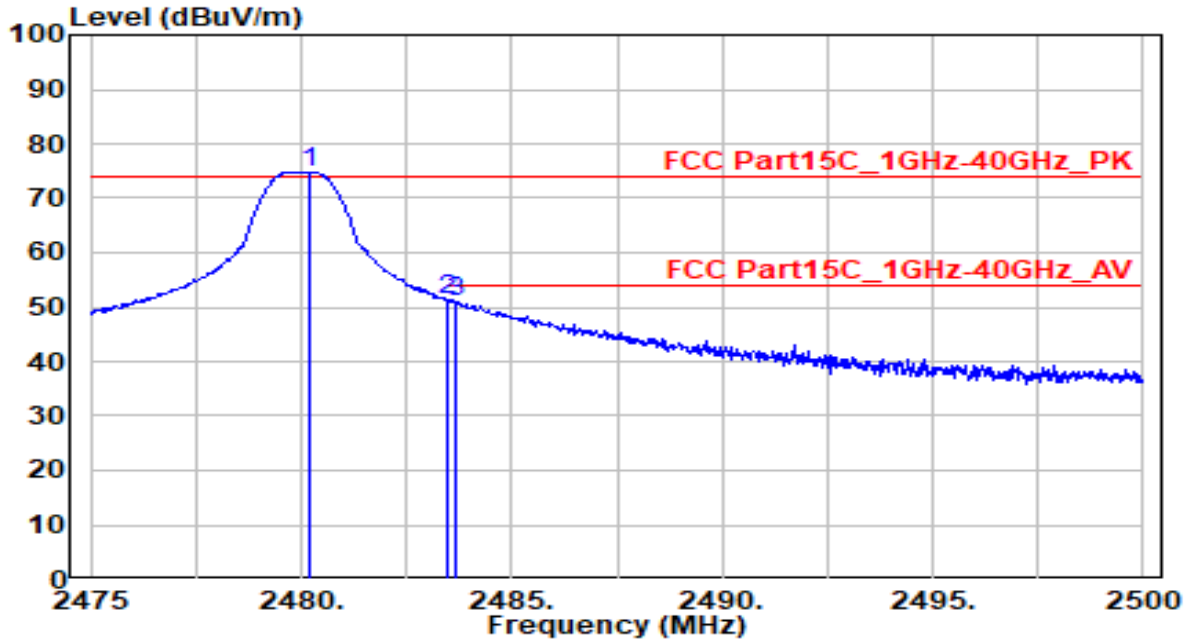

No	Frequency (MHz)	Reading (dBuV)	C.F (dB/m)	Measurement (dBuV/m)	Margin (dB)	Limit (dBuV/m)	Height (cm)	Angle (deg)	Remark (QP/PK/AV)
1	2480.225	80.37	-5.55	74.82	N/A	N/A	220	210	Peak
2	* 2483.500	56.74	-5.55	51.19	-22.81	74.00	220	210	Peak
3	2483.675	56.54	-5.55	50.99	-23.01	74.00	220	210	Peak

Note:

1. " *", means this data is the worst emission level.
2. C.F (Correction Factor) = Antenna Factor (dB)+ Cable Loss (dB) – Preamplifier(dB).
3. Measurement (dBuV/m) = Reading(dBuV) + C.F (Correction Factor).
4. The emission levels of other frequencies are very lower than the limit and not show in test report.

EUT	S2.2 TITANIUM	Date of Test	2021-12-10
Factor	DRH18-E	Temp. / Humidity	23°C /62%
Polarity	Vertical	Site / Test Engineer	AC2 / Volvo
Test Mode	BLE_TX_1Mbps_CH 39_TITANIUM	Test Voltage	By Notebook PC

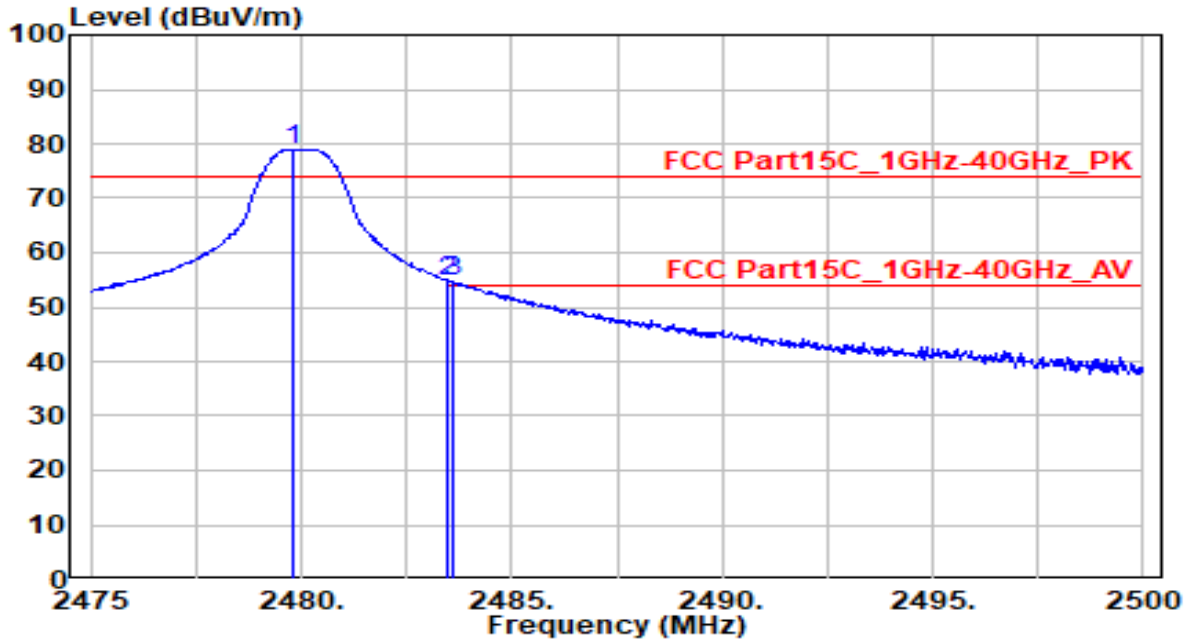

No	Frequency (MHz)	Reading (dBuV)	C.F (dB/m)	Measurement (dBuV/m)	Margin (dB)	Limit (dBuV/m)	Height (cm)	Angle (deg)	Remark (QP/PK/AV)
1	2479.775	84.48	-5.55	78.93	N/A	N/A	165	130	Peak
2	* 2483.500	60.43	-5.55	54.88	-19.12	74.00	165	130	Peak
3	2483.625	60.34	-5.55	54.79	-19.21	74.00	165	130	Peak

Note:

1. " *", means this data is the worst emission level.
2. C.F (Correction Factor) = Antenna Factor (dB)+ Cable Loss (dB) – Preamplifier(dB).
3. Measurement (dBuV/m) = Reading(dBuV) + C.F (Correction Factor).
4. The emission levels of other frequencies are very lower than the limit and not show in test report.

EUT	S2.2 TITANIUM	Date of Test	2021-12-10
Factor	DRH18-E	Temp. / Humidity	23°C /62%
Polarity	Vertical	Site / Test Engineer	AC2 / Volvo
Test Mode	BLE_TX_1Mbps_CH 39_TITANIUM	Test Voltage	By Notebook PC

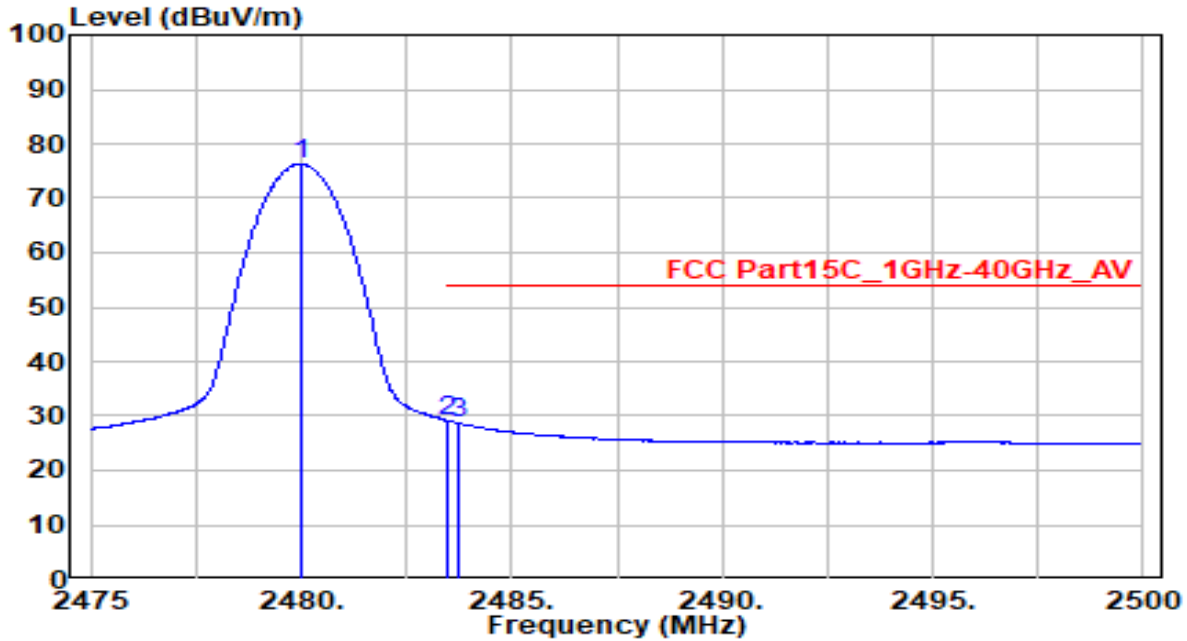

No	Frequency (MHz)	Reading (dBuV)	C.F (dB/m)	Measurement (dBuV/m)	Margin (dB)	Limit (dBuV/m)	Height (cm)	Angle (deg)	Remark (QP/PK/AV)
1	2479.975	81.83	-5.55	76.27	N/A	N/A	165	130	Average
2	* 2483.500	34.61	-5.55	29.06	-24.94	54.00	165	130	Average
3	2483.750	34.19	-5.55	28.64	-25.36	54.00	165	130	Average

Note:

1. " *", means this data is the worst emission level.
2. C.F (Correction Factor) = Antenna Factor (dB)+ Cable Loss (dB) – Preamplifier(dB).
3. Measurement (dBuV/m) = Reading(dBuV) + C.F (Correction Factor).
4. The emission levels of other frequencies are very lower than the limit and not show in test report.

7.8. AC Conducted Emissions Measurement

7.8.1. Test Limit

FCC Part 15 Subpart C Paragraph 15.207 / RSS-Gen Limits		
Frequency (MHz)	QP (dB μ V)	Average (dB μ V)
0.15 - 0.50	66 - 56	56 - 46
0.50 - 5.0	56	46
5.0 - 30	60	50

Note 1: The lower limit shall apply at the transition frequencies.

Note 2: The limit decreases linearly with the logarithm of the frequency in the range 0.15MHz to 0.5MHz.

7.8.2. Test Setup

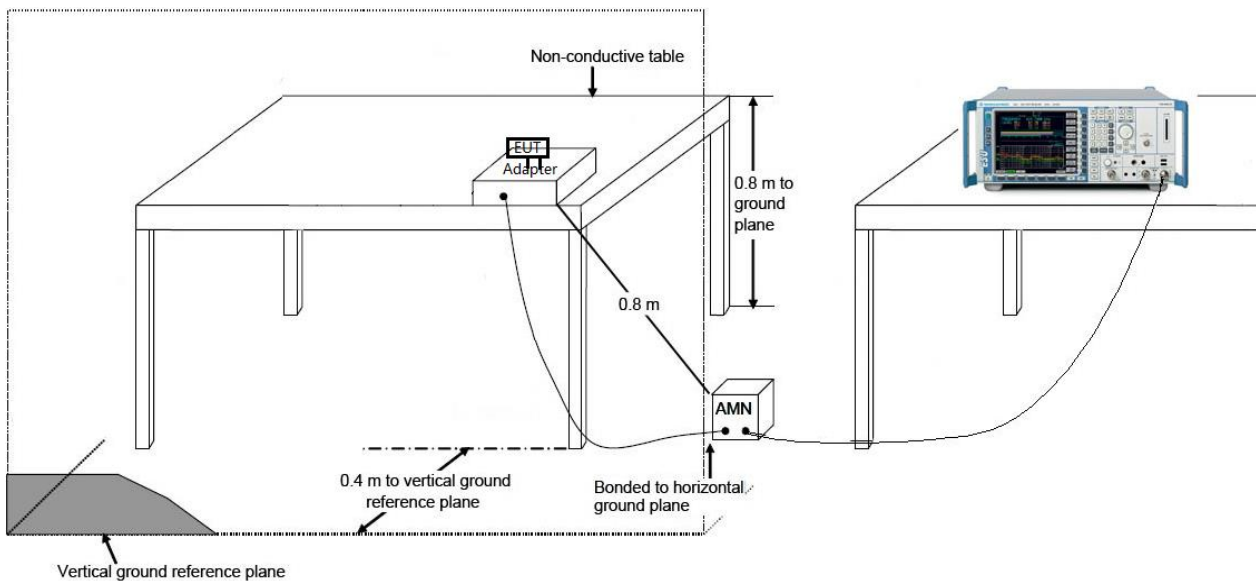

7.8.3. Test Result

EUT	S2.2 TITANIUM	Date of Test	2021-12-10
Factor	CE_ENV216-L1 (Filter ON)	Temp. / Humidity	23.5°C /50%
Polarity	Line1	Site / Test Engineer	SR2 / Volvo
Test Mode	BLE_TX_1Mbps_CH 19	Test Voltage	AC 120V/60Hz

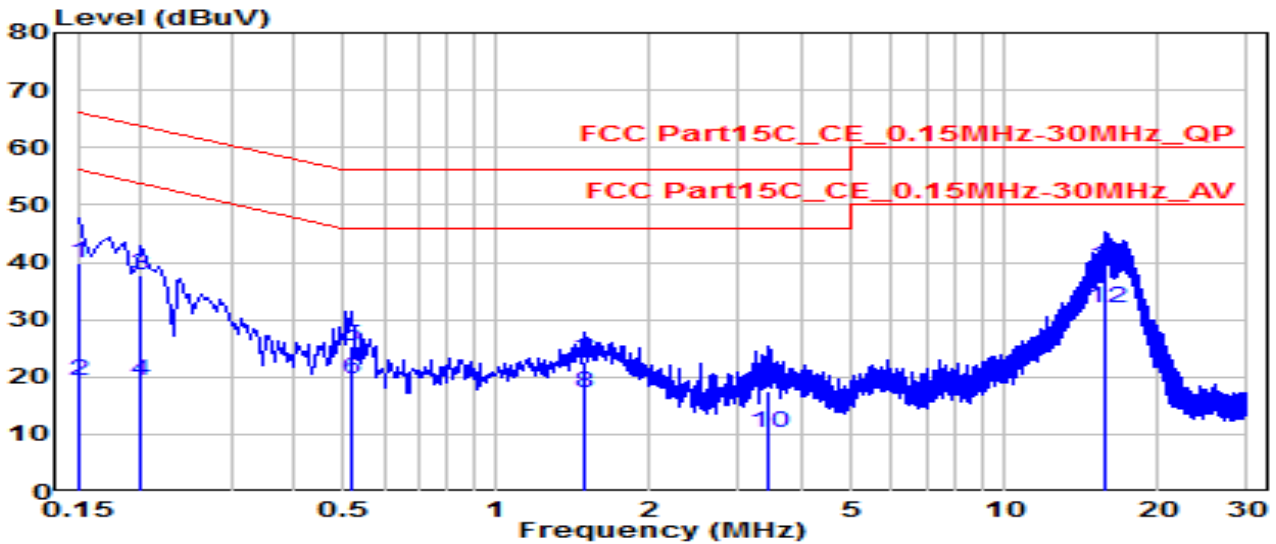

No	Frequency (MHz)	Reading (dBuV)	C.F (dB)	Measurement (dBuV/m)	Margin (dB)	Limit (dBuV/m)	Remark (QP/PK/AV)
1	0.150	30.25	9.61	39.86	-26.14	66.00	QP
2	0.150	9.85	9.61	19.46	-36.54	56.00	Average
3	0.199	28.23	9.61	37.85	-25.79	63.63	QP
4	0.199	9.81	9.61	19.42	-34.21	53.63	Average
5	0.519	15.70	9.63	25.33	-30.67	56.00	QP
6	0.519	10.03	9.63	19.66	-26.34	46.00	Average
7	1.495	12.90	9.67	22.58	-33.42	56.00	QP
8	1.495	7.58	9.67	17.25	-28.75	46.00	Average
9	3.408	7.71	9.71	17.42	-38.58	56.00	QP
10	3.408	0.52	9.71	10.23	-35.77	46.00	Average
11	* 15.849	29.32	9.93	39.25	-20.75	60.00	QP
12	* 15.849	21.99	9.93	31.92	-18.08	50.00	Average

Note:

1. " *", means this data is the worst emission level.
2. C.F (Correction Factor) = Antenna Factor (dB)+ Cable Loss (dB).
3. Measurement (dBuV/m) = Reading(dBuV) + C.F (Correction Factor).

EUT	S2.2 TITANIUM	Date of Test	2021-12-10
Factor	CE_ENV216-N (Filter ON)	Temp. / Humidity	23.5°C /50%
Polarity	Neutral	Site / Test Engineer	SR2 / Volvo
Test Mode	BLE_TX_1Mbps_CH 19	Test Voltage	AC 120V/60Hz

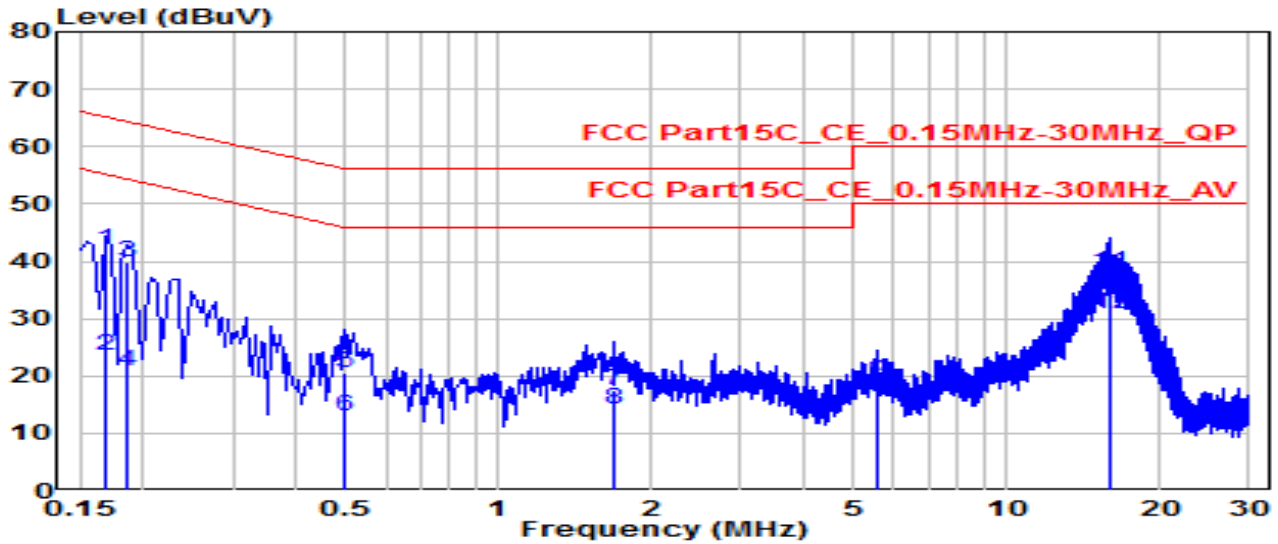

No	Frequency (MHz)	Reading (dBuV)	C.F (dB)	Measurement (dBuV/m)	Margin (dB)	Limit (dBuV/m)	Remark (QP/PK/AV)
1	0.168	32.49	9.62	42.11	-22.95	65.06	QP
2	0.168	13.79	9.62	23.41	-31.65	55.06	Average
3	0.186	30.22	9.61	39.83	-24.38	64.21	QP
4	0.186	11.23	9.61	20.84	-33.37	54.21	Average
5	0.496	10.84	9.63	20.47	-35.59	56.06	QP
6	0.496	3.42	9.63	13.05	-33.01	46.06	Average
7	1.698	7.79	9.68	17.48	-38.52	56.00	QP
8	1.698	4.37	9.68	14.05	-31.95	46.00	Average
9	5.531	9.23	9.76	18.99	-41.01	60.00	QP
10	5.531	6.17	9.76	15.94	-34.06	50.00	Average
11	*	15.898	9.98	37.97	-22.03	60.00	QP
12	*	15.898	9.98	30.88	-19.12	50.00	Average

Note:

1. " *", means this data is the worst emission level.
2. C.F (Correction Factor) = Antenna Factor (dB)+ Cable Loss (dB).
3. Measurement (dBuV/m) = Reading(dBuV) + C.F (Correction Factor).

EUT	S2.2 TITANIUM	Date of Test	2021-12-10
Factor	CE_ENV216-L1 (Filter ON)	Temp. / Humidity	23.5°C /50%
Polarity	Line1	Site / Test Engineer	SR2 / Volvo
Test Mode	BLE_TX_1Mbps_CH 19	Test Voltage	AC 240V/60Hz

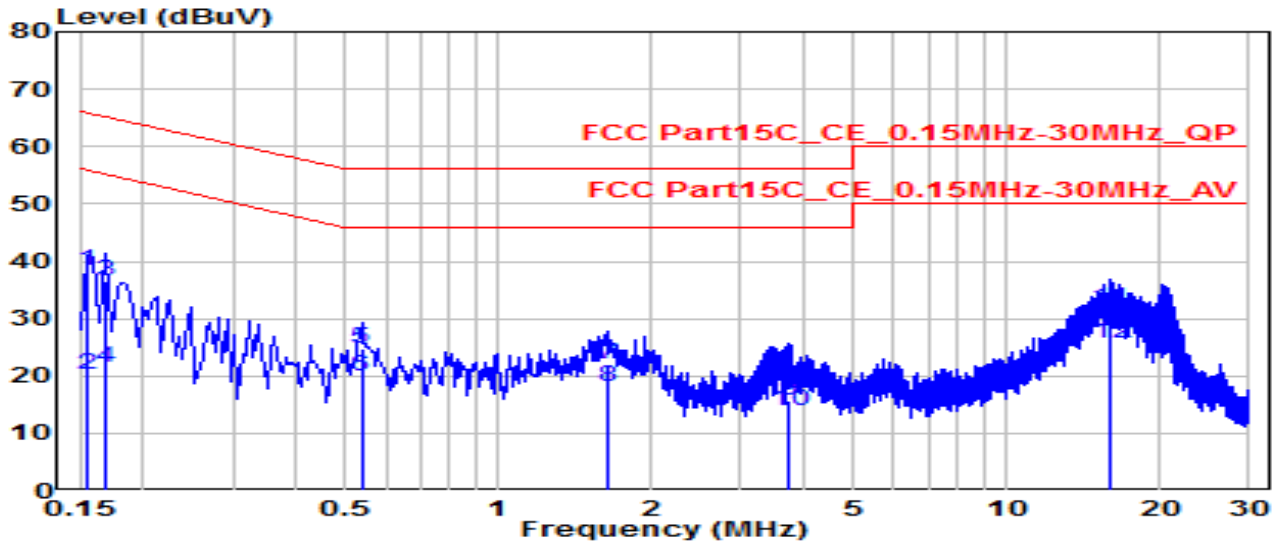

No	Frequency (MHz)	Reading (dBuV)	C.F (dB)	Measurement (dBuV/m)	Margin (dB)	Limit (dBuV/m)	Remark (QP/PK/AV)
1	0.154	28.67	9.61	38.28	-27.47	65.75	QP
2	0.154	10.55	9.61	20.16	-35.60	55.75	Average
3	0.168	27.06	9.61	36.67	-28.39	65.06	QP
4	0.168	11.71	9.61	21.32	-33.74	55.06	Average
5	0.537	15.25	9.63	24.89	-31.11	56.00	QP
6	0.537	10.37	9.63	20.00	-26.00	46.00	Average
7	1.644	12.25	9.68	21.93	-34.07	56.00	QP
8	1.644	8.43	9.68	18.11	-27.89	46.00	Average
9	3.718	6.04	9.72	15.76	-40.24	56.00	QP
10	3.718	4.31	9.72	14.02	-31.98	46.00	Average
11	* 15.925	21.91	9.93	31.84	-28.16	60.00	QP
12	* 15.925	15.69	9.93	25.62	-24.38	50.00	Average

Note:

1. " *", means this data is the worst emission level.
2. C.F (Correction Factor) = Antenna Factor (dB)+ Cable Loss (dB).
3. Measurement (dBuV/m) = Reading(dBuV) + C.F (Correction Factor).

EUT	S2.2 TITANIUM	Date of Test	2021-12-10
Factor	CE_ENV216-N (Filter ON)	Temp. / Humidity	23.5°C /50%
Polarity	Neutral	Site / Test Engineer	SR2 / Volvo
Test Mode	BLE_TX_1Mbps_CH 19	Test Voltage	AC 240V/60Hz

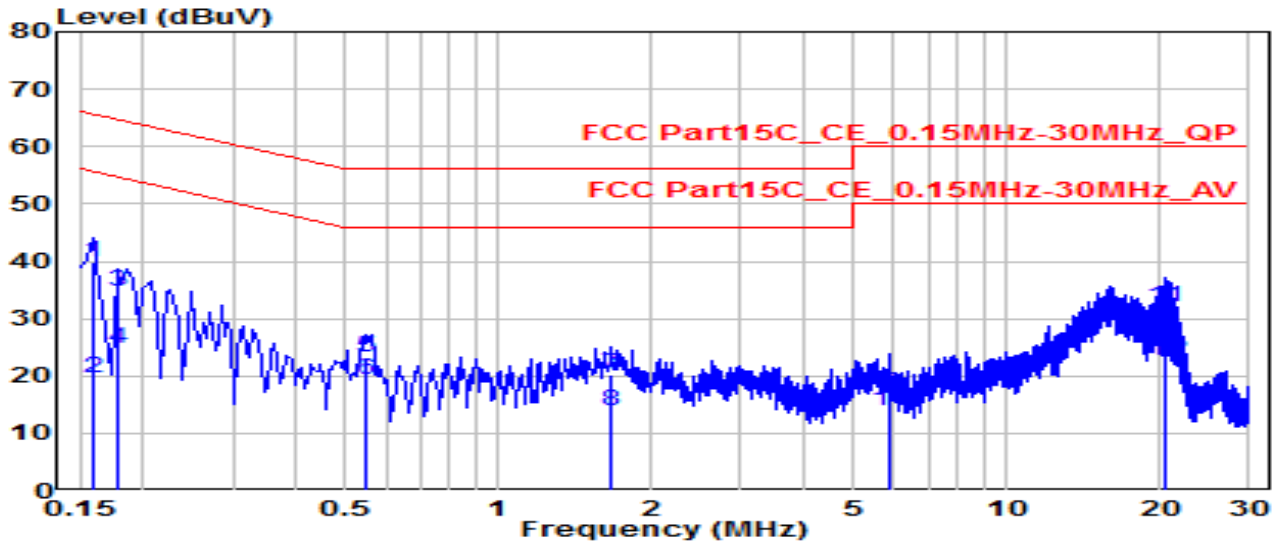

No		Frequency (MHz)	Reading (dBuV)	C.F (dB)	Measurement (dBuV/m)	Margin (dB)	Limit (dBuV/m)	Remark (QP/PK/AV)
1	*	0.159	30.13	9.62	39.75	-25.76	65.52	QP
2	*	0.159	9.92	9.62	19.54	-35.98	55.52	Average
3		0.177	25.10	9.62	34.72	-29.91	64.63	QP
4		0.177	15.14	9.62	24.76	-29.87	54.63	Average
5		0.546	13.63	9.64	23.26	-32.74	56.00	QP
6		0.546	9.77	9.64	19.41	-26.59	46.00	Average
7		1.662	10.51	9.68	20.19	-35.81	56.00	QP
8		1.662	4.25	9.68	13.93	-32.07	46.00	Average
9		5.873	7.23	9.77	17.01	-42.99	60.00	QP
10		5.873	3.99	9.77	13.76	-36.24	50.00	Average
11		20.501	21.94	10.06	31.99	-28.01	60.00	QP
12		20.501	12.57	10.06	22.62	-27.38	50.00	Average

Note:

1. " *", means this data is the worst emission level.
2. C.F (Correction Factor) = Antenna Factor (dB)+ Cable Loss (dB).
3. Measurement (dBuV/m) = Reading(dBuV) + C.F (Correction Factor).

8. CONCLUSION

The data collected relate only the item(s) tested and show that the **SEQUENT ELEKTRON WATCH**, **SEQUENT SUPERCHARGER WATCH**, is in compliance with Part 15C & IC RSS-247 of the FCC Rules & IC Rules.

————— The End —————