

MCU: AD6983B

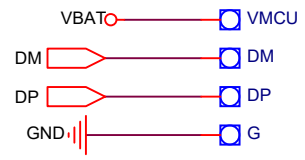
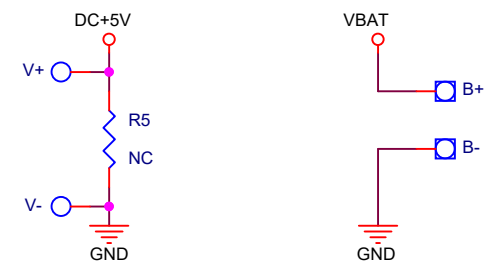
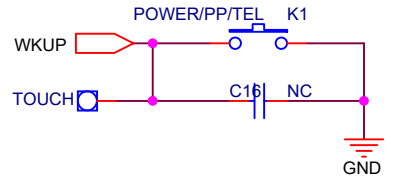
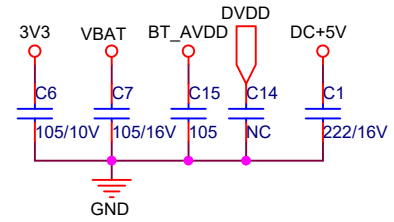
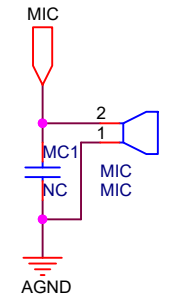
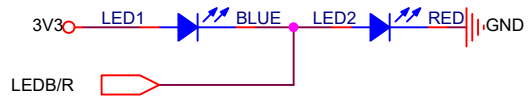
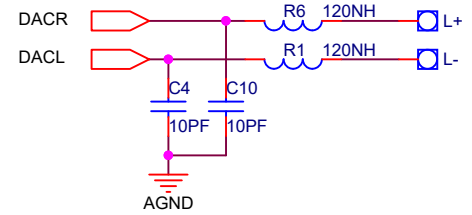
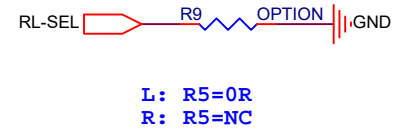
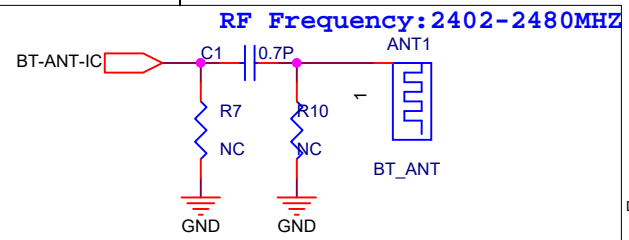
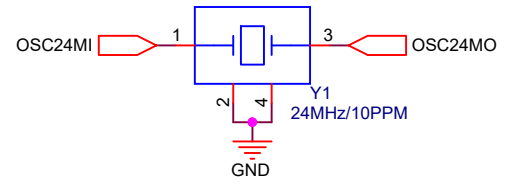
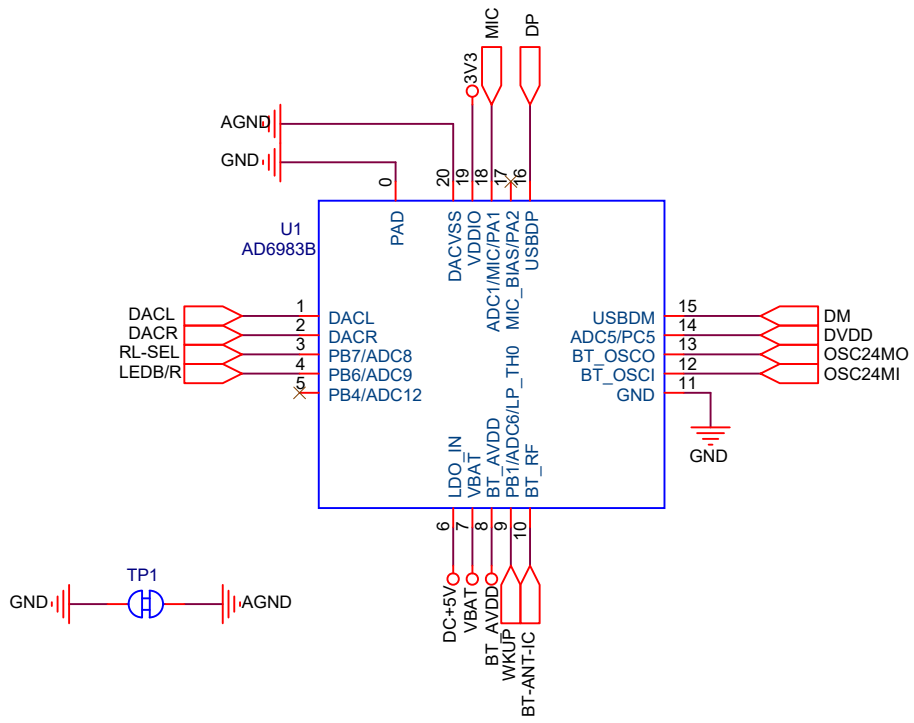

Title		<Title>
Size	Document Number	Rev
A4	<Doc>	V2
Date:	Monday, January 17, 2022	Sheet 1 of 1