

Installation of the Trailing Bar and Mop

! The trailing bar and mop **MUST** be installed before the tank is installed.

- Robot initially comes with trailing bar and mop installed.

1. Turn off the power to the robot by flipping the power switch or clicking the  button located on the top left of the remote.

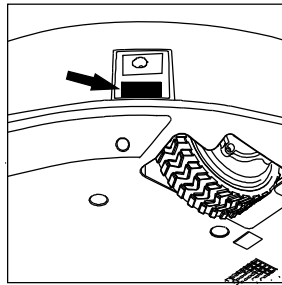

2. Gently pick up the robot and lay it with its wheels facing up.

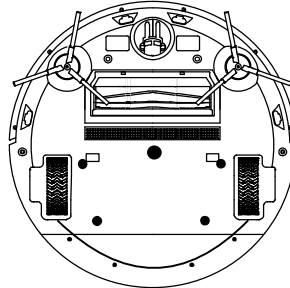

3. Flip the trailing bar so the adhesive side faces the mop pad and slide the front two prongs into the sleeve on the back side of the mop pad. Align the hole on the trailing bar to the hole on the sleeve of the mop pad. Firmly press down on the mop pad to secure the mop pad to the adhesives on the trailing bar,

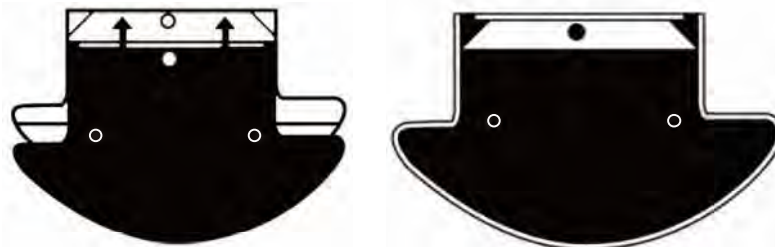

4. Flip the mop pad and trailing bar so that the mop pad is facing up. Insert the front two prongs of the trailing bar into the two matching holes adjacent to the back wheels on the robot. The curved edge of the trailing bar will match with the curved edge of the robot.
5. Insert the two prongs on the underside of the trailing bar into the matching holes located near the end of the wheels of the robot. Push down on the trailing bar and mop pad until they are lying flat and secure on the robot.

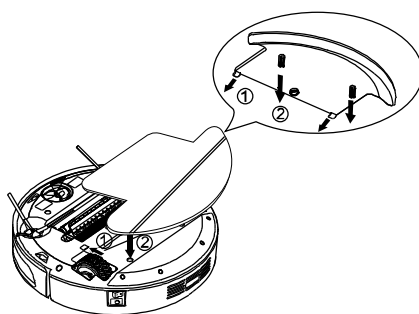

Installation of the Tank

! The trailing bar and mop **MUST** be installed before the tank is installed.

1. Press the "PUSH" label on the top cover of the robot for the cover to open and expose its containments.

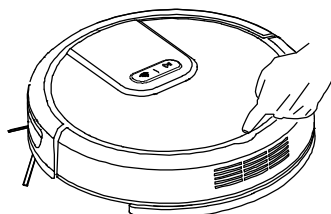

2. Remove the large dust bin if necessary. Lift the handle to remove the whole container up and out of the robot.

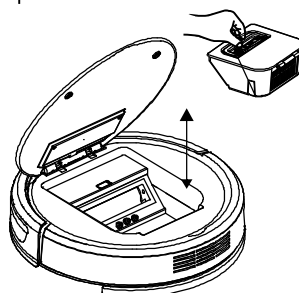

3. Connect the small dust bin to the tank by sliding the prongs on the left and right side of the small dust bin into the slots on each side of the tank.

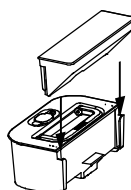

4. Fill the tank with water or any desired cleaning solution by removing the orange plastic stopper with a nozzle symbol located on the top of the tank and filling until full. Reinsert the plastic stopper.

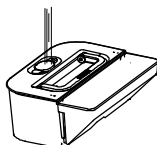

! Dry off the tank and small dust bin before inserting into the robot.

- Certain cleaning solutions may need to be diluted with water before inserting into the tank.
- Certain cleaning solutions may stain the mop pad.

5. Place the tank and small dust bin combination into the robot by lifting the handle on the tank and inserting the combination with the tank closest to the exhaust filter on the robot.

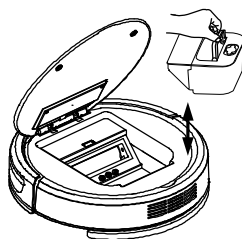

! Do not allow the combination to sway or be turned upside down as solution will leak from the tank.

6. Lower the panel cover until it returns to its preexisting position and a click is heard.

Setting the Intelligent Tank

1. Press the "⊙" button, the instruction light on the cleaner is normally on, the icon "⊙" on the remote controller is also normally on, indicating the water tank is in a standard water seeping mode, suitable for wooden floor, as too much water will ruin the wooden floor. This mode is also suitable for clean floor.
2. Press and hold the "⊙" button for 4 seconds, the instruction light on the cleaner is blinking, the icon "⊙" on the remote controller will flash; indicating the water tank is in a quick water seeping mode, suitable for tile/marble floor or dirty floor.



- ⚠ Do not charge the robot while the tank is installed and filled with solution.
- ⚠ Do not start a cleaning session without the large dust bin or the small dust bin and tank combination inside of the robot.
- ⚠ Do not flip robot upside down when the large dust bin or the small dust bin and tank are installed and full.



Advanced Cleaning

For a deeper and more precise clean, incorporate an advanced cleaning feature to the dry or wet cleaning session.

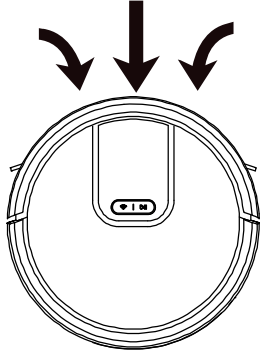

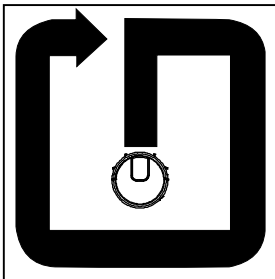

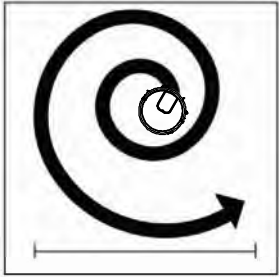
! Be sure to move any obstacles including rugs, blinds, or cords that may be in the way.

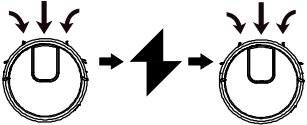
Before selecting an advanced cleaning method, put robot standby mode by pressing the  button.

Cleaning Method	Function	How to Select	Diagram
Turbo	<p>Robot will increase suction. Suitable for a very dirty floor or a thick carpet.</p> <p>! Turbo mode cannot be accessed while using the mop cleaning method.</p>	Press the  button on the remote.	
Wall Following	Robot will move to the wall and will clean the floor by following the perimeter of the room.	Press the  button on the remote.	

<p>Spot</p>	<p>Robot will begin cleaning in a spiral pattern leading to a one-meter diameter circle for two to three minutes.</p> <p>-Recommended for deep cleaning in smaller areas covered in debris.</p>	<p>Press the  button on the remote.</p>	 <p>1 M</p>
<p>Full Go</p>	<p>Robot will go into auto cleaning mode until the battery is too low, return to the charging dock until the battery is fully charged and then clean one more time until the battery is too low again.</p> <p>-Recommended for very dirty flooring or carpet.</p>	<p>Press the  button on the remote.</p>	

Finishing a Cleaning Session

- Robot will automatically end the cleaning session when the battery is too low. Five beeps will sound and robot will begin to maneuver back to the charging dock.
 - For a user prompted end of cleaning, press the  button on the panel or the  button on the remote to stop the cleaning. To stop the cleaning session and return to the charging dock to automatically recharge, press the  button on the remote and robot will begin to find the charging dock.
 - The user may direct the robot near the charging dock by using the arrows on the remote if it is taking a long period of time to return home.
 - The user may pick up and place the robot on the charging dock if it has run out of battery before locating the charging dock .
-  **The robot might have difficulty finding the charging dock in a larger room or a room full of obstacles.**

Time and Date Settings

1. Programming the Time and Date

a. Settings of current week day:

In the standby mode, press the "⏸" button to enter the setting of current week day;
press the "⏪" "⏩" buttons to switch Monday/Sunday;
press the "⏹" to save the current week day and enter the setting of current hour/minute.

b. Settings of current hour/minute:

After the settings of current week day is done, then enter the specific settings of current hour/minute.
press the "⏪" "⏩" buttons to switch hour/minute.
press the "⏴" buttons to increment the current time, and press the "⏵" button vice versa;
press the "⏹" buttons to save the current hour/minute.

2. Scheduling a Routine Cleaning

a. Settings of Schedule week day:

In the standby mode, press the "⏸" button on the remote controller 4 seconds to enter the settings of schedule week day;
press the "⏪" "⏩" buttons to switch Monday/Sunday;
press the "⏹" to save the appointed week day and enter the setting of appointed hour/minute.

b. Settings of Schedule hour/minute:

After the settings of schedule week day is done, press the "⏴" button on the remote controller to save, press the "⏵" button on the remote controller to cancel, then press the "⏹" button on the remote controller to save, enter the settings of appointed hour/minute.
Press the "⏪" and "⏩" buttons to switch hours/minute;
Press the "⏴" buttons to increment the appointed time, and press the "⏵" button vice versa;
Press the "⏹" buttons to save the setting of appointed hour/minute.

Maintenance

Removal of the Side Brushes

1. Turn off the power to the robot by flipping the power switch or clicking the  button on the remote.

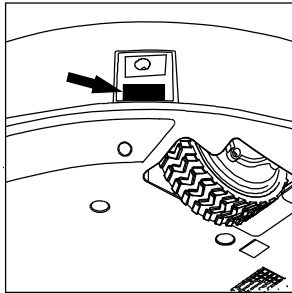

2. Gently pick up the robot and lay it with its wheels facing up.

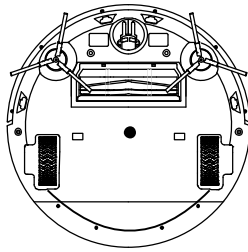

3. Firmly grasp one of the plastic spokes containing the wire brushes and pull straight up.

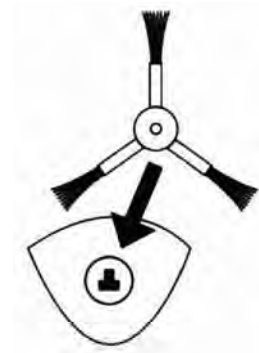

-The side brushes should only be replaced if the previous side brushes become damaged.

Battery Installation

! This product contains a rechargeable lithium battery. The product and battery must be disposed of properly. Discarding in a landfill or dumping ground can result to hazardous substances being leaked into the groundwater.

-Robot initially comes with the lithium battery installed.

1. Turn off the robot by flipping the power switch on the side of the robot.

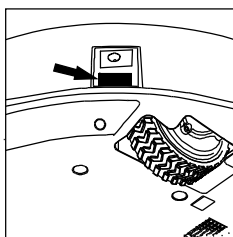

2. Gently pick up the robot and lay it with its wheels facing up.

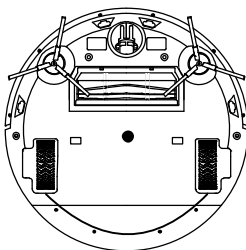

3. Using a screwdriver unscrew the four screws from the half-circle shaped bottom shell and remove the cover.

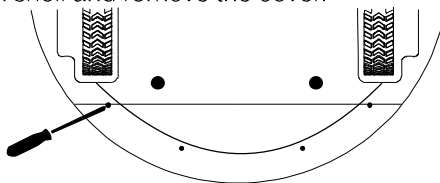

- Pick up the blue lithium battery and its snap joint containing red, yellow and black wires from its hollow holding space by pulling on the clear "pull" tabs located on both sides of the battery.

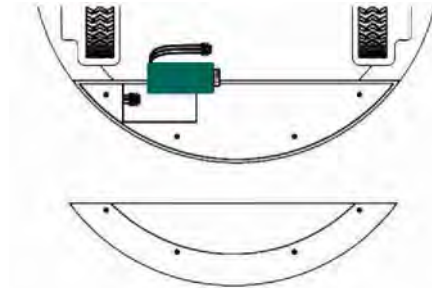

- Connect the snap joint containing the wires on the battery to the snap joint containing the wires at the bottom of the hollow compartment.

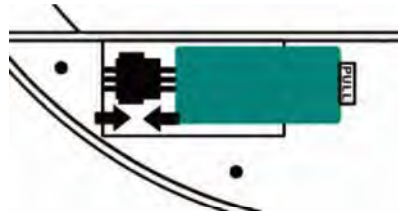

- Place the battery into the compartment with the white label sticker facing up and the two "pull" tabs sticking up for easy removal.
- Place the snap joint connecting the red, yellow and black wires on top of the battery.

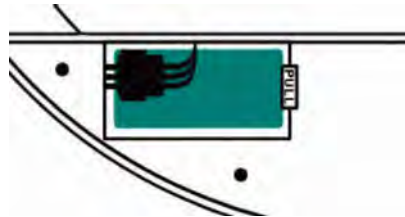

- Replace the half-circle shaped bottom shell and screw in the four screws with a screwdriver into their corresponding locations.

! Disconnect the snap joint of the battery before storing the robot for an extended period.

Installation and Removal of the Sweeping Bracket

! The roller brush must be installed before the sweeping bracket.

- Robot initially comes with the sweeping bracket installed.

1. Turn off the power to the robot by flipping the power switch located on the side of the robot.

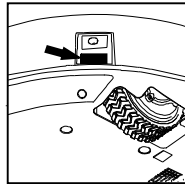

2. Gently pick up the robot and lay it with its wheels facing up.

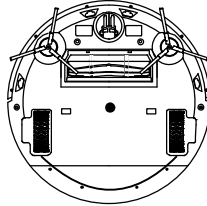

3. Taking the sweeping bracket with the rubber extension facing up, insert the two front prongs into the corresponding holes in the same hollow compartment containing the roller brush.



4. Lower the left and right U-shaped clips located on the sides of the sweeping bracket into their corresponding holes until a click is heard.

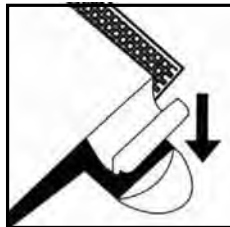

-Follow the same steps for the removal of the sweeping bracket.

Installation and Removal of the Roller Brush

! The roller brush must be installed before the sweeping bracket.

- Robot initially comes with the roller brush installed.

1. Turn off the power to the robot by flipping the power switch

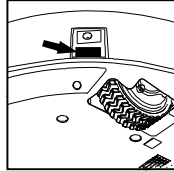

2. Gently pick up the robot and lay it with its wheels facing up.

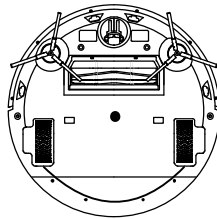

3. Insert the roller brush into the hollow section in between the two side brushes by placing the square spoke on the brush into the corresponding square hole on the left side of the hollow compartment.

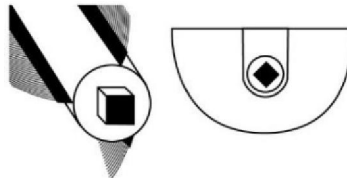

4. Lower the other side of the roller brush by inserting the rubber piece of the roller brush into the semi-circle slot on the right side of the hollow compartment.

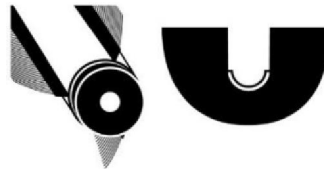

-Follow the same steps for the removal of the roller brush.

Cleaning Your Robot

For your robot to clean at his maximum potential, be sure to clean him once every two weeks and empty his dust bins before each cleaning!

! Ensure that all parts are dry before reassembling the robot.

Part	Required Care
Mop Pads	Hand wash using cleaning solution and water. Allow to dry completely.
Sensors	Use a clean, dry cloth to lightly dust-off dirt.
Side Wheels Universal Wheel	Use the small brush on top of the large dustbin to dust off any debris or remove objects lodged in the wheels. Use scissors to detangle hair buildup if necessary.
Side Brushes Sweeping Bracket	Use the small brush or a damp cloth to remove any debris or dirt.
Charging Dock	Wipe the two recharging poles and the IR Signal Emission Window using a clean, dry cloth.

Cleaning the Exterior of the Robot

1. Turn off the power to the robot by flipping the power switch

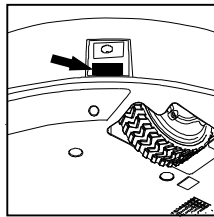

2. Gently wipe down the robot with a damp cloth.
 - Do not get water on the sensors or in the openings.
 - Do not submerge or pour water or other solutions onto the robot.

Cleaning of the Large and Small Dust Bin

1. Remove the dust bin from robot by pulling the handle straight up. Open the latch containing all the dirt and debris and discard. The small brush located on the top of the large dust bin can be used to help clean.

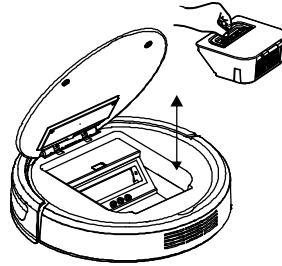

2. Remove the filter by pulling it straight up out of the container and releasing it from the prongs of the dust bin. Take the filter screen out of the filter by pulling the fabric tab of the filter screen. Brush the dirt out with the small brush.

! Do not flip over robot while the dust bin is full.

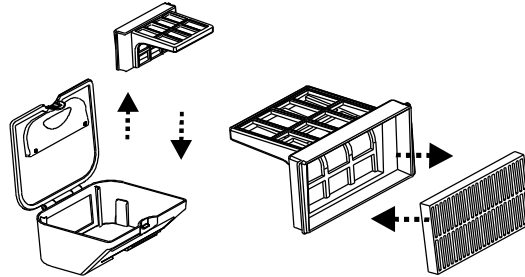

-The HEPA filter should be replaced every 3-6 months and cleaned weekly if used regularly.

-The dust bin can be more thoroughly cleaned by rinsing with water and drying completely before being reinstalled.

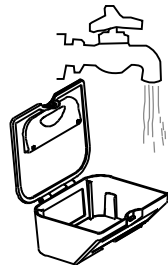

Cleaning the Roller Brush

1. Remove the sweeping bracket from robot (see "Installation and Removal of the Sweeping Bracket" on page 35).
2. Remove the roller brush from robot (see "Installation and Removal of the Roller Brush" on page 34).
3. Use the pick end of the small brush located on the top of the large dust bin to help untangle any debris on the brush strips and the rubber stopper.

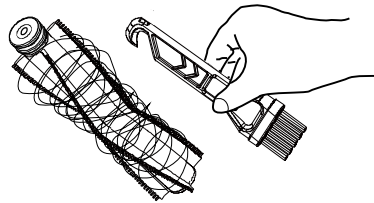

! To avoid buildup of hair and debris around the roller brush, clean the roller brush regularly. Scissors may be used to untangle the roller brush.

Failures and Troubleshooting

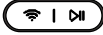
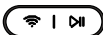
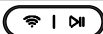
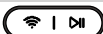
Failure Code	Cause	Troubleshooting
 Two red light is normal on	Low battery.	Move the robot to the charging dock or plug it into the power adapter.
 Two red light is blinking	No dustbin	Property place the dustbin and push it heavily.
 Two blue light is blinking	Battery failure.	Check if the battery is installed correctly (see "Battery Installation")
 Two green light is normal on	Front bumper failure.	Push hard on the front bumper to test if the bumper will resist.
 Red+blue light is normal on	Wall detection failure.	Clean the front bumper and the sensor window.
 Red+green light is normal on	Ground sensor failure.	Clean the cliff sensors underneath the robot or pick up and move the robot to another position.
 Blue+red light is normal on	Left or right wheel lifted.	Put the wheels back on the ground or pick up and move the robot to another position.
 Blue+green light is normal on	Suction inlet is blocked.	Clean the objects off the sensors and the suction inlet.
 Green+red light is normal on	Side brush, roller brush, left or right wheel failure.	Clean the side brush, roller brush, left or right wheels.

FAQ

1. How can I keep robot off unwanted areas?

Create sturdy barriers using household items or close doors to section off areas.

2. Can I have the trailing bar and mop attachment on robot while dry cleaning?

Yes. Attach the trailing bar and mop before dry cleaning for a dry mop cleaning with vacuuming.

3. Can I use the power adapter instead of the charging dock to charge robot?

Yes. The power adapter or charging dock can be used for charging. Ensure that robot's power switch is on before charging.

4. Can I use cleaning solution instead of water when wet mop cleaning?

Yes. For best results dilute the cleaning solution with water before pouring into the tank.

5. How often should the dust bins be emptied?

For best results empty the dust bins before each cleaning session.

6. What should I do if robot cannot find the charging dock?

If robot cannot find the charging dock, manually guide it to the charging dock by using the arrows on the remote or pick up robot and place it on the charging dock.



The robot might have difficulty finding the charging dock in a larger room or a room full of obstacles.

7. How can I protect my robot from falling down my stairs?

The robot has four cliff detecting sensors that will not allow it to fall down stairs. However, if the flooring is a dark color or there is low lighting, robot's sensors may not be able to avoid stairs or running into an object.

8. How long will the robot's battery last?

The lithium battery will last over 500 cleaning and recharging sessions. There is a one-year warranty on the battery.

Dimensions and Parameters

Technical Specification for the Robot

No.	Item	Index Parameter
1	Rated voltage	DC 14.8V
2	Rated power	(30W)
3	Operating temperature range	14°F~113°F
4	Input voltage/current	DC 19V/0.6A
5	Infrared remote control	38KHZ
6	Dimension	∅ 13.8 in × 3.4 in
7	Weight	6.4 lb.
8	Battery	Lithium-ion 2200 mAh
9	Dust bin capacity	0.9 L
10	Small dust bin and tank	0.25 L, 0.6 L

Technical Specification for the Charging Dock

No.	Item	Index Parameter
1	Dimension	L×W×H: 7.6×0.6×4.1 in
2	Input voltage/current	DC 19V/0.6A
3	Operating temperature range	14°F~113°F
4	Operating humidity range	≤85 RH

Technical Specification for the Remote Control

No.	Item	Index Parameter
1	Dimension	L×W×H: 5.7×1.8×0.6 in
2	Battery	2× AAA
3	Remote control method	Infrared
4	Emitting and receiving distance	≤ 16.4 ft.
5	Operating temperature range	14°F~113°F
6	Operating humidity range	≤85 RH

FCC Instructions

This product has been tested and found to comply with the limits for a Class B digital device, pursuant to Part 15 of the FCC Rules. These limits are designed to provide reasonable protection against harmful interference in a residential installation. This product generates, uses and can radiate radio frequency energy and, if not installed and used in accordance with the instructions, may cause harmful interference to radio communications. However, there is no guarantee that interference will not occur in a particular installation. If the product does cause harmful interference to radio or television reception, which can be determined by turning the equipment off and on, the user is encouraged to try to correct the interference by one or more of the following measures :

- Reorient or relocate the receiving antenna.
- Increase the separation between the product and receiver.
- Connect the product into an outlet on a circuit different from that to which the receiver is connected.
- Consult the dealer or an experienced radio/TV technician for help.

This device complies with Part 15 of the FCC Rules. Operation is subject to the following two conditions: (1) this device may not cause harmful interference, and (2) this device must accept any interference received, including interference that may cause undesired operation.

Warning: Changes or modifications not expressly approved by the party responsible for compliance could void the user's authority to operate the product.

FCC Radiation Exposure Statement:

The equipment complies with FCC Radiation exposure limits set forth for uncontrolled environment. This equipment should be installed and operated with minimum distance 20cm between the radiator and your body.