

**GYROSCOPE NAVIGATION ROBOTIC VACUUM CLEANER
WITH WIFI
WITH INTELLIGENT WATER TANK FOR WET MOPPING**

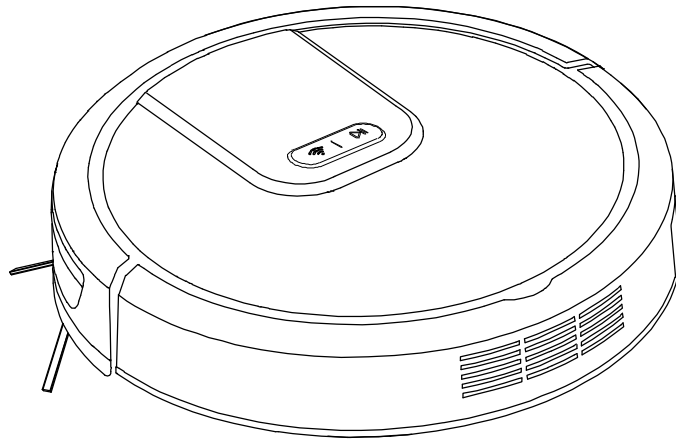

Thank you for purchasing the product. Please read through the instructions before use.

Table of Contents

• Safety.....	1
• Functionality Overview.....	2
a. Advanced Features Summary.....	2
• Parts Included.....	3
• Examination	5
a. Robot.....	5
b. Charging Dock.....	8
c. Panel.....	9
d. Remote.....	10
• Before You Start.....	11
a. Side Brush Installation.....	11
b. Charging Dock Setup.....	12
c. Charge Robot	13
d. Remote Battery Installation.....	15
• Cleaning Options.....	16
a. Dry Cleaning.....	16
b. Wet Cleaning.....	17
• Feature Installations.....	18
a. Installation of the Large Dust Bin.....	18
b. Installation of the Trailing Bar and Mop.....	19
c. Installation of the Tank.....	20
d. Setting the Intelligent Tank.....	22
• Advanced Cleaning.....	23
a. Turbo.....	23
b. Wall Following.....	23
c. Spot.....	24
d. Full Go.....	24
• Finishing a Cleaning Session.....	25
• Time and Date Settings.....	26
a. Programming the Time and Date.....	26
b. Scheduling a Routine Cleaning.....	26
• Maintenance.....	27
a. Removal of the Side Brushes.....	27
b. Battery Installation.....	28
c. Installation and Removal of the Roller Brush.....	30
d. Installation and Removal of the Sweeping Bracket.....	31
• Cleaning Your Robot.....	32
• Failures and Troubleshooting.....	35
a. Error Codes.....	35
b. FAQ.....	36
• Dimensions and Parameters.....	37

Safety

Before using product , read the following safety instructions and follow routine safety precautions.

Oppositions to this manual may result in harm to the user or the product.

This product contains a rechargeable lithium battery. The product and battery must be disposed of properly. Discarding in a landfill or dumping ground can result to hazardous substances being leaked into the groundwater.

WARNING

- Only certified service technicians may disassemble, repair or modify the product.
- Do not touch any cord from the robot with wet hands
- Avoid contact of body parts (head, fingers, etc.) and clothing with the robot's brush or wheels.
- Do not use any charger other than the one provided with the robot.
- Keep the robot away from heat source objects (cigarettes, lighters, matches, etc.) and flammable materials.
- Turn off the power to the robot before transporting or storing for a long period of time to prevent battery damage.
- Use the robot with caution around young children and animals.
- Do not allow the robot to clean up after animal droppings.
- Children, elderly or people with mental inabilities should be monitored or have a full understanding of the product before operating the robot.
- Outdoor use is strictly prohibited.
- The robot should only be charged in inside locations.
- The robot should only be operated and contained at room temperatures.
- Do not let the robot intake any liquids.
- Remove all fragile or damaging items (glass, luminous objects, fabrics) before operating.
- Cleaning should only take place in locations without electrical outlets on the floor.
- Do not place the robot on any high surfaces for cleaning.
- Do not place objects on top of the robot.
- Do not stand or sit on top of the robot.

Functionality Overview

Congratulations on your adoption of Robot, your new personal cyborg. Robot is an intelligent and independent robotic vacuum who's avid about self-cleaning and disinfecting floors including tile, vinyl, wood, linoleum and low-pile carpet. For the best performance, take a few minutes to read this manual. Robot possesses many advanced features and is ready for any task you may ask of him.

Advanced Features Summary

Easy automatic cleaning push to start button for all ages.	HEPA filter traps harmful allergens and pet dander.
Roller brush and sweeping bracket combination easily picks up and traps pet hair.	Dual purpose machine used for both vacuum cleaning and wet mopping.
Infrared sensors and four cliff detectors protect the robot from collisions, stairs and uneven flooring.	Two wet mopping modes to preserve flooring while cleaning: standard and quick seeping modes.
Vacuum sweep method is compatible with all floor types and completes easy transitions from hard floorings to carpet.	Robot vacuums seconds before wet mopping with the tank and dust bin combination.
Spot, wall following and full go cleaning for a more precise clean.	Scheduled cleanings for automatic cleaning without user supervision.
Environmentally conscious with 3D level filter and HEPA filter combination to prevent secondary air pollution.	Low height of 3.4 inches to easily maneuver and clean hard to reach places.
Instructive voice prompts and error codes to help lead user to success.	Wide Wheel design to avoid slipping in all cleaning modes and flooring.
Automatic adjustments to increase suction power when a large amount of debris is detected.	

Parts Included

Robot × 1

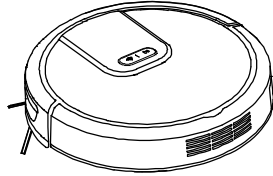

Charging Dock × 1

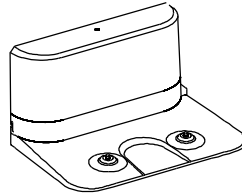

Trailing Bar × 1

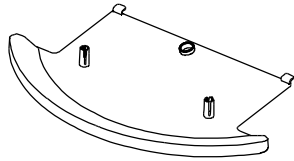

Mop Pad × 2

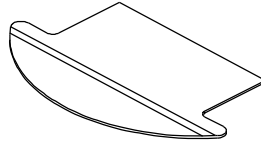

Large Dust Bin × 1

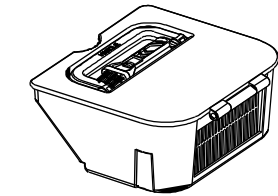

Cleaning Brush × 1
(Attached on large dust bin.)

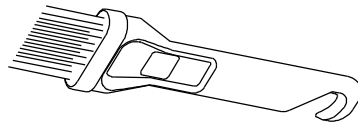

Small Dust Bin × 1

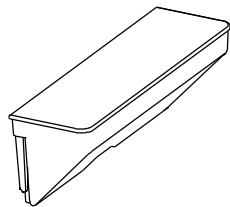

Tank × 1

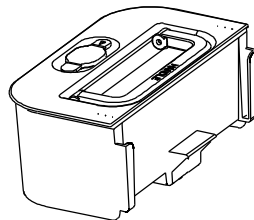

Power Adapter × 1

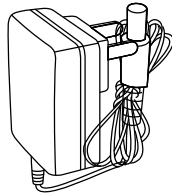

HEPA Filter × 2

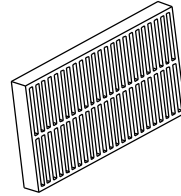

Sweeping Bracket × 1

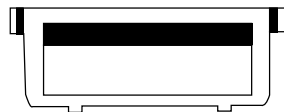

Roller Brush × 1

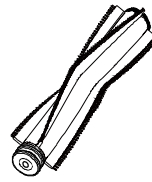

Side Brush × 4

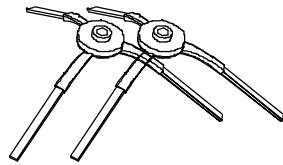

Remote Control × 1

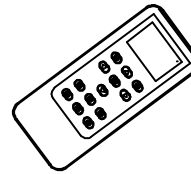

Owner's Manual × 1

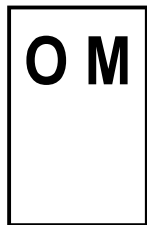

Examination

Robot Top View

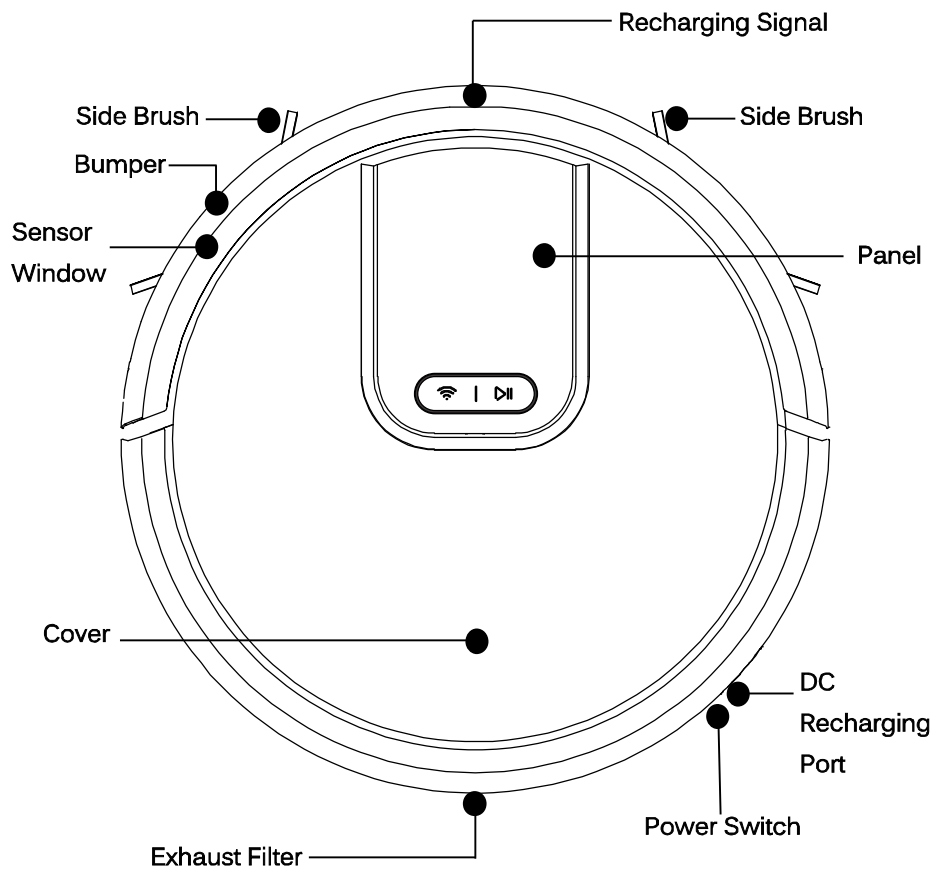

Robot Bottom View

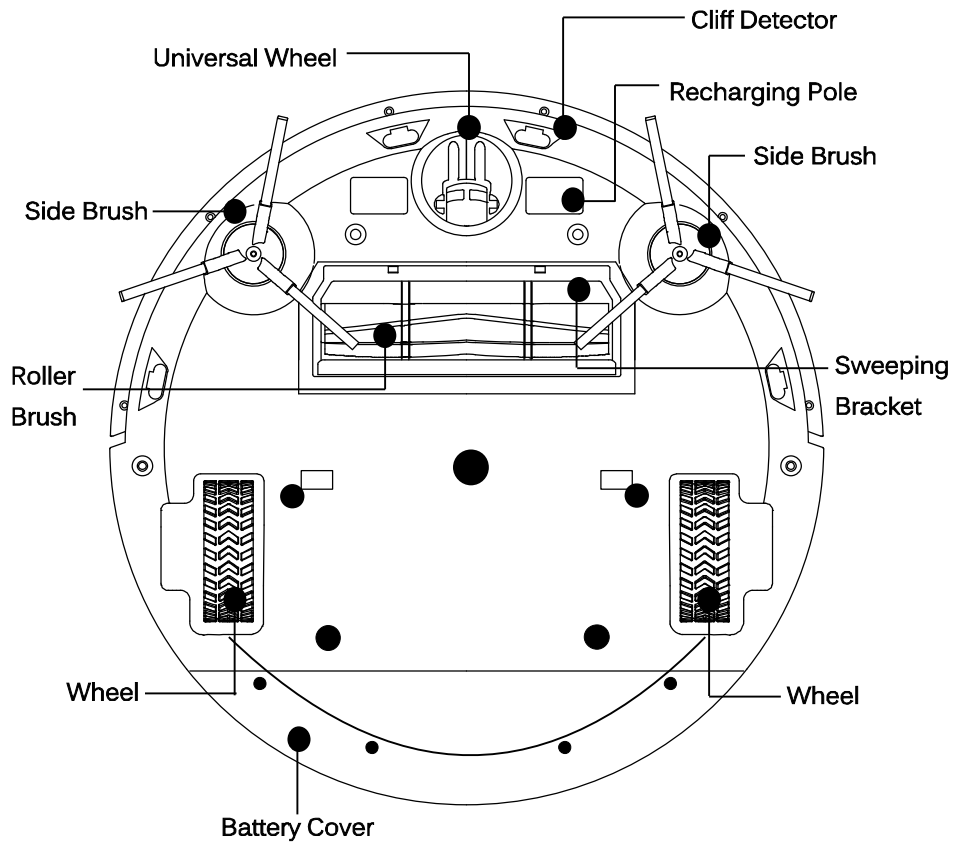

Robot Bottom View with Mopping Accessories

! Robot comes with one of the mop pads and the trailing bar already installed. The trailing bar's main function is to attach the mop pad to the robot and is located underneath the mop pad.

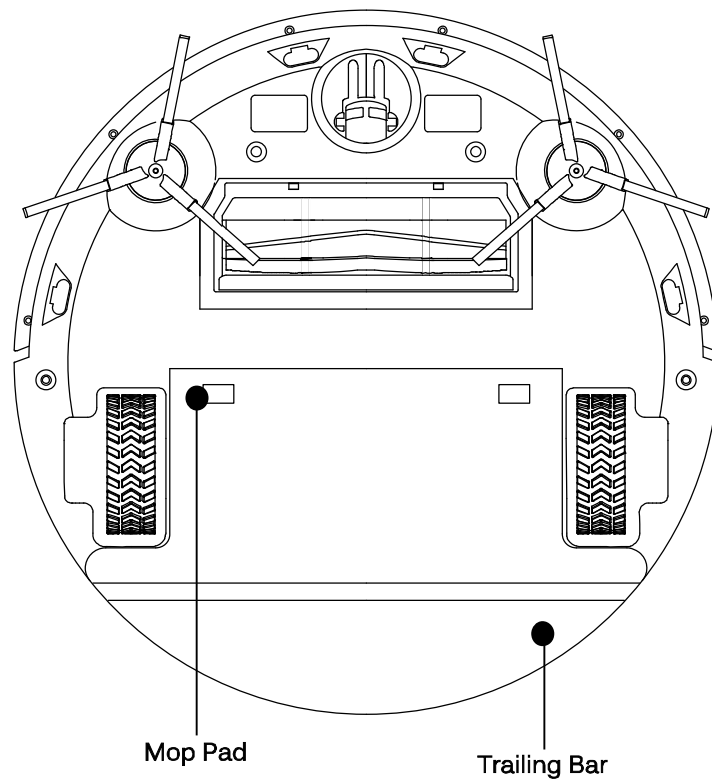

Charging Dock

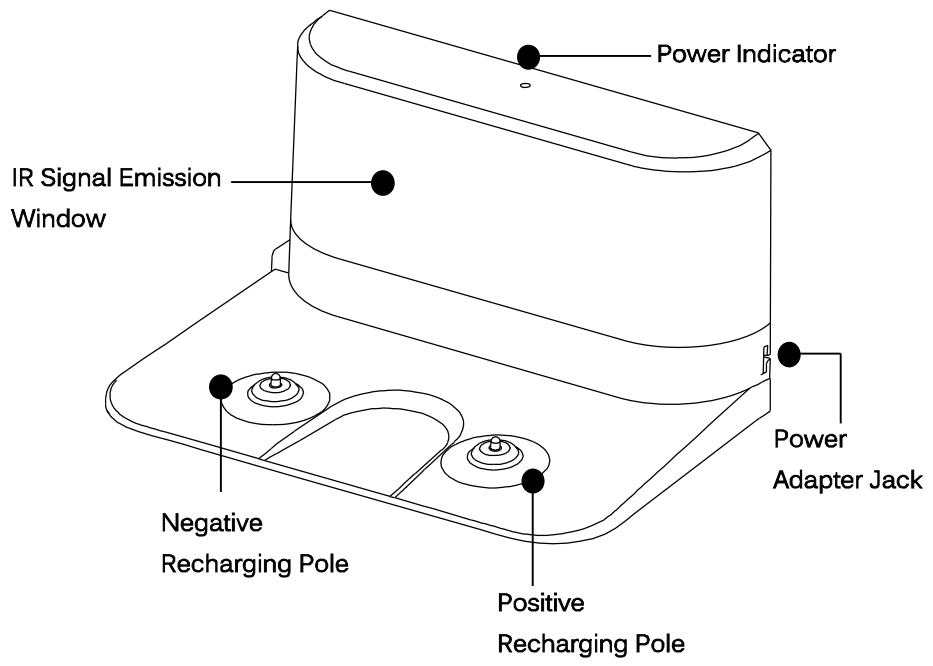

Panel

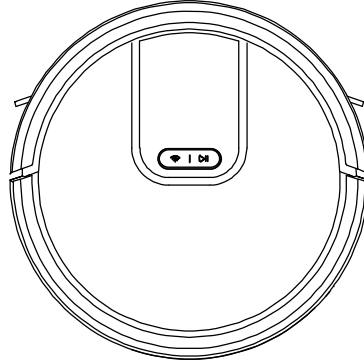

Automatic Cleaning- Press this button while in standby mode and the robot will begin to clean. Press this button while the robot is cleaning to stop the cleaning session. This button blue light is normal on means the robot is working.



WIFI Button- Press and hold this button while in standby mode and you can hear a sound "Di" the robot will enter WIFI mode. (see the WIFI manual)









This two green light is normal on means the robot is in stand by mode

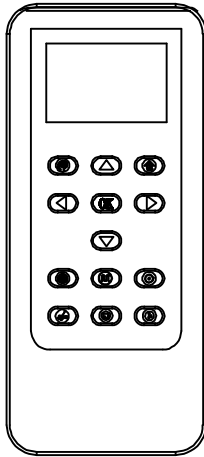









This two button light is off means the robot enter to the sleep mode or the robot is charged full.

Remote



-  Schedule-Press this button and the robot will enter schedule mode.
-  Return Home- Press for the robot to stop cleaning and return to the charging dock.
-  Forward- Press while cleaning and the robot will move in a forward direction.
-  Backwards- Press while cleaning and the robot will move in a backwards direction.
-  Left- Press while cleaning and the robot will turn in a circle to the left.
-  Right- Press while cleaning and the robot will turn in a circle to the right.

-  Press this button and the robot will enter  cleaning mode until another button is pressed.
-  Turbo- Press this button and the robot will enter turbo cleaning and the suction power will increase until another button is pressed.
-  Wall Following- Press this button and the robot will enter wall following mode until finished or another button is pressed.
-  Spot Cleaning- Press this button and the robot will enter spot cleaning mode until finished or another button is pressed.
-  Full Go- Press this button and the robot will enter full go cleaning mode until finished or another button is pressed.
- Press this button start to cleaning mode.
-  Press this button and the robot will confirm to enter settings of schedule mode. In any cleaning mode, press this button to stop it.
-  Tank-Press this button and the robot will enter standard seeping mode and quick seeping mode choice.

Before You Start

The following steps must take place before a cleaning session is to occur.

1. Side Brush Installation

1. Ensure that the robot's power is off. Turn off the power by flipping the power switch on the side of the robot.

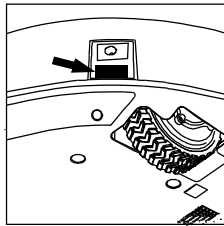

2. Gently pick up the robot and lay it with its wheels facing up.

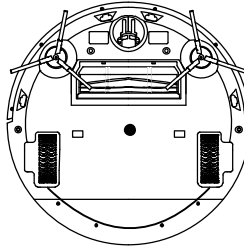

3. Position the side brush with the square hole pointed down and the brush bristles angled up. Align the square hole on the underside of the side brush to the square spoke located inside the hollow semi-circle next to the universal wheel. Push down until a click is heard.

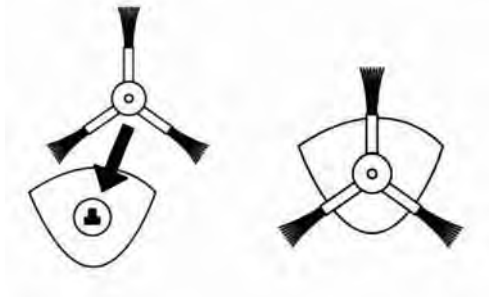

! The side brushes need to be installed before any cleaning takes place

2. Charging Dock Setup

1. Place the charging dock in a position flat on the ground with the back pushed up against a wall. There should be no other objects or obstructions two meters in front of and one meter to the left, right and above the charging dock.

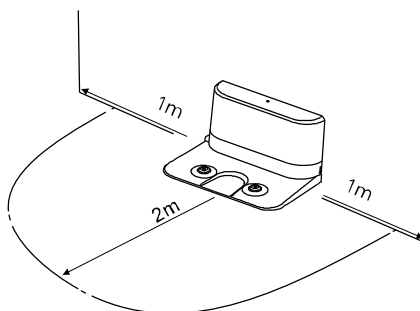

! If the IR signal emission window is blocked, the robot will be unable to locate the charging dock station.

2. Connect the power adapter to the power adapter jack on the charging dock.
3. Locate an electrical outlet on the wall close to the ground and plug in the power adapter. The power indicator on top of the charging dock will emit a red light.

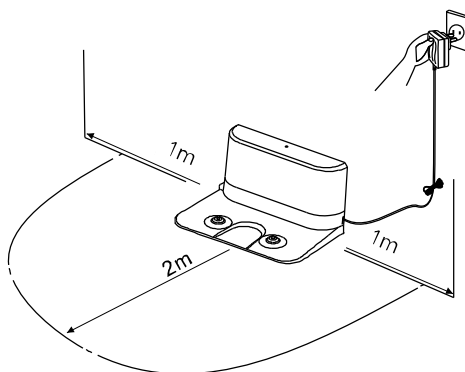

4. Tidy the excess cord from the power adapter by wrapping it around the prongs on the back side of the charging dock.

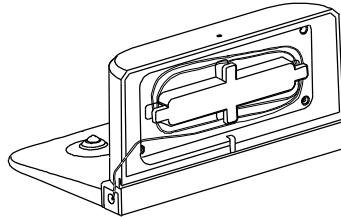

-The cord should not be on the ground or obstructing the charging dock as it will result in the robot being unable to find the charging dock.

-The charging dock should always be plugged in to ensure charging when needed.

! Robot might have difficulty finding the charging dock in a larger room or a room full of obstacles.

3. Charge robot

1. Setup the charging dock using the “Charging Dock Setup” steps.
2. Place the robot on top of the charging dock and align the recharging signal on top of the robot to the red light on the charging dock.

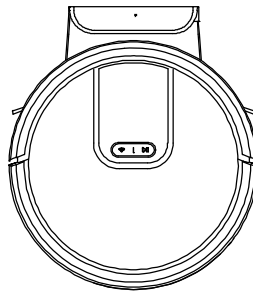

3. Turn on the power switch on the side of the robot.

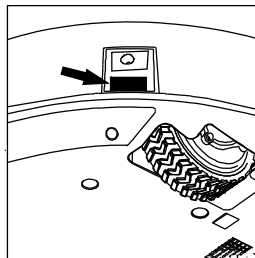

4. Charging

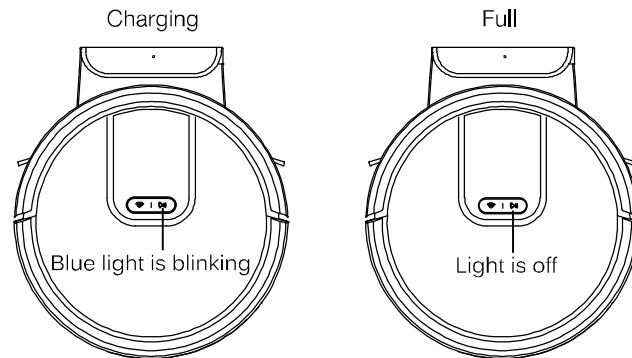

! Leave the robot on the charging dock for at least 8 hours before the first cleaning session. After the first cleaning session, allow robot to charge for at least 16 hours before reuse.

5. Robot is ready for use and has a battery life around 90 minutes.

- Robot can also be charged by connecting the power adapter to the DC recharging port on the side of the robot.



- The average charging time between cleanings is around 3 hours.
- The battery will not be at its full potential until after 2 to 3 cleaning and recharging sessions.
- If the robot is not used on a regular basis recharge the robot once a month to maintain the battery.

4. Remote Battery Installation

1. Remove the battery cover located on the backside of the remote.
2. Place two AAA batteries in the compartment in the correct polarity.
-Batteries are not included in the packaging.
3. Replace the battery cover compartment.

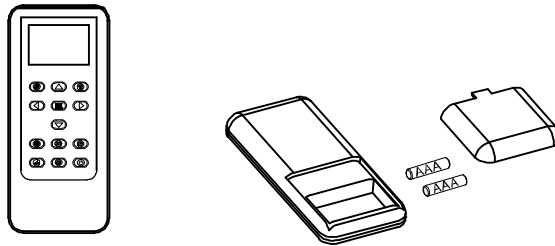



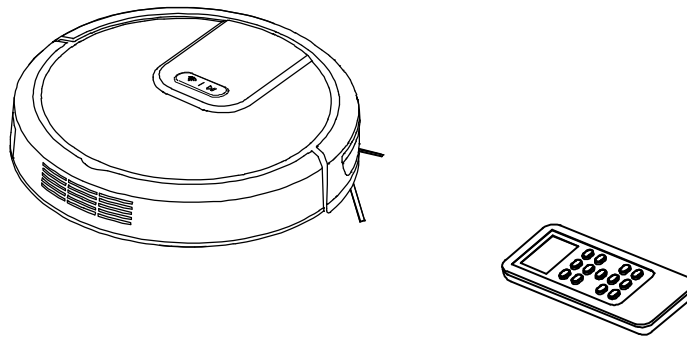

-When in use, the remote should be pointed at the sensor head of the robot within 5 meters≈ 16 feet of the robot for the best results.



Cleaning Options

Robot possesses two distinct cleaning methods: dry and wet cleaning. The dry cleaning method involves a vacuum sweep cleaning perfect for both hard flooring and low-pile carpet. Robot's strong suction will trap debris, hair and allergens. On the other hand, the wet cleaning method showcases a vacuum and mop cleaning perfect for all hard floorings. With a programmable tank to protect floors, Robot will vacuum and collect dirt and debris seconds before mopping.

! The following cleaning options are performed under a robot led path.



For a user led path use the , ,  and  buttons on the remote to control robot's path for directed cleaning.

! Robot only has front sensors, be careful not to lead him off a cliff or into an obstacle while directing him backwards.

Dry Cleaning

Vacuum Sweep Cleaning

-A dry vacuum-sweep cleaning method that collects and traps dirt and debris from the help of the side brushes and strong suction. Suitable for all types of flooring.

1. Set up the charging dock in an approved position (see "Charging Dock Station Setup" on page 14). Ensure the power cord connected to the charging dock is not laying on the ground.
2. Insert the large dust bin (see "Installation of the Large Dust Bin" on page 20).
3. Tidy up the room being cleaned including moving small objects and obstacles.
4. Place robot on the ground, flip the power switch on the side or press the  button to turn the robot on.
5. Press the  command on the panel or the  button on the remote for robot to start.



-For dry mopping, attach the trailing bar and a clean, dry mop pad before cleaning.

Wet Cleaning

Vacuum and Mop Cleaning

-A duo cleaning between the vacuum sweep method and the wet mop. Robot collects dirt and debris seconds before mopping. With two programmable sweeping modes available to protect flooring types.

-Block robot from carpet and rugs while using this method.

1. Set up the charging dock in an approved position (see "Charging Dock Station Setup" on page 14). Ensure the power cord connected to the charging dock is not laying on the ground.
2. Tidy up the room being cleaned including moving small objects, potential obstacles and any rugs.
3. Attach the trailing bar and mop to robot (see "Installation of the Trailing Bar and Mop" on page 21).
4. Prepare the tank with preferred cleaning solution and the small dust bin and insert into robot (see "Installation of the Tank" on page 22).
6. Place robot on the ground, flip the power switch on the side to turn robot on or press the  button to go into standby mode.
7. Program robot for the correct flooring (see "Setting the Intelligent Tank" on page 24).
8. Press the  command on the panel or the  button on the remote for robot to start.

-For the best results, ensure the tank is completely filled with solution and the mop attachment is clean before each cleaning.

! The robot will occasionally get stuck or have difficulty navigating around furniture while cleaning. After a couple minutes of maneuvering, robot will be able to get himself unstuck and return to cleaning. User may direct robot out of an obstacle using the remote if desired.

! Block robot from cleaning undesired areas by creating barriers with household items or closing doors. Fold loose edges and tassels under rugs so they do not get stuck in the robot's suction. Lift blinds and cords.

! Do not allow robot to inhale liquids while cleaning.

Feature Installation

Installation of the Dust Bin

- Robot initially comes with the dust bin installed.

1. Pull up at "Pull" position on the top cover of the robot for the cover to open and expose its containments.

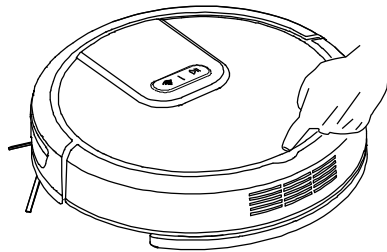

2. Lift the handle on the dust bin to lift the whole container. Insert the dust bin with the filter facing the exhaust filter of the robot and the handle exposed.

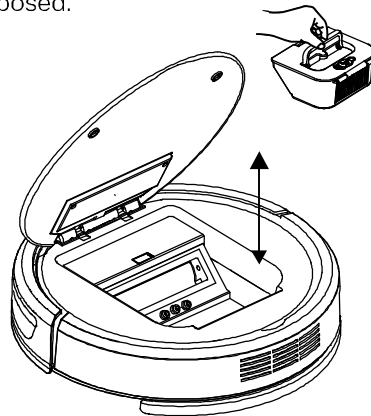

3. Lower the cover until it returns to its preexisting position and a click is heard.

-For the best results, empty the dust bin after each cleaning.