

Bestway (Hong Kong) International Ltd.

RF TEST REPORT

Report Type:

FCC Part 15.247 & ISED RSS-247 RF report

Model:

S200206,
S300206

REPORT NUMBER:

220300150SHA-001

ISSUE DATE:

October 26, 2022

DOCUMENT CONTROL NUMBER:

TTRF15.247-03_V1 © 2018 Intertek



Applicant: Bestway (Hong Kong) International Ltd.
SUITE 713, 7/FLOOR, EAST WING, TSIM SHA TSUI CENTRE, 66 MODY ROAD, KOWLOON, HONG KONG

Manufacturer: Bestway (Hong Kong) International Ltd.
SUITE 713, 7/FLOOR, EAST WING, TSIM SHA TSUI CENTRE, 66 MODY ROAD, KOWLOON, HONG KONG

Factory: Bestway (Nantong) Recreation Corp.
No. 8 Hui Min West Road, Economic Development Zone, Rugao, Jiangsu 226500, P.R. China

FCC ID: 2AS3R-200206

IC: 26017-200206

SUMMARY:

The equipment complies with the requirements according to the following standard(s) or Specification:

47CFR Part 15 (2020): Radio Frequency Devices (Subpart C)

ANSI C63.10 (2013): American National Standard of Procedures for Compliance Testing of Unlicensed Wireless Devices

RSS-247 Issue 2 (February 2017): Digital Transmission Systems (DTSs), Frequency Hopping Systems (FHSs) and Licence-Exempt Local Area Network (LE-LAN) Devices

RSS-Gen Issue 5 (March 2019) Amendment 1: General Requirements for Compliance of Radio Apparatus

PREPARED BY:



Project Engineer
Eric Li

REVIEWED BY:



Reviewer
Wakeyou Wang

This report is for the exclusive use of Intertek's Client and is provided pursuant to the agreement between Intertek and its Client. Intertek's responsibility and liability are limited to the terms and conditions of the agreement. Intertek assumes no liability to any party, other than to the Client in accordance with the agreement, for any loss, expense or damage occasioned by the use of this report. Only the Client is authorized to permit copying or distribution of this report and then only in its entirety. Any use of the Intertek name or one of its marks for the sale or advertisement of the tested material, product or service must first be approved in writing by Intertek. The observations and test results in this report are relevant only to the sample tested. This report by itself does not imply that the material, product, or service is or has ever been under an Intertek certification program.

TEST REPORT

Content

REVISION HISTORY..... 5

MEASUREMENT RESULT SUMMARY 6

1 GENERAL INFORMATION 7

1.1 DESCRIPTION OF EQUIPMENT UNDER TEST (EUT) 7

1.2 TECHNICAL SPECIFICATION 7

1.3 DESCRIPTION OF TEST FACILITY 8

2 TEST SPECIFICATIONS..... 9

2.1 STANDARDS OR SPECIFICATION 9

2.2 MODE OF OPERATION DURING THE TEST..... 9

2.3 TEST SOFTWARE LIST 10

2.4 TEST PERIPHERALS LIST 10

2.5 TEST ENVIRONMENT CONDITION:..... 10

2.6 INSTRUMENT LIST 11

2.7 MEASUREMENT UNCERTAINTY 13

3 MINIMUM 6DB BANDWIDTH..... 14

3.1 LIMIT 14

3.2 MEASUREMENT PROCEDURE 14

3.3 TEST CONFIGURATION 14

3.4 TEST RESULTS OF MINIMUM 6DB BANDWIDTH 14

4 MAXIMUM CONDUCTED OUTPUT POWER AND E.I.R.P..... 15

4.1 LIMIT 15

4.2 MEASUREMENT PROCEDURE 15

4.3 TEST CONFIGURATION 16

4.4 TEST RESULTS OF MAXIMUM CONDUCTED OUTPUT POWER..... 16

5 POWER SPECTRUM DENSITY 17

5.1 LIMIT 17

5.2 MEASUREMENT PROCEDURE 17

5.3 TEST CONFIGURATION 18

5.4 TEST RESULTS OF POWER SPECTRUM DENSITY 18

6 EMISSION OUTSIDE THE FREQUENCY BAND 19

6.1 LIMIT 19

6.2 MEASUREMENT PROCEDURE 19

6.3 TEST CONFIGURATION 20

6.4 THE RESULTS OF EMISSION OUTSIDE THE FREQUENCY BAND..... 20

7 RADIATED EMISSIONS IN RESTRICTED FREQUENCY BANDS..... 21

7.1 LIMIT 21

7.2 MEASUREMENT PROCEDURE 21

7.3 TEST CONFIGURATION 23

7.4 TEST RESULTS OF RADIATED EMISSIONS 25

8 POWER LINE CONDUCTED EMISSION..... 29

8.1 LIMIT 29

8.2 TEST CONFIGURATION 29

8.3 MEASUREMENT PROCEDURE 30

8.4 TEST RESULTS OF POWER LINE CONDUCTED EMISSION..... 31

TEST REPORT

9 OCCUPIED BANDWIDTH 33

9.1 LIMIT 33

9.2 MEASUREMENT PROCEDURE 33

9.3 TEST CONFIGURATION 33

9.4 THE RESULTS OF OCCUPIED BANDWIDTH 33

10 ANTENNA REQUIREMENT 34

APPENDIX A: TEST RESULTS 35

Revision History

Report No.	Version	Description	Issued Date
220300150SHA-001	Rev. 01	Initial issue of report	October 26, 2022

TEST REPORT

Measurement result summary

TEST ITEM	FCC REFERANCE	IC REFERANCE	RESULT
Minimum 6dB Bandwidth	15.247(a)(2)	RSS-247 Issue 2 Clause 5.2	Pass
Maximum conducted output power and e.i.r.p.	15.247(b)(3)	RSS-247 Issue 2 Clause 5.4	Pass
Power spectrum density	15.247(e)	RSS-247 Issue 2 Clause 5.2	Pass
Emission outside the frequency band	15.247(d)	RSS-247 Issue 2 Clause 5.5	Pass
Radiated Emissions in restricted frequency bands	15.247(d), 15.205&15.209	RSS-Gen Issue 5 Clause 8.9&8.10	Pass
Power line conducted emission	15.207(a)	RSS-Gen Issue 5 Clause 8.8	Pass
Occupied bandwidth	-	RSS-Gen Issue 5 Clause 6.6	Tested
Antenna requirement	15.203	-	Pass

Notes: 1: NA =Not Applicable

TEST REPORT

1 GENERAL INFORMATION

1.1 Description of Equipment Under Test (EUT)

Product name:	SPA
Type/Model:	S200206, S300206
Description of EUT:	EUT is a Wireless SPA with BLE and WIFI functions, there are two models, both of them are the same except the physical size and filter, we test the model of S300206 as representative and list the worst results in this report.
Rating:	110-120V~60Hz,12A
EUT type:	<input type="checkbox"/> Tabletop <input checked="" type="checkbox"/> Floor standing
Software Version:	/
Hardware Version:	/
Sample received date:	June 27, 2022
Date of test:	June 28 , 2022~ July 6, 2022

1.2 Technical Specification

Frequency Band:	2400MHz ~ 2483.5MHz
Support Standards:	IEEE 802.11b, IEEE 802.11g, IEEE 802.11n-HT20, IEEE 802.11n-HT40
Type of Modulation:	IEEE 802.11b: DSSS (CCK, DQPSK, DBPSK) IEEE 802.11g: OFDM (64-QAM, 16-QAM, QPSK, BPSK) IEEE 802.11n-HT20: OFDM (64-QAM, 16-QAM, QPSK, BPSK) IEEE 802.11n-HT40: OFDM (64-QAM, 16-QAM, QPSK, BPSK)
Channel Number:	11 Channels for 802.11b, 802.11g and 802.11n(HT20) 7 Channels for 802.11n(HT40)
Channel Separation:	5 MHz
Antenna:	FPC Antenna, 2.0dBi

TEST REPORT

1.3 Description of Test Facility

Name:	Intertek Testing Services Shanghai
Address:	Building 86, No. 1198 Qinzhou Road (North), Shanghai 200233, P.R. China
Telephone:	86 21 61278200
Telefax:	86 21 54262353

The test facility is recognized, certified, or accredited by these organizations:	CNAS Accreditation Lab Registration No. CNAS L0139
	FCC Accredited Lab Designation Number: CN1175
	IC Registration Lab CAB identifier.: CN0051
	VCCI Registration Lab Registration No.: R-14243, G-10845, C-14723, T-12252
	A2LA Accreditation Lab Certificate Number: 3309.02

TEST REPORT

2 TEST SPECIFICATIONS

2.1 Standards or specification

47CFR Part 15 (2020)
 ANSI C63.10 (2013)
 KDB 558074 (v05r02)
 RSS-247 Issue 2 (February 2017)
 RSS-Gen Issue 5 (March 2019) Amendment 1

2.2 Mode of operation during the test

While testing transmitting mode of EUT, the internal modulation and continuously transmission was applied.

Software name	Manufacturer	Version	Supplied by
ESP_RF_test_tool	/	V2.80	Client

The lowest, middle and highest channel were tested as representatives.

Frequency Band (MHz)	Mode	Lowest (MHz)	Middle (MHz)	Highest (MHz)
2400-2483.5	802.11b	2412	2437	2462
	802.11g	2412	2437	2462
	802.11n(HT20)	2412	2437	2462
	802.11n(HT40)	2422	2437	2452

Data rate and Power setting:

The pre-scan for the conducted power with all rates in each modulation and bands was used, and the worst case was found and used in all test cases. After this pre-scan, we choose the following table of the data rata as the worst case.

Frequency Band (MHz)	Mode	Worst case data rate	Power Setting
2400-2483.5	802.11b	1Mbps	ATT=30
	802.11g	6Mbps	ATT=30
	802.11n(HT20)	MCS0	ATT=30
	802.11n(HT40)	MCS0	ATT=30

TEST REPORT

2.3 Test software list

Test Items	Software	Manufacturer	Version
Conducted emission	ESxS-K1	R&S	V2.1.0
Radiated emission	ES-K1	R&S	V1.71

2.4 Test peripherals list

Item No.	Name	Band and Model	Description
1	Laptop computer	DELL 5480	-

2.5 Test environment condition:

Test items	Temperature	Humidity
Minimum 6dB Bandwidth	22°C	52%RH
Maximum conducted output power and e.i.r.p.		
Power spectrum density		
Emission outside the frequency band		
Occupied bandwidth		
Radiated Emissions in restricted frequency bands	23°C	52%RH
Power line conducted emission	22°C	52%RH

TEST REPORT

2.6 Instrument list

Conducted Emission/Disturbance Power/Tri-loop Test/CDN method					
Used	Equipment	Manufacturer	Type	Internal no.	Due date
<input checked="" type="checkbox"/>	Test Receiver	R&S	ESCS 30	EC 2107	2022-07-09
<input checked="" type="checkbox"/>	A.M.N.	R&S	ESH2-Z5	EC 3119	2022-11-09
<input type="checkbox"/>	A.M.N.	R&S	ENV 216	EC 3393	2022-07-09
<input type="checkbox"/>	A.M.N.	R&S	ENV4200	EC 3558	2023-06-09
Radiated Emission					
Used	Equipment	Manufacturer	Type	Internal no.	Due date
<input checked="" type="checkbox"/>	Test Receiver	R&S	ESIB 26	EC 3045	2022-10-19
<input type="checkbox"/>	Bilog Antenna	TESEQ	CBL 6112B	EC 6411	2022-08-06
<input checked="" type="checkbox"/>	TRILOG broadband Antenna	Schwarzbeck	VULB9168	EC6402	2023-01-17
<input checked="" type="checkbox"/>	Pre-amplifier	R&S	AFS42-00101800-25-S-42	EC5262	2023-06-09
<input type="checkbox"/>	Pre-amplifier	tonscend	tap01018050	EC 6432-1	2022-12-26
<input type="checkbox"/>	Horn antenna	tonscend	bha9120d	EC 6432-2	2023-01-09
<input checked="" type="checkbox"/>	Horn antenna	ETS	3117	EC 4792-1	2023-03-27
<input type="checkbox"/>	Horn antenna	TOYO	HAP18-26W	EC 4792-3	2023-07-08
<input type="checkbox"/>	Active loop antenna	Schwarzbeck	FMZB1519	EC 5345	2022-04-24
RF test					
Used	Equipment	Manufacturer	Type	Internal no.	Due date
<input type="checkbox"/>	PXA Signal Analyzer	Keysight	N9030A	EC 5338	2023-03-14
<input type="checkbox"/>	Power sensor	Agilent	U2021XA	EC 5338-1	2023-03-14
<input type="checkbox"/>	Vector Signal Generator	Agilent	N5182B	EC 5175	2023-03-14
<input type="checkbox"/>	MXG Analog Signal Generator	Agilent	N5181A	EC 5338-2	2023-03-14
<input type="checkbox"/>	Mobile Test System	Litepoint	lqxel	EC 5176	2023-01-11
<input type="checkbox"/>	Test Receiver	R&S	ESCI 7	EC 4501	2022-12-09
<input type="checkbox"/>	Climate chamber	GWS	MT3065	EC 6021	2023-03-06
<input checked="" type="checkbox"/>	Spectrum Analyzer	Keysight	N9030b	EC 6078	2023-06-09
<input type="checkbox"/>	Signal generator	Agilent	N5182A	Ec6172	2022-08-19
<input type="checkbox"/>	Signal generator	Agilent	N5181A	Ec6171	2022-08-19
Tet Site					
Used	Equipment	Manufacturer	Type	Internal no.	Due date

TEST REPORT

<input checked="" type="checkbox"/>	Shielded room	Zhongyu	-	EC 2838	2023-01-11
<input type="checkbox"/>	Shielded room	Zhongyu	-	EC 2839	2023-01-11
<input checked="" type="checkbox"/>	Semi-anechoic chamber	Albatross project	-	EC 3048	2022-08-22
<input checked="" type="checkbox"/>	Fully-anechoic chamber	Albatross project	-	EC 3047	2022-08-22
Additional instrument					
Used	Equipment	Manufacturer	Type	Internal no.	Due date
<input checked="" type="checkbox"/>	Thermo-Hygrograph	ZJ1-2A	S.M.I.F.	EC 3783	2023-03-24
<input type="checkbox"/>	Thermo-Hygrograph	ZJ1-2A	S.M.I.F.	EC 5198	2023-03-08
<input checked="" type="checkbox"/>	Thermo-Hygrograph	ZJ1-2A	S.M.I.F.	EC 3442	2023-01-03
<input checked="" type="checkbox"/>	Thermo-Hygrograph	ZJ1-2A	S.M.I.F.	EC 5844	2023-03-08
<input type="checkbox"/>	Pressure meter	YM3	Shanghai Mengde	EC 3320	2022-07-22

TEST REPORT

2.7 Measurement uncertainty

The measurement uncertainty represents an expanded uncertainty expressed at approximately the 95% confidence level using a coverage factor of k=2.

Test item	Measurement uncertainty
Maximum peak output power	± 0.74dB
Radiated Emissions in restricted frequency bands below 1GHz	± 4.90dB
Radiated Emissions in restricted frequency bands above 1GHz	± 5.02dB
Emission outside the frequency band	± 2.89dB
Power line conducted emission	± 3.19dB

TEST REPORT

3 Minimum 6dB bandwidth

Test result: Pass

3.1 Limit

For systems using digital modulation techniques that may operate in the 902 - 928 MHz, 2400 - 2483.5 MHz and 5725 - 5850 MHz bands, the minimum 6 dB bandwidth shall be at least 500 kHz.

3.2 Measurement Procedure

The EUT was tested according to Subclause 11.8 of ANSI C63.10.

- a) Set RBW = 100 kHz.
- b) Set the video bandwidth (VBW) $\geq 3 \times$ RBW.
- c) Detector = Peak.
- d) Trace mode = max hold.
- e) Sweep = auto couple.
- f) Allow the trace to stabilize.
- g) Measure the maximum width of the emission that is constrained by the frequencies associated with the two outermost amplitude points (upper and lower frequencies) that are attenuated by 6 dB relative to the maximum level measured in the fundamental emission.

3.3 Test Configuration



3.4 Test Results of Minimum 6dB bandwidth

Please refer to Appendix A

TEST REPORT**4 Maximum conducted output power and e.i.r.p.****Test result: Pass****4.1 Limit**

For systems using digital modulation in the 902-928 MHz, 2400-2483.5 MHz, and 5725-5850 MHz bands: 1 W. (The e.i.r.p. shall not exceed 4 W)

If the transmitting antenna of directional gain greater than 6dBi is used, the power shall be reduced by the amount in dB that the directional gain of the antenna exceeds 6dBi. If there have a beam forming type, the limit should be the minimum of 30dBm and 30+ (6 –antenna gain-beam forming gain).

4.2 Measurement Procedure

The EUT was tested according to Subclause 11.9.2.2 of ANSI C63.10.

- a) Measure the duty cycle, x , of the transmitter output signal as described in Section 6.0.
- b) Set span to at least $1.5 \times \text{OBW}$.
- c) Set RBW = 1 % to 5 % of the OBW, not to exceed 1 MHz.
- d) Set VBW $\geq 3 \times \text{RBW}$.
- e) Number of points in sweep $\geq 2 \times \text{span} / \text{RBW}$. (This gives bin-to-bin spacing $\leq \text{RBW}/2$, so that narrowband signals are not lost between frequency bins.)
- f) Sweep time = auto.
- g) Detector = RMS (i.e., power averaging), if available. Otherwise, use sample detector mode.
- h) Do not use sweep triggering. Allow the sweep to “free run”.
- i) Trace average at least 100 traces in power averaging (i.e., RMS) mode; however, the number of traces to be averaged shall be increased above 100 as needed such that the average accurately represents the true average over the on and off periods of the transmitter.
- j) Compute power by integrating the spectrum across the OBW of the signal using the instrument’s band power measurement function with band limits set equal to the OBW band edges. If the instrument does not have a band power function, sum the spectrum levels (in power units) at intervals equal to the RBW extending across the entire OBW of the spectrum.
- k) Add $10 \log (1/x)$, where x is the duty cycle, to the measured power in order to compute the average power during the actual transmission times (because the measurement represents an average over both the on- and off-times of the transmission). For example, add $10 \log (1/0.25) = 6 \text{ dB}$ if the duty cycle is 25 %.

TEST REPORT

4.3 Test Configuration

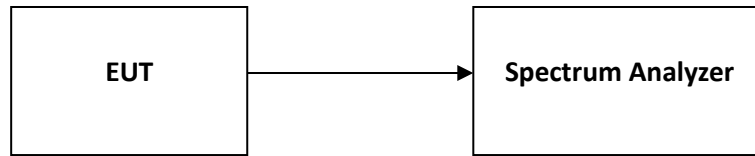

4.4 Test Results of Maximum conducted output power

Please refer to Appendix A

TEST REPORT

5 Power spectrum density

Test result: Pass

5.1 Limit

For digitally modulated systems, the power spectral density conducted from the intentional radiator to the antenna shall not be greater than 8dBm in any 3 kHz band during any time interval of continuous transmission.

If the transmitting antenna of directional gain greater than 6dBi is used, the power shall be reduced by the amount in dB that the directional gain of the antenna exceeds 6dBi. If there have a beam forming type, the limit should be the minimum of 8dBm/MHz and $8 + (6 - \text{antenna gain} - \text{beam forming gain})$.

5.2 Measurement Procedure

The EUT was tested according to Subclause 11.10 of ANSI C63.10.

This procedure is applicable when the EUT cannot be configured to transmit continuously (i.e., duty cycle < 98 %), and when sweep triggering/signal gating cannot be used to measure only when the EUT is transmitting at its maximum power control level, and when the transmission duty cycle is constant (i.e., duty cycle variations are less than $\pm 2\%$):

- a) Measure the duty cycle (x) of the transmitter output signal as described in Section 6.0.
- b) Set instrument center frequency to DTS channel center frequency.
- c) Set span to at least $1.5 \times \text{OBW}$.
- d) Set RBW to: $3 \text{ kHz} \leq \text{RBW} \leq 100 \text{ kHz}$.
- e) Set VBW $\geq 3 \times \text{RBW}$.
- f) Detector = power averaging (RMS) or sample detector (when RMS not available).
- g) Ensure that the number of measurement points in the sweep $\geq 2 \times \text{span}/\text{RBW}$.
- h) Sweep time = auto couple.
- i) Do not use sweep triggering. Allow sweep to “free run”.
- j) Employ trace averaging (RMS) mode over a minimum of 100 traces.
- k) Use the peak marker function to determine the maximum amplitude level.
- l) Add $10 \log(1/x)$, where x is the duty cycle measured in step (a), to the measured PSD to compute the average PSD during the actual transmission time.
- m) If resultant value exceeds the limit, then reduce RBW (no less than 3 kHz) and repeat (note that this may require zooming in on the emission of interest and reducing the span in order to meet the minimum measurement point requirement as the RBW is reduced).

TEST REPORT

5.3 Test Configuration

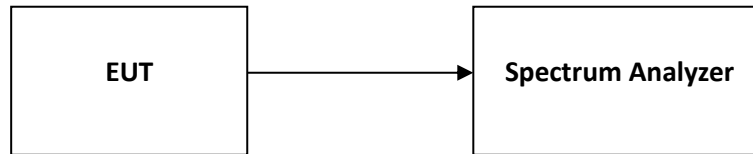

5.4 Test Results of Power spectrum density

Please refer to Appendix A

TEST REPORT**6 Emission outside the frequency band****Test result: Pass****6.1 Limit**

In any 100 kHz bandwidth outside the frequency band in which the spread spectrum intentional radiator is operating, the radio frequency power that is produced by the intentional radiator shall be at least 30 dB below that in the 100 kHz bandwidth within the band that contains the highest level of the desired power.

6.2 Measurement Procedure

The EUT was tested according to Subclause 11.11 of ANSI C63.10.

Reference level measurement

Establish a reference level by using the following procedure:

- a) Set instrument center frequency to DTS channel center frequency.
- b) Set the span to ≥ 1.5 times the DTS bandwidth.
- c) Set the RBW = 100 kHz.
- d) Set the VBW $\geq 3 \times$ RBW.
- e) Detector = peak.
- f) Sweep time = auto couple.
- g) Trace mode = max hold.
- h) Allow trace to fully stabilize.
- i) Use the peak marker function to determine the maximum PSD level.

Emission level measurement

- a) Set the center frequency and span to encompass frequency range to be measured.
- b) Set the RBW = 100 kHz.
- c) Set the VBW $\geq 3 \times$ RBW.
- d) Detector = peak.
- e) Sweep time = auto couple.
- f) Trace mode = max hold.
- g) Allow trace to fully stabilize.
- h) Use the peak marker function to determine the maximum amplitude level.

Ensure that the amplitude of all unwanted emissions outside of the authorized frequency band (excluding restricted frequency bands) are attenuated by at least the minimum requirements specified in 11.1 a) or 11.1 b). Report the three highest emissions relative to the limit.

TEST REPORT

6.3 Test Configuration



6.4 The results of Emission outside the frequency band

Please refer to Appendix A

TEST REPORT

7 Radiated Emissions in restricted frequency bands

Test result: Pass

7.1 Limit

The radiated emissions which fall in the restricted bands, must also comply with the radiated emission limits specified showed as below:

Frequencies (MHz)	Field Strength (microvolts/meter)	Measurement Distance (meters)
0.009 ~ 0.490	2400/F(kHz)	300
0.490 ~ 1.705	24000/F(kHz)	30
1.705 ~ 30.0	30	30
30 ~ 88	100	3
88 ~ 216	150	3
216 ~ 960	200	3
Above 960	500	3

7.2 Measurement Procedure

The EUT was tested according to Subclause 11.12 of ANSI C63.10.

For Radiated emission below 30MHz:

- a) The EUT was placed on the top of a rotating table 0.8 meters above the ground at a 3 meters chamber room. The table was rotated 360 degrees to determine the position of the highest radiation.
- b) The EUT was set 3 meters away from the interference-receiving antenna, which was mounted on the top of a variable-height antenna tower.
- c) Both X and Y axes of the antenna are set to make the measurement.
- d) For each suspected emission, the EUT was arranged to its worst case and the rotatable table was turned from 0 degrees to 360 degrees to find the maximum reading.
- e) The test-receiver system was set to Quasi-Peak Detect Function and Specified Bandwidth with Maximum Hold Mode.

NOTE:

- 1. The resolution bandwidth and video bandwidth of test receiver/spectrum analyzer is 9kHz at frequency below 30MHz.

TEST REPORT**For Radiated emission above 30MHz:**

- a) The EUT was placed on the top of a rotating table 0.8 meters (for 30MHz ~ 1GHz) / 1.5 meters (for above 1GHz) or 0.1 meters (for floor-standing device) above the ground at 3 meters chamber room for test. The table was rotated 360 degrees to determine the position of the highest radiation.
- b) The EUT was set 3 meters away from the interference-receiving antenna, which was mounted on the top of a variable-height antenna tower.
- c) The height of antenna is varied from one meter to four meters above the ground to determine the maximum value of the field strength. Both horizontal and vertical polarizations of the antenna are set to make the measurement.
- d) For each suspected emission, the EUT was arranged to its worst case and then the antenna was tuned to heights from 1 meter to 4 meters and the rotatable table was turned from 0 degrees to 360 degrees to find the maximum reading.
- e) The test-receiver system was set to quasi-peak detect function and specified bandwidth with maximum hold mode when the test frequency is below 1 GHz.
- f) The test-receiver system was set to peak and average detector function and specified bandwidth with maximum hold mode when the test frequency is above 1 GHz. If the peak reading value also meets average limit, measurement with the average detector is unnecessary.

Note:

1. The resolution bandwidth and video bandwidth of test receiver/spectrum analyzer is 120kHz for Quasi-peak detection (QP) at frequency below 1GHz.
2. The resolution bandwidth of test receiver/spectrum analyzer is 1 MHz and the video bandwidth is 3 MHz for Peak detection (PK) at frequency above 1GHz.
3. The resolution bandwidth of test receiver/spectrum analyzer is 1 MHz and the video bandwidth is $\geq 1/T$ (Duty cycle < 98%) or $3 \times \text{RBW}$ (Duty cycle $\geq 98\%$) for Average detection (AV) at frequency above 1GHz.
4. All modes of operation were investigated and the worst-case emissions were reported.

TEST REPORT

7.3 Test Configuration

For Radiated emission below 30MHz:

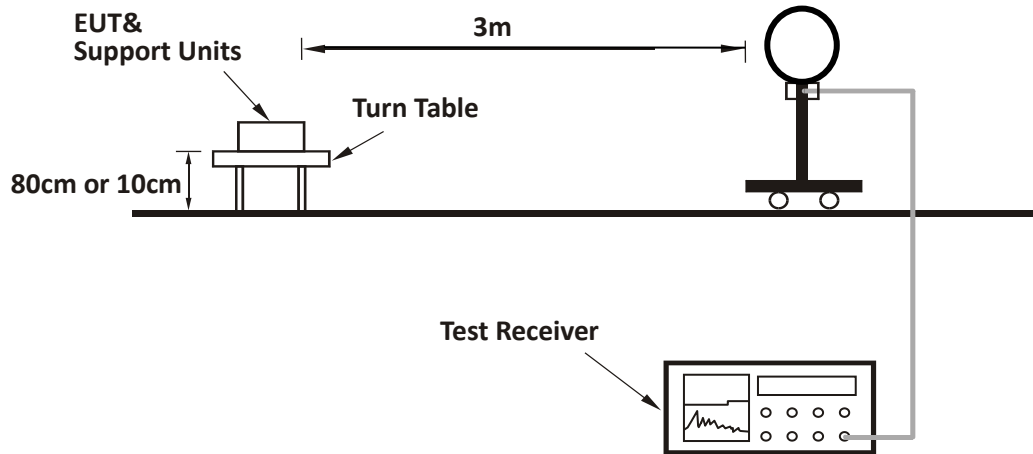

For Radiated emission 30MHz to 1GHz:

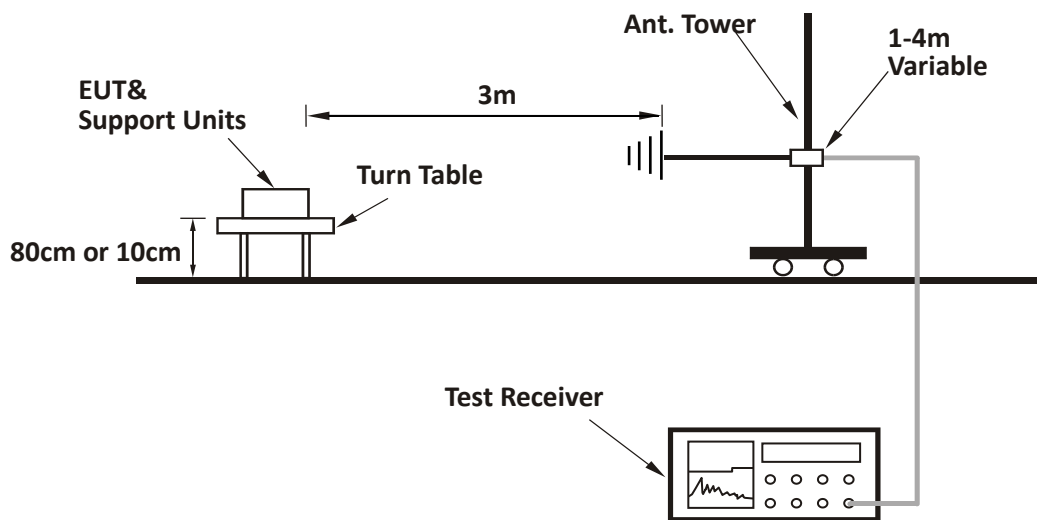

TEST REPORT

For Radiated emission above 1GHz:

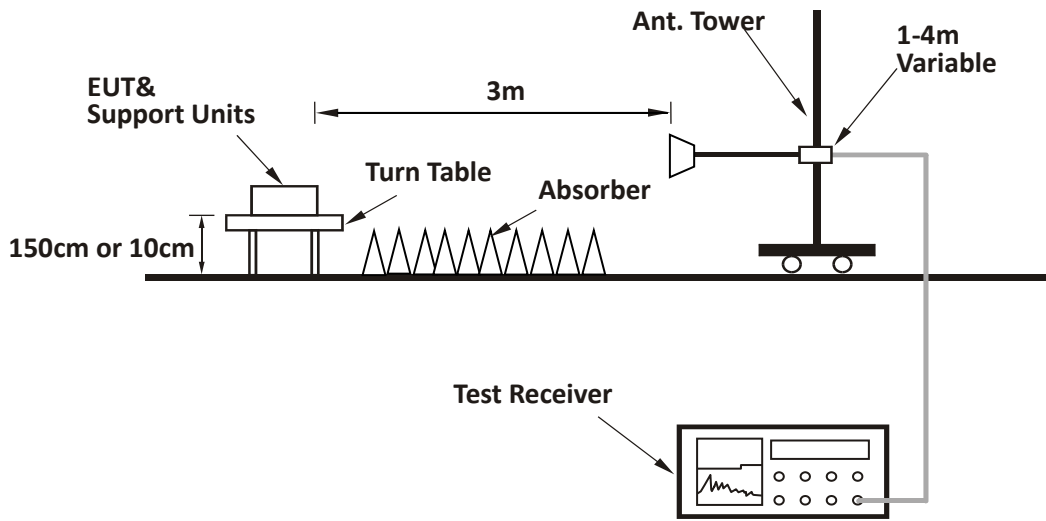

TEST REPORT

7.4 Test Results of Radiated Emissions

The low frequency, which started from 9 kHz to 30MHz, was pre-scanned and the result which was 20dB lower than the limit line per 15.31(o) was not reported.

Horizontal

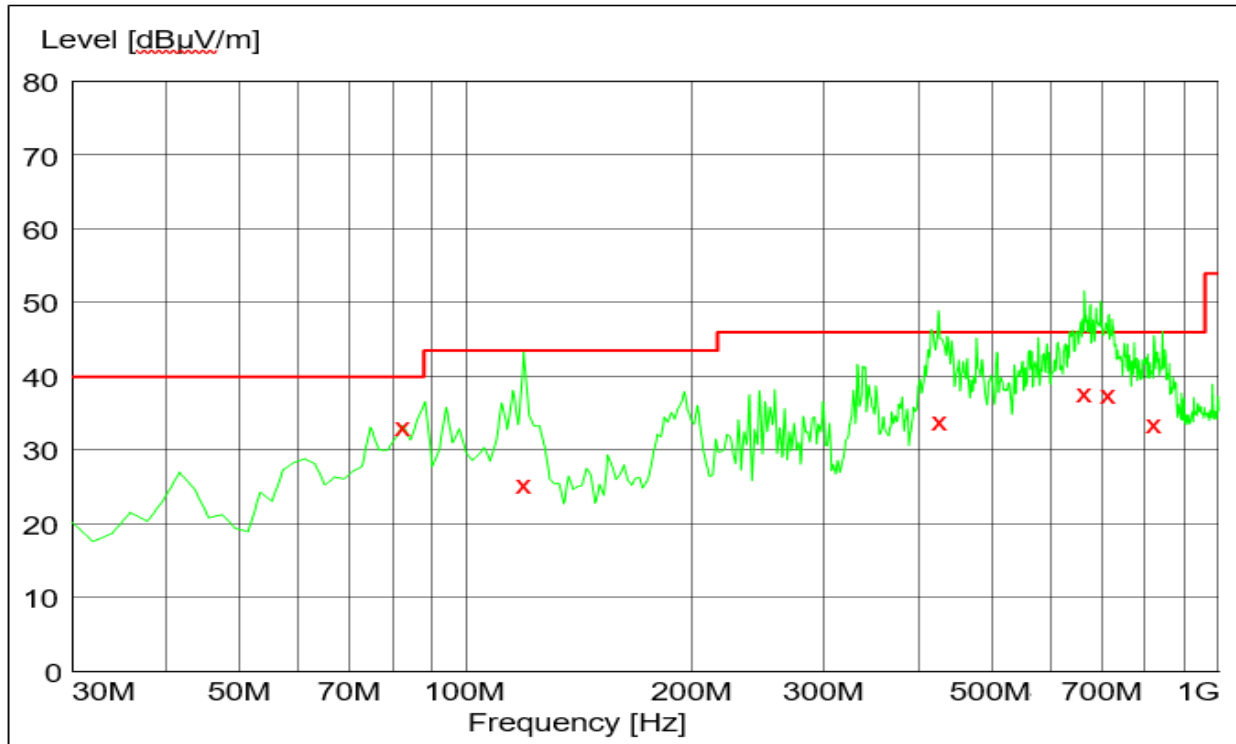

Vertical

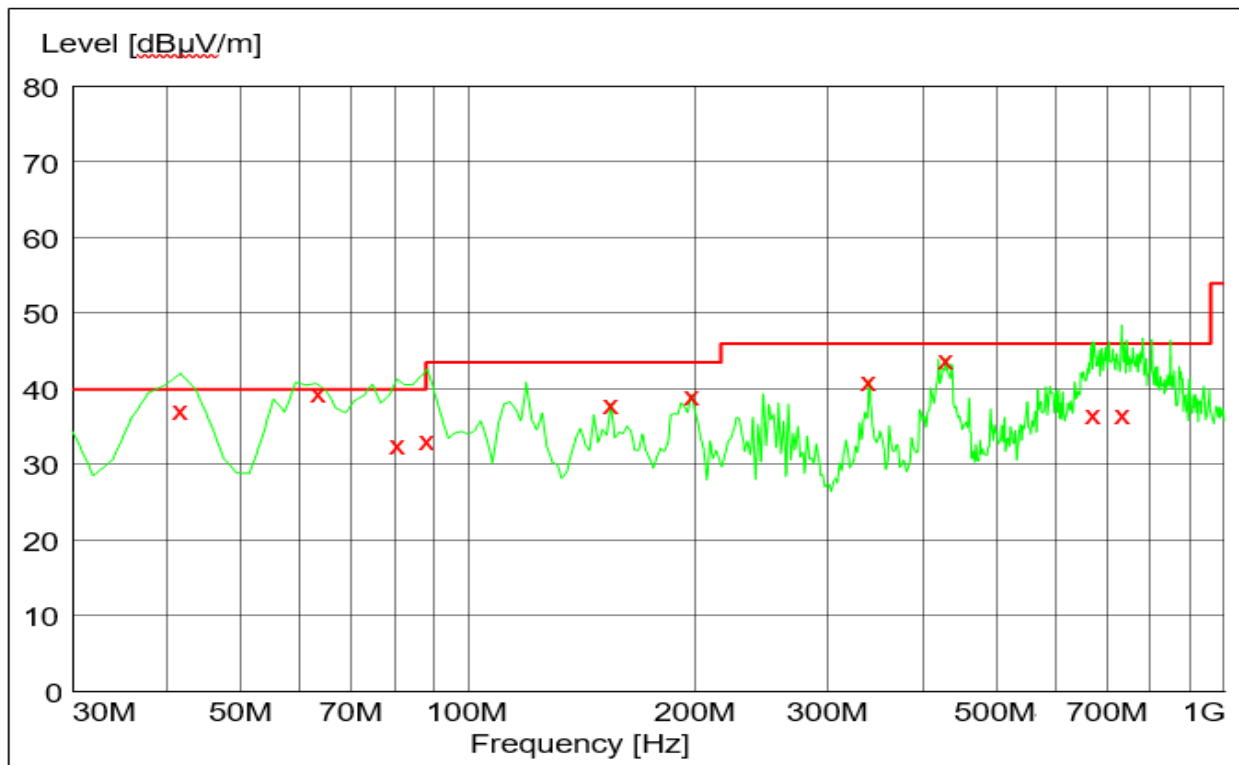

TEST REPORT

Test data below 1GHz

Antenna	Frequency (MHz)	Corrected Reading (dBuV/m)	Limit (dBuV/m)	Margin (dB)	Detector
H	82.48	33.40	40.00	6.60	PK
H	119.42	25.40	43.50	18.10	QP
H	424.61	34.10	46.00	11.90	QP
H	663.71	37.90	46.00	8.10	QP
H	714.25	37.70	46.00	8.30	QP
H	821.16	33.60	46.00	12.40	QP
V	41.66	37.30	40.00	2.70	QP
V	63.51	39.60	40.00	0.40	QP
V	80.54	32.80	40.00	7.20	QP
V	87.90	33.40	40.00	6.60	QP
V	671.48	36.80	46.00	9.20	QP
V	731.74	36.70	46.00	9.30	QP

Test result above 1GHz:

The emission was conducted from 1GHz to 25GHz

802.11b

CH	Antenna	Frequency (MHz)	Corrected Reading (dBuV/m)	Limit (dBuV/m)	Margin (dB)	Detector
L	H	2390.00	50.30	74.00	23.70	PK
	V	2390.00	51.10	74.00	22.90	PK
	V	4824.00	49.80	74.00	24.20	PK
M	V	4874.00	50.10	74.00	23.90	PK
H	H	2483.50	50.70	74.00	23.30	PK
	V	2483.50	51.40	74.00	22.60	PK
	V	4924.00	50.50	74.00	23.50	PK

802.11g

CH	Antenna	Frequency (MHz)	Corrected Reading (dBuV/m)	Limit (dBuV/m)	Margin (dB)	Detector
L	V	2390.00	51.40	74.00	22.60	PK
	V	4824.00	50.20	74.00	23.80	PK
M	V	4874.00	50.50	74.00	23.50	PK

TEST REPORT

H	V	2483.50	51.70	74.00	22.30	PK
	V	4924.00	50.80	74.00	23.20	PK

TEST REPORT

802.11n(HT20)

CH	Antenna	Frequency (MHz)	Corrected Reading (dBuV/m)	Limit (dBuV/m)	Margin (dB)	Detector
	V	2390.00	55.30	74.00	18.70	PK
	V	2390.00	48.70	54.00	5.30	AV
	V	4824.00	50.10	74.00	23.90	PK
M	V	4874.00	50.40	74.00	23.60	PK
H	V	2483.50	56.60	74.00	17.40	PK
	V	2483.50	49.80	54.00	4.20	AV
	V	4924.00	50.90	74.00	23.10	PK

802.11n(HT40)

CH	Antenna	Frequency (MHz)	Corrected Reading (dBuV/m)	Limit (dBuV/m)	Margin (dB)	Detector
	V	2390.00	57.30	74.00	16.70	PK
	V	2390.00	50.70	54.00	3.30	AV
	V	4844.00	50.40	74.00	23.60	PK
M	V	4874.00	50.70	74.00	23.30	PK
H	V	2483.50	59.20	74.00	14.80	PK
	V	2483.50	51.80	54.00	2.20	AV
	V	4904.00	50.90	74.00	23.10	PK

- Remark: 1. Correct Factor = Antenna Factor + Cable Loss (+ Amplifier, for higher than 1GHz), the value was added to Original Receiver Reading by the software automatically.
 2. Corrected Reading = Original Receiver Reading + Correct Factor
 3. Margin = Limit - Corrected Reading
 4. If the PK Corrected Reading is lower than AV limit, the AV test can be elided.

Example: Assuming Antenna Factor = 30.20dB/m, Cable Loss = 2.00dB,
 Gain of Preamplifier = 32.00dB, Original Receiver Reading = 10.00dBuV,
 Limit = 40.00dBuV/m.
 Then Correct Factor = 30.20 + 2.00 – 32.00 = 0.20dB/m;
 Corrected Reading = 10dBuV + 0.20dB/m = 10.20dBuV/m;
 Margin = 40.00dBuV/m - 10.20dBuV/m = 29.80dB.

TEST REPORT

8 Power line conducted emission

Test result: Pass

8.1 Limit

Frequency of Emission (MHz)	Conducted Limit (dBuV)	
	QP	AV
0.15-0.5	66 to 56*	56 to 46 *
0.5-5	56	46
5-30	60	50

* Decreases with the logarithm of the frequency.

8.2 Test Configuration

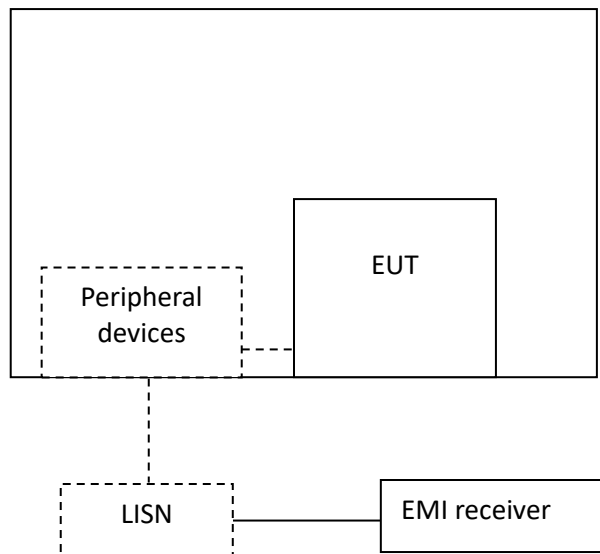

TEST REPORT**8.3 Measurement Procedure**

Measured levels of ac power-line conducted emission shall be the emission voltages from the voltage probe, where permitted, or across the 50 Ω LISN port (to which the EUT is connected), where permitted, terminated into a 50 Ω measuring instrument. All emission voltage and current measurements shall be made on each current-carrying conductor at the plug end of the EUT power cord by the use of mating plugs and receptacles on the LISN, if used. Equipment shall be tested with power cords that are normally supplied or recommended by the manufacturer and that have electrical and shielding characteristics that are the same as those cords normally supplied or recommended by the manufacturer. For those measurements using a LISN, the 50 Ω measuring port is terminated by a measuring instrument having 50 Ω input impedance. All other ports are terminated in 50 Ω loads.

Tabletop devices shall be placed on a platform of nominal size 1 m by 1.5 m, raised 80 cm above the reference ground plane. The vertical conducting plane or wall of an RF-shielded (screened) room shall be located 40 cm to the rear of the EUT. Floor-standing devices shall be placed either directly on the reference ground-plane or on insulating material as described in ANSI C63.4. All other surfaces of tabletop or floor-standing EUTs shall be at least 80 cm from any other grounded conducting surface, including the case or cases of one or more LISNs.

The bandwidth of the test receiver is set at 9 kHz.

TEST REPORT

8.4 Test Results of Power line conducted emission

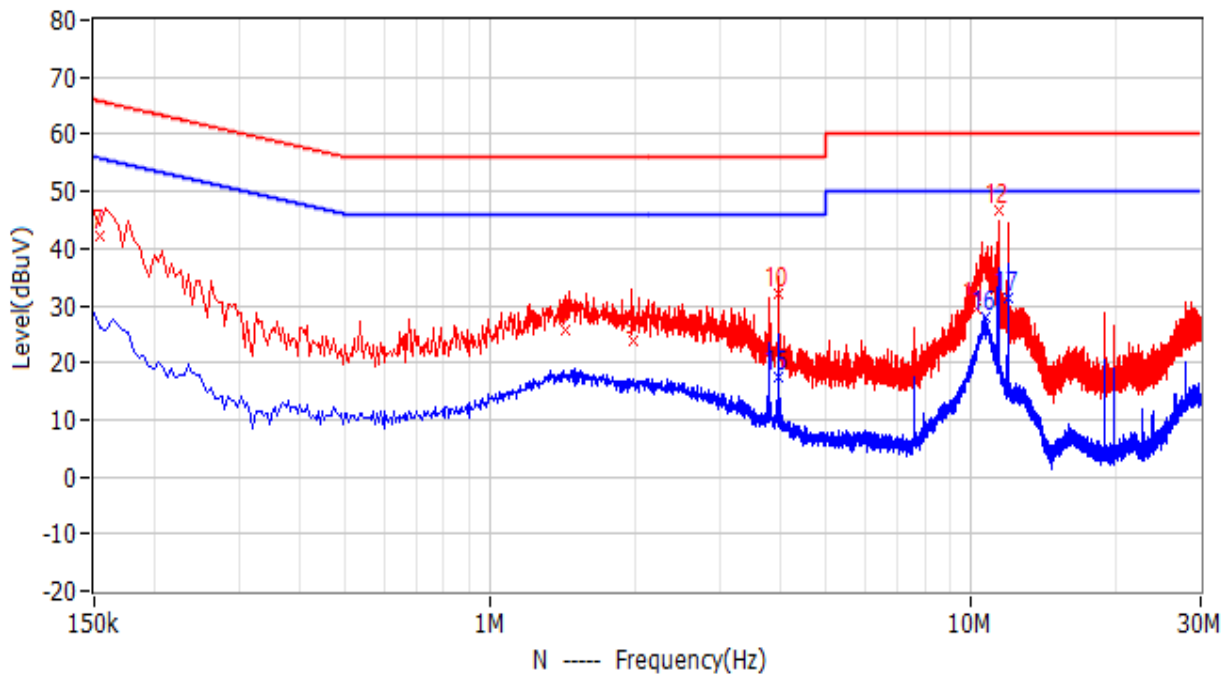
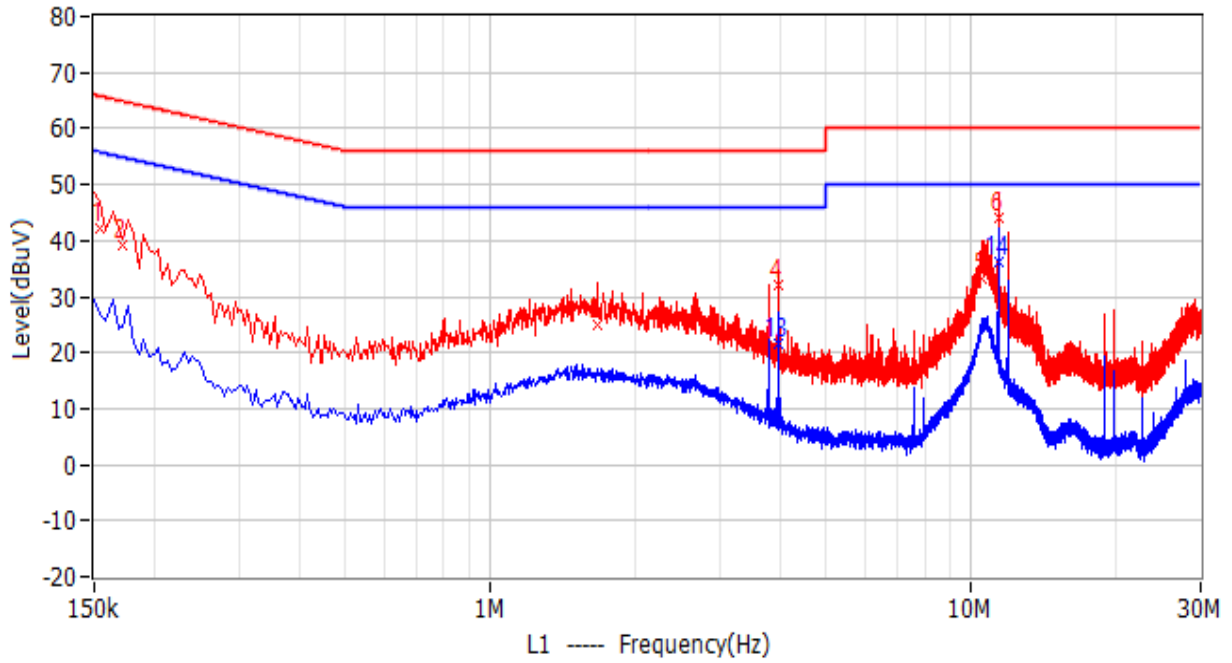

TEST REPORT

No.	Frequency	Limit dBuV	Level dBuV	Delta dB	Reading dBuV	Factor dB	Detector	Phase
1	154.500kHz	65.8	42.0	-23.8	35.8	6.2	QP	L1
2	172.500kHz	64.8	39.2	-25.6	33.1	6.1	QP	L1
3	1.676MHz	56.0	24.8	-31.2	18.6	6.2	QP	L1
4	3.971MHz	56.0	31.9	-24.1	25.6	6.3	QP	L1
5	10.505MHz	60.0	33.3	-26.7	27.0	6.3	QP	L1
6	11.378MHz	60.0	44.1	-15.9	37.7	6.4	QP	L1
7	154.500kHz	65.8	42.1	-23.7	35.8	6.3	QP	N
8	1.437MHz	56.0	25.6	-30.4	19.3	6.3	QP	N
9	1.986MHz	56.0	23.9	-32.1	17.6	6.3	QP	N
10	3.971MHz	56.0	32.1	-23.9	25.8	6.3	QP	N
11	10.266MHz	60.0	29.6	-30.4	23.2	6.4	QP	N
12	11.382MHz	60.0	46.5	-13.5	40.1	6.4	QP	N
13	3.971MHz	46.0	21.4	-24.6	15.1	6.3	CAV	L1
14	11.382MHz	50.0	36.0	-14.0	29.6	6.4	CAV	L1
15	3.966MHz	46.0	17.3	-28.7	11.0	6.3	CAV	N
16	10.716MHz	50.0	27.8	-22.2	21.4	6.4	CAV	N
17	11.918MHz	50.0	31.2	-18.8	24.8	6.4	CAV	N

- Remark: 1. Correct Factor = LISN Factor + Cable Loss, the value was added to Original Receiver Reading by the software automatically.*
- 2. Level = Reading + Correct Factor*
- 3. Delta= Level - Limit*
- 4. If the PK Corrected Reading is lower than AV limit, the AV test can be elided.*

TEST REPORT**9 Occupied Bandwidth****Test result:** **Tested****9.1 Limit**

None

9.2 Measurement Procedure

The occupied bandwidth per RSS-Gen Issue 4 Clause 6.6 was measured using the Spectrum Analyzer.

The span of the analyzer shall be set to capture all products of the modulation process, including the emission skirts.

The resolution bandwidth (RBW) shall be in the range of 1% to 5% of the occupied bandwidth (OBW) and video bandwidth (VBW) shall be approximately 3x RBW.

9.3 Test Configuration**9.4 The results of Occupied Bandwidth**

Please refer to Appendix A

TEST REPORT**10 Antenna requirement****Requirement:**

An intentional radiator shall be designed to ensure that no antenna other than that furnished by the responsible party shall be used with the device. The use of a permanently attached antenna or of an antenna that uses a unique coupling to the intentional radiator shall be considered sufficient to comply with the provisions of this section.

Result:

EUT uses permanently attached antenna to the intentional radiator, so it can comply with the provisions of this section.

TEST REPORT

Appendix A: Test results

1. Duty Cycle

1.1 Test Data

WLAN Duty Cycle				
Mode	Test Frequency (MHz)	Ant	Duty Cycle (%)	Duty Cycle Factor (dB)
802.11b	2412	Ant0	100.00	0.00
802.11b	2437	Ant0	100.00	0.00
802.11b	2462	Ant0	100.00	0.00
802.11g	2412	Ant0	99.52	0.00
802.11g	2437	Ant0	99.52	0.00
802.11g	2462	Ant0	99.52	0.00
802.11n (HT20)	2412	Ant0	99.48	0.00
802.11n (HT20)	2437	Ant0	99.48	0.00
802.11n (HT20)	2462	Ant0	99.48	0.00
802.11n (HT40)	2422	Ant0	98.93	0.00
802.11n (HT40)	2437	Ant0	98.93	0.00
802.11n (HT40)	2452	Ant0	98.93	0.00

TEST REPORT

1.2 Test Plots

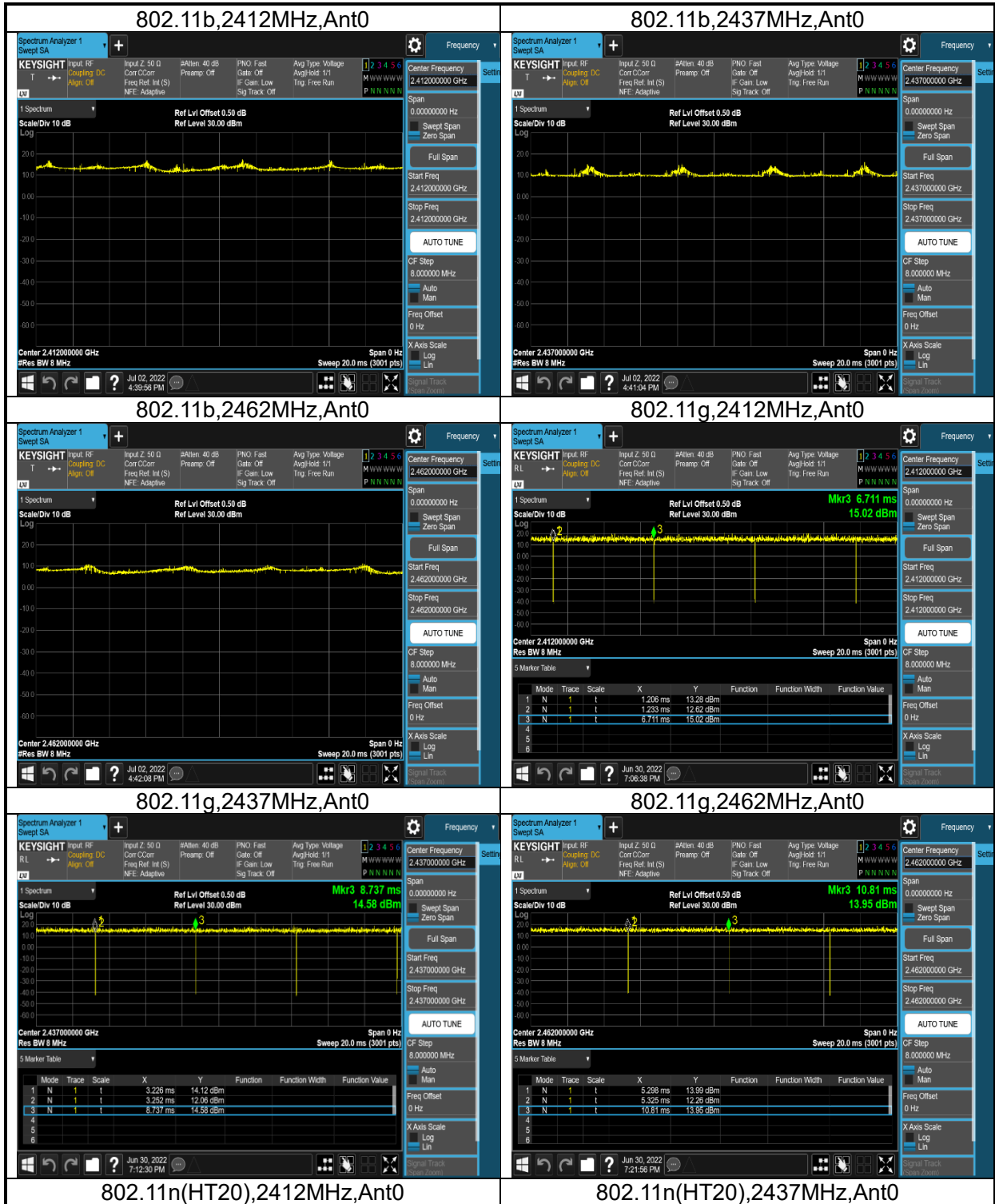

TEST REPORT

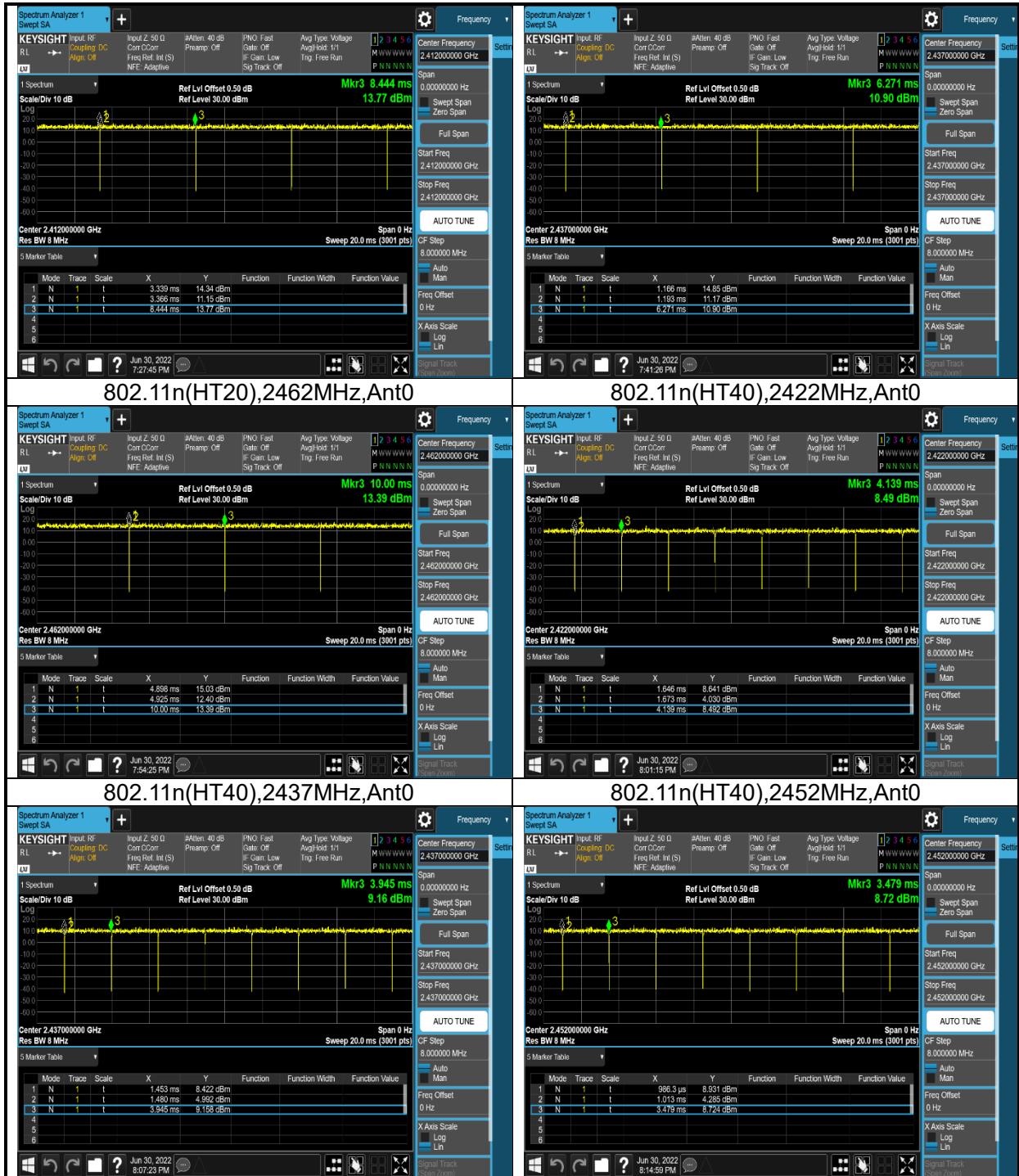

TEST REPORT

2. Minimum 6dB bandwidth

2.1 Test Data

WLAN Occupied 6dB Bandwidth				
Mode	Test Frequency (MHz)	Ant	Occupied Bandwidth (MHz)	Result
802.11b	2412	Ant0	8.69	Pass
802.11b	2437	Ant0	9.58	Pass
802.11b	2462	Ant0	8.67	Pass
802.11g	2412	Ant0	16.40	Pass
802.11g	2437	Ant0	16.38	Pass
802.11g	2462	Ant0	16.39	Pass
802.11n (HT20)	2412	Ant0	17.62	Pass
802.11n (HT20)	2437	Ant0	17.64	Pass
802.11n (HT20)	2462	Ant0	17.64	Pass
802.11n (HT40)	2422	Ant0	32.68	Pass
802.11n (HT40)	2437	Ant0	32.70	Pass
802.11n (HT40)	2452	Ant0	32.65	Pass

TEST REPORT

2.2 Test Plots

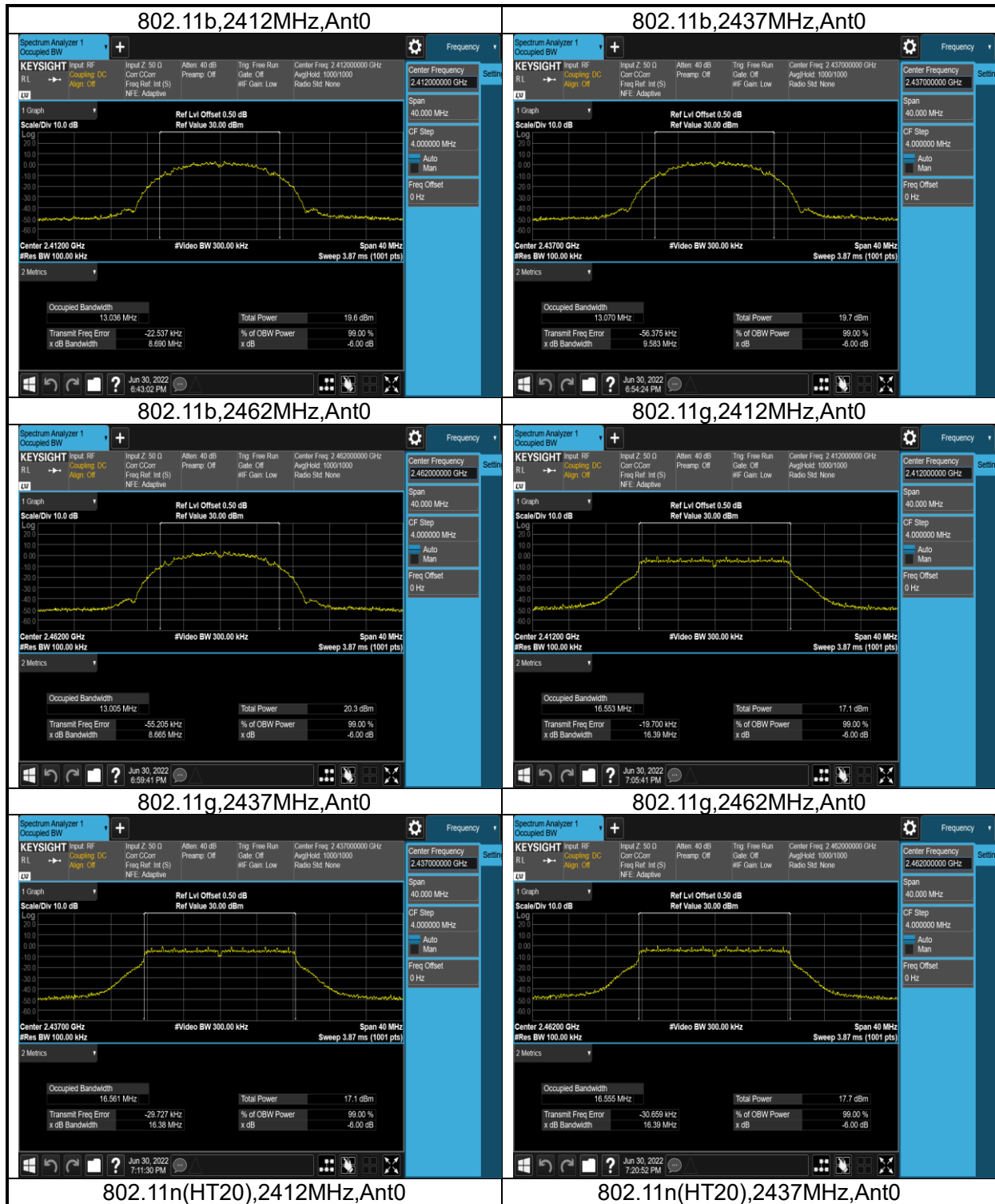

TEST REPORT

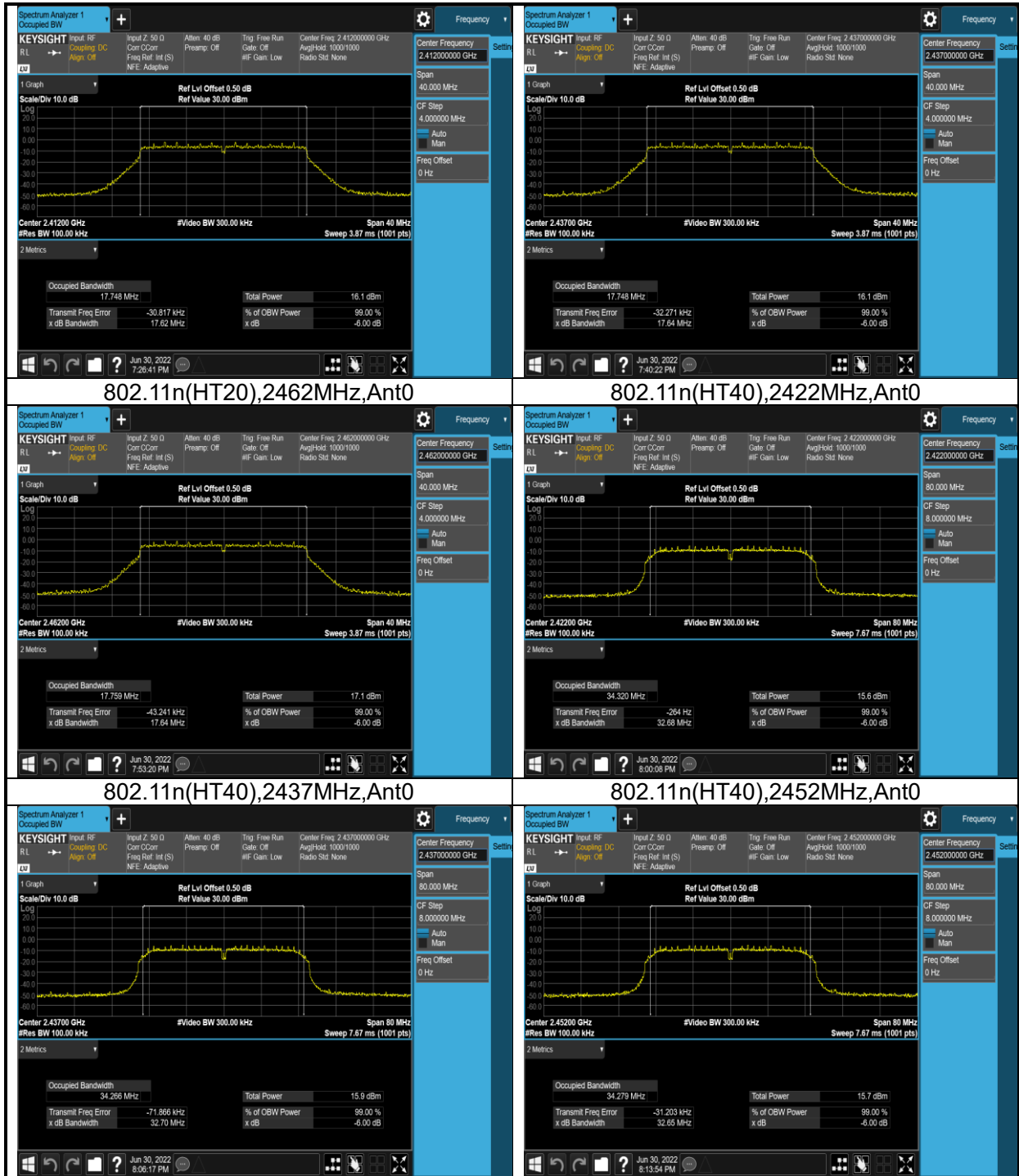

TEST REPORT

3. Occupied Bandwidth

3.1 Test Data

WLAN 99% Occupied Bandwidth				
Mode	Test Frequency (MHz)	Ant	99% Occupied Bandwidth (MHz)	Result
802.11b	2412	Ant0	13.076	Pass
802.11b	2437	Ant0	13.091	Pass
802.11b	2462	Ant0	13.065	Pass
802.11g	2412	Ant0	17.201	Pass
802.11g	2437	Ant0	17.230	Pass
802.11g	2462	Ant0	17.212	Pass
802.11n (HT20)	2412	Ant0	18.179	Pass
802.11n (HT20)	2437	Ant0	18.140	Pass
802.11n (HT20)	2462	Ant0	18.151	Pass
802.11n (HT40)	2422	Ant0	34.353	Pass
802.11n (HT40)	2437	Ant0	34.331	Pass
802.11n (HT40)	2452	Ant0	34.317	Pass

TEST REPORT

3.2 Test Plots

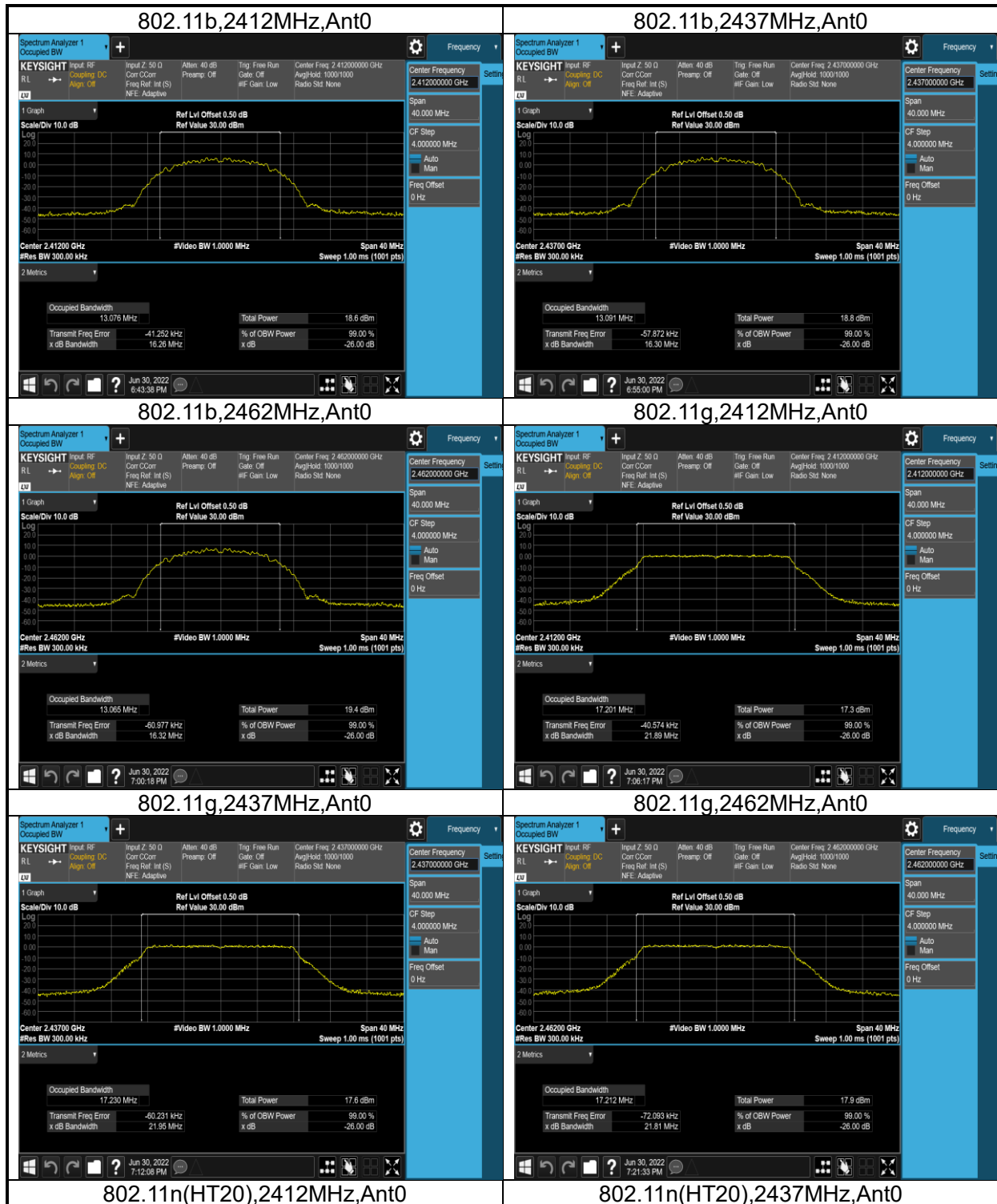

TEST REPORT

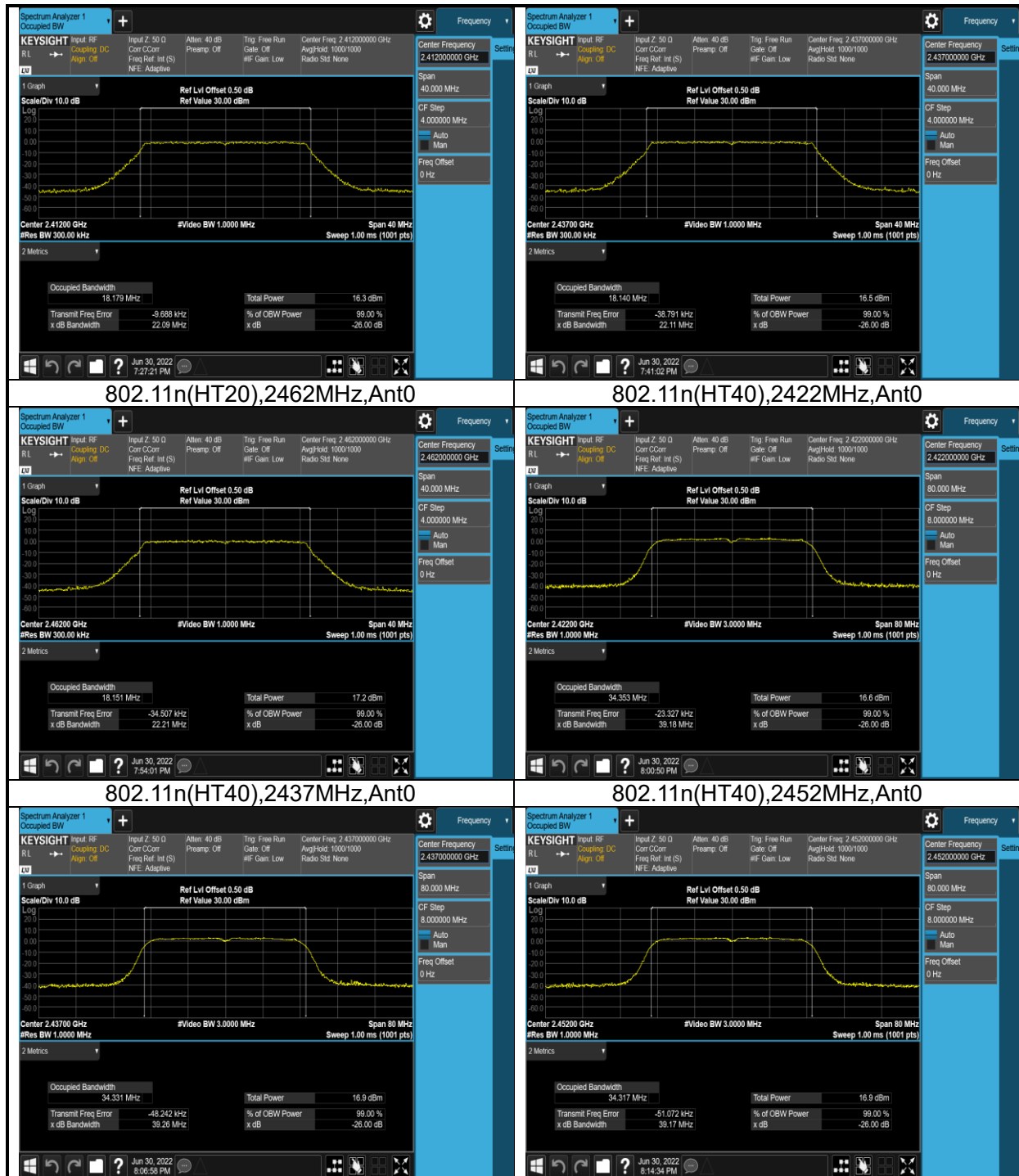

TEST REPORT

4. Maximum conducted output power and e.i.r.p

4.1 Test Data

WLAN AVGSA Output Power							
Mode	Test Frequency (MHz)	Ant	Duty Cycle Factor (dB)	Max Power (dBm)	Limit (dBm)	EIRP (dBm)	Result
802.11b	2412	Ant0	0.00	16.89	30	18.89	Pass
802.11b	2437	Ant0	0.00	17.23	30	19.23	Pass
802.11b	2462	Ant0	0.00	17.84	30	19.84	Pass
802.11g	2412	Ant0	0.00	15.42	30	17.42	Pass
802.11g	2437	Ant0	0.00	15.74	30	17.74	Pass
802.11g	2462	Ant0	0.00	15.99	30	17.99	Pass
802.11n (HT20)	2412	Ant0	0.00	14.44	30	16.44	Pass
802.11n (HT20)	2437	Ant0	0.00	14.61	30	16.61	Pass
802.11n (HT20)	2462	Ant0	0.00	15.36	30	17.36	Pass
802.11n (HT40)	2422	Ant0	0.00	13.04	30	15.04	Pass
802.11n (HT40)	2437	Ant0	0.00	13.30	30	15.30	Pass
802.11n (HT40)	2452	Ant0	0.00	13.38	30	15.38	Pass

TEST REPORT

4.2 Test Plots

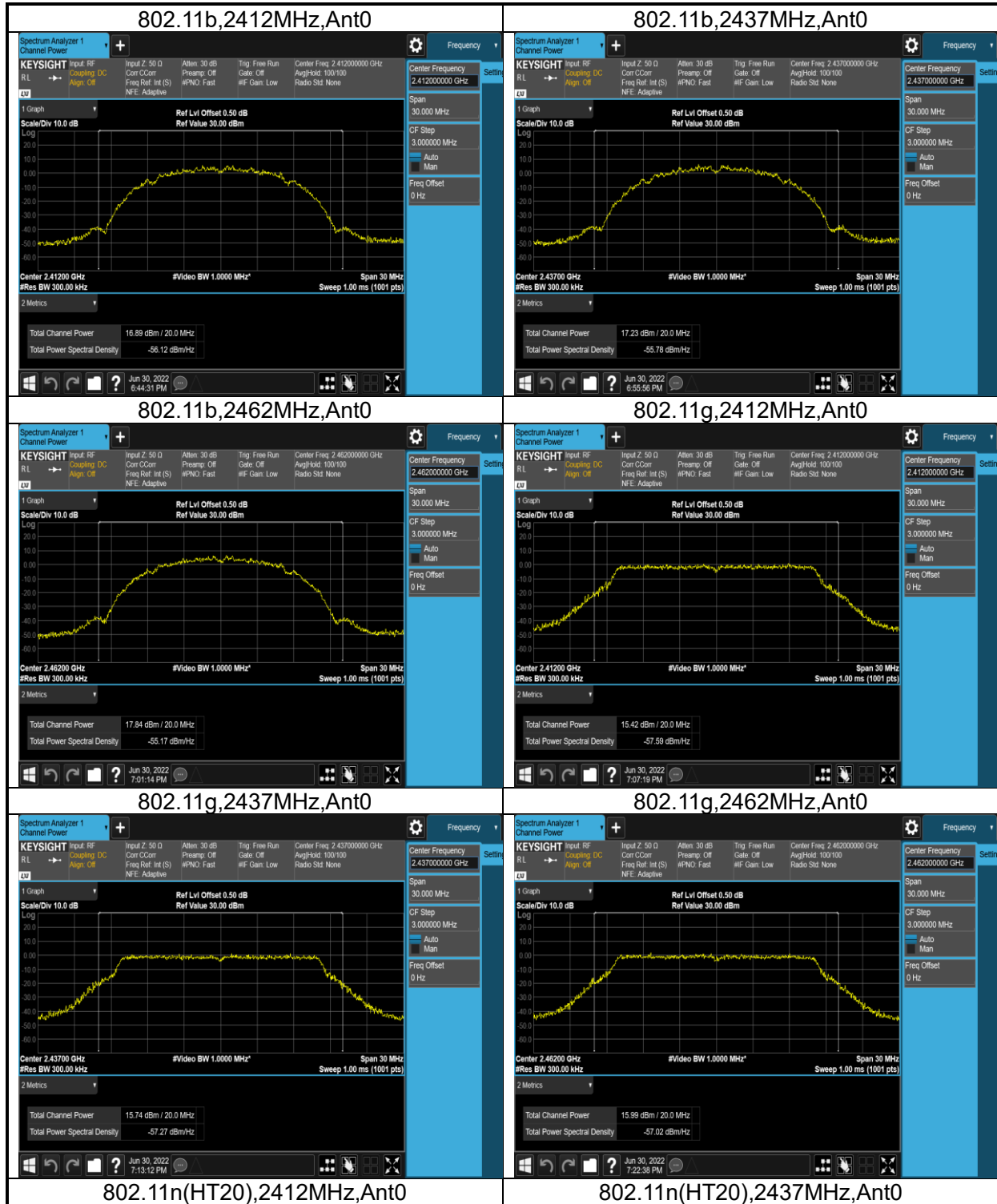

TEST REPORT

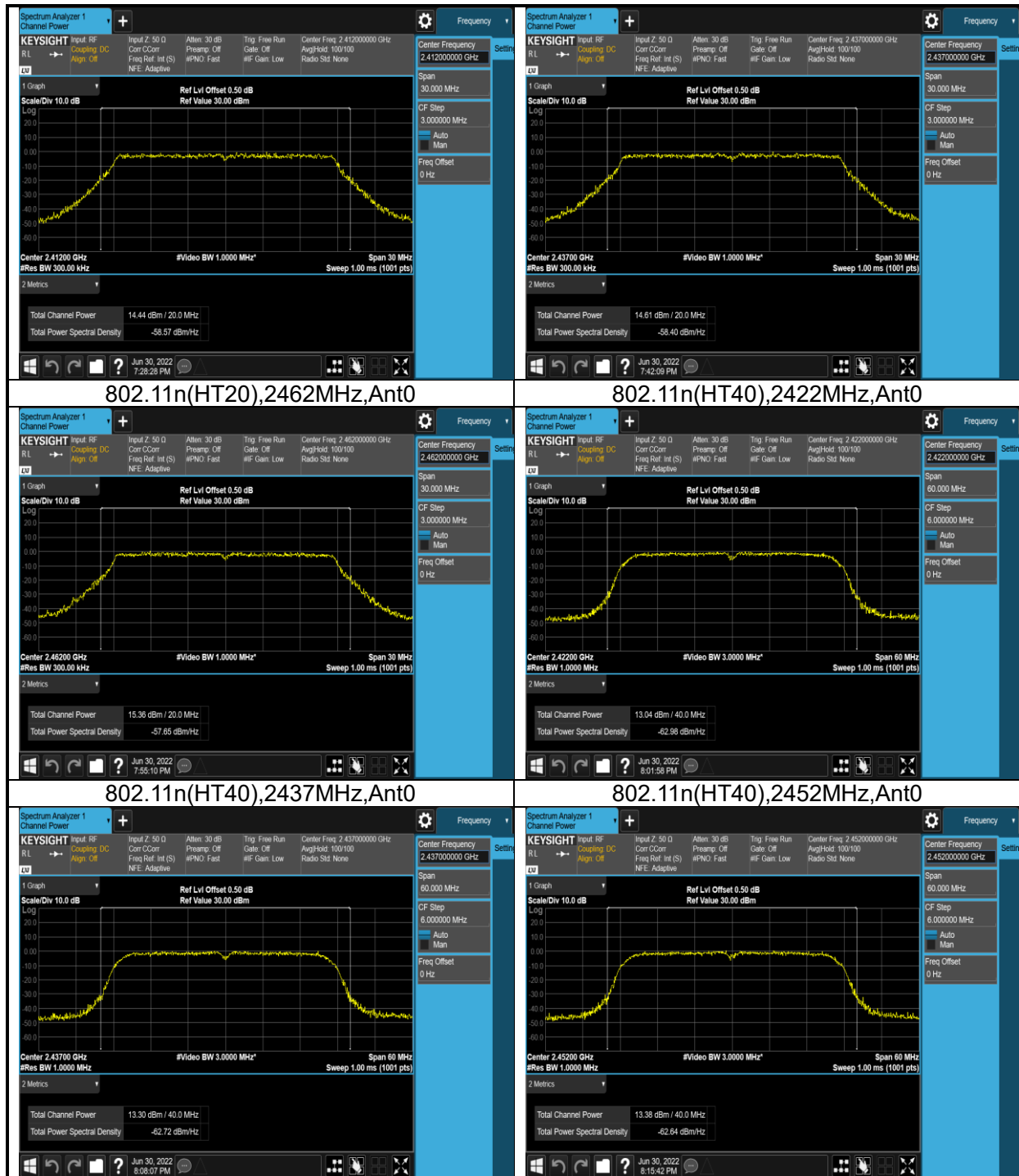

802.11n(HT20),2462MHz,Ant0

802.11n(HT40),2422MHz,Ant0

802.11n(HT40),2437MHz,Ant0

802.11n(HT40),2452MHz,Ant0

TEST REPORT

5. Power spectrum density

5.1 Test Data

WLAN AVGSA Power Spectral Density							
Mode	Test Frequency (MHz)	Ant	Duty Cycle Factor (dB)	PSD (dBm)	RBW (kHz)	Limit (dBm)	Result
802.11b	2412	Ant0	0.00	-21.520	3	8	Pass
802.11b	2437	Ant0	0.00	-21.318	3	8	Pass
802.11b	2462	Ant0	0.00	-21.073	3	8	Pass
802.11g	2412	Ant0	0.00	-24.757	3	8	Pass
802.11g	2437	Ant0	0.00	-24.093	3	8	Pass
802.11g	2462	Ant0	0.00	-23.910	3	8	Pass
802.11n (HT20)	2412	Ant0	0.00	-25.934	3	8	Pass
802.11n (HT20)	2437	Ant0	0.00	-24.919	3	8	Pass
802.11n (HT20)	2462	Ant0	0.00	-24.729	3	8	Pass
802.11n (HT40)	2422	Ant0	0.00	-28.375	3	8	Pass
802.11n (HT40)	2437	Ant0	0.00	-28.415	3	8	Pass
802.11n (HT40)	2452	Ant0	0.00	-27.534	3	8	Pass

TEST REPORT

5.2 Test Plots

