

FCC TEST REPORT

For

American Exchange Time LLC

Playzoom Walkie Talkie

Test Model: 9000211

Additional Model No.: 9000210,9000212

Prepared for : American Exchange Time LLC
Address : No.1441 Broadway 27th Floor, New York, NY 10018,United States

Prepared by : Shenzhen LCS Compliance Testing Laboratory Ltd.
Address : 101, 201 Bldg A & 301 Bldg C, Juji Industrial Park Yabianxueziwei,
Shajing Street, Baoan District, Shenzhen, 518000, China

Tel : (+86)755-82591330
Fax : (+86)755-82591332
Web : www.LCS-cert.com
Mail : webmaster@LCS-cert.com

Date of receipt of test sample : January 06, 2021
Number of tested samples : 2
Serial number : Prototype
Date of Test : January 06, 2021~January 25, 2021
Date of Report : January 25, 2021

FCC TEST REPORT
FCC CFR 47 PART 95

Report Reference No. : LCS210104035AEA

Date of Issue : January 25, 2021

Testing Laboratory Name : Shenzhen LCS Compliance Testing Laboratory Ltd.

Address : 101, 201 Bldg A & 301 Bldg C, Juji Industrial Park Yabianxueziwei, Shajing Street, Baoan District, Shenzhen, 518000, China

Testing Location/ Procedure : Full application of Harmonised standards [checked]
Partial application of Harmonised standards [unchecked]
Other standard testing method [unchecked]

Applicant's Name : American Exchange Time LLC

Address : No.1441 Broadway 27th Floor, New York, NY 10018,United States

Test Specification

Standard : FCC CFR 47 PART 95

Test Report Form No. : LCSEMC-1.0

TRF Originator : Shenzhen LCS Compliance Testing Laboratory Ltd.

Master TRF : Dated 2011-03

Shenzhen LCS Compliance Testing Laboratory Ltd. All rights reserved.

This publication may be reproduced in whole or in part for non-commercial purposes as long as the Shenzhen LCS Compliance Testing Laboratory Ltd. is acknowledged as copyright owner and source of the material. Shenzhen LCS Compliance Testing Laboratory Ltd. takes no responsibility for and will not assume liability for damages resulting from the reader's interpretation of the reproduced material due to its placement and context.

EUT Description : Playzoom Walkie Talkie

Trade Mark : playzoom

Test Model : 9000211

Ratings : DC 4.5V By Battery

Result : Positive

Compiled by:

Supervised by:

Approved by:

Handwritten signature of Jack Liu

Handwritten signature of Jin Wang

Handwritten signature of Gavin Liang

Jack Liu/ Administrators

Jin Wang/ Technique principal

Gavin Liang/ Manager

FCC -- TEST REPORT

Test Report No. : LCS210104035AEA	January 25, 2021 Date of issue
--	-----------------------------------

Test Model.....	: 9000211
EUT.....	: Playzoom Walkie Talkie
Applicant.....	: American Exchange Time LLC
Address.....	: No.1441 Broadway 27th Floor, New York, NY 10018,United States
Telephone.....	: /
Fax.....	: /
Manufacturer.....	: Shantou Jinying Yibu Toys Co., Ltd
Address.....	: Dongqianxi Village Industrial Zone, Lianxia Town, Chenghai District, Shantou City,Guangdong, China.
Telephone.....	: /
Fax.....	: /
Factory.....	: /
Address.....	: /
Telephone.....	: /
Fax.....	: /

Test Result	Positive
--------------------	-----------------

The test report merely corresponds to the test sample.

It is not permitted to copy extracts of these test result without the written permission of the test laboratory.

Revision History

Revision	Issue Date	Revisions	Revised By
000	January 25, 2021	Initial Issue	Gavin Liang

TABLE OF CONTENTS

Description.....	Page
1. GENERAL INFORMATION.....	6
1.1. DESCRIPTION OF DEVICE (EUT).....	6
1.2. HOST SYSTEM CONFIGURATION LIST AND DETAILS.....	6
1.3. EXTERNAL I/O CABLE.....	6
1.4. DESCRIPTION OF TEST FACILITY.....	6
1.5. STATEMENT OF THE MEASUREMENT UNCERTAINTY.....	7
1.6. MEASUREMENT UNCERTAINTY.....	7
1.7. DESCRIPTION OF TEST MODES.....	8
2. TEST METHODOLOGY.....	9
2.1. TEST STANDARDS.....	9
2.2. EUT CONFIGURATION.....	9
2.3. EUT EXERCISE.....	9
2.4. GENERAL TEST PROCEDURES.....	9
2.5. TEST SAMPLE.....	9
3. SYSTEM TEST CONFIGURATION.....	10
3.1. JUSTIFICATION.....	10
3.2. EUT EXERCISE SOFTWARE.....	10
3.3. SPECIAL ACCESSORIES.....	10
3.4. BLOCK DIAGRAM/SCHEMATICS.....	10
3.5. EQUIPMENT MODIFICATIONS.....	10
3.6. TEST SETUP.....	10
4. SUMMARY OF TEST RESULTS.....	11
5. MEASUREMENT RESULTS.....	12
5.1. MAXIMUM TRANSMITTER POWER.....	12
5.2. OCCUPIED BANDWIDTH AND EMISSION MASK.....	14
5.3. MODULATION CHARACTERISTIC.....	16
5.4. FREQUENCY STABILITY.....	19
5.5. TRANSMITTER RADIATED SPURIOUS EMISSION.....	20
6. SUMMARY OF TEST EQUIPMENT.....	22
7. TEST SETUP PHOTOGRAPHS OF EUT.....	23
8. EXTERIOR PHOTOGRAPHS OF THE EUT.....	23
9. INTERIOR PHOTOGRAPHS OF THE EUT.....	23

1. GENERAL INFORMATION

1.1. Description of Device (EUT)

EUT : Playzoom Walkie Talkie
 Test Model : 9000211
 Additional Model No. : 9000210,9000212
 Model Declaration : PCB board, structure and internal of these model(s) are the same, So no additional models were tested.
 Power Supply : DC 4.5V By Battery
 Hardware Version : /
 Software Version : /
 Channel Frequency : 462.5625MHz (0.5W declared by manufacturer)
 Channel Number : 1 channels
 Modulation Type : FM
 Emission Type : F3E
 Rate Power : 0.5W
 (It was fixed by the manufacturer, any individual can't arbitrarily change it.)
 Antenna Description : Spring Antenna, 0.5dBi (Max.)

1.2. Host System Configuration List and Details

Manufacturer	Description	Model	Serial Number	Certificate
--	--	--	--	--

1.3. External I/O Cable

I/O Port Description	Quantity	Cable
--	--	--

1.4. Description of Test Facility

NVLAP Accreditation Code is 600167-0.
 FCC Designation Number is CN5024.
 CAB identifier is CN0071.
 CNAS Registration Number is L4595.

The 3m-Semi anechoic test site fulfils CISPR 16-1-4 according to ANSI C63.4:2014 and CISPR 16-1-4:2010 SVSWR requirement for radiated emission above 1GHz.

1.5. Statement of the Measurement Uncertainty

The data and results referenced in this document are true and accurate. The reader is cautioned that there may be errors within the calibration limits of the equipment and facilities. The measurement uncertainty was calculated for all measurements listed in this test report acc. To CISPR 16 – 4 “Specification for radio disturbance and immunity measuring apparatus and methods – Part 4: Uncertainty in EMC Measurements” and is documented in the LCS quality system acc. To DIN EN ISO/IEC 17025. Furthermore, component and process variability of devices similar to that tested may result in additional deviation. The manufacturer has the sole responsibility of continued compliance of the device.

1.6. Measurement Uncertainty

Test Item	Uncertainty	Note
Frequency error	30 Hz	(1)
Transmitter power conducted	0.62 dB	(1)
Transmitter power Radiated	2.67 dB	(1)
Conducted spurious emission 9KHz-12.75 GHz	1.88 dB	(1)
Conducted Emission 9KHz-30MHz	1.63 dB	(1)
Radiated spurious emission 30~1000MHz	4.65 dB	(1)
Radiated spurious emission 1~18GHz	3.89 dB	(1)
Radiated spurious emission 18-40GHz	3.90 dB	(1)
Occupied Bandwidth	N/A	N/A
Emission Mask	N/A	N/A
Modulation Characteristic	N/A	N/A
Transmitter Frequency Behavior	N/A	N/A

(1). This uncertainty represents an expanded uncertainty expressed at approximately the 95% confidence level using a coverage factor of $k=2$.

1.7. Description of Test Modes

The EUT has been tested under typical operating condition. As, test modes selected as below by the technical parameters of the EUT:

Operation Mode	Modulation	Condition
TM1	FM	TX

Frequency list:

Channel	Frequency(MHz)	Type	Power
1	462.5625	FRS	2.0W

Note1: In section 15.31(m), regards to the operating frequency range less than 1MHz, only one point centered in the frequency range of operation selected to measure.

Note2: The line display in grey was the channel selected for test. The tests for frequencies 462.5625MHz was manufacturer's requirements.

2. TEST METHODOLOGY

2.1. TEST STANDARDS

The tests were performed according to following standards:

[FCC Rules Part 95](#): PERSONAL RADIO SERVICES.

[ANSI/TIA-603-E-2016](#): Land Mobile FM or PM Communications Equipment Measurement and Performance Standards.

[FCC Part 2](#): FREQUENCY ALLOCATIONS AND RADIO TREATY MATTERS; GENERAL RULES AND REGULATIONS

[ANSI C63.26: 2015](#): American National Standard for Compliance Testing of Transmitters Used in Licensed Radio Services

[ANSI C63.4: 2014](#): American National Standard for Methods of Measurement of Radio-Noise Emissions from Low-Voltage Electrical and Electronic Equipment in the Range of 9 kHz to 40GHz

2.2. EUT Configuration

The EUT configuration for testing is installed on RF field strength measurement to meet the Commissions requirement and operating in a manner that intends to maximize its emission characteristics in a continuous normal application.

2.3. EUT Exercise

The EUT has been tested under typical operating condition and The Transmitter was operated in the normal operating mode. The TX frequency was fixed which was for the purpose of the measurements.

2.4. General Test Procedures

2.4.1 Conducted Emissions

N/A

2.4.2 Radiated Emissions

The EUT is placed on a turntable, which is directly placed on the ground. The turntable shall rotate 360 degrees to determine the position of maximum emission level. EUT is set 3m away from the receiving antenna, which varied from 1m to 4m to find out the highest emission. And also, each emission was to be maximized by changing the polarization of receiving antenna both horizontal and vertical. In order to find out the maximum emissions, exploratory radiated emission measurements were made according to the requirements in Section 6.3 of ANSI C63.10-2013

2.5. Test Sample

The application provides 1 samples to meet requirement;

Sample Number	Description
Sample 1	continuous transmit

3. SYSTEM TEST CONFIGURATION

3.1. Justification

The system was configured for testing in a continuous transmits condition.

3.2. EUT Exercise Software

N/ A

3.3. Special Accessories

N/ A

3.4. Block Diagram/Schematics

Please refer to the related document

3.5. Equipment Modifications

Shenzhen LCS Compliance Testing Laboratory Ltd. has not done any modification on the EUT.

3.6. Test Setup

Please refer to the test setup photo.

4. SUMMARY OF TEST RESULTS

Applied Standard: FCC Part 95				
FCC Rules	Description of Test	Test Sample	Result	Remark
FCC Part 2.1046 FCC Part 95.567	Maximum Transmitter Power	Sample 1	Compliant	Note 1
FCC Part 2.1047 FCC Part 95.575	Modulation Characteristic	Sample 1	Compliant	Note 1
FCC Part 2.1049 FCC Part 95.573 FCC Part 95.579	Occupied Bandwidth and Emission Mask	Sample 1	Compliant	Note 1
FCC Part 2.1053 FCC Part 95.579	Radiated Spurious Emission	Sample 1	Compliant	Note 1
FCC Part 2.1055 (d) FCC Part 95.565	Frequency Stability	Sample 1	Compliant	Note 1
FCC Part 2.1093	RF Exposure	Sample 1	Compliant	Note 2

Remark:

1. Note 1 – Test results inside test report;
2. Note 2 – Test results in other test report (SAR Report);

5. MEASUREMENT RESULTS

5.1. Maximum Transmitter Power

5.1.1 Block Diagram of Test Setup

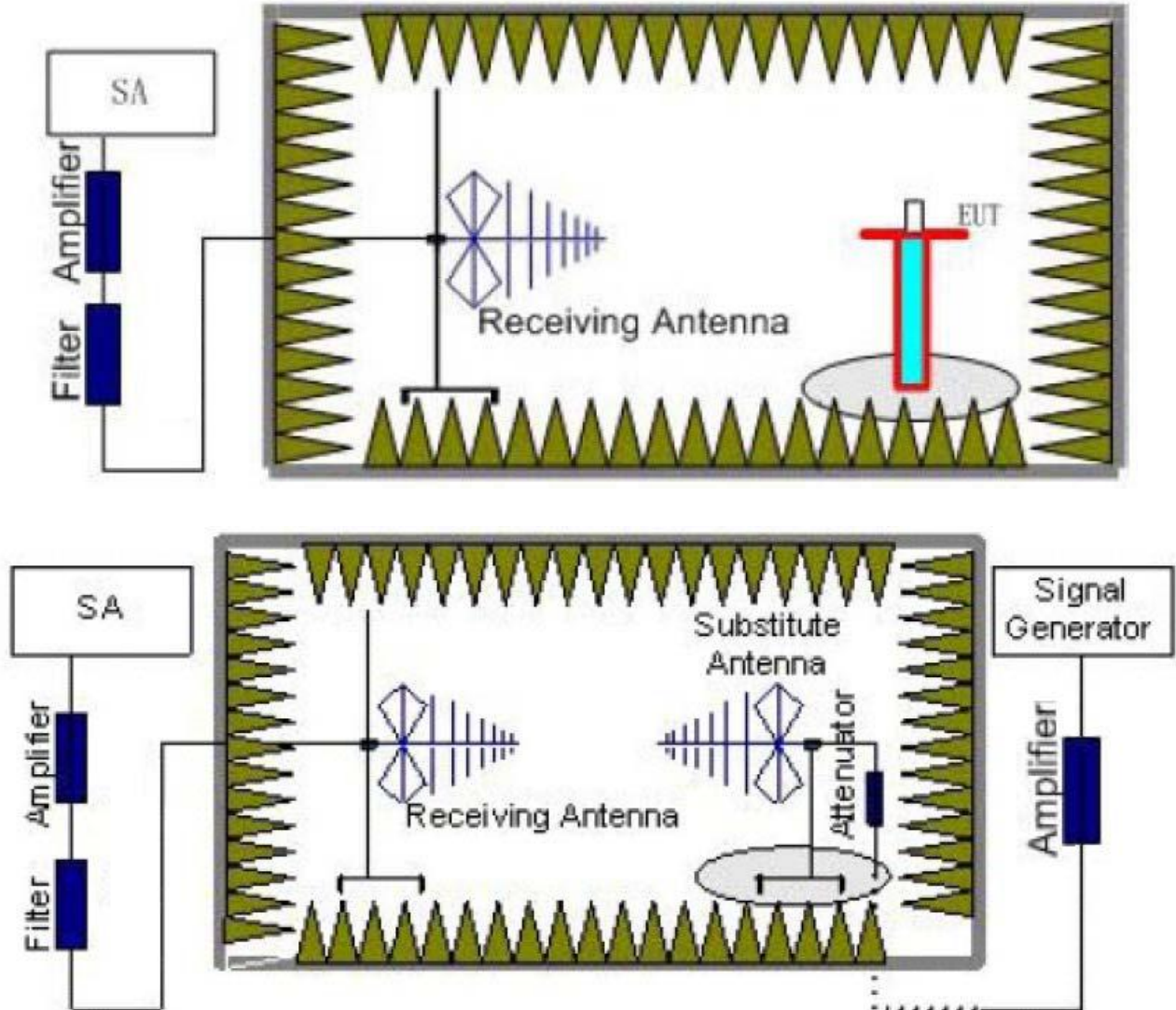

5.1.2 Limit

According to FCC Part 95.567:

Each FRS transmitter type must be designed such that the effective radiated power (ERP) on channels 8 through 14 does not exceed 0.5 Watts and the ERP on channels 1 through 7 and 15 through 22 does not exceed 2.0 Watts.

5.1.3 Test Procedure

1. EUT was placed on a 1.5meter high non-conductive stand at a 3 meter test distance from the receive antenna. A receiving antenna was placed on the antenna mast 3 meters from the EUT for emission measurements. The height of receiving antenna is 1.5m. Detected emissions were maximized at each frequency by rotating the EUT through 360° and adjusting the receiving antenna polarization. The radiated emission measurements of all test transmit frequencies were measured with peak detector.
2. A log-periodic antenna or double-ridged waveguide horn antenna shall be substituted in place of the EUT. The log-periodic antenna will be driven by a signal generator and the level will be adjusted till the same power value on the spectrum analyzer or receiver. The level of the spurious emissions can be calculated through the level of the signal generator, cable loss, the gain of the substitution antenna and the reading of the spectrum analyzer or receiver.
3. The EUT is then put into continuously transmitting mode at its maximum power level during the test. Set Test

Receiver or Spectrum RBW=1MHz, VBW=3MHz, and the maximum value of the receiver should be recorded as (P_r).

4. The EUT shall be replaced by a substitution antenna. In the chamber, a substitution antenna for the frequency band of interest is placed at the reference point of the chamber. An RF Signal source for the frequency band of interest is connected to the substitution antenna with a cable that has been constructed to not interfere with the radiation pattern of the antenna. A power (P_{Mea}) is applied to the input of the substitution antenna, and adjust the level of the signal generator output until the value of the receiver reach the previously recorded (P_r). The power of signal source (P_{Mea}) is recorded. The test should be performed by rotating the test item and adjusting the receiving antenna polarization.
5. An amplifier may be connected to the Signal Source output port. And the cable should be connect between the Amplifier and the Substitution Antenna. The cable loss (P_{cl}), the Substitution Antenna Gain (G_a) and the Amplifier Gain (P_{Ag}) should be recorded after test.
The measurement results are obtained as described below:
Power (EIRP) = $P_{Mea} + P_{Ag} - P_{cl} + G_a$
6. This value is EIRP since the measurement is calibrated using an antenna of known gain (2.15dBi) and known input power.
7. ERP can be calculated from EIRP by subtracting the gain of the dipole, $ERP = EIRP - 2.15dBi$.

5.1.4 Test Results

Temperature	23.3°C	Humidity	53.4%
Test Engineer	Diamond Lu	Test Voltage	Normal Voltage

Test Frequency (MHz)	P_{Mea} (dBm)	P_{cl} (dB)	G_a Antenna Gain (dBi)	Correction (dB)	P_{Ag} (dB)	ERP (dBm)	ERP (W)	Polarization	Limit (W)
462.5625	-11.31	2.08	7.69	2.15	34.59	26.74	0.4721	V	2.0
462.5625	-11.24	2.08	7.69	2.15	34.59	26.81	0.4797	H	2.0

Remark:

1. $EIRP = P_{Mea}(dBm) + P_{Ag}(dB) - P_{cl}(dB) + G_a(dBi)$
2. $ERP = EIRP - 2.15dBi$ as EIRP by subtracting the gain of the dipole.
3. The field strength of radiation emission was measured in the following position: EUT stand-up position (Z axis), lie-down position (X, Y axis). The data show in this report only with the worst case setup. After exploratory measurement the worst case of Z axis and receiver antenna at vertical polarization was reported.

5.2. Occupied Bandwidth and Emission Mask

5.2.1 Limit

According to FCC 95.573:

Each FRS transmitter type must be designed such that the occupied bandwidth does not exceed 12.5kHz.

According to FCC 95.579:

Attenuation requirements. The power of unwanted emissions must be attenuated below the carrier power output in Watts (P) by at least:

- (1) 25 dB (decibels) in the frequency band 6.25 kHz to 12.5 kHz removed from the channel center frequency.
- (2) 35 dB in the frequency band 12.5 kHz to 31.25 kHz removed from the channel center frequency.
- (3) $43 + 10 \log (P)$ dB in any frequency band removed from the channel center frequency by more than 31.25 kHz.

5.2.2 Block Diagram of Test Setup

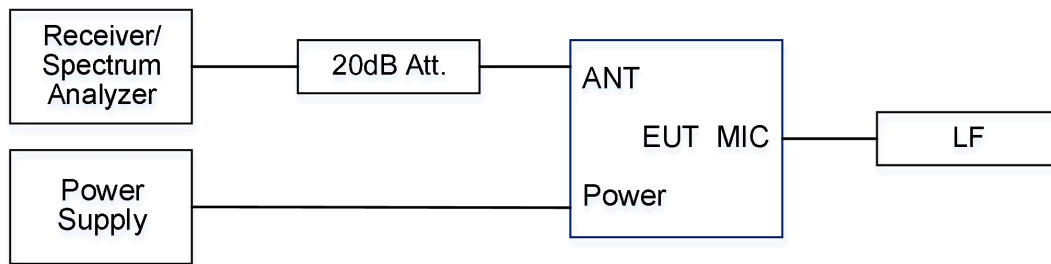

5.2.3 Test Procedure

1. The EUT was modulated by 2.5 KHz Sine wave audio signal; the level of the audio signal employed is 16 dB greater than that necessary to produce 50% of rated system deviation. Rated system deviation is 2.5 kHz (12.5 kHz channel spacing) and 5 kHz (25 kHz channel spacing).
2. Set SPA Center Frequency = fundamental frequency, RBW=300Hz, VBW= 3 KHz, span =50 KHz.
3. Set SPA Max hold. Mark peak, Set 99% Occupied Bandwidth and 26dB Occupied Bandwidth.

5.2.4 Test Results

Temperature	23.3°C	Humidity	53.4%
Test Engineer	Diamond Lu	Test Voltage	Normal Voltage

Occupied Bandwidth:

Emission Type	Frequency (MHz)	99% OBW (kHz)	26dB bandwidth (kHz)	Limit (KHz)	Result
F3E	462.5625	10.003	10.540	12.5	Pass

Emission Designator

Per CFR 47 §2.201& §2.202, $BW = 2M + 2D$ for FM Mode (Channel Spacing: 12.5 kHz)

Emission Designator 11K0F3E

In this case, the maximum modulating frequency is 3.0 kHz with a 2.5 kHz deviation.

$BW = 2(M+D) = 2*(3.0 \text{ kHz} + 2.5 \text{ kHz}) = 11 \text{ kHz} = 11K0$

F3E portion of the designator represents an FM voice transmission

Therefore, the entire designator for 12.5 kHz channel spacing FM mode is 11K0F3E.

Please refer to following page.

Test Plot of Occupied Bandwidth and Emission Mask

Occupied Bandwidth

Emission Mask

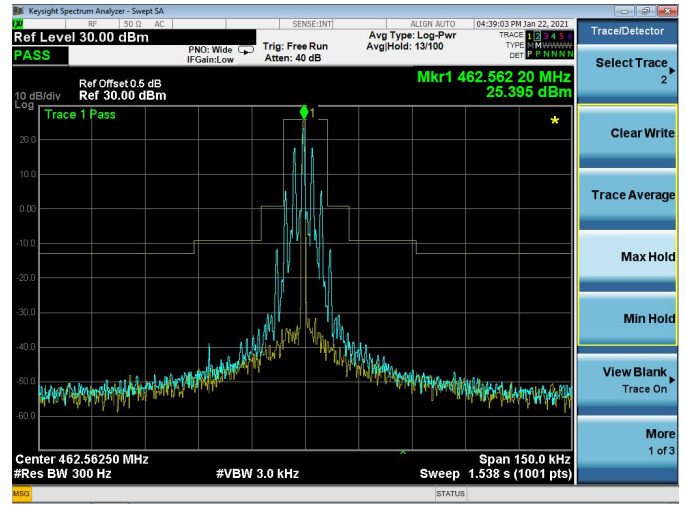
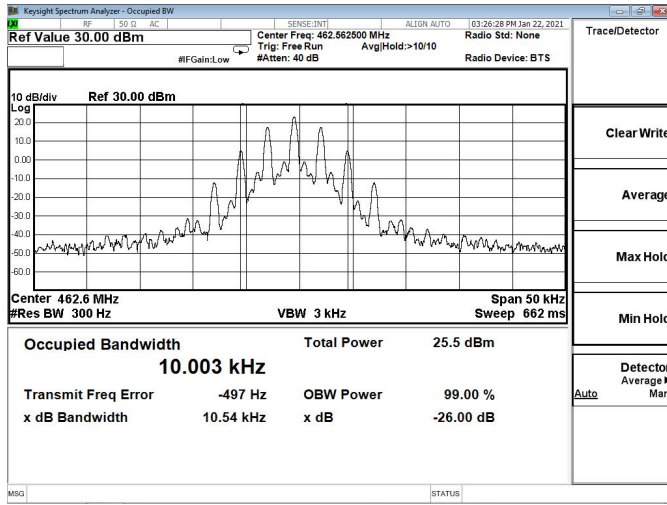

Channel 1: 462.5625MHz

5.3. Modulation Characteristic

5.3.1 Limit

According to CFR47 section 2.1047(a), for Voice Modulation Communication Equipment, the frequency response of the audio modulation circuit over a range of 100 to 5000Hz shall be measured.

According to FCC 95.575:

Each FRS transmitter type must be designed such that the peak frequency deviation does not exceed 2.5 kHz, and the highest audio frequency contributing substantially to modulation must not exceed 3.125 kHz.

5.3.2 Block Diagram of Test Setup

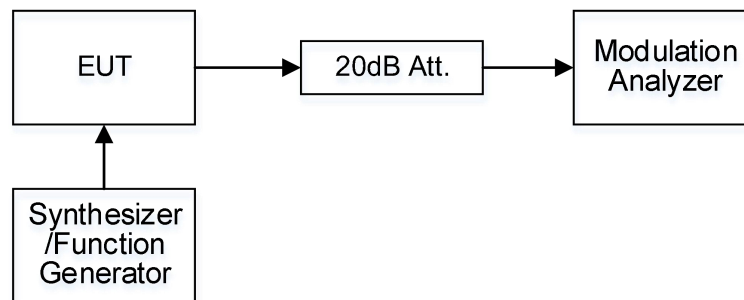

5.3.3 Test Procedure

According to ANSI/TIA-603-E-2016

5.3.4 Test Results

Temperature	23.3°C	Humidity	53.4%
Test Engineer	Diamond Lu	Test Voltage	Normal Voltage

Modulation Limit:

Channel 1: 462.5625MHz					
Modulation Level (dB)	Peak Freq. Deviation At 300Hz (KHz)	Peak Freq. Deviation At 1004Hz (KHz)	Peak Freq. Deviation At 1500Hz (KHz)	Peak Freq. Deviation At 2500Hz (KHz)	Peak Freq. Deviation At 3000Hz (KHz)
-20	0.13	0.29	0.52	0.56	0.74
-15	0.28	0.32	0.54	0.86	0.83
-10	0.47	0.54	0.81	0.93	0.86
-5	0.53	0.7	0.82	1.23	1.46
0	0.77	0.89	1.63	1.83	2.23
+5	0.96	1.23	1.94	1.96	2.35
+10	1.12	1.68	2.13	2.31	2.29
+15	1.52	1.82	2.23	2.14	2.36
+20	1.81	1.83	2.12	2.36	2.53

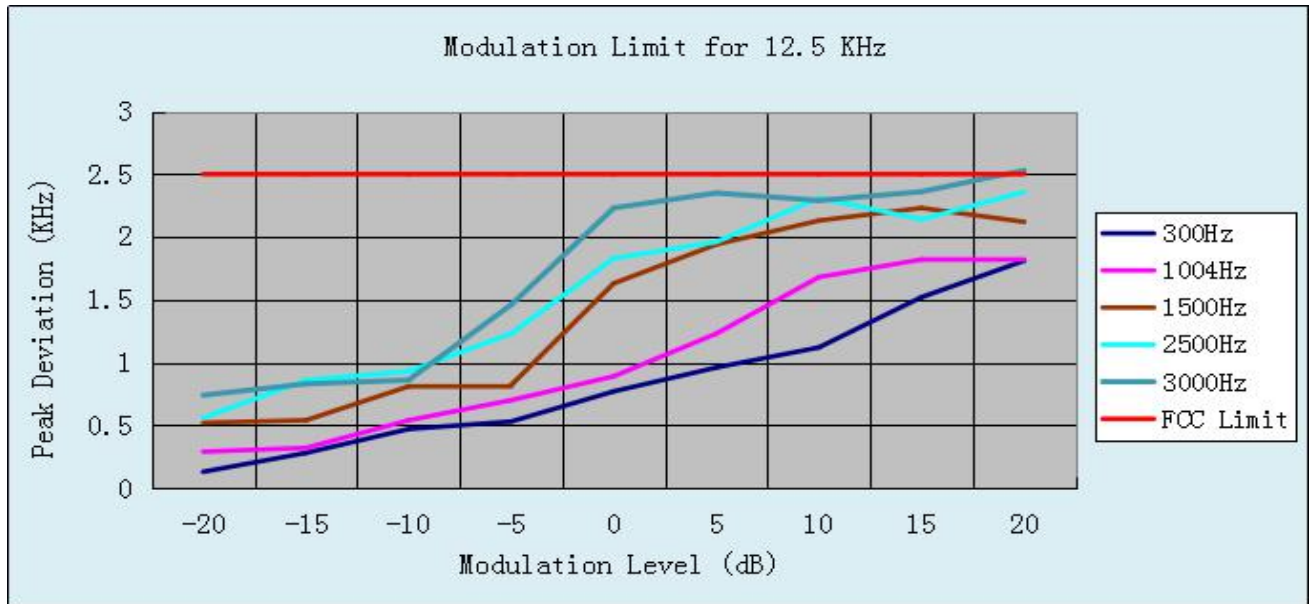

Audio Frequency Response:

Channel 1: 462.5625MHz

Modulation Frequency (Hz)	Peak Freq. Deviation (KHz)	Audio Frequency Response (dB)	Limit (KHz)
100	0.31	-22.44	3.125
200	0.34	-21.45	3.125
300	0.45	-11.37	3.125
400	0.38	-11.45	3.125
500	0.52	-8.36	3.125
600	0.69	-7.03	3.125
700	0.56	-5.35	3.125
800	0.35	-3.45	3.125
900	0.89	-2.02	3.125
1000	1.14	-1.56	3.125
1200	1.45	0.48	3.125
1400	1.62	1.21	3.125
1600	1.87	2.31	3.125
1800	1.84	4.41	3.125
2000	2.52	5.32	3.125
2200	2.13	5.44	3.125
2400	2.31	6.36	3.125
2600	2.35	7.46	3.125
2700	2.45	7.86	3.125
2800	2.12	8.16	3.125
3000	1.52	8.36	3.125
3500	1.52	9.32	3.125
4000	0.90	-20.23	3.125
4500	0.36	-21.37	3.125
5000	0.55	-22.41	3.125

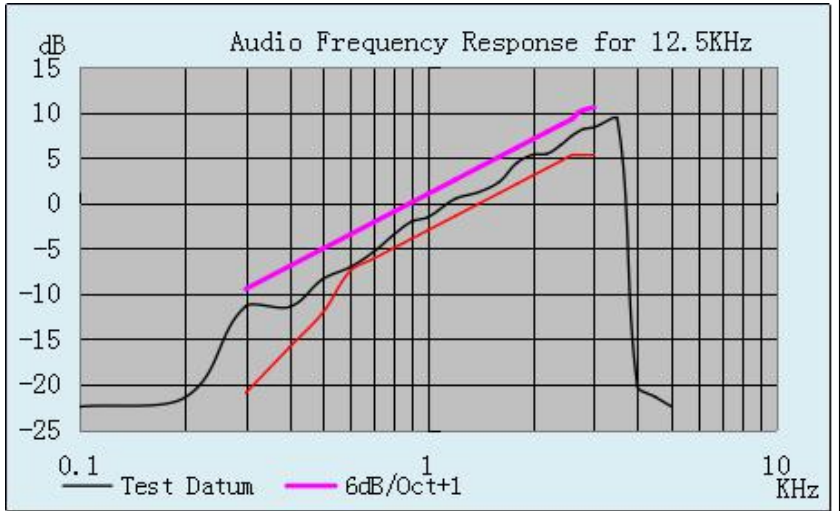
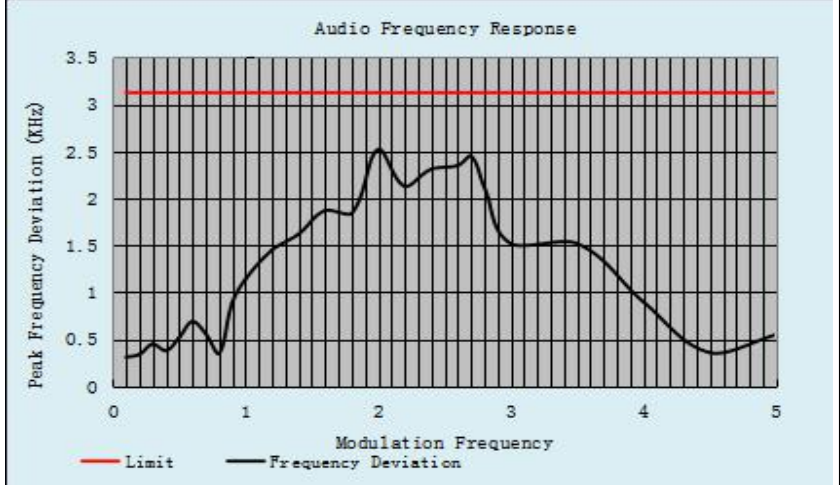

Note: All the modes had been tested, but only the worst data recorded in the report.

5.4. Frequency Stability

5.4.1 Limit

According to FCC 95.565

Each FRS transmitter type must be designed such that the carrier frequencies remain within ± 2.5 parts-per-million of the channel center frequencies specified in §95.563 during normal operating conditions.

5.4.2 Block Diagram of Test Setup

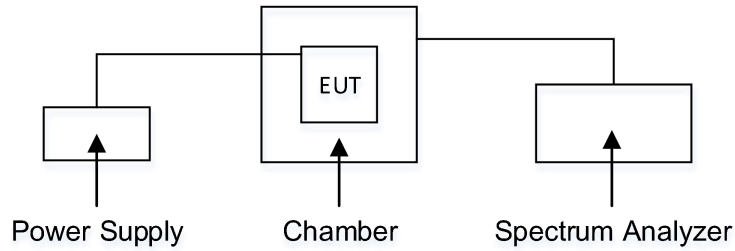

5.4.3 Test Procedure

The EUT was set in the climate chamber and connected to an external DC power supply. The RF output was directly connected to Spectrum Analyzer. The coupling loss of the additional cables was recorded and taken in account for all the measurements. After temperature stabilization (approx. 20 min for each stage), the frequency for the lower, the middle and the highest frequency range was recorded. For Frequency stability Vs. Voltage the EUT was connected to a DC power supply and the voltage was adjusted in the required ranges. The result was recorded.

5.4.4 Test Results

Temperature	23.3°C	Humidity	53.4%
Test Engineer	Diamond Lu	Test Voltage	Normal Voltage

Reference Frequency: 462.5625MHz					
Voltage (V)	Temperature (°C)	Frequency error (Hz)	Frequency Tolerance (%)	Limit (%)	Result
4.5	-30	197	0.000043	0.00025%	Pass
	-20	240	0.000052		
	-10	383	0.000083		
	0	489	0.000106		
	10	483	0.000104		
	20	331	0.000072		
	30	364	0.000079		
	40	435	0.000094		
	50	201	0.000043		
4.2	25	535	0.000116		
4.5	25	462	0.000100		

5.5. Transmitter Radiated Spurious Emission

5.5.1 Limit

According to FCC section 95.579, At least $43 + 10 \log(\text{Transmit Power})$ dB on any frequency band removed from the channel center frequency by more than 31.25 kHz.

5.5.2 Block Diagram of Test Setup

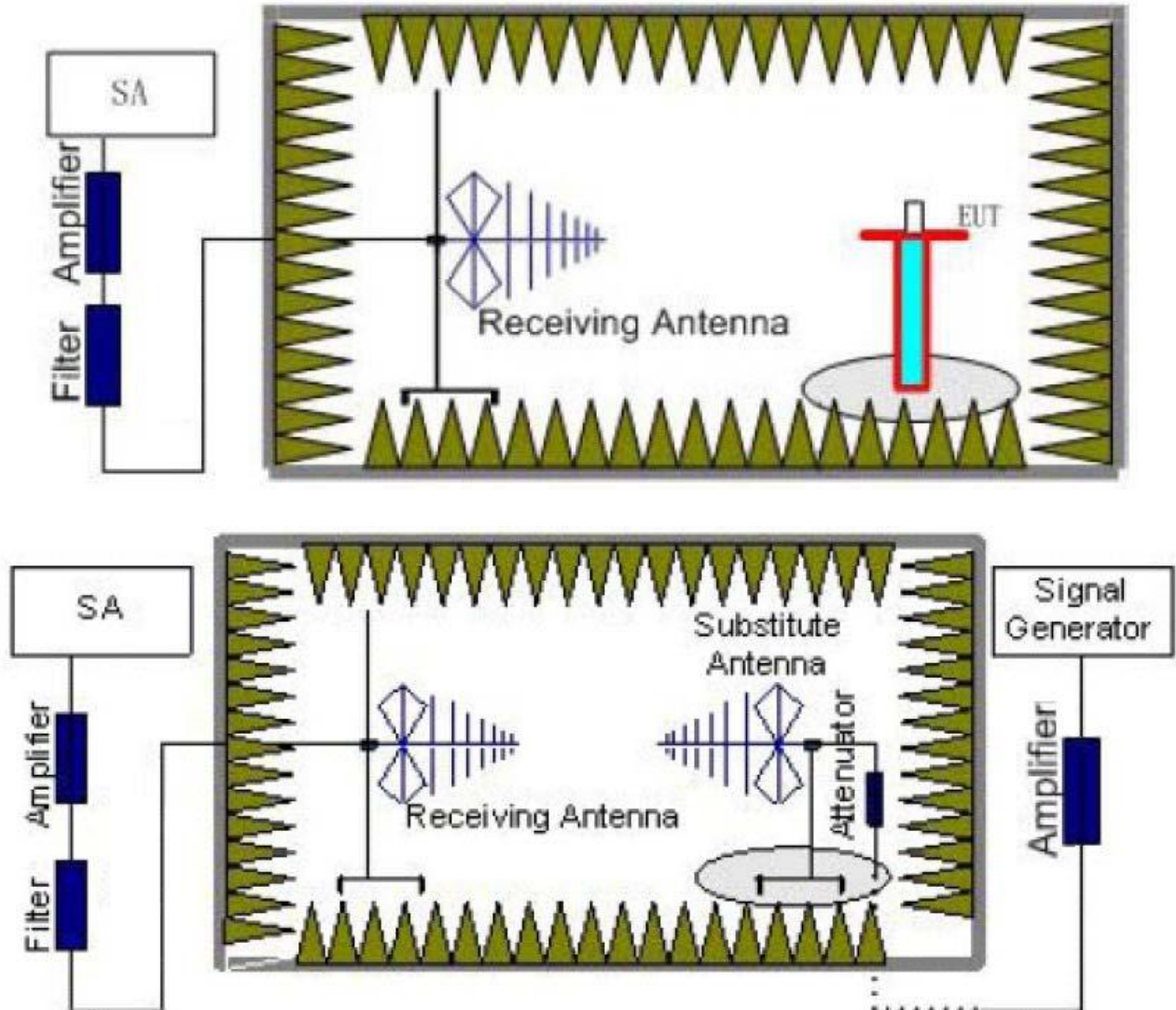

5.5.3 Test Procedure

- EUT was placed on a 1.5 meter high non-conductive stand at a 3 meter test distance from the receive antenna. A receiving antenna was placed on the antenna mast 3 meters from the EUT for emission measurements. The height of receiving antenna is 1.5m. Detected emissions were maximized at each frequency by rotating the EUT through 360° and adjusting the receiving antenna polarization. The radiated emission measurements of all test transmit frequencies were measured with peak detector.
- A log-periodic antenna or double-ridged waveguide horn antenna shall be substituted in place of the EUT. The log-periodic antenna will be driven by a signal generator and the level will be adjusted till the same power value on the spectrum analyzer or receiver. The level of the spurious emissions can be calculated through the level of the signal generator, cable loss, the gain of the substitution antenna and the reading of the spectrum analyzer or receiver.
- The EUT is then put into continuously transmitting mode at its maximum power level during the test. Set Test Receiver or Spectrum 100 kHz below 1GHz and 1MHz above 1GHz, Sweep from 30MHz to the 10th harmonic of the fundamental frequency; and recorded the level of the concerned spurious emission point as (P_T).

- d. The EUT then replaced by a substitution antenna. In the chamber, a substitution antenna for the frequency band of interest is placed at the reference point of the chamber. An RF Signal source for the frequency band of interest is connected to the substitution antenna with a cable that has been constructed to not interfere with the radiation pattern of the antenna. A power (P_{Mea}) is applied to the input of the substitution antenna, and adjust the level of the signal generator output until the value of the receiver reach the previously recorded (P_r). The power of signal source (P_{Mea}) is recorded. The test should be performed by rotating the test item and adjusting the receiving antenna polarization.

The measurement results are obtained as described below:

$$\text{Power (EIRP)} = P_{Mea} - P_{cl} + G_a$$

Where;

P_{Mea} is the recorded signal generator level

P_{cl} is the cable loss connect between instruments

G_a Substitution Antenna Gain

- e. This value is EIRP since the measurement is calibrated using an antenna of known gain (2.15dBi) and known input power.
- f. ERP can be calculated from EIRP by subtracting the gain of the dipole, $ERP = EIRP - 2.15\text{dBi}$.
- g. Test site anechoic chamber refer to ANSI C63.10.

5.5.4 Test Results

Temperature	24.5°C	Humidity	54.1%
Test Engineer	Diamond Lu	Test Voltage	Normal Voltage

Test Frequency (MHz)	Frequency (MHz)	P_{Mea} (dBm)	P_{cl} (dB)	Distance (m)	G_a Antenna Gain(dBi)	Peak EIRP (dBm)	Limit (dBm)	Margin (dB)	Pol.
462.5625	925.12	-29.35	3.54	3.00	12.87	-20.02	-13.00	7.02	V
	1387.68	-32.52	4.21	3.00	15.48	-21.25	-13.00	8.25	V
	1850.25	-38.13	4.52	3.00	17.32	-25.33	-13.00	12.33	V
	2312.81	-40.32	5.24	3.00	18.76	-26.8	-13.00	13.8	V
	925.12	-28.23	3.54	3.00	12.87	-18.9	-13.00	5.9	H
	1387.68	-33.21	4.21	3.00	15.48	-21.94	-13.00	8.94	H
	1850.25	-32.63	4.52	3.00	17.32	-19.83	-13.00	6.83	H
	2312.81	-38.23	5.24	3.00	18.76	-24.71	-13.00	11.71	H

Remark:

- $EIRP = P_{Mea}(\text{dBm}) - P_{cl}(\text{dB}) + G_a(\text{dBi})$
- $\text{Margin} = \text{Limit} - EIRP$
- The Report only recorded the worst result (462.5625MHz).
- The measurement frequency range is from 30MHz to the 10th harmonic of the fundamental frequency, and only recorded worst spurious emissions.

6. SUMMARY OF TEST EQUIPMENT

Item	Equipment	Manufacturer	Model No.	Serial No.	Cal Date	Due Date
1	Power Meter	R&S	NRVS	100444	2020-06-22	2021-06-21
2	Power Sensor	R&S	NRV-Z81	100458	2020-06-22	2021-06-21
3	Power Sensor	R&S	NRV-Z32	10057	2020-06-22	2021-06-21
4	Test Software	Tonscend	JS1120-2	/	N/A	N/A
5	RF Control Unit	Tonscend	JS0806-2	N/A	2020-06-22	2021-06-21
6	MXA Signal Analyzer	Agilent	N9020A	MY50510140	2020-11-21	2021-11-20
7	DC Power Supply	Agilent	E3642A	N/A	2020-11-13	2021-11-12
8	EMI Test Software	AUDIX	E3	/	N/A	N/A
9	EMI Test Software	Farad	EZ	/	N/A	N/A
9	3m Semi Anechoic Chamber	SIDT FRANKONIA	SAC-3M	03CH03-HY	2020-06-22	2021-06-21
10	Positioning Controller	MF	MF7082	MF78020803	2020-06-22	2021-06-21
11	Active Loop Antenna	SCHWARZBEC K	FMZB 1519B	00005	2018-07-26	2021-07-25
12	By-log Antenna	SCHWARZBEC K	VULB9163	9163-470	2018-07-26	2021-07-25
13	Horn Antenna	SCHWARZBEC K	BBHA 9120D	9120D-1925	2018-07-02	2021-07-01
14	Broadband Horn Antenna	SCHWARZBEC K	BBHA 9170	791	2020-09-20	2021-09-19
15	Broadband Preamplifier	SCHWARZBEC K	BBV9745	9719-025	2020-06-22	2021-06-21
16	EMI Test Receiver	R&S	ESR 7	101181	2020-06-22	2021-06-21
17	RS SPECTRUM ANALYZER	R&S	FSP40	100503	2020-11-13	2021-11-12
18	Broadband Preamplifier	/	BP-01M18G	P190501	2020-06-22	2021-06-21
19	RF Cable-R03m	Jye Bao	RG142	CB021	2020-06-22	2021-06-21
20	RF Cable-HIGH	SUHNER	SUCOFLEX 106	03CH03-HY	2020-06-22	2021-06-21
21	6dB Attenuator	/	100W/6dB	1172040	2020-06-22	2021-06-21
22	3dB Attenuator	/	2N-3dB	/	2020-06-22	2021-06-21
23	EMI Test Receiver	R&S	ESPI	101840	2020-06-22	2021-06-21
24	Artificial Mains	R&S	ENV216	101288	2020-06-22	2021-06-21
25	10dB Attenuator	SCHWARZBEC K	MTS-IMP-136	261115-001-0032	2020-06-22	2021-06-21
26	Audio Analyzer	R&S	UPV	1146.2003K02-101 721-UW	2020-06-22	2021-06-21
27	Signal Generator	Agilent	E4438C	MY49072627(3G)	2020-06-22	2021-06-21

Note: All equipment is calibrated through CHINA CEPREI LABORATORY and GUANGZHOU LISAI CALIBRATION AND TEST CO., LTD.

7. TEST SETUP PHOTOGRAPHS OF EUT

Please refer to separated files for Test Setup Photos of the EUT.

8. EXTERIOR PHOTOGRAPHS OF THE EUT

Please refer to separated files for External Photos of the EUT.

9. INTERIOR PHOTOGRAPHS OF THE EUT

Please refer to separated files for Internal Photos of the EUT.

-----THE END OF REPORT-----