



**CFR 47 FCC PART 15 SUBPART C  
ISED RSS-247 ISSUE 2**

**CERTIFICATION TEST REPORT**

*For*

**Smart sensor**

**MODEL NUMBER: WOS3-PC**

**FCC ID: 2AS3F-WOS3PC**

**IC: 25008-WOS3PC**

**REPORT NUMBER: 4790205296.1-1**

**ISSUE DATE: December 10, 2021**

*Prepared for*

**Current Lighting Solutions, LLC  
1975 Noble Road, East Cleveland, Ohio 44112 United States**

*Prepared by*

**UL Verification Services (Guangzhou) Co., Ltd, Song Shan Lake Branch**

**Building 10, Innovation Technology Park, No. 1, Li Bin Road, Song Shan Lake Hi-Tech Development Zone Dongguan, 523808, People's Republic of China**

**Tel: +86 769 22038881**

**Fax: +86 769 33244054**

**Website: [www.ul.com](http://www.ul.com)**



Revision History

<u>Rev.</u>	<u>Issue Date</u>	<u>Revisions</u>	<u>Revised By</u>
V0	12/10/2021	Initial Issue	



Summary of Test Results			
Clause	Test Items	FCC/ISED Rules	Test Results
1	6dB Bandwidth and 99% Occupied Bandwidth	FCC Part 15.247 (a) (2) RSS-247 Clause 5.2 (a) ISED RSS-Gen Clause 6.7	Pass
2	Peak Conducted Output Power	FCC Part 15.247 (b) (3) RSS-247 Clause 5.4 (d)	Pass
3	Power Spectral Density	FCC Part 15.247 (e) RSS-247 Clause 5.2 (b)	Pass
4	Conducted Bandedge and Spurious Emission	FCC Part 15.247 (d) RSS-247 Clause 5.5	Pass
5	Radiated Bandedge and Spurious Emission	FCC Part 15.247 (d) FCC Part 15.209 FCC Part 15.205 RSS-247 Clause 5.5 RSS-GEN Clause 8.9	Pass
6	Antenna Requirement	FCC Part 15.203 RSS-GEN Clause 6.8	Pass
Note: 1. This test report is only published to and used by the applicant, and it is not for evidence purpose in China. 2. The measurement result for the sample received is <Pass> according to < CFR 47 FCC PART 15 SUBPART C >< ISED RSS-247 > when <Accuracy Method> decision rule is applied.			



## TABLE OF CONTENTS

<b>1. ATTESTATION OF TEST RESULTS .....</b>	<b>6</b>
<b>2. TEST METHODOLOGY .....</b>	<b>7</b>
<b>3. FACILITIES AND ACCREDITATION .....</b>	<b>7</b>
<b>4. CALIBRATION AND UNCERTAINTY .....</b>	<b>8</b>
4.1. <i>MEASURING INSTRUMENT CALIBRATION .....</i>	<i>8</i>
4.2. <i>MEASUREMENT UNCERTAINTY.....</i>	<i>8</i>
<b>5. EQUIPMENT UNDER TEST .....</b>	<b>9</b>
5.1. <i>DESCRIPTION OF EUT .....</i>	<i>9</i>
5.2. <i>CHANNEL LIST.....</i>	<i>9</i>
5.3. <i>MAXIMUM PEAK OUTPUT POWER.....</i>	<i>9</i>
5.4. <i>TEST CHANNEL CONFIGURATION.....</i>	<i>9</i>
5.5. <i>THE WORSE CASE POWER SETTING PARAMETER.....</i>	<i>9</i>
5.6. <i>DESCRIPTION OF AVAILABLE ANTENNAS .....</i>	<i>10</i>
5.7. <i>DESCRIPTION OF TEST SETUP.....</i>	<i>11</i>
<b>6. MEASURING INSTRUMENT AND SOFTWARE USED .....</b>	<b>12</b>
<b>7. ANTENNA PORT TEST RESULTS .....</b>	<b>14</b>
7.1. <i>ON TIME AND DUTY CYCLE.....</i>	<i>14</i>
7.2. <i>6 dB DTS BANDWIDTH AND 99 % OCCUPIED BANDWIDTH .....</i>	<i>15</i>
7.3. <i>CONDUCTED OUTPUT POWER.....</i>	<i>17</i>
7.4. <i>POWER SPECTRAL DENSITY.....</i>	<i>18</i>
7.5. <i>CONDUCTED BANDEDGE AND SPURIOUS EMISSIONS.....</i>	<i>20</i>
<b>8. RADIATED TEST RESULTS.....</b>	<b>22</b>
8.1. <i>RESTRICTED BANDEDGE.....</i>	<i>28</i>
8.2. <i>SPURIOUS EMISSIONS (1 GHz ~ 3 GHz).....</i>	<i>31</i>
8.3. <i>SPURIOUS EMISSIONS (3 GHz ~ 18 GHz).....</i>	<i>37</i>
8.4. <i>SPURIOUS EMISSIONS (18 GHz ~ 26 GHz).....</i>	<i>43</i>
8.5. <i>SPURIOUS EMISSIONS (30 MHz ~ 1 GHz).....</i>	<i>45</i>
8.6. <i>SPURIOUS EMISSIONS BELOW 30 MHz .....</i>	<i>47</i>
<b>9. ANTENNA REQUIREMENTS.....</b>	<b>50</b>
<b>10. APPENDIX.....</b>	<b>51</b>
10.1. <i>Appendix A: DTS Bandwidth .....</i>	<i>51</i>



---

10.1.1.	Test Result.....	51
10.1.2.	Test Graphs .....	52
10.2.	<i>Appendix B: Occupied Channel Bandwidth .....</i>	<i>53</i>
10.2.1.	Test Result.....	53
10.2.2.	Test Graphs .....	54
10.3.	<i>Appendix C: Maximum conducted output power.....</i>	<i>55</i>
10.3.1.	Test Result.....	55
10.4.	<i>Appendix D: Maximum power spectral density .....</i>	<i>56</i>
10.4.1.	Test Result.....	56
10.4.1.	Test Graphs .....	57
10.5.	<i>Appendix E: Band edge measurements .....</i>	<i>58</i>
10.5.1.	Test Result.....	58
10.5.2.	Test Graphs .....	59
10.6.	<i>Appendix F: Conducted Spurious Emission.....</i>	<i>60</i>
10.6.1.	Test Result.....	60
10.6.2.	Test Graphs .....	61
10.7.	<i>Appendix G: Duty Cycle .....</i>	<i>63</i>
10.7.1.	Test Result.....	63
10.7.2.	Test Graphs .....	64



# 1. ATTESTATION OF TEST RESULTS

## Applicant Information

Company Name: Current Lighting Solutions, LLC  
Address: 1975 Noble Road, East Cleveland, Ohio 44112 United States

## Manufacturer Information

Company Name: Current Lighting Solutions, LLC  
Address: 1975 Noble Road, East Cleveland, Ohio 44112 United States

## EUT Information

EUT Name: Smart sensor  
Model: WOS3-PC  
Sample Received Date: December 2, 2021  
Sample Status: Normal  
Sample ID: 4439891  
Date of Tested: December 2, 2021~ December 9, 2021

APPLICABLE STANDARDS	
STANDARD	TEST RESULTS
CFR 47 FCC PART 15 SUBPART C	PASS
ISED RSS-247 Issue 2	PASS
ISED RSS-GEN Issue 5	PASS

Prepared By:

Checked By:

Kebo Zhang  
Project Engineer

Shawn Wen  
Laboratory Leader

Approved By:

Stephen Guo  
Laboratory Manager



## 2. TEST METHODOLOGY

The tests documented in this report were performed in accordance with KDB 558074 D01 15.247 Meas Guidance v05r02, 414788 D01 Radiated Test Site v01r01, CFR 47 FCC Part 2, CFR 47 FCC Part 15, ANSI C63.10-2013, ISED RSS-247 Issue 2 and ISED RSS-GEN Issue 5.

## 3. FACILITIES AND ACCREDITATION

Accreditation Certificate	<p><b>A2LA (Certificate No.: 4102.01)</b> UL Verification Services (Guangzhou) Co., Ltd. Song Shan Lake Branch. has been assessed and proved to be in compliance with A2LA.</p> <p><b>FCC (FCC Designation No.: CN1187)</b> UL Verification Services (Guangzhou) Co., Ltd. Song Shan Lake Branch. Has been recognized to perform compliance testing on equipment subject to the Commission's Declaration of Conformity (DoC) and Certification rules</p> <p><b>ISED (Company No.: 21320)</b> UL Verification Services (Guangzhou) Co., Ltd. Song Shan Lake Branch. has been registered and fully described in a report filed with ISED. The Company Number is 21320 and the test lab Conformity Assessment Body Identifier (CABID) is CN0046.</p> <p><b>VCCI (Registration No.: G-20019, R-20004, C-20012 and T-20011)</b> UL Verification Services (Guangzhou) Co., Ltd. Song Shan Lake Branch. has been assessed and proved to be in compliance with VCCI, the Membership No. is 3793. Facility Name: Chamber D, the VCCI registration No. is G-20019 and R-20004 Shielding Room B, the VCCI registration No. is C-20012 and T-20011</p>
---------------------------	------------------------------------------------------------------------------------------------------------------------------------------------------------------------------------------------------------------------------------------------------------------------------------------------------------------------------------------------------------------------------------------------------------------------------------------------------------------------------------------------------------------------------------------------------------------------------------------------------------------------------------------------------------------------------------------------------------------------------------------------------------------------------------------------------------------------------------------------------------------------------------------------------------------------------------------------------------------------------------------------------------------------------------------------------------------------------------------------------------------------------------------------------------------------

Note 1: All tests measurement facilities use to collect the measurement data are located at Building 10, Innovation Technology Park, Song Shan Lake Hi tech Development Zone, Dongguan, 523808, China

Note 2: The test anechoic chamber in UL Verification Services (Guangzhou) Co., Ltd. Song Shan Lake Branch had been calibrated and compared to the open field sites and the test anechoic chamber is shown to be equivalent to or worst case from the open field site.

Note 3: For below 30 MHz, lab had performed measurements at test anechoic chamber and comparing to measurements obtained on an open field site. And these measurements below 30 MHz had been correlated to measurements performed on an OFS.



## 4. CALIBRATION AND UNCERTAINTY

### 4.1. MEASURING INSTRUMENT CALIBRATION

The measuring equipment utilized to perform the tests documented in this report has been calibrated in accordance with the manufacturer's recommendations and is traceable to recognize national standards.

### 4.2. MEASUREMENT UNCERTAINTY

Where relevant, the following measurement uncertainty levels have been estimated for tests performed on the apparatus:

Test Item	Uncertainty
Conduction emission	3.62 dB
Radiated Emission (Included Fundamental Emission) (9 kHz ~ 30 MHz)	2.2 dB
Radiated Emission (Included Fundamental Emission) (30 MHz ~ 1 GHz)	4.00 dB
Radiated Emission (Included Fundamental Emission) (1 GHz to 26 GHz)	5.78 dB (1 GHz ~ 18 GHz)
	5.23 dB (18 GHz ~ 26 GHz)
Duty Cycle	±0.028%
DTS and 99% Occupied Bandwidth	±0.0196%
Maximum Conducted Output Power	±0.686 dB
Maximum Power Spectral Density Level	±0.743 dB
Conducted Band-edge Compliance	±1.328 dB
Conducted Unwanted Emissions In Non-restricted Frequency Bands	±0.746 dB (9 kHz ~ 1 GHz)
	±1.328dB (1 GHz ~ 26 GHz)
Note: This uncertainty represents an expanded uncertainty expressed at approximately the 95% confidence level using a coverage factor of k=2.	





## 5. EQUIPMENT UNDER TEST

### 5.1. DESCRIPTION OF EUT

EUT Name	Smart sensor		
Model	WOS3-PC		
Product Description	Operation Frequency	2405 MHz ~ 2480 MHz	
	Modulation Type	Data Rate	
	O-QPSK	250kbps	
Rated Input	DC 3 V		

### 5.2. CHANNEL LIST

Channel	Frequency (MHz)	Channel	Frequency (MHz)	Channel	Frequency (MHz)	Channel	Frequency (MHz)
11	2405	15	2425	19	2445	23	2465
12	2410	16	2430	20	2450	24	2470
13	2415	17	2435	21	2455	25	2475
14	2420	18	2440	22	2460	26	2480

### 5.3. MAXIMUM PEAK OUTPUT POWER

Mode	Frequency (MHz)	Channel Number	Max Output PEAK Power (dBm)
Zigbee	2405-2480	11-26 [11]	6.31

### 5.4. TEST CHANNEL CONFIGURATION

Test Mode	Test Channel	Frequency
ZigBee	CH 11, CH 19, CH 26	2405MHz, 2445MHz, 2480MHz

### 5.5. THE WORSE CASE POWER SETTING PARAMETER

The Worse Case Power Setting Parameter under 2400 ~ 2483.5MHz Band				
Test Software		UartAssis		
Modulation Type	Transmit Antenna Number	Test Channel		
		CH 11	CH 19	CH 26
O-QPSK	1	5	5	5



### 5.6. DESCRIPTION OF AVAILABLE ANTENNAS

Ant.	Frequency (MHz)	Antenna Type	Antenna Gain (dBi)
1	2405-2480	IFA	2.86

Test Mode	Transmit and Receive Mode	Description
Zigbee	<input checked="" type="checkbox"/> 1TX, 1RX	Chain 1 can be used as transmitting/receiving antenna.

Note: 1. The value of the antenna gain was declared by customer.

## 5.7. DESCRIPTION OF TEST SETUP

### SUPPORT EQUIPMENT

Item	Equipment	Brand Name	Model Name	Remarks
1	Laptop	ThinkPad	X230i	/
2	USB TO UART	/	/	/

### I/O CABLES

Item	Port	Connector Type	Cable Type	Cable Length(m)	Remarks
1	USB	NA	NA	1	/

### ACCESSORY

Item	Accessory	Brand Name	Model Name	Description
1	/	/	/	/

### TEST SETUP

The EUT can work in an engineer mode with software through a Laptop.

### SETUP DIAGRAM FOR TESTS

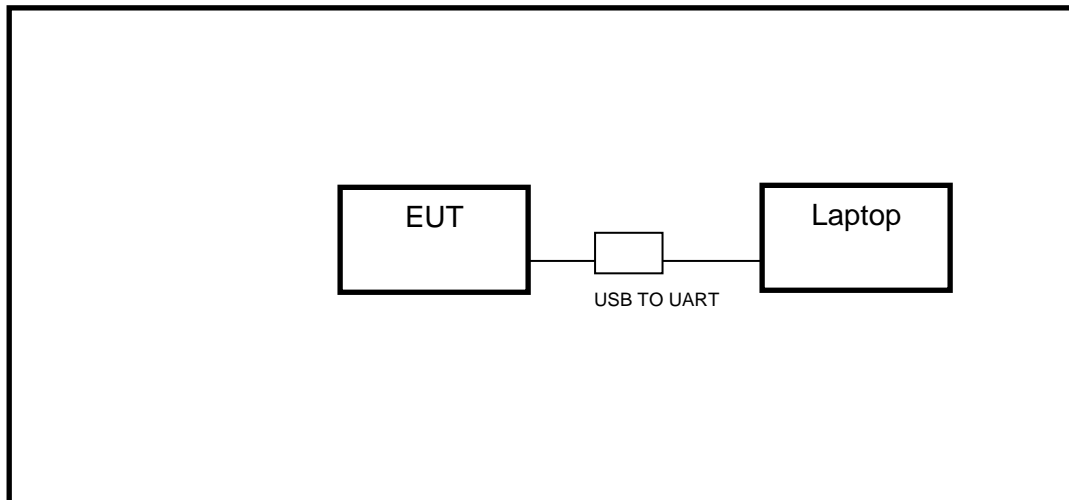

**6. MEASURING INSTRUMENT AND SOFTWARE USED**

Radiated Emissions					
Equipment	Manufacturer	Model No.	Serial No.	Last Cal.	Due Date
MXE EMI Receiver	KESIGHT	N9038A	MY56400036	Oct.30, 2021	Oct.29, 2022
Hybrid Log Periodic Antenna	TDK	HLP-3003C	130959	Aug.02, 2021	Aug.01, 2024
Preamplifier	HP	8447D	2944A09099	Oct.30, 2021	Oct.29, 2022
EMI Measurement Receiver	R&S	ESR26	101377	Oct.30, 2021	Oct.29, 2022
Horn Antenna	TDK	HRN-0118	130940	July 20, 2021	July 19, 2024
Preamplifier	TDK	PA-02-0118	TRS-305-00067	Oct.30, 2021	Oct.29, 2022
Horn Antenna	Schwarzbeck	BBHA9170	697	July 20, 2021	July 19, 2024
Preamplifier	TDK	PA-02-2	TRS-307-00003	Oct.31, 2021	Oct.30, 2022
Preamplifier	TDK	PA-02-3	TRS-308-00002	Oct.31, 2021	Oct.30, 2022
Loop antenna	Schwarzbeck	1519B	00008	Jan.17, 2019	Jan.17,2022
Preamplifier	TDK	PA-02-001-3000	TRS-302-00050	Oct.31, 2021	Oct.30, 2022
Preamplifier	Mini-Circuits	ZX60-83LN-S+	SUP01201941	Oct.31, 2021	Oct.30, 2022
High Pass Filter	Wi	WHKX10-2700-3000-18000-40SS	23	Oct.31, 2021	Oct.30, 2022
Band Reject Filter	Wainwright	WRCJV8-2350-2400-2483.5-2533.5-40SS	4	Oct.31, 2021	Oct.30, 2022
Software					
Description			Manufacturer	Name	Version
Test Software for Radiated Emissions			Farad	EZ-EMC	Ver. UL-3A1



R&S TS 8997 Test System					
Equipment	Manufacturer	Model No.	Serial No.	Last Cal.	Due. Date
Power sensor, Power Meter	R&S	OSP120	100921	Mar.23,2021	Mar.22,2022
Vector Signal Generator	R&S	SMBV100A	261637	Oct.30, 2021	Oct.29, 2022
Signal Generator	R&S	SMB100A	178553	Oct.30, 2021	Oct.29, 2022
Signal Analyzer	R&S	FSV40	101118	Oct.30, 2021	Oct.29, 2022
Software					
Description	Manufacturer	Name		Version	
Tonsend SRD Test System	Tonsend	JS1120-3 RF Test System		2.6.77.0518	

## 7. ANTENNA PORT TEST RESULTS

### 7.1. ON TIME AND DUTY CYCLE

#### LIMITS

None; for reporting purposes only.

#### PROCEDURE

Refer to ANSI C63.10-2013 clause 11.6 Zero – Span Spectrum Analyzer method.

#### TEST SETUP

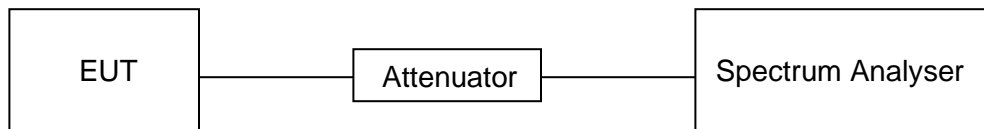

#### TEST ENVIRONMENT

Temperature	23.2 °C	Relative Humidity	43.8 %
Atmosphere Pressure	101 kPa	Test Voltage	DC 3 V

#### RESULTS

Please refer to appendix G.

## 7.2. 6 dB DTS BANDWIDTH AND 99 % OCCUPIED BANDWIDTH

### LIMITS

CFR 47FCC Part15 (15.247) Subpart C ISED RSS-247 ISSUE 2			
Section	Test Item	Limit	Frequency Range (MHz)
CFR 47 FCC 15.247(a)(2) ISED RSS-247 5.2 (a)	6 dB Bandwidth	≥ 500 kHz	2400-2483.5
ISED RSS-Gen Clause 6.7	99 % Occupied Bandwidth	None; for reporting purposes only.	2400-2483.5

### TEST PROCEDURE

Connect the EUT to the spectrum analyser and use the following settings:

Center Frequency	The center frequency of the channel under test
Frequency Span	For 6 dB Bandwidth: Enough to capture all products of the modulation carrier emission For 99 % Occupied Bandwidth: Between 1.5 times and 5.0 times the OBW
Detector	Peak
RBW	For 6 dB Bandwidth: 100 kHz For 99 % Occupied Bandwidth: 1 % to 5 % of the occupied bandwidth
VBW	For 6 dB Bandwidth: ≥3 × RBW For 99 % Occupied Bandwidth: ≥3 × RBW
Trace	Max hold
Sweep	Auto couple

a) Use the 99 % power bandwidth function of the instrument, allow the trace to stabilize and report the measured bandwidth.

b) Allow the trace to stabilize and measure the maximum width of the emission that is constrained by the frequencies associated with the two outermost amplitude points (upper and lower frequencies) that are attenuated by 6 dB relative to the maximum level measured in the fundamental emission.

### TEST SETUP

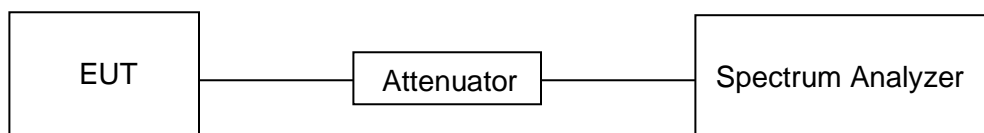



**TEST ENVIRONMENT**

Temperature	23.2 °C	Relative Humidity	43.8 %
Atmosphere Pressure	101 kPa	Test Voltage	DC 3 V

**RESULTS**

Please refer to appendix A & B.



### 7.3. CONDUCTED OUTPUT POWER

#### LIMITS

CFR 47 FCC Part15 (15.247) Subpart C ISED RSS-247 ISSUE 2			
Section	Test Item	Limit	Frequency Range (MHz)
CFR 47 FCC 15.247(b)(3) ISED RSS-247 5.4 (d)	Peak Conducted Output Power	1 watt or 30 dBm	2400-2483.5

#### TEST PROCEDURE

Connect the EUT to a low loss RF cable from the antenna port to the power sensor (video bandwidth is greater than the occupied bandwidth). Measure peak emission level, the indicated level is the peak output power, after any corrections for external attenuators and cables.

#### TEST SETUP

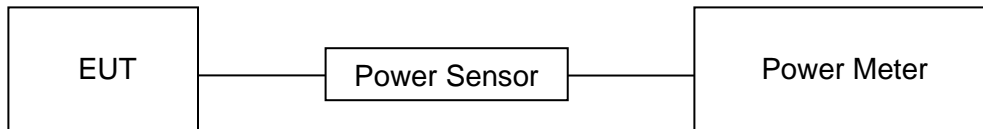

#### TEST ENVIRONMENT

Temperature	23.2 °C	Relative Humidity	43.8 %
Atmosphere Pressure	101 kPa	Test Voltage	DC 3 V

#### RESULTS

Please refer to appendix C.

## 7.4. POWER SPECTRAL DENSITY

### LIMITS

CFR 47 FCC Part15 (15.247) Subpart C ISED RSS-247 ISSUE 2			
Section	Test Item	Limit	Frequency Range (MHz)
CFR 47 FCC §15.247 (e) ISED RSS-247 5.2 (b)	Power Spectral Density	8 dBm in any 3 kHz band	2400-2483.5

### TEST PROCEDURE

Connect the EUT to the spectrum analyser and use the following settings:

Center Frequency	The center frequency of the channel under test
Detector	Peak
RBW	$3 \text{ kHz} \leq \text{RBW} \leq 100 \text{ kHz}$
VBW	$\geq 3 \times \text{RBW}$
Span	1.5 x DTS bandwidth
Trace	Max hold
Sweep time	Auto couple

Allow trace to fully stabilize and use the peak marker function to determine the maximum amplitude level within the RBW.

If measured value exceeds limit, reduce RBW (no less than 3 kHz) and repeat.

### TEST SETUP

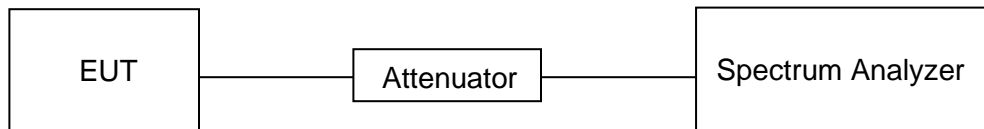

### TEST ENVIRONMENT

Temperature	23.2 °C	Relative Humidity	43.8 %
Atmosphere Pressure	101 kPa	Test Voltage	DC 3 V



**RESULTS**

Please refer to appendix D.



## 7.5. CONDUCTED BANDEGE AND SPURIOUS EMISSIONS

### LIMITS

CFR 47 FCC Part15 (15.247) Subpart C ISED RSS-247 ISSUE 2		
Section	Test Item	Limit
CFR 47 FCC §15.247 (d) ISED RSS-247 5.5	Conducted Bandedge and Spurious Emissions	at least 20 dB below that in the 100 kHz bandwidth within the band that contains the highest level of the desired power

### TEST PROCEDURE

Connect the EUT to the spectrum analyser and use the following settings for reference level measurement:

Center Frequency	The center frequency of the channel under test
Detector	Peak
RBW	100 kHz
VBW	$\geq 3 \times \text{RBW}$
Span	1.5 x DTS bandwidth
Trace	Max hold
Sweep time	Auto couple.

Allow trace to fully stabilize and use the peak marker function to determine the maximum PSD level.

Change the settings for emission level measurement:

Span	Set the center frequency and span to encompass frequency range to be measured
Detector	Peak
RBW	100 kHz
VBW	$\geq 3 \times \text{RBW}$
measurement points	$\geq \text{span}/\text{RBW}$
Trace	Max hold
Sweep time	Auto couple.

Allow trace to fully stabilize and use the peak marker function to determine the maximum PSD level. Ensure that the amplitude of all unwanted emissions outside of the authorized frequency band (excluding restricted frequency bands) is attenuated by at least the minimum requirements specified in 11.11.



**TEST SETUP**

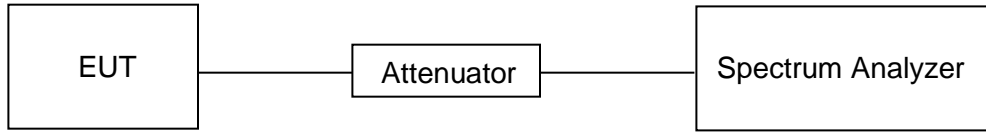

**TEST ENVIRONMENT**

Temperature	23.2 °C	Relative Humidity	43.8 %
Atmosphere Pressure	101 kPa	Test Voltage	DC 3 V

**RESULTS**

Please refer to appendix E & F.

## 8. RADIATED TEST RESULTS

### LIMITS

Please refer to CFR 47 FCC §15.205 and §15.209.

Please refer to ISED RSS-GEN Clause 8.9 and Clause 8.10.

Radiation Disturbance Test Limit for FCC (Class B) (9 kHz-1 GHz)

Emissions radiated outside of the specified frequency bands above 30 MHz			
Frequency Range (MHz)	Field Strength Limit (uV/m) at 3 m	Field Strength Limit (dBuV/m) at 3 m	
		Quasi-Peak	
30 - 88	100	40	
88 - 216	150	43.5	
216 - 960	200	46	
Above 960	500	54	
Above 1000	500	Peak	Average
		74	54

FCC Emissions radiated outside of the specified frequency bands below 30 MHz		
Frequency (MHz)	Field strength (microvolts/meter)	Measurement distance (meters)
0.009-0.490	2400/F(kHz)	300
0.490-1.705	24000/F(kHz)	30
1.705-30.0	30	30

ISED General field strength limits at frequencies below 30 MHz

Table 6 – General field strength limits at frequencies below 30 MHz		
Frequency	Magnetic field strength (H-Field) (µA/m)	Measurement distance (m)
9 - 490 kHz <sup>Note 1</sup>	6.37/F (F in kHz)	300
490 - 1705 kHz	63.7/F (F in kHz)	30
1.705 - 30 MHz	0.08	30

**Note 1:** The emission limits for the ranges 9-90 kHz and 110-490 kHz are based on measurements employing a linear average detector.



ISED Restricted bands please refer to ISED RSS-GEN Clause 8.10

**Table 7 – Restricted frequency bands<sup>Note 1</sup>**

MHz	MHz	GHz
0.090 - 0.110	149.9 - 150.05	9.0 - 9.2
0.495 - 0.505	156.52475 - 156.52525	9.3 - 9.5
2.1735 - 2.1905	156.7 - 156.9	10.6 - 12.7
3.020 - 3.028	162.0125 - 167.17	13.25 - 13.4
4.125 - 4.128	167.72 - 173.2	14.47 - 14.5
4.17725 - 4.17775	240 - 285	15.35 - 16.2
4.20725 - 4.20775	322 - 335.4	17.7 - 21.4
5.677 - 5.683	399.9 - 410	22.01 - 23.12
6.215 - 6.218	608 - 614	23.6 - 24.0
6.26775 - 6.26825	960 - 1427	31.2 - 31.8
6.31175 - 6.31225	1435 - 1626.5	36.43 - 36.5
8.291 - 8.294	1645.5 - 1646.5	Above 38.6
8.362 - 8.366	1660 - 1710	
8.37625 - 8.38675	1718.8 - 1722.2	
8.41425 - 8.41475	2200 - 2300	
12.29 - 12.293	2310 - 2390	
12.51975 - 12.52025	2483.5 - 2500	
12.57675 - 12.57725	2655 - 2900	
13.36 - 13.41	3260 - 3267	
16.42 - 16.423	3332 - 3339	
16.69475 - 16.69525	3345.8 - 3358	
16.80425 - 16.80475	3500 - 4400	
25.5 - 25.67	4500 - 5150	
37.5 - 38.25	5350 - 5460	
73 - 74.6	7250 - 7750	
74.8 - 75.2	8025 - 8500	
108 - 138		

**Note 1:** Certain frequency bands listed in table 7 and in bands above 38.6 GHz are designated for licence-exempt applications. These frequency bands and the requirements that apply to related devices are set out in the 200 and 300 series of RSSs.

FCC Restricted bands of operation refer to FCC §15.205 (a):

MHz	MHz	MHz	GHz
0.090-0.110	16.42-16.423	399.9-410	4.5-5.15
<sup>1</sup> 0.495-0.505	16.69475-16.69525	608-614	5.35-5.46
2.1735-2.1905	16.80425-16.80475	960-1240	7.25-7.75
4.125-4.128	25.5-25.67	1300-1427	8.025-8.5
4.17725-4.17775	37.5-38.25	1435-1626.5	9.0-9.2
4.20725-4.20775	73-74.6	1645.5-1646.5	9.3-9.5
6.215-6.218	74.8-75.2	1660-1710	10.6-12.7
6.26775-6.26825	108-121.94	1718.8-1722.2	13.25-13.4
6.31175-6.31225	123-138	2200-2300	14.47-14.5
8.291-8.294	149.9-150.05	2310-2390	15.35-16.2
8.362-8.366	156.52475-156.52525	2483.5-2500	17.7-21.4
8.37625-8.38675	156.7-156.9	2690-2900	22.01-23.12
8.41425-8.41475	162.0125-167.17	3260-3267	23.6-24.0
12.29-12.293	167.72-173.2	3332-3339	31.2-31.8
12.51975-12.52025	240-285	3345.8-3358	36.43-36.5
12.57675-12.57725	322-335.4	3600-4400	( <sup>2</sup> )
13.36-13.41			

Note: <sup>1</sup>Until February 1, 1999, this restricted band shall be 0.490-0.510 MHz.  
<sup>2</sup>Above 38.6c

**TEST SETUP AND PROCEDURE**

Below 30 MHz

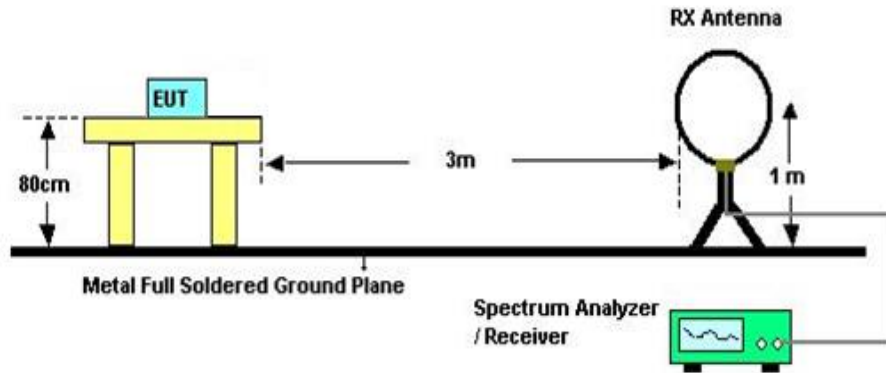

The setting of the spectrum analyser

RBW	200 Hz (From 9 kHz to 0.15 MHz)/ 9 kHz (From 0.15 MHz to 30 MHz)
VBW	200 Hz (From 9 kHz to 0.15 MHz)/ 9 kHz (From 0.15 MHz to 30 MHz)
Sweep	Auto
Trace	Max hold

1. The testing follows the guidelines in ANSI C63.10-2013 clause 6.4.
2. The EUT was arranged to its worst case and then turntable (from 0 degree to 360 degrees) to find the maximum reading. A pre-amp and a high pass filter are used for the test in order to get better signal level. Both Horizontal, Face-on and Face-off polarizations of the antenna are set to make the measurement.
3. The EUT was placed on a turntable with 80 cm above ground.
4. The EUT was set 3 meters from the interference receiving antenna, which was mounted on the top of a 1 m height antenna tower.
5. The radiated emission limits are based on measurements employing a CISPR quasi-peak detector except for the frequency bands 9-90 kHz, 110-490 kHz and above 1000 MHz. Radiated emission limits in these three bands are based on measurements employing an average detector.
6. For measurement below 1 GHz, the initial step in collecting conducted emission data is a spectrum analyzer peak detector mode pre-scanning the measurement frequency range. Significant peaks are then marked and then Quasi Peak and average detector mode re-measured. If the emission level of the EUT measured by the peak detector is 3 dB lower than the applicable limit, the peak emission level will be reported. Otherwise, the emission measurement will be repeated using the quasi-peak and average detector and reported.
7. The limits in CFR 47, Part 15, Subpart C, paragraph 15.209 (a), are identical to those in RSS-GEN Section 8.9, Table 6, since the measurements are performed in terms of magnetic field strength and converted to electric field strength levels (as reported in the table) using the free space impedance of 377Ω. For example, the measurement frequency X KHz resulted in a level of Y dBuV/m, which is equivalent to  $Y-51.5 = Z$  dBuA/m, which has the same margin, W dB, to the corresponding RSS-GEN Table 6 limit as it has to be 15.209(a) limit.



Below 1 GHz and above 30 MHz

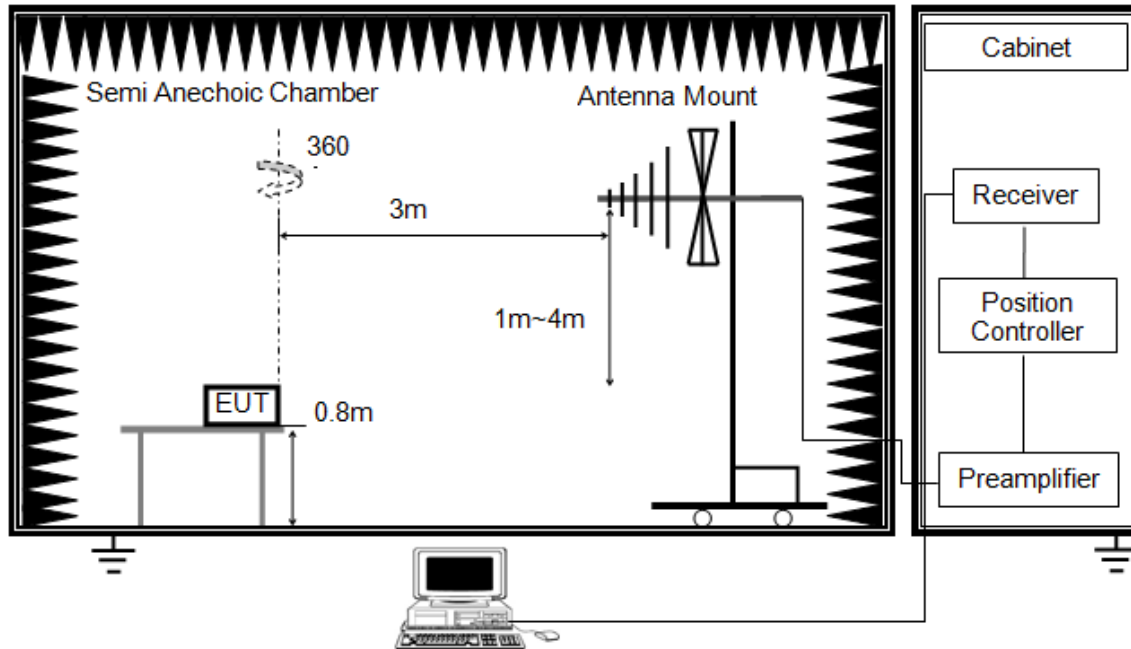

The setting of the spectrum analyser

RBW	120 kHz
VBW	300 kHz
Sweep	Auto
Detector	Peak/QP
Trace	Max hold

1. The testing follows the guidelines in ANSI C63.10-2013 clause 6.5.
2. The EUT was arranged to its worst case and then tune the antenna tower (from 1 m to 4 m) and turntable (from 0 degree to 360 degrees) to find the maximum reading. A pre-amp and a high pass filter are used for the test in order to get better signal level. Both horizontal and vertical polarizations of the antenna are set to make the measurement.
3. The EUT was placed on a turntable with 80 cm above ground.
4. The EUT was set 3 meters from the interference receiving antenna, which was mounted on the top of a variable height antenna tower.
5. For measurement below 1 GHz, the initial step in collecting conducted emission data is a spectrum analyzer peak detector mode pre-scanning the measurement frequency range. Significant peaks are then marked and then Quasi Peak detector mode re-measured. If the emission level of the EUT measured by the peak detector is 3 dB lower than the applicable limit, the peak emission level will be reported. Otherwise, the emission measurement will be repeated using the quasi-peak detector and reported.

Above 1 GHz

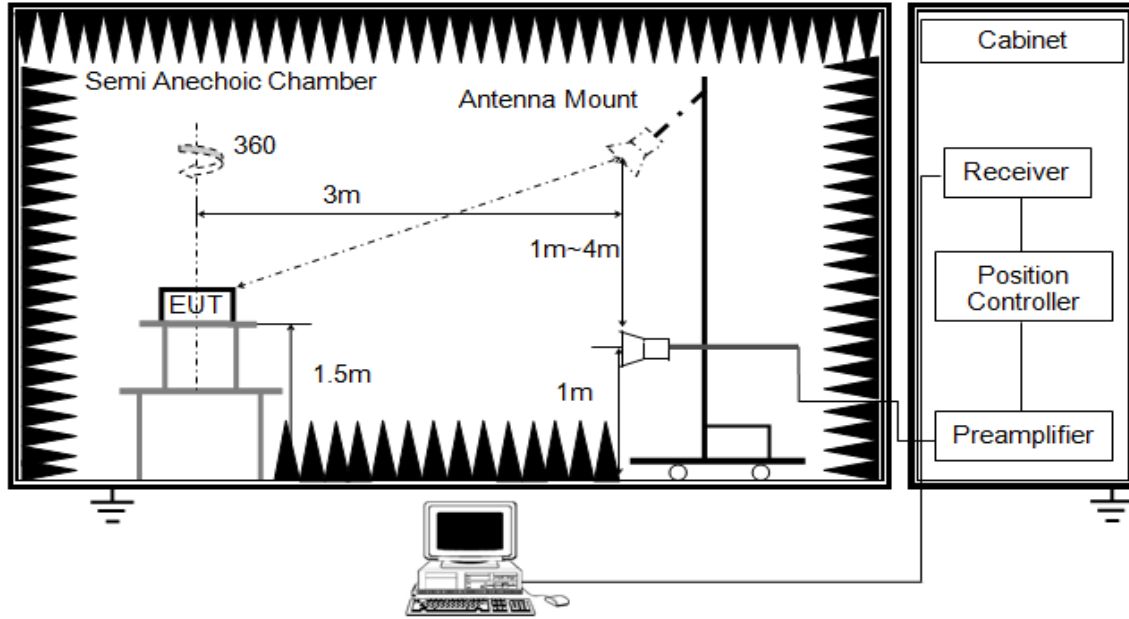

The setting of the spectrum analyser

RBW	1 MHz
VBW	PEAK: 3 MHz AVG: see note 6
Sweep	Auto
Detector	Peak
Trace	Max hold

1. The testing follows the guidelines in ANSI C63.10-2013 clause 6.6.
2. The EUT was arranged to its worst case and then tune the antenna tower (from 1 m to 4 m) and turntable (from 0 degree to 360 degrees) to find the maximum reading. A pre-amp and a high pass filter are used for the test in order to get better signal level. Both horizontal and vertical polarizations of the antenna are set to make the measurement.
3. The EUT was placed on a turntable with 1.5 m above ground.
4. The EUT was set 3 meters from the interference receiving antenna, which was mounted on the top of a variable height antenna tower.
5. For measurement above 1 GHz, the emission measurement will be measured by the peak detector. This peak level, once corrected, must comply with the limit specified in Section 15.209.
6. For measurements above 1 GHz the resolution bandwidth is set to 1 MHz, then the video bandwidth is set to 3 MHz for peak measurements and 1 MHz resolution bandwidth with 1/T video bandwidth with peak detector for average measurements. For the Duty Cycle please refer to clause 7.1.ON TIME AND DUTY CYCLE.

X axis, Y axis, Z axis positions:

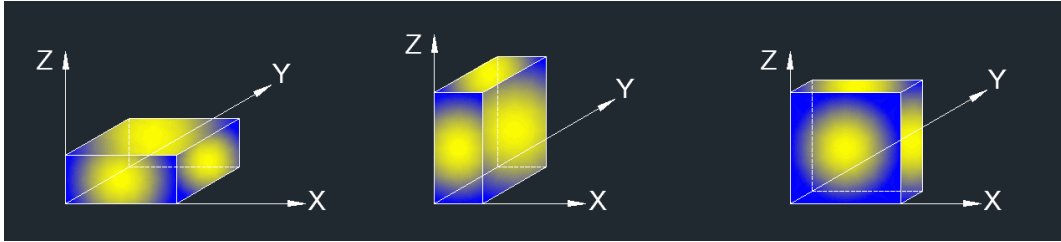

Note 1: For all radiated test, EUT in each of three orthogonal axis emissions had been tested, but only the worst case (X axis) data recorded in the report.

**TEST ENVIRONMENT**

Temperature	23.1 °C	Relative Humidity	31.3 %
Atmosphere Pressure	101 kPa	Test Voltage	DC 3 V

**RESULTS**

## 8.1. RESTRICTED BANDEDGE

### RESTRICTED BANDEDGE (LOW CHANNEL, HORIZONTAL)

#### PEAK

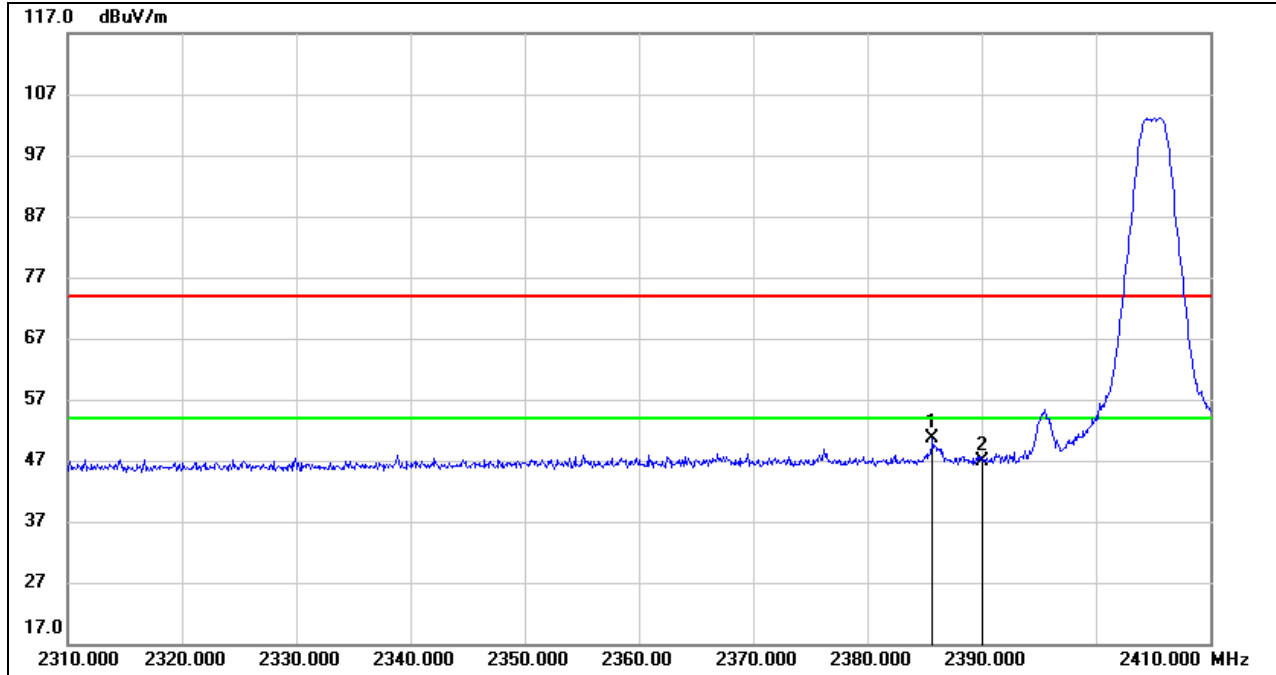

No.	Frequency (MHz)	Reading (dBuV)	Correct (dB/m)	Result (dBuV/m)	Limit (dBuV/m)	Margin (dB)	Remark
1	2385.700	17.93	32.63	50.56	74.00	-23.44	peak
2	2390.000	14.34	32.66	47.00	74.00	-27.00	peak

Note: 1. Measurement = Reading Level + Correct Factor.

2. Peak: Peak detector.

3. Only the worst data was recorded, if it complies with the limit, the other emissions deemed to comply with the limit.

**RESTRICTED BANDEGE (HIGH CHANNEL, HORIZONTAL)**

**PEAK**

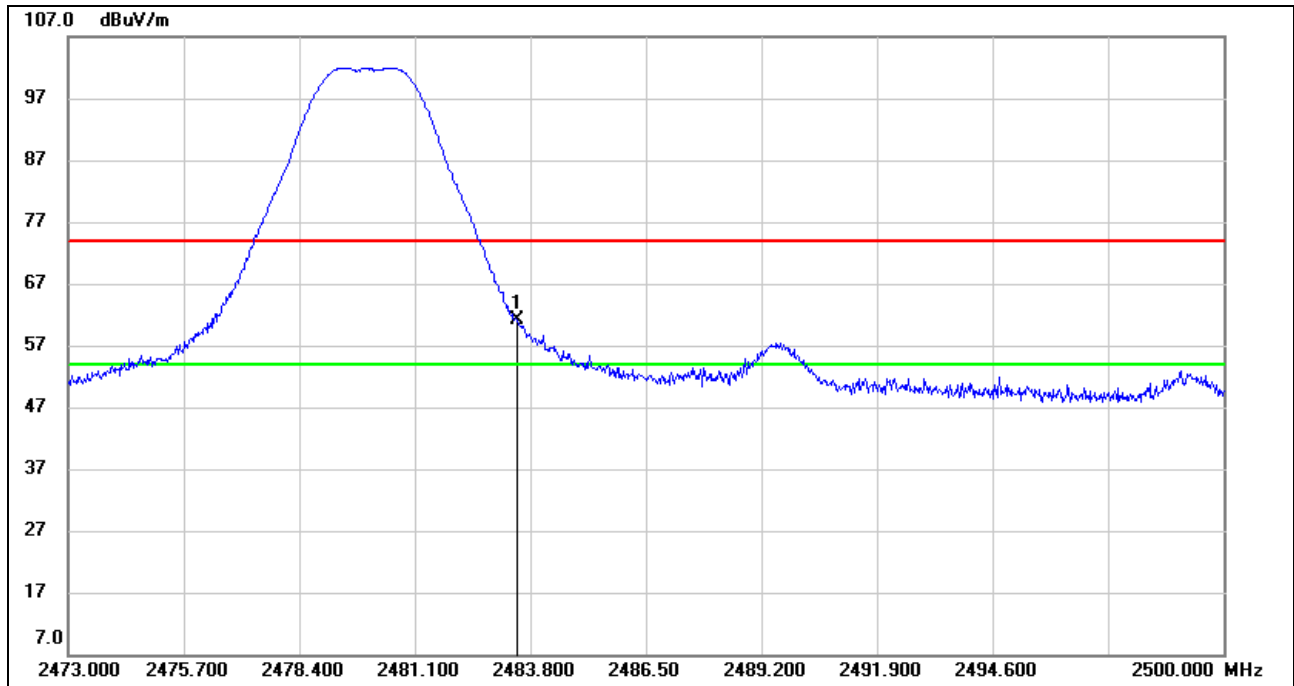

No.	Frequency (MHz)	Reading (dBuV)	Correct (dB/m)	Result (dBuV/m)	Limit (dBuV/m)	Margin (dB)	Remark
1	2483.500	27.92	33.10	61.02	74.00	-12.98	peak

Note: 1. Measurement = Reading Level + Correct Factor.  
 2. Peak: Peak detector.  
 3. Only the worst data was recorded, if it complies with the limit, the other emissions deemed to comply with the limit.

**AVG**

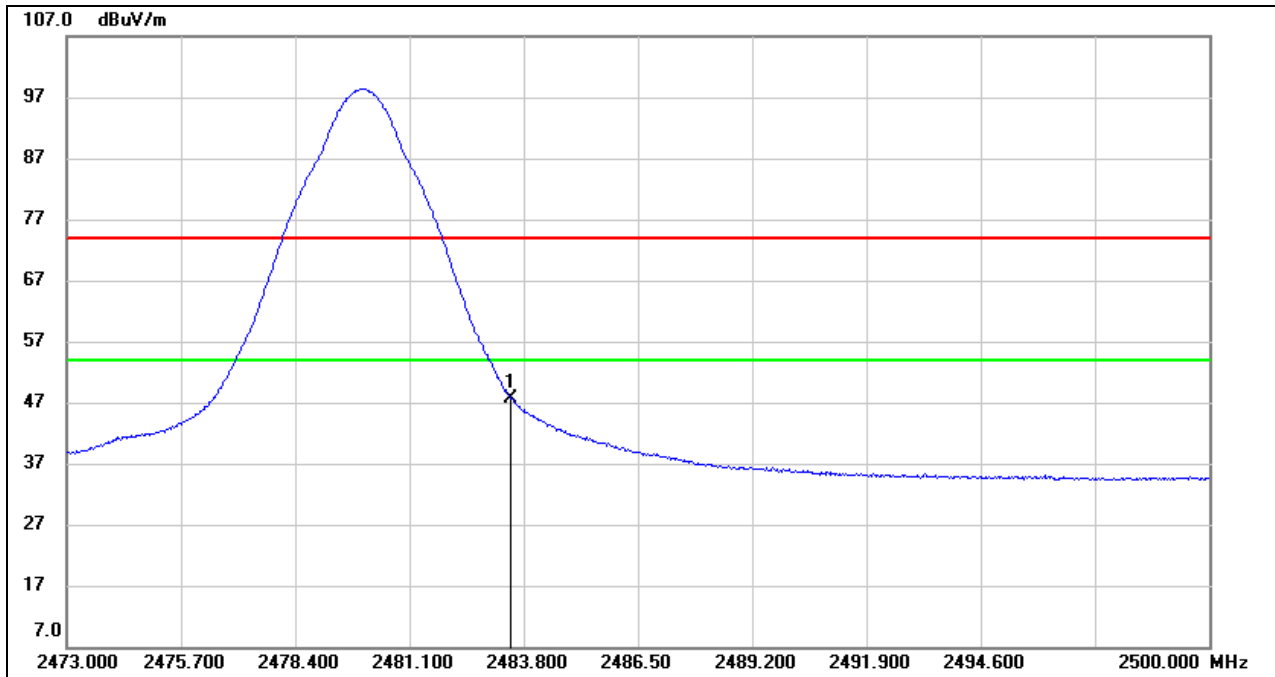

No.	Frequency (MHz)	Reading (dBuV)	Correct (dB/m)	Result (dBuV/m)	Limit (dBuV/m)	Margin (dB)	Remark
1	2483.500	14.58	33.10	47.68	54.00	-6.32	AVG

- Note: 1. Measurement = Reading Level + Correct Factor.  
 2. AVG:  $VBW=1/T_{on}$ , where:  $T_{on}$  is the transmitting duration.  
 3. For the transmitting duration, please refer to clause 7.1.  
 4. Only the worst data was recorded, if it complies with the limit, the other emissions deemed to comply with the limit.

Note: Horizontal and Vertical have been tested, only the worst data was recorded in the report.

## 8.2. SPURIOUS EMISSIONS (1 GHz ~ 3 GHz)

### HARMONICS AND SPURIOUS EMISSIONS (LOW CHANNEL, HORIZONTAL)

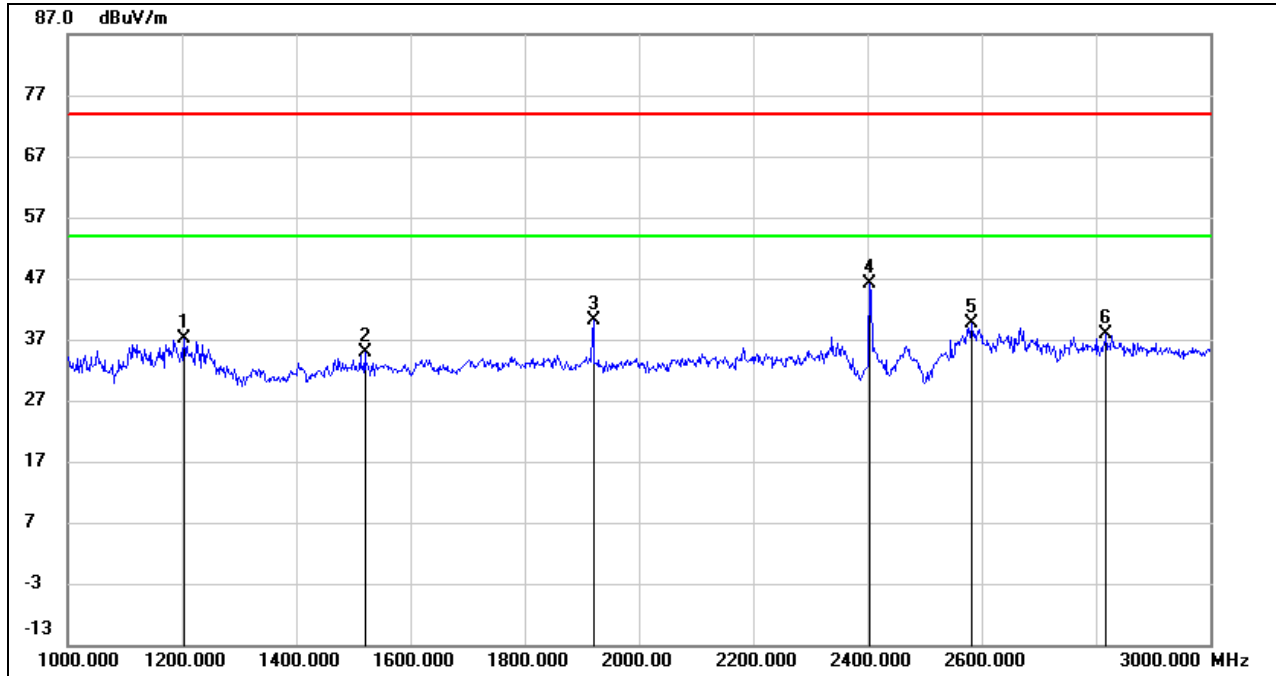

No.	Frequency (MHz)	Reading (dBuV)	Correct (dB/m)	Result (dBuV/m)	Limit (dBuV/m)	Margin (dB)	Remark
1	1204.000	50.99	-13.76	37.23	74.00	-36.77	peak
2	1520.000	47.19	-12.42	34.77	74.00	-39.23	peak
3	1920.000	51.25	-11.02	40.23	74.00	-33.77	peak
4	2405.000	55.11	-9.06	46.05	/	/	Fundamental
5	2582.000	48.40	-8.67	39.73	74.00	-34.27	peak
6	2818.000	45.62	-7.64	37.98	74.00	-36.02	peak

- Note: 1. Measurement = Reading Level + Correct Factor.  
 2. If Peak Result complies with AV limit, AV Result is deemed to comply with AV limit.  
 3. Peak: Peak detector.  
 4. Filter losses were only considered in the spurious frequency bands and the authorized band was not corrected for Band reject filter losses.  
 5. Proper operation of the transmitter prior to adding the filter to the measurement chain.

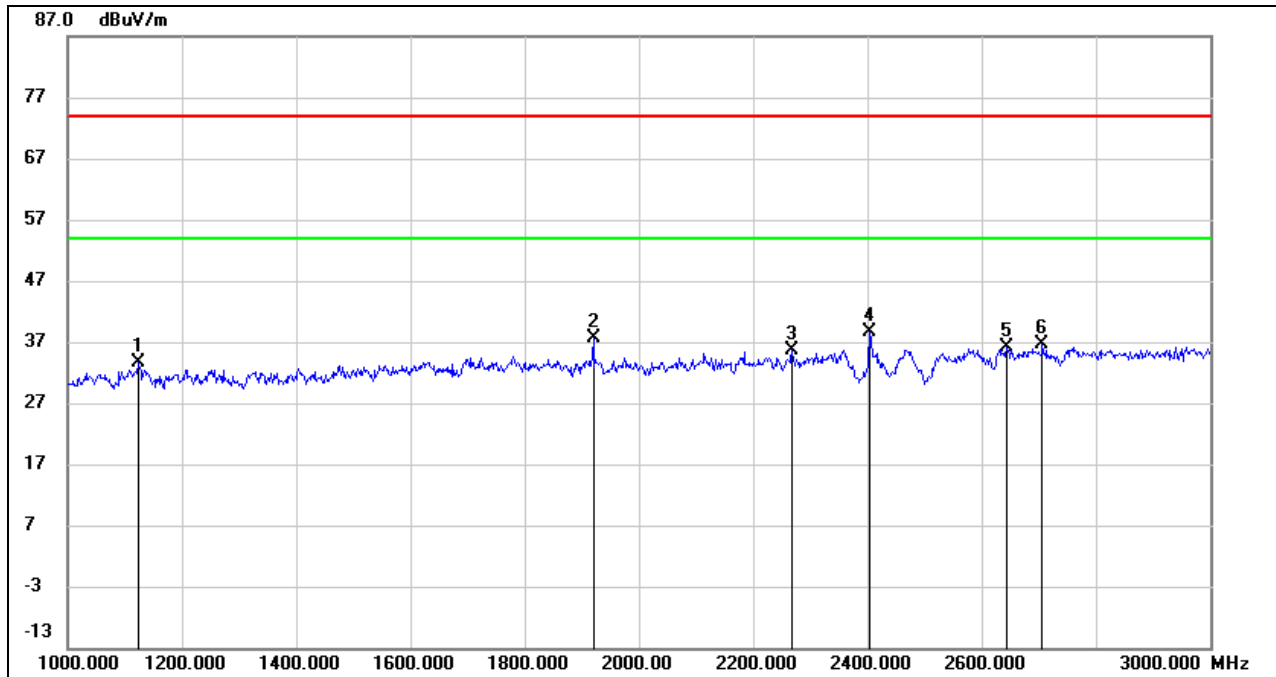
**HARMONICS AND SPURIOUS EMISSIONS (LOW CHANNEL, VERTICAL)**

No.	Frequency (MHz)	Reading (dBuV)	Correct (dB/m)	Result (dBuV/m)	Limit (dBuV/m)	Margin (dB)	Remark
1	1124.000	47.83	-14.27	33.56	74.00	-40.44	peak
2	1920.000	48.62	-11.02	37.60	74.00	-36.40	peak
3	2269.000	45.22	-9.61	35.61	74.00	-38.39	peak
4	2405.000	47.60	-9.06	38.54	/	/	Fundamental
5	2645.000	44.56	-8.43	36.13	74.00	-37.87	peak
6	2706.000	44.65	-8.14	36.51	74.00	-37.49	peak

Note: 1. Measurement = Reading Level + Correct Factor.

2. If Peak Result complies with AV limit, AV Result is deemed to comply with AV limit.

3. Peak: Peak detector.

4. Filter losses were only considered in the spurious frequency bands and the authorized band was not corrected for Band reject filter losses.

5. Proper operation of the transmitter prior to adding the filter to the measurement chain.



**HARMONICS AND SPURIOUS EMISSIONS (MID CHANNEL, HORIZONTAL)**

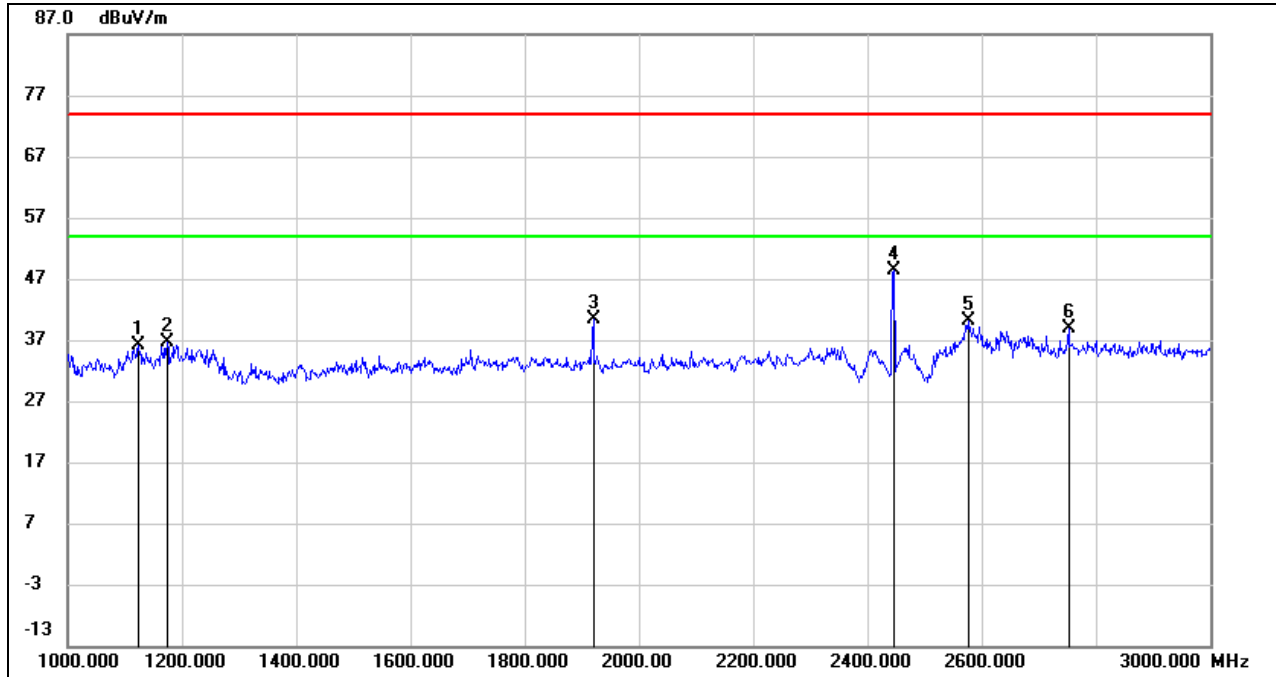

No.	Frequency (MHz)	Reading (dBuV)	Correct (dB/m)	Result (dBuV/m)	Limit (dBuV/m)	Margin (dB)	Remark
1	1125.000	50.30	-14.26	36.04	74.00	-37.96	peak
2	1174.000	50.55	-13.95	36.60	74.00	-37.40	peak
3	1920.000	51.34	-11.02	40.32	74.00	-33.68	peak
4	2445.000	57.43	-8.96	48.47	/	/	Fundamental
5	2577.000	48.80	-8.69	40.11	74.00	-33.89	peak
6	2752.000	46.79	-7.93	38.86	74.00	-35.14	peak

- Note: 1. Measurement = Reading Level + Correct Factor.  
 2. If Peak Result complies with AV limit, AV Result is deemed to comply with AV limit.  
 3. Peak: Peak detector.  
 4. Filter losses were only considered in the spurious frequency bands and the authorized band was not corrected for Band reject filter losses.  
 5. Proper operation of the transmitter prior to adding the filter to the measurement chain.

**HARMONICS AND SPURIOUS EMISSIONS (MID CHANNEL, VERTICAL)**

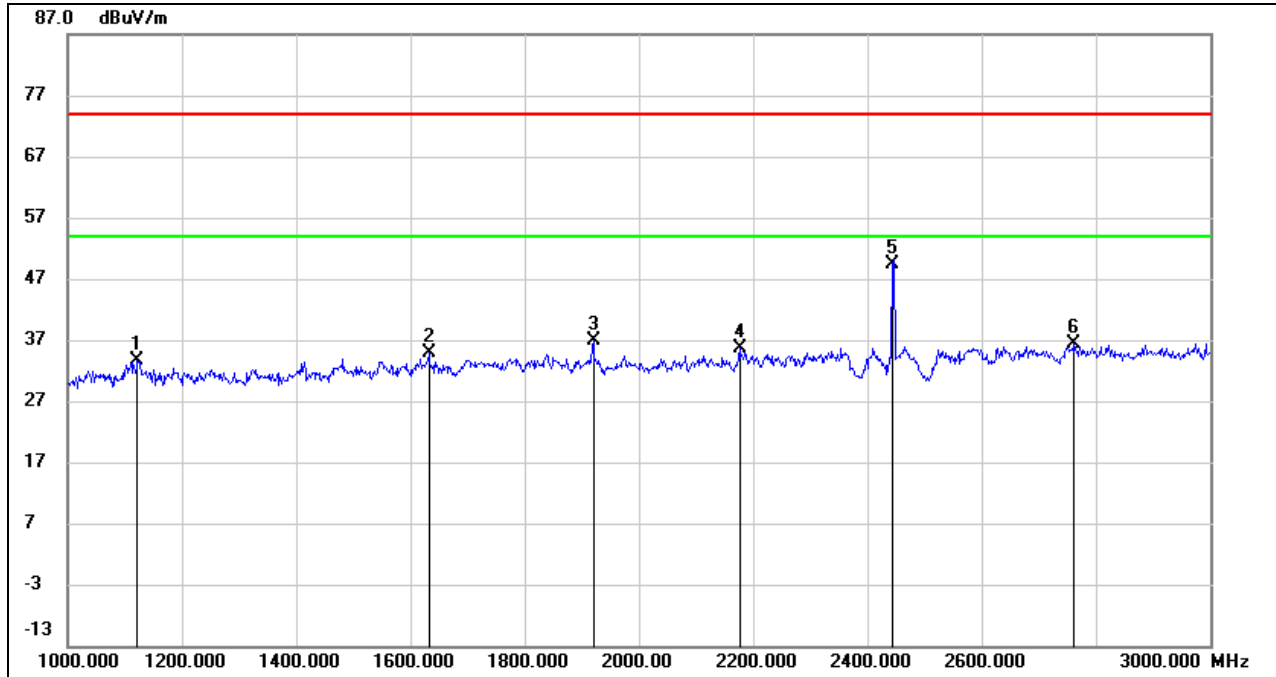

No.	Frequency (MHz)	Reading (dBuV)	Correct (dB/m)	Result (dBuV/m)	Limit (dBuV/m)	Margin (dB)	Remark
1	1122.000	47.82	-14.29	33.53	74.00	-40.47	peak
2	1632.000	46.61	-11.79	34.82	74.00	-39.18	peak
3	1920.000	47.87	-11.02	36.85	74.00	-37.15	peak
4	2177.000	45.60	-10.04	35.56	74.00	-38.44	peak
5	2445.000	58.42	-8.95	49.47	/	/	Fundamental
6	2762.000	44.28	-7.88	36.40	74.00	-37.60	peak

- Note: 1. Measurement = Reading Level + Correct Factor.  
 2. If Peak Result complies with AV limit, AV Result is deemed to comply with AV limit.  
 3. Peak: Peak detector.  
 4. Filter losses were only considered in the spurious frequency bands and the authorized band was not corrected for Band reject filter losses.  
 5. Proper operation of the transmitter prior to adding the filter to the measurement chain.

**HARMONICS AND SPURIOUS EMISSIONS (HIGH CHANNEL, HORIZONTAL)**

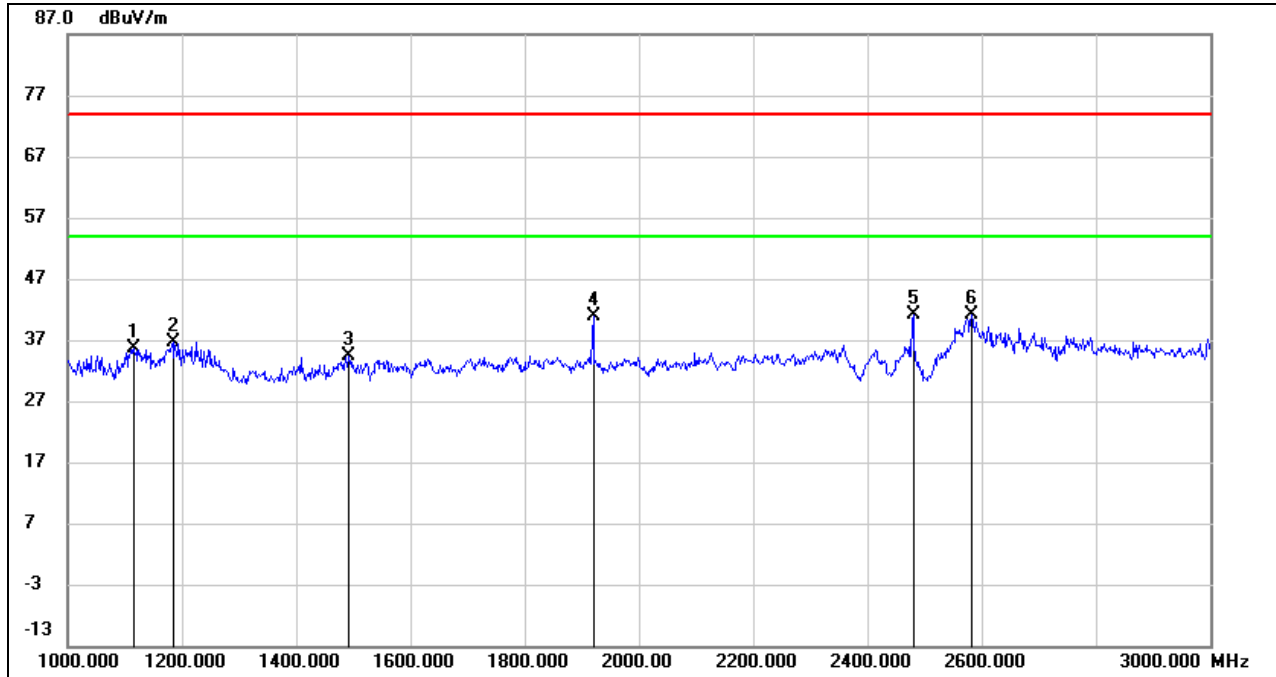

No.	Frequency (MHz)	Reading (dBuV)	Correct (dB/m)	Result (dBuV/m)	Limit (dBuV/m)	Margin (dB)	Remark
1	1116.000	49.86	-14.32	35.54	74.00	-38.46	peak
2	1184.000	50.58	-13.87	36.71	74.00	-37.29	peak
3	1493.000	46.83	-12.57	34.26	74.00	-39.74	peak
4	1920.000	51.82	-11.02	40.80	74.00	-33.20	peak
5	2480.000	50.07	-8.87	41.20	/	/	Fundamental
6	2583.000	49.79	-8.67	41.12	74.00	-32.88	peak

- Note: 1. Measurement = Reading Level + Correct Factor.  
 2. If Peak Result complies with AV limit, AV Result is deemed to comply with AV limit.  
 3. Peak: Peak detector.  
 4. Filter losses were only considered in the spurious frequency bands and the authorized band was not corrected for Band reject filter losses.  
 5. Proper operation of the transmitter prior to adding the filter to the measurement chain.

**HARMONICS AND SPURIOUS EMISSIONS (HIGH CHANNEL, VERTICAL)**

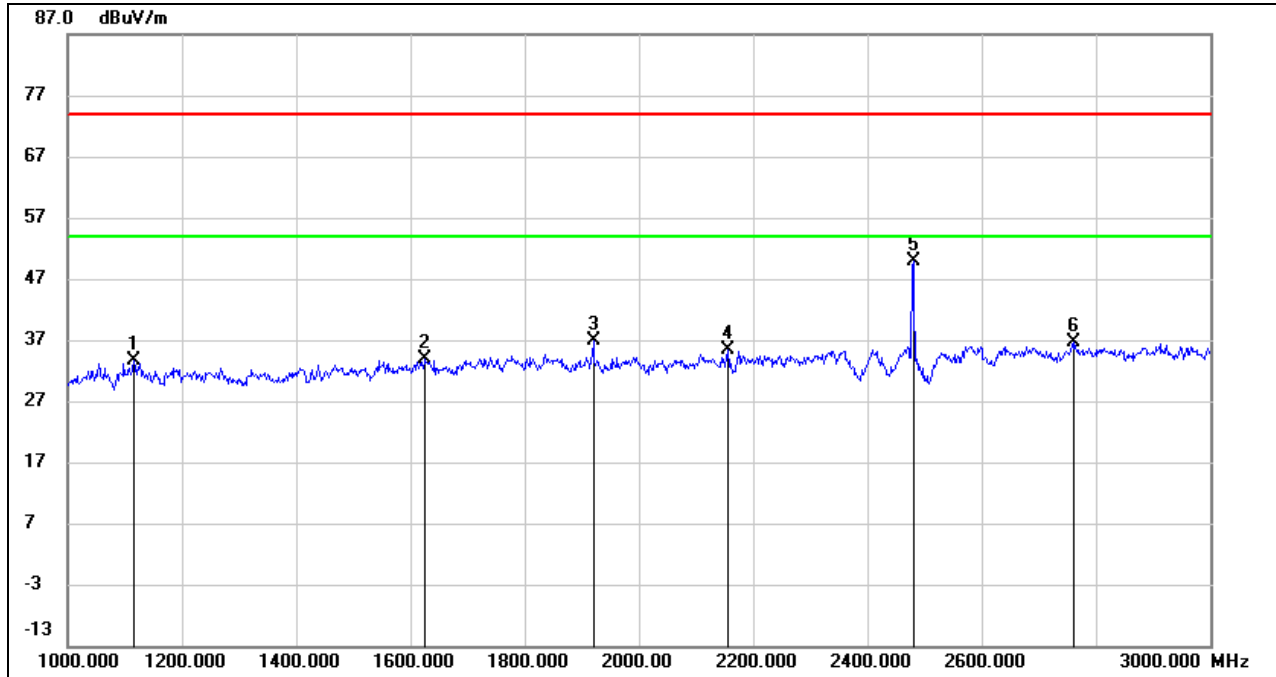

No.	Frequency (MHz)	Reading (dBuV)	Correct (dB/m)	Result (dBuV/m)	Limit (dBuV/m)	Margin (dB)	Remark
1	1116.000	47.90	-14.32	33.58	74.00	-40.42	peak
2	1626.000	45.67	-11.84	33.83	74.00	-40.17	peak
3	1920.000	47.94	-11.02	36.92	74.00	-37.08	peak
4	2156.000	45.63	-10.17	35.46	74.00	-38.54	peak
5	2480.000	58.75	-8.87	49.88	/	/	Fundamental
6	2761.000	44.52	-7.88	36.64	74.00	-37.36	peak

- Note: 1. Peak Result = Reading Level + Correct Factor.  
 2. If Peak Result complies with AV limit, AV Result is deemed to comply with AV limit.  
 3. Peak: Peak detector.  
 4. Filter losses were only considered in then spurious frequency bands and the authorized band was not corrected for BRF losses.  
 5. Proper operation of the transmitter prior to adding the filter to the measurement chain.

### 8.3. SPURIOUS EMISSIONS (3 GHz ~ 18 GHz)

#### HARMONICS AND SPURIOUS EMISSIONS (LOW CHANNEL, HORIZONTAL)

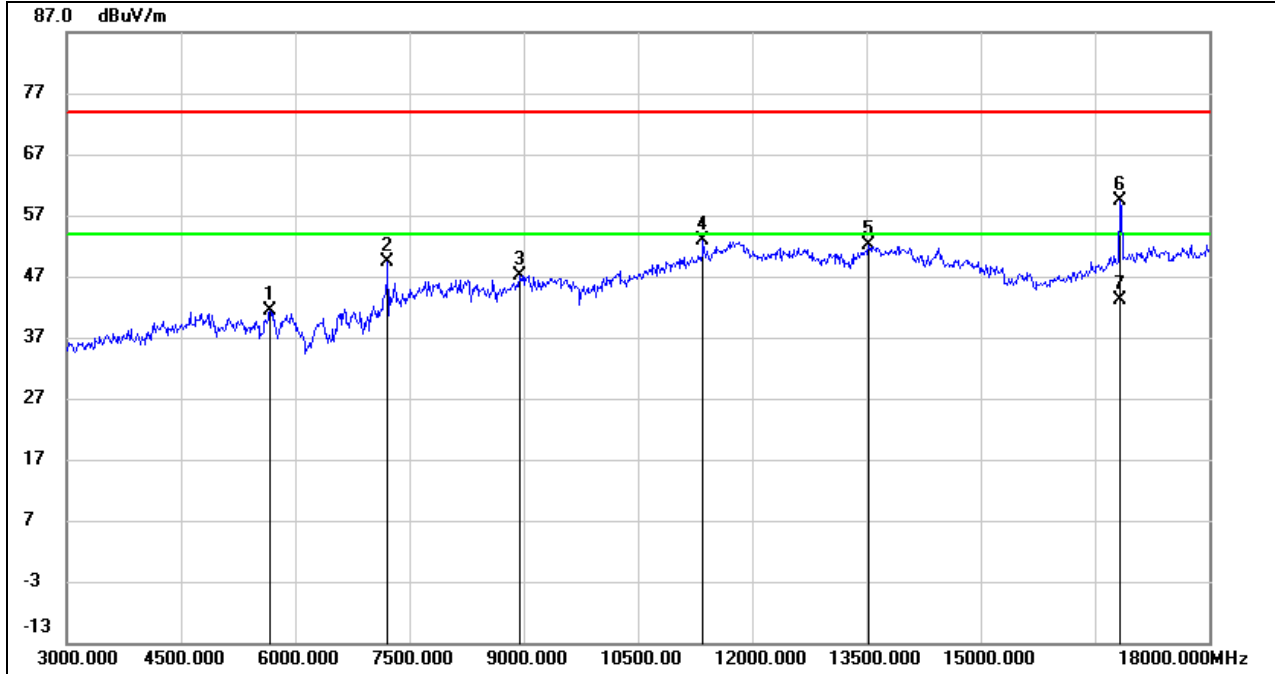

No.	Frequency (MHz)	Reading (dBuV)	Correct (dB/m)	Result (dBuV/m)	Limit (dBuV/m)	Margin (dB)	Remark
1	5670.000	39.87	1.44	41.31	74.00	-32.69	peak
2	7215.000	43.28	6.16	49.44	74.00	-24.56	peak
3	8940.000	37.77	9.47	47.24	74.00	-26.76	peak
4	11355.000	37.24	15.62	52.86	74.00	-21.14	peak
5	13530.000	33.80	18.40	52.20	74.00	-21.80	peak
6	16837.500	41.36	17.90	59.26	74.00	-14.74	peak
7	16837.500	25.23	17.90	43.13	54.00	-10.87	AVG

- Note:
1. Peak Result = Reading Level + Correct Factor.
  2. If Peak Result complies with AV limit, AV Result is deemed to comply with AV limit.
  3. Peak: Peak detector.
  4. AVG:  $VBW=1/Ton$ , where: Ton is the transmitting duration.
  5. For the transmitting duration, please refer to clause 7.1.
  6. Filter losses were only considered in the spurious frequency bands and the authorized band was not corrected for High Pass Filter losses.
  7. Proper operation of the transmitter prior to adding the filter to the measurement chain.
  8. \*-indicates frequency out of 47CFR Pt 15 / ISED RSS-Restricted band.

**HARMONICS AND SPURIOUS EMISSIONS (LOW CHANNEL, VERTICAL)**

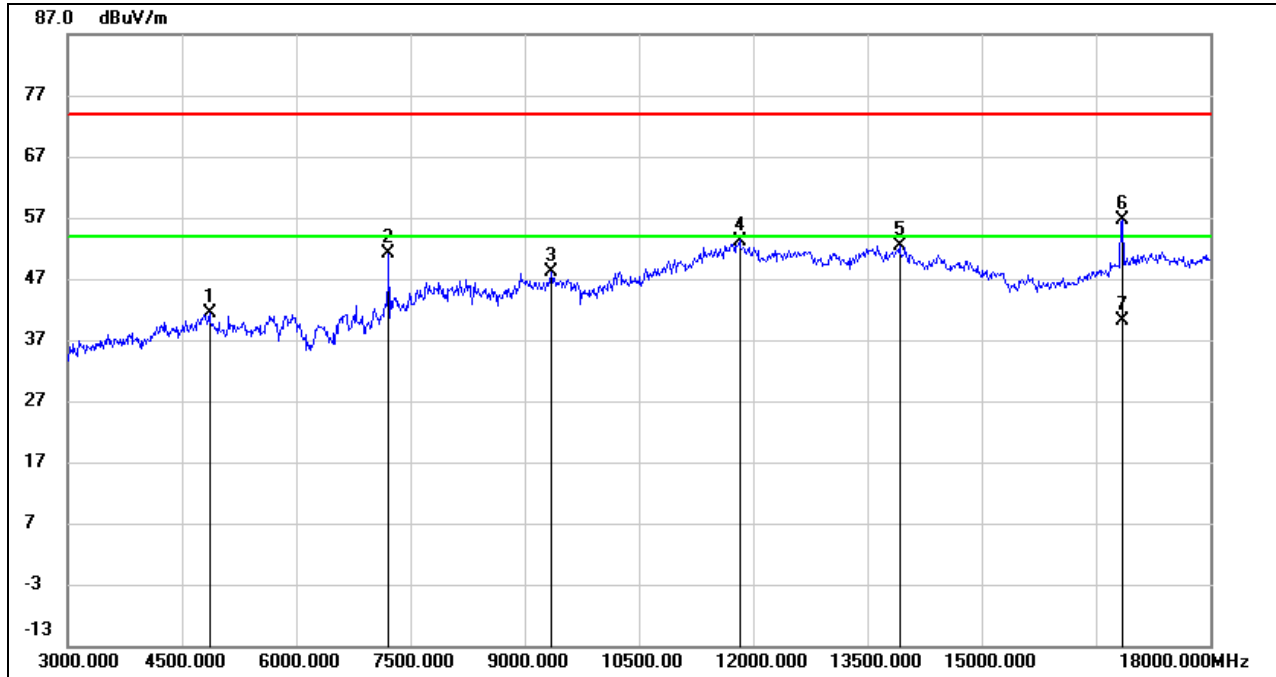

No.	Frequency (MHz)	Reading (dBuV)	Correct (dB/m)	Result (dBuV/m)	Limit (dBuV/m)	Margin (dB)	Remark
1	4860.000	42.05	-0.61	41.44	74.00	-32.56	peak
2	7215.000	44.89	6.16	51.05	74.00	-22.95	peak
3	9352.500	38.19	9.84	48.03	74.00	-25.97	peak
4	11827.500	35.95	17.30	53.25	74.00	-20.75	peak
5	13920.000	33.85	18.64	52.49	74.00	-21.51	peak
6	16845.000	38.75	17.93	56.68	74.00	-17.32	peak
7	16845.000	22.30	17.93	40.23	54.00	-13.77	AVG

- Note:
1. Peak Result = Reading Level + Correct Factor.
  2. If Peak Result complies with AV limit, AV Result is deemed to comply with AV limit.
  3. Peak: Peak detector.
  4. AVG:  $VBW=1/Ton$ , where: Ton is the transmitting duration.
  5. For the transmitting duration, please refer to clause 7.1.
  6. Filter losses were only considered in the spurious frequency bands and the authorized band was not corrected for High Pass Filter losses.
  7. Proper operation of the transmitter prior to adding the filter to the measurement chain.
  8. \*-indicates frequency out of 47CFR Pt 15 / ISED RSS-Restricted band.

**HARMONICS AND SPURIOUS EMISSIONS (MID CHANNEL, HORIZONTAL)**

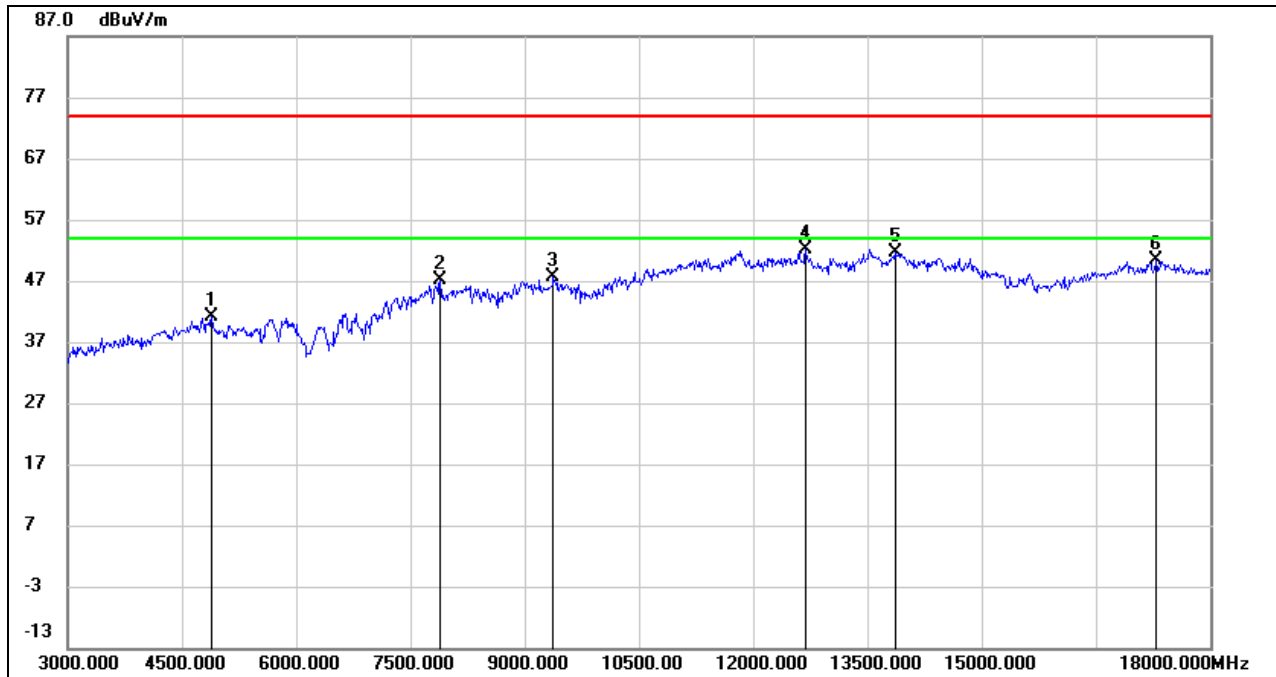

No.	Frequency (MHz)	Reading (dBuV)	Correct (dB/m)	Result (dBuV/m)	Limit (dBuV/m)	Margin (dB)	Remark
1	4890.000	41.70	-0.58	41.12	74.00	-32.88	peak
2	7890.000	39.70	7.36	47.06	74.00	-26.94	peak
3	9382.500	37.64	10.03	47.67	74.00	-26.33	peak
4	12697.500	35.16	16.85	52.01	74.00	-21.99	peak
5	13867.500	32.85	18.70	51.55	74.00	-22.45	peak
6	17295.000	30.52	19.79	50.31	74.00	-23.69	peak

- Note:
1. Peak Result = Reading Level + Correct Factor.
  2. If Peak Result complies with AV limit, AV Result is deemed to comply with AV limit.
  3. Peak: Peak detector.
  4. AVG:  $VBW=1/Ton$ , where: Ton is the transmitting duration.
  5. For the transmitting duration, please refer to clause 7.1.
  6. Filter losses were only considered in the spurious frequency bands and the authorized band was not corrected for High Pass Filter losses.
  7. Proper operation of the transmitter prior to adding the filter to the measurement chain.
  8. \*-indicates frequency out of 47CFR Pt 15 / ISED RSS-Restricted band.

**HARMONICS AND SPURIOUS EMISSIONS (MID CHANNEL, VERTICAL)**

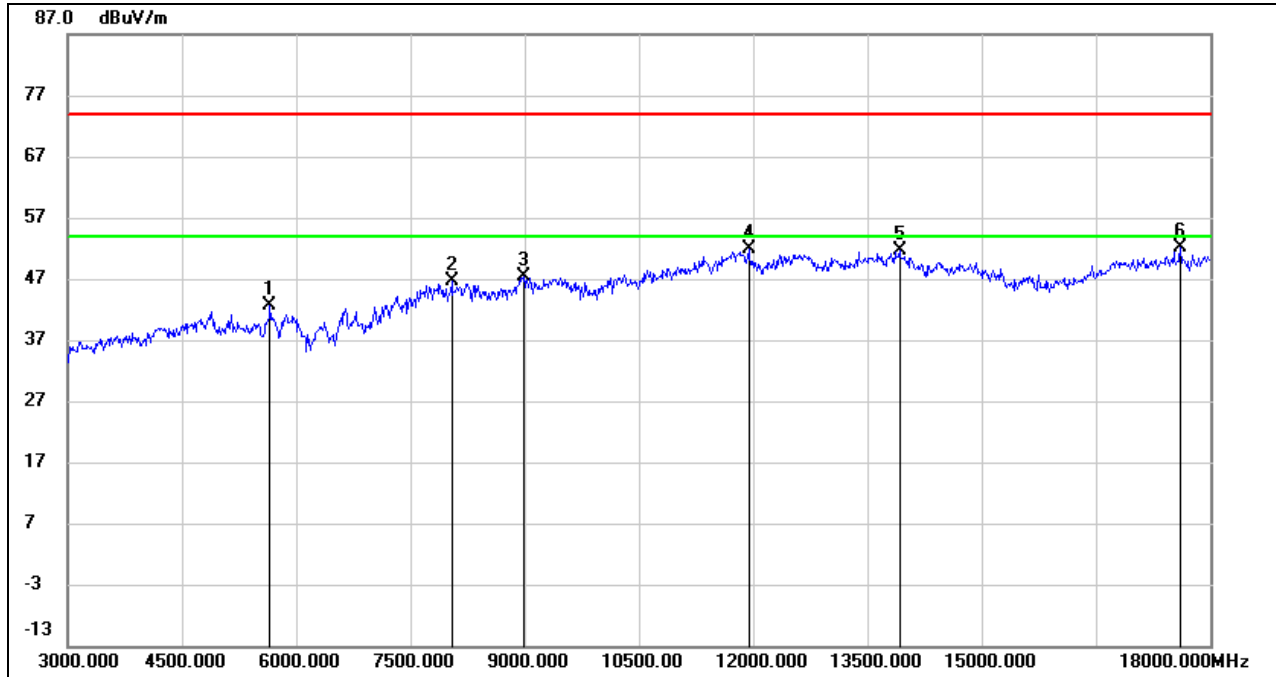

No.	Frequency (MHz)	Reading (dBuV)	Correct (dB/m)	Result (dBuV/m)	Limit (dBuV/m)	Margin (dB)	Remark
1	5655.000	41.08	1.44	42.52	74.00	-31.48	peak
2	8047.500	39.10	7.45	46.55	74.00	-27.45	peak
3	8985.000	37.42	9.96	47.38	74.00	-26.62	peak
4	11940.000	34.65	17.12	51.77	74.00	-22.23	peak
5	13920.000	32.99	18.64	51.63	74.00	-22.37	peak
6	17610.000	31.28	20.85	52.13	74.00	-21.87	peak

- Note:
1. Peak Result = Reading Level + Correct Factor.
  2. If Peak Result complies with AV limit, AV Result is deemed to comply with AV limit.
  3. Peak: Peak detector.
  4. AVG:  $VBW=1/Ton$ , where: Ton is the transmitting duration.
  5. For the transmitting duration, please refer to clause 7.1.
  6. Filter losses were only considered in the spurious frequency bands and the authorized band was not corrected for High Pass Filter losses.
  7. Proper operation of the transmitter prior to adding the filter to the measurement chain.
  8. \*-indicates frequency out of 47CFR Pt 15 / ISED RSS-Restricted band.





**HARMONICS AND SPURIOUS EMISSIONS (HIGH CHANNEL, HORIZONTAL)**

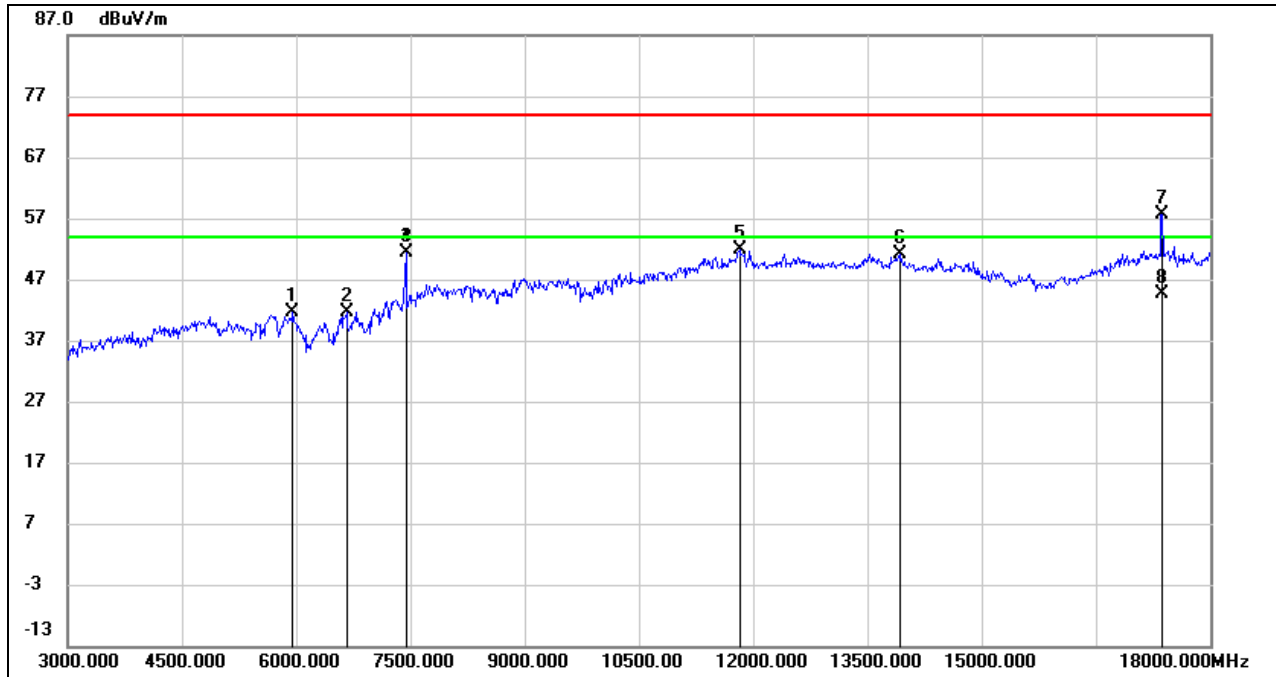

No.	Frequency (MHz)	Reading (dBuV)	Correct (dB/m)	Result (dBuV/m)	Limit (dBuV/m)	Margin (dB)	Remark
1	5955.000	39.52	2.04	41.56	74.00	-32.44	peak
2	6660.000	37.10	4.52	41.62	74.00	-32.38	peak
3	7440.000	44.43	6.95	51.38	74.00	-22.62	peak
4	7440.000	44.43	6.95	51.38	74.00	-22.62	peak
5	11820.000	34.44	17.32	51.76	74.00	-22.24	peak
6	13927.500	32.47	18.63	51.10	74.00	-22.90	peak
7	17370.000	37.87	19.82	57.69	74.00	-16.31	peak
8	17370.000	24.80	19.82	44.62	54.00	-9.38	AVG

- Note: 1. Peak Result = Reading Level + Correct Factor.  
 2. If Peak Result complies with AV limit, AV Result is deemed to comply with AV limit.  
 3. Peak: Peak detector.  
 4. AVG:  $VBW=1/Ton$ , where: Ton is the transmitting duration.  
 5. For the transmitting duration, please refer to clause 7.1.  
 6. Filter losses were only considered in the spurious frequency bands and the authorized band was not corrected for High Pass Filter losses.  
 7. Proper operation of the transmitter prior to adding the filter to the measurement chain.  
 8. \*-indicates frequency out of 47CFR Pt 15 / ISSED RSS-Restricted band.

**HARMONICS AND SPURIOUS EMISSIONS (HIGH CHANNEL, VERTICAL)**

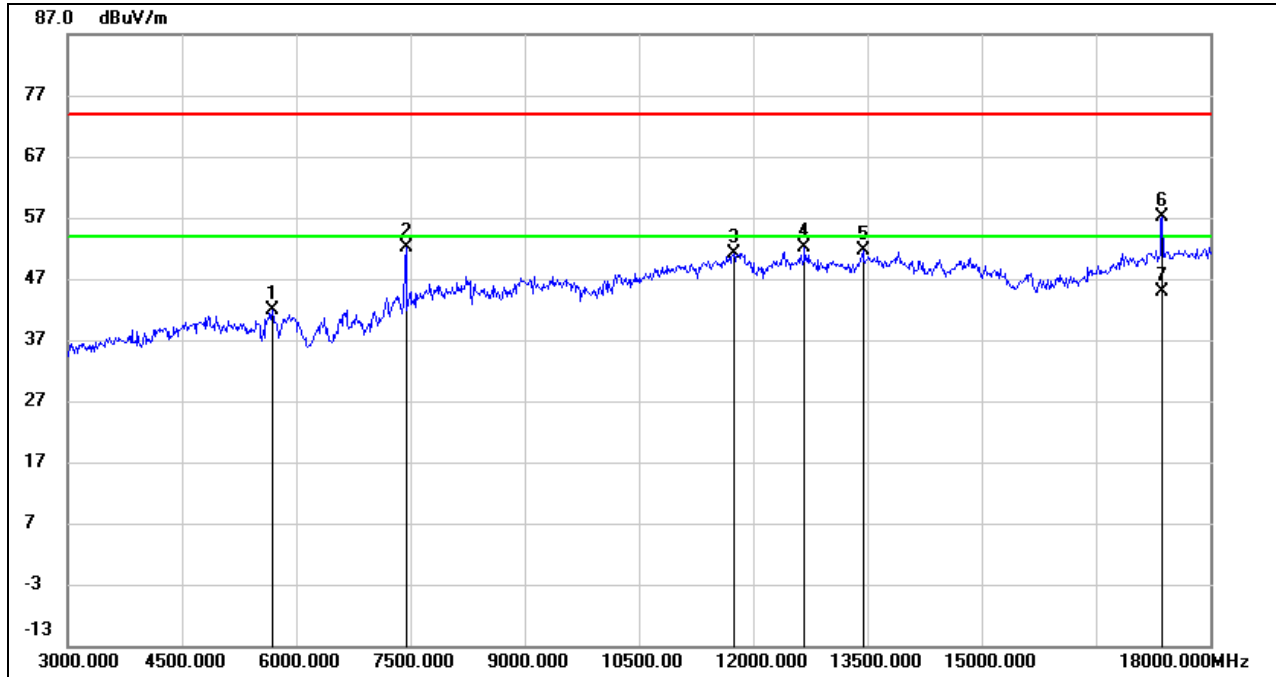

No.	Frequency (MHz)	Reading (dBuV)	Correct (dB/m)	Result (dBuV/m)	Limit (dBuV/m)	Margin (dB)	Remark
1	5685.000	40.32	1.44	41.76	74.00	-32.24	peak
2	7440.000	45.27	6.95	52.22	74.00	-21.78	peak
3	11745.000	34.18	17.07	51.25	74.00	-22.75	peak
4	12682.500	35.24	16.81	52.05	74.00	-21.95	peak
5	13440.000	33.31	18.29	51.60	74.00	-22.40	peak
6	17370.000	37.20	19.82	57.02	74.00	-16.98	peak
7	17370.000	25.03	19.82	44.85	54.00	-9.15	AVG

- Note:
1. Peak Result = Reading Level + Correct Factor.
  2. If Peak Result complies with AV limit, AV Result is deemed to comply with AV limit.
  3. Peak: Peak detector.
  4. AVG:  $VBW=1/Ton$ , where: Ton is the transmitting duration.
  5. For the transmitting duration, please refer to clause 7.1.
  6. Filter losses were only considered in the spurious frequency bands and the authorized band was not corrected for High Pass Filter losses.
  7. Proper operation of the transmitter prior to adding the filter to the measurement chain.
  8. \*-indicates frequency out of 47CFR Pt 15 / ISED RSS-Restricted band.

### 8.4. SPURIOUS EMISSIONS (18 GHz ~ 26 GHz)

#### SPURIOUS EMISSIONS (LOW CHANNEL, WORST-CASE CONFIGURATION, HORIZONTAL)

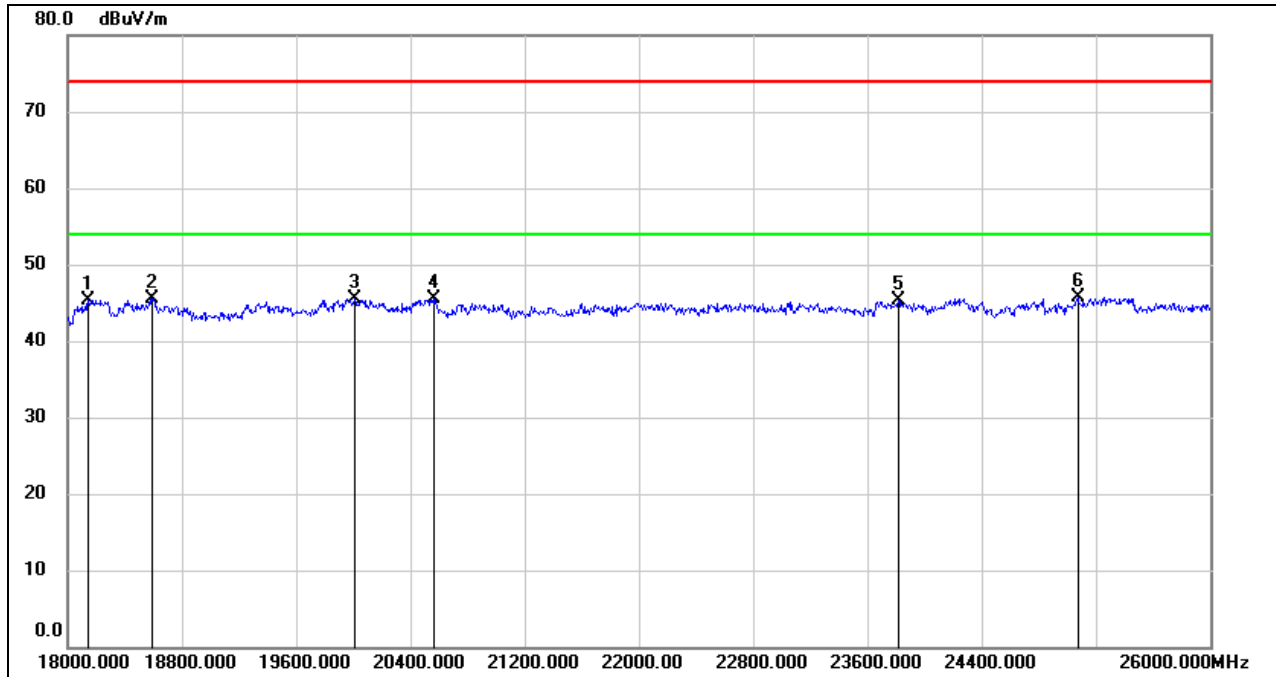

No.	Frequency (MHz)	Reading (dBuV)	Correct (dB/m)	Result (dBuV/m)	Limit (dBuV/m)	Margin (dB)	Remark
1	18144.000	50.77	-5.48	45.29	74.00	-28.71	peak
2	18592.000	50.75	-5.31	45.44	74.00	-28.56	peak
3	20008.000	51.03	-5.46	45.57	74.00	-28.43	peak
4	20560.000	50.73	-5.30	45.43	74.00	-28.57	peak
5	23816.000	48.39	-3.08	45.31	74.00	-28.69	peak
6	25072.000	47.67	-1.97	45.70	74.00	-28.30	peak

- Note: 1. Peak Result = Reading Level + Correct Factor.  
 2. If Peak Result complies with AV limit, AV Result is deemed to comply with AV limit.  
 3. Peak: Peak detector.



**SPURIOUS EMISSIONS (LOW CHANNEL, WORST-CASE CONFIGURATION, VERTICAL)**

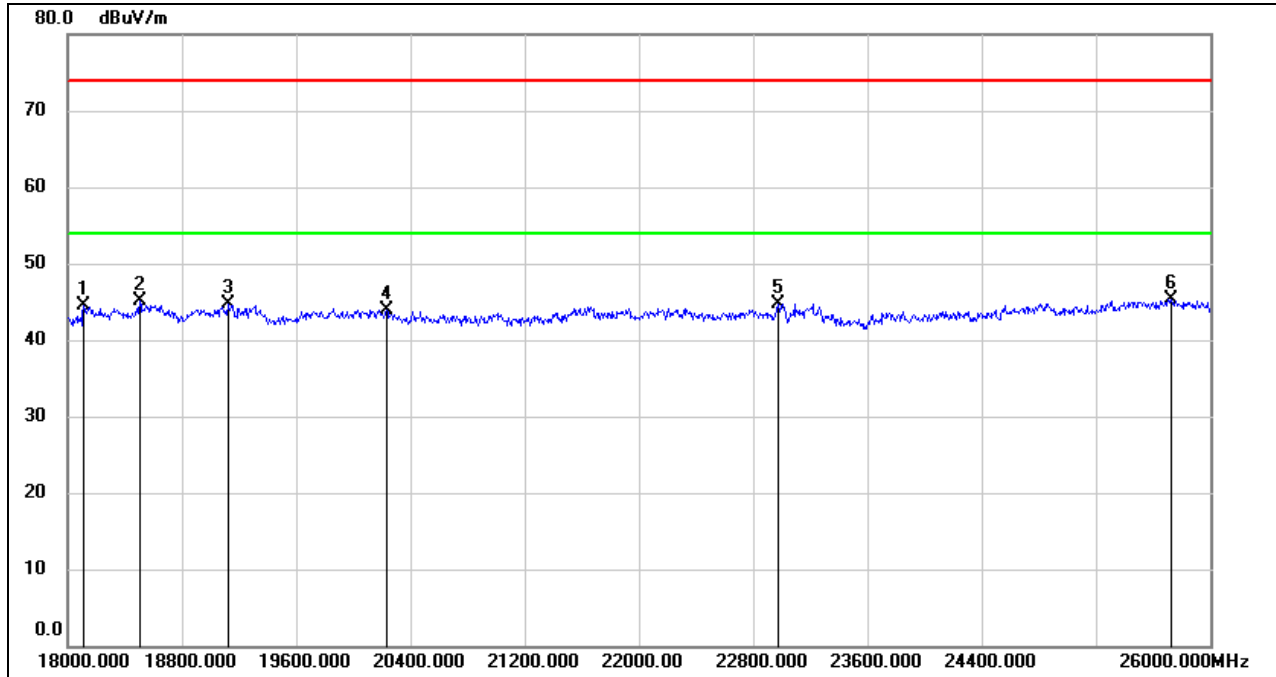

No.	Frequency (MHz)	Reading (dBuV)	Correct (dB/m)	Result (dBuV/m)	Limit (dBuV/m)	Margin (dB)	Remark
1	18112.000	49.96	-5.47	44.49	74.00	-29.51	peak
2	18504.000	50.27	-5.25	45.02	74.00	-28.98	peak
3	19120.000	50.12	-5.38	44.74	74.00	-29.26	peak
4	20232.000	49.42	-5.60	43.82	74.00	-30.18	peak
5	22976.000	48.26	-3.46	44.80	74.00	-29.20	peak
6	25728.000	46.11	-0.72	45.39	74.00	-28.61	peak

- Note: 1. Peak Result = Reading Level + Correct Factor.  
 2. If Peak Result complies with AV limit, AV Result is deemed to comply with AV limit.  
 3. Peak: Peak detector.

Note: All the channels have been tested, only the worst data was recorded in the report.

### 8.5. SPURIOUS EMISSIONS (30 MHz ~ 1 GHz)

#### SPURIOUS EMISSIONS (LOW CHANNEL, WORST-CASE CONFIGURATION, HORIZONTAL)

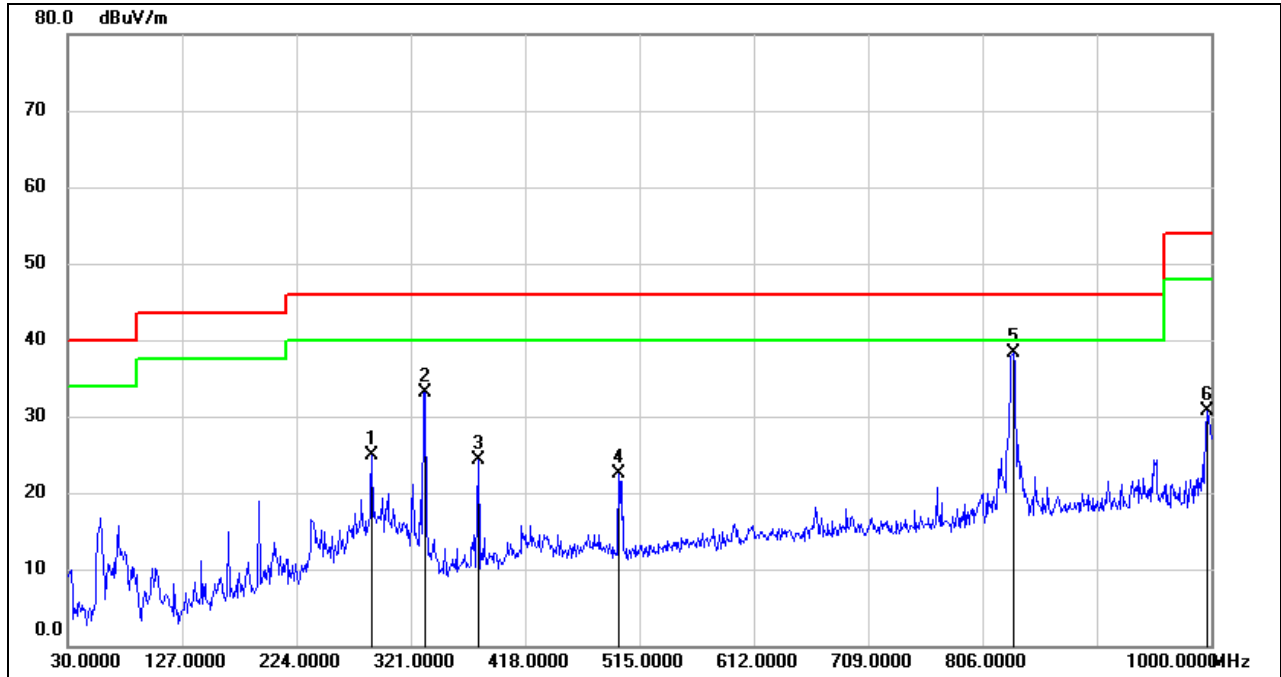

No.	Frequency (MHz)	Reading (dBuV)	Correct (dB/m)	Result (dBuV/m)	Limit (dBuV/m)	Margin (dB)	Remark
1	288.0200	40.90	-16.06	24.84	46.00	-21.16	QP
2	333.6099	47.76	-14.59	33.17	46.00	-12.83	QP
3	378.2300	38.10	-13.70	24.40	46.00	-21.60	QP
4	497.5400	33.94	-11.52	22.42	46.00	-23.58	QP
5	832.1900	44.98	-6.63	38.35	46.00	-7.65	QP
6	997.0900	34.81	-4.18	30.63	54.00	-23.37	QP

- Note: 1. Result Level = Read Level + Correct Factor.  
 2. If Peak Result complies with QP limit, QP Result is deemed to comply with QP limit.  
 3. Test setup: RBW: 120 kHz, VBW: 300 kHz, Sweep time: auto.

**SPURIOUS EMISSIONS (LOW CHANNEL, WORST-CASE CONFIGURATION, VERTICAL)**

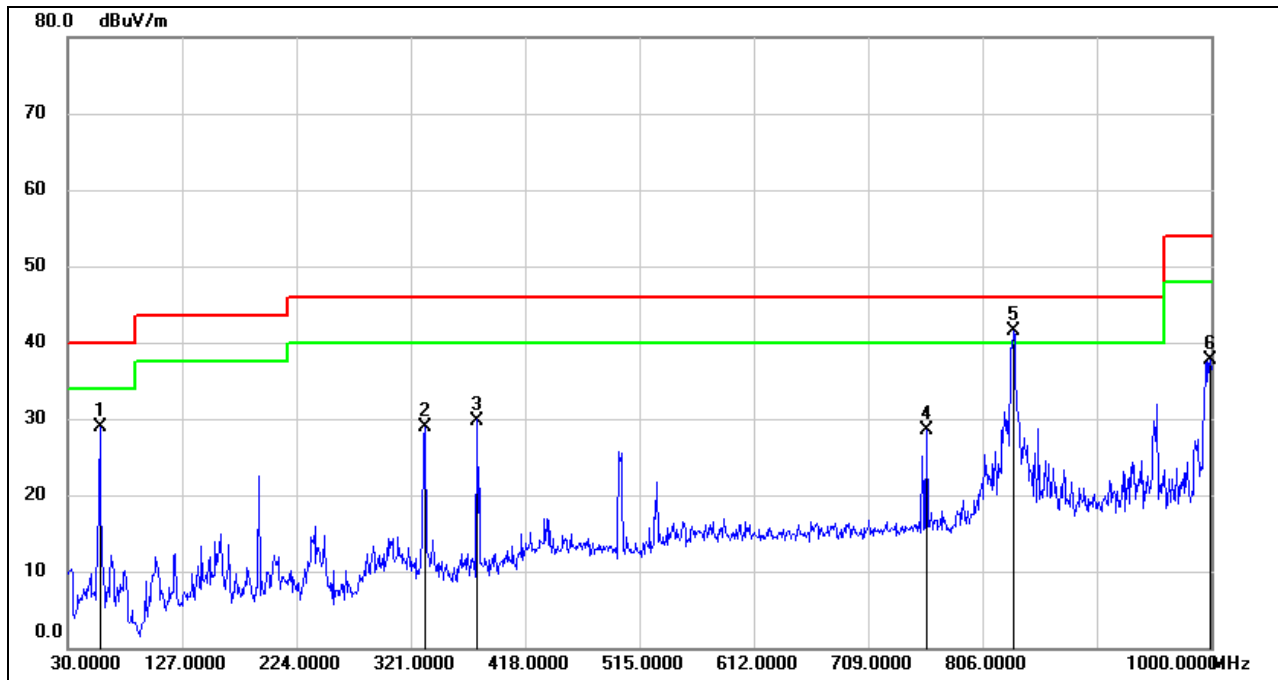

No.	Frequency (MHz)	Reading (dBuV)	Correct (dB/m)	Result (dBuV/m)	Limit (dBuV/m)	Margin (dB)	Remark
1	57.1600	49.56	-20.58	28.98	40.00	-11.02	QP
2	332.6400	43.46	-14.62	28.84	46.00	-17.16	QP
3	377.2600	43.52	-13.72	29.80	46.00	-16.20	QP
4	758.4699	36.30	-7.74	28.56	46.00	-17.44	QP
5	832.1900	48.16	-6.63	41.53	46.00	-4.47	QP
6	999.0300	41.94	-4.15	37.79	54.00	-16.21	QP

- Note: 1. Result Level = Read Level + Correct Factor.  
 2. If Peak Result complies with QP limit, QP Result is deemed to comply with QP limit.  
 3. Test setup: RBW: 120 kHz, VBW: 300 kHz, Sweep time: auto

Note: All the channels have been tested, only the worst data was recorded in the report.

### 8.6. SPURIOUS EMISSIONS BELOW 30 MHz

**SPURIOUS EMISSIONS (LOW CHANNEL, LOOP ANTENNA FACE ON TO THE EUT, WORST-CASE CONFIGURATION)**

**9 kHz~ 150 kHz**

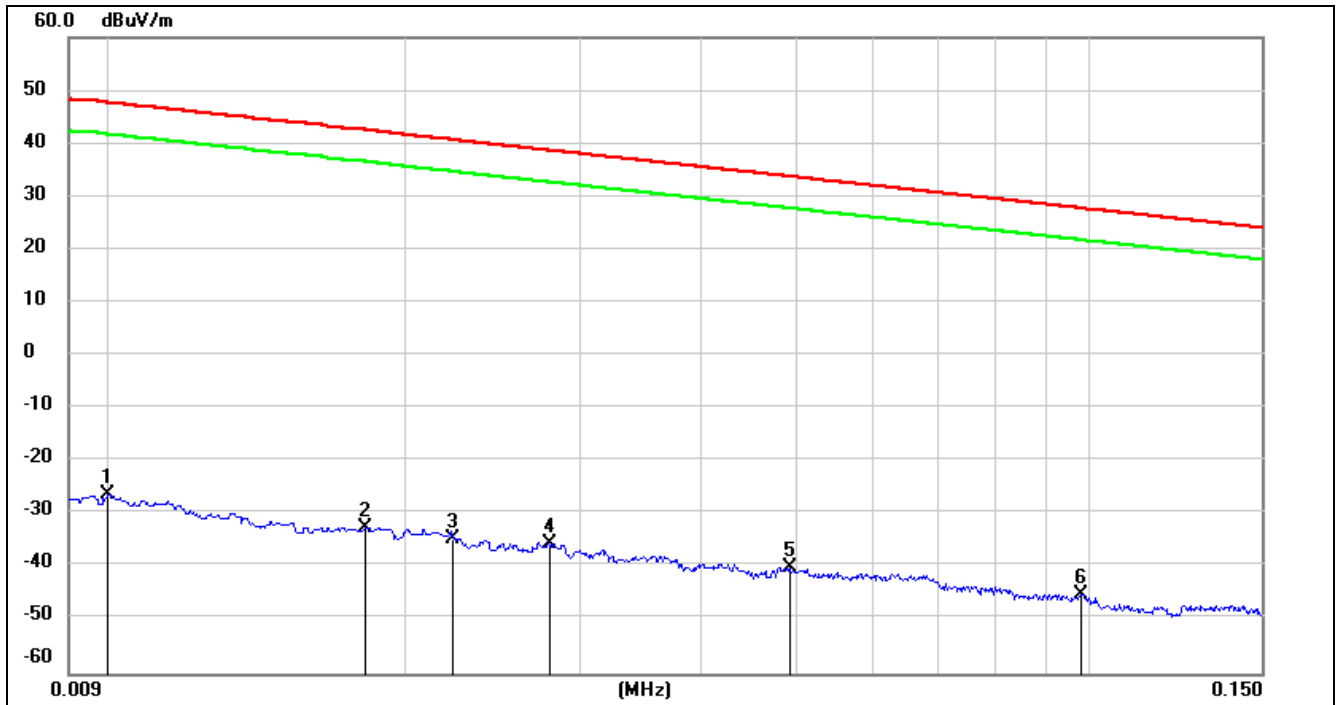

No.	Frequency (MHz)	Reading (dBuV)	Correct (dB/m)	FCC Result (dBuV/m)	FCC Limit (dBuV/m)	ISED Result (dBuA/m)	ISED Limit (dBuA/m)	Margin (dB)	Remark
1	0.0100	75.22	-101.40	-26.18	47.6	-77.68	-3.90	-73.78	peak
2	0.0181	68.85	-101.36	-32.51	42.45	-84.01	-9.05	-74.96	peak
3	0.0223	66.79	-101.35	-34.56	40.63	-86.06	-10.87	-75.19	peak
4	0.0280	65.79	-101.38	-35.59	38.66	-87.09	-12.84	-74.25	peak
5	0.0492	61.55	-101.47	-39.92	33.76	-91.42	-17.74	-73.68	peak
6	0.0981	56.77	-101.78	-45.01	27.77	-96.51	-23.73	-72.78	peak

Note: 1. Measurement = Reading Level + Correct Factor (dBuA/m= dBuV/m- 20Log10[120π] = dBuV/m- 51.5).

2. If Peak Result complies with AV and QP limit, AV and QP Result are deemed to comply with AV limit.

3. All 3 polarizations (Horizontal, Face-on and Face-off) of the loop antenna had been tested, but only the worst data recorded in the report.



**150 kHz ~ 490 kHz**

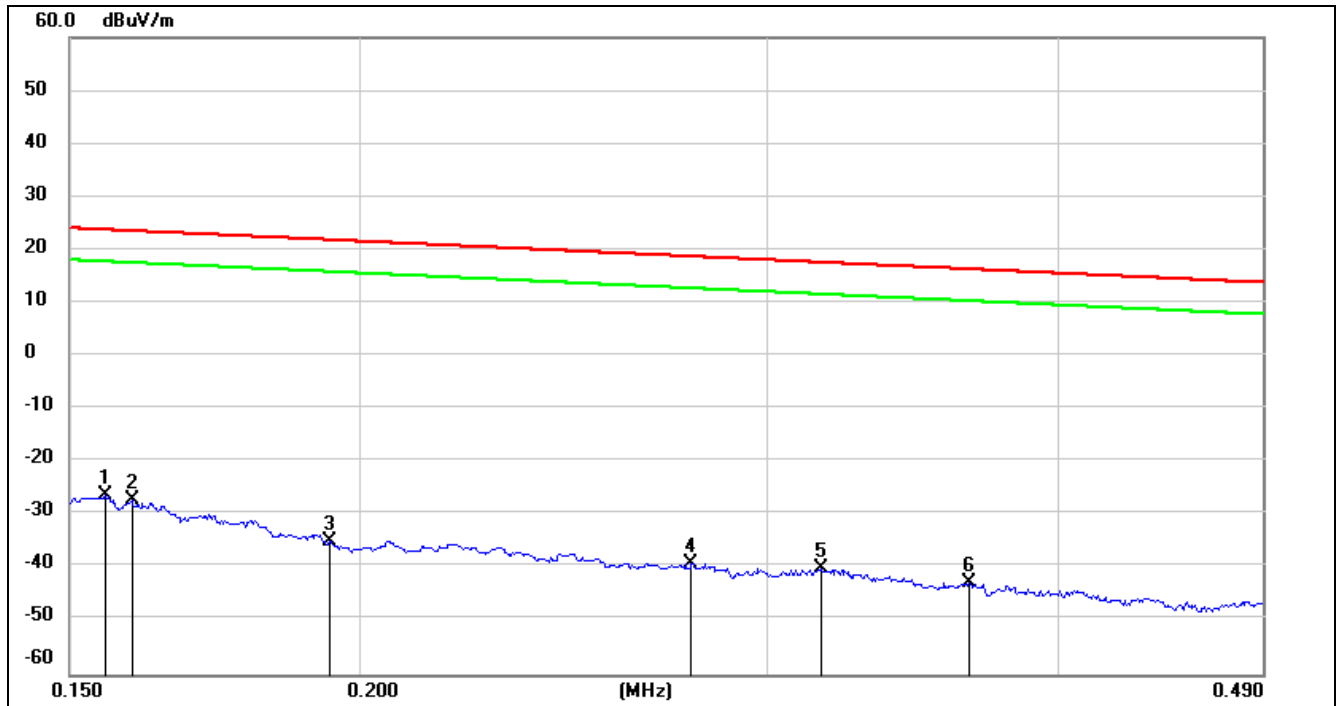

No.	Frequency (MHz)	Reading (dBuV)	Correct (dB/m)	FCC Result (dBuV/m)	FCC Limit (dBuV/m)	ISED Result (dBuA/m)	ISED Limit (dBuA/m)	Margin (dB)	Remark
1	0.1554	75.27	-101.65	-26.38	23.77	-77.88	-27.73	-50.15	peak
2	0.1595	74.36	-101.65	-27.29	23.55	-78.79	-27.95	-50.84	peak
3	0.1942	66.81	-101.70	-34.89	21.84	-86.39	-29.66	-56.73	peak
4	0.2782	62.79	-101.83	-39.04	18.71	-90.54	-32.79	-57.75	peak
5	0.3163	61.70	-101.87	-40.17	17.6	-91.67	-33.90	-57.77	peak
6	0.3662	59.08	-101.93	-42.85	16.33	-94.35	-35.17	-59.18	peak

Note: 1. Measurement = Reading Level + Correct Factor (dBuA/m= dBuV/m- 20Log10[120π] = dBuV/m- 51.5).

2. If Peak Result complies with AV and QP limit, AV and QP Result are deemed to comply with AV limit.

3. All 3 polarizations (Horizontal, Face-on and Face-off) of the loop antenna had been tested, but only the worst data recorded in the report.



**490 kHz ~ 30 MHz**

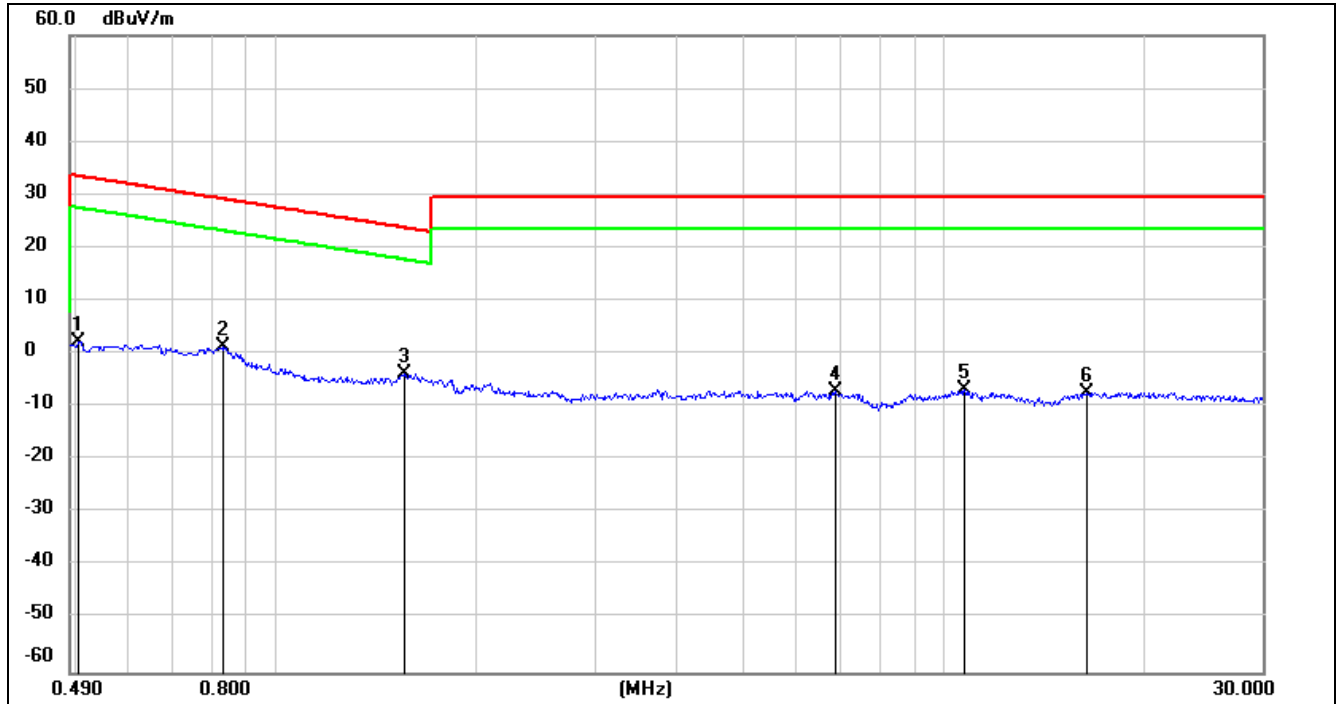

No.	Frequency (MHz)	Reading (dBuV)	Correct (dB/m)	FCC Result (dBuV/m)	FCC Limit (dBuV/m)	ISED Result (dBuA/m)	ISED Limit (dBuA/m)	Margin (dB)	Remark
1	0.5039	64.44	-62.07	2.37	33.56	-49.13	-17.94	-31.19	peak
2	0.8296	63.44	-62.17	1.27	29.23	-50.23	-22.27	-27.96	peak
3	1.5564	58.18	-62.02	-3.84	23.76	-55.34	-27.74	-27.60	peak
4	6.8936	54.09	-61.22	-7.13	29.54	-58.63	-21.96	-36.67	peak
5	10.7299	53.98	-60.83	-6.85	29.54	-58.35	-21.96	-36.39	peak
6	16.3959	53.67	-60.96	-7.29	29.54	-58.79	-21.96	-36.83	peak

Note: 1. Measurement = Reading Level + Correct Factor (dBuA/m= dBuV/m- 20Log10[120π] = dBuV/m- 51.5).

2. If Peak Result complies with AV and QP limit, AV and QP Result are deemed to comply with AV limit.

3. All 3 polarizations (Horizontal, Face-on and Face-off) of the loop antenna had been tested, but only the worst data recorded in the report.

Note: All the channels have been tested, only the worst data was recorded in the report.



## 9. ANTENNA REQUIREMENTS

### APPLICABLE REQUIREMENTS

Please refer to FCC §15.203

An intentional radiator shall be designed to ensure that no antenna other than that furnished by the responsible party shall be used with the device. The use of a permanently attached antenna or of an antenna that uses a unique coupling to the intentional radiator shall be considered sufficient to comply with the provisions of this section. The manufacturer may design the unit so that a broken antenna can be replaced by the user, but the use of a standard antenna jack or electrical connector is prohibited.

Please refer to FCC §15.247(b)(4)

The conducted output power limit specified in paragraph (b) of this section is based on the use of antennas with directional gains that do not exceed 6 dBi. Except as shown in paragraph (c) of this section, if transmitting antennas of directional gain greater than 6 dBi are used, the conducted output power from the intentional radiator shall be reduced below the stated values in paragraphs (b)(1), (b)(2), and (b)(3) of this section, as appropriate, by the amount in dB that the directional gain of the antenna exceeds 6 dBi.

### RESULTS

Complies



## 10. APPENDIX

### 10.1. Appendix A: DTS Bandwidth

#### 10.1.1. Test Result

Test Mode	Antenna	Channel	DTS BW [MHz]	FL[MHz]	FH[MHz]	Limit[MHz]	Verdict
ZIGBEE	Ant1	2405	0.970	2404.470	2405.440	0.5	PASS
		2445	0.975	2444.465	2445.440	0.5	PASS
		2480	0.975	2479.465	2480.440	0.5	PASS

### 10.1.2. Test Graphs

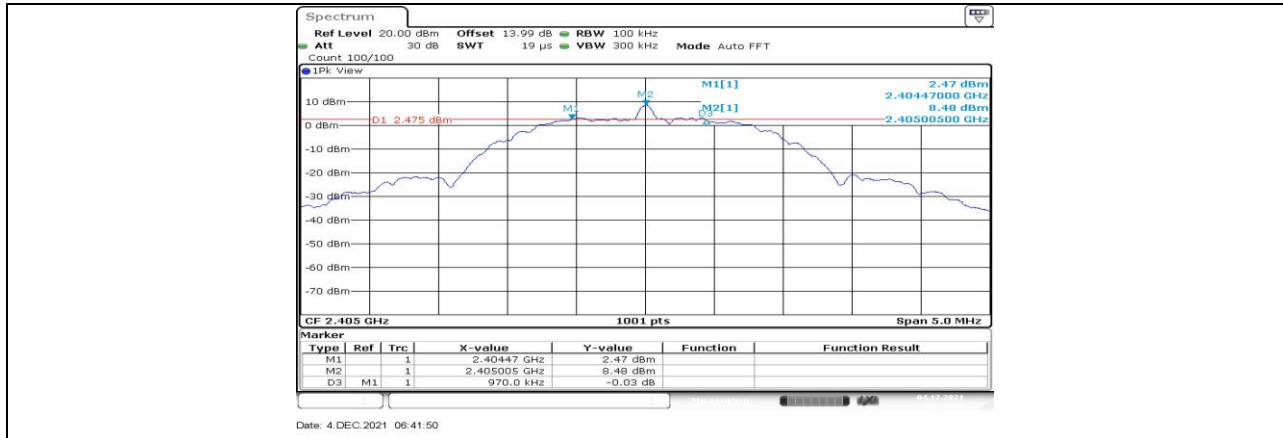

ZIGB\_Ant1\_2405

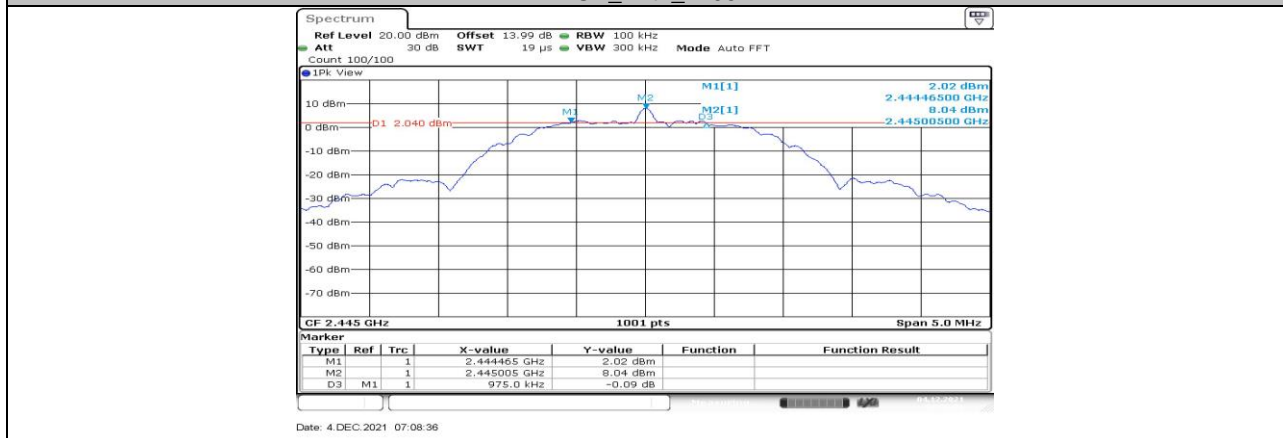

ZIGB\_Ant1\_2445

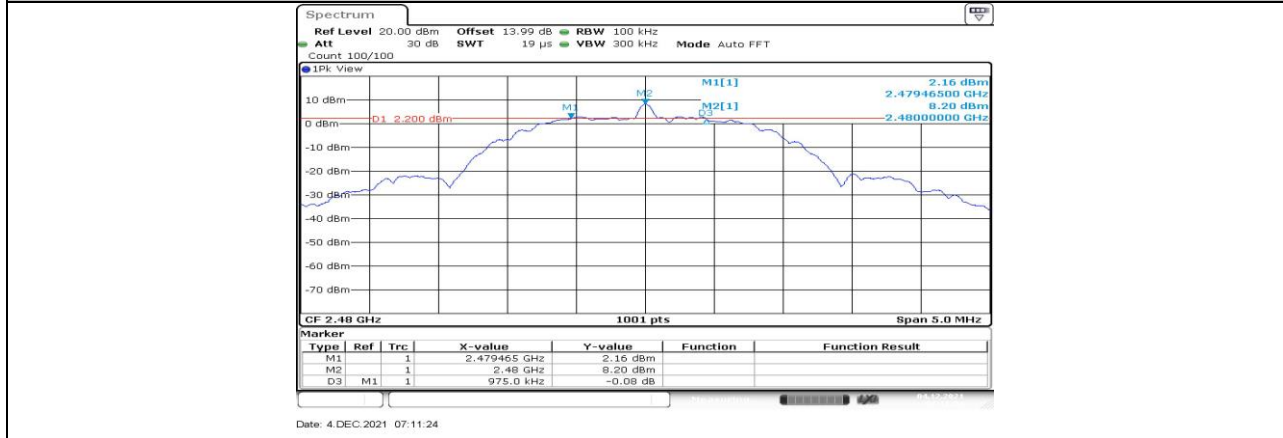

ZIGB\_Ant1\_2480



## 10.2. Appendix B: Occupied Channel Bandwidth

### 10.2.1. Test Result

Test Mode	Antenna	Channel	OCB [MHz]	FL[MHz]	FH[MHz]	Verdict
ZIGBEE	Ant1	2405	2.243	2403.881	2406.124	PASS
		2445	2.233	2443.886	2446.119	PASS
		2480	2.228	2478.891	2481.119	PASS

### 10.2.2. Test Graphs

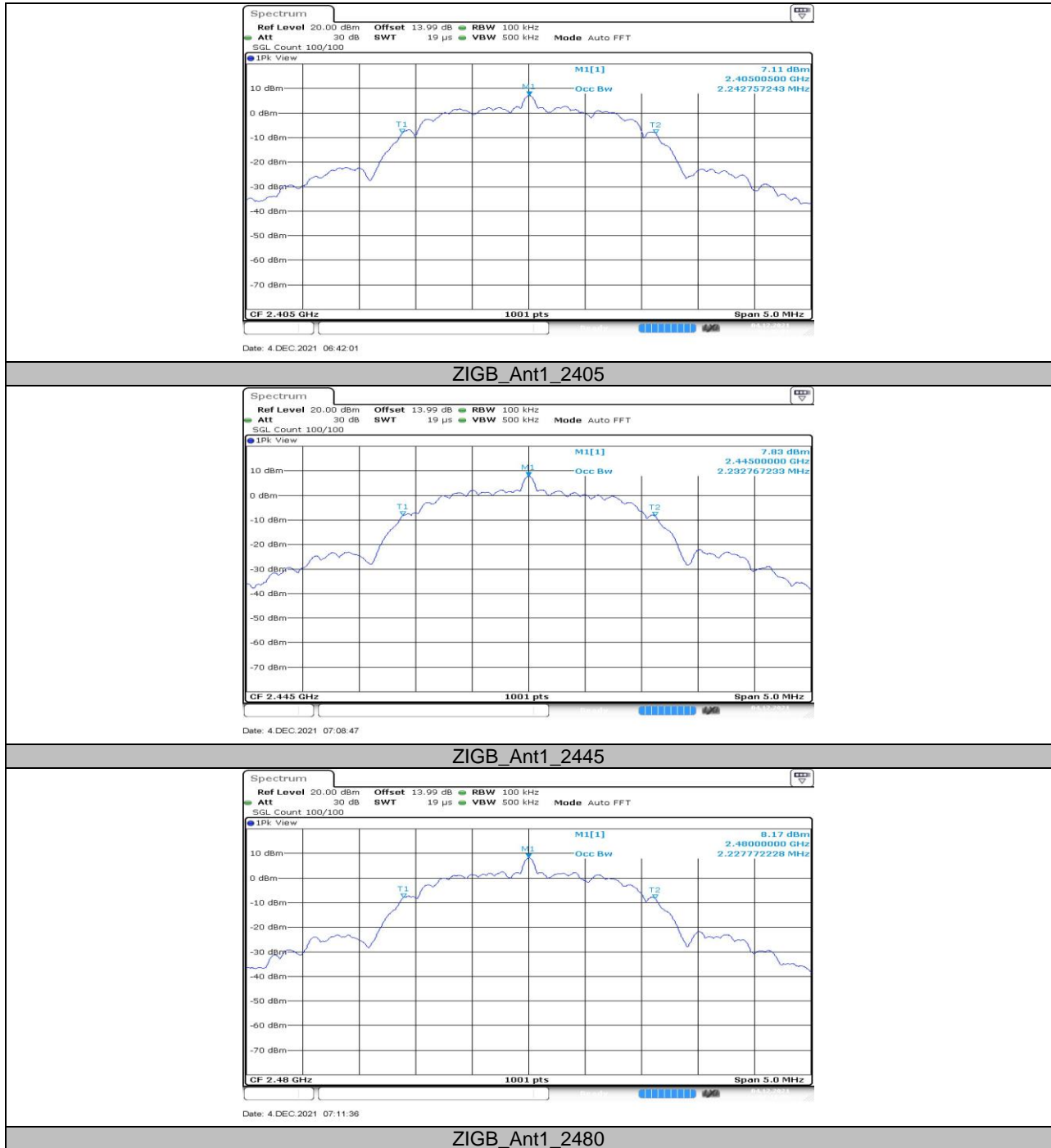



### 10.3. Appendix C: Maximum conducted output power

#### 10.3.1. Test Result

Test Mode	Antenna	Channel	Result[dBm]	Limit[dBm]	Verdict
ZIGBEE	Ant1	2405	6.31	≤30	PASS
		2445	5.79	≤30	PASS
		2480	5.99	≤30	PASS



## 10.4. Appendix D: Maximum power spectral density

### 10.4.1. Test Result

Test Mode	Antenna	Channel	Result[dBm/3kHz]	Limit[dBm/3kHz]	Verdict
ZIGBEE	Ant1	2405	-8.83	≤8.00	PASS
		2445	-9.18	≤8.00	PASS
		2480	-9.05	≤8.00	PASS



### 10.4.1. Test Graphs

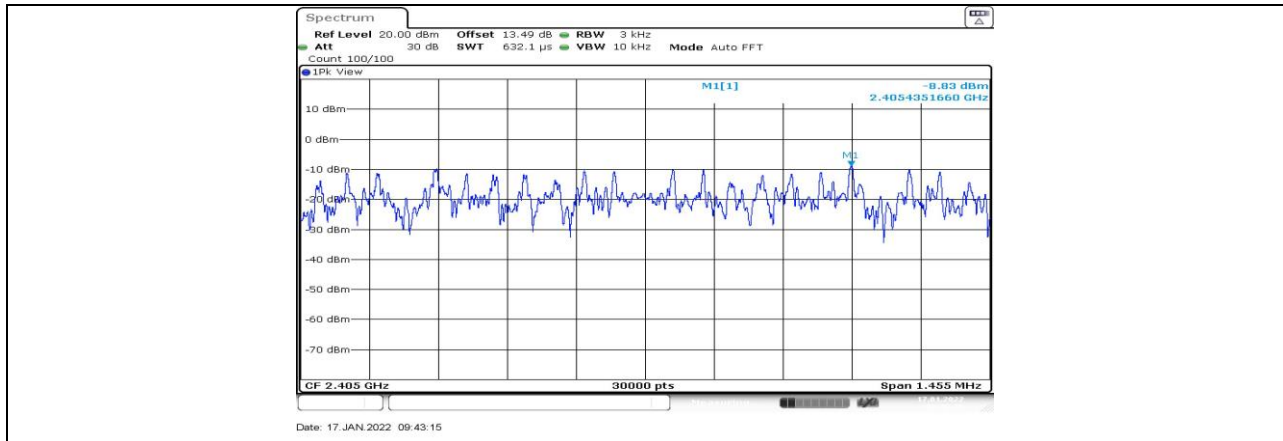

ZIGB\_Ant1\_2405

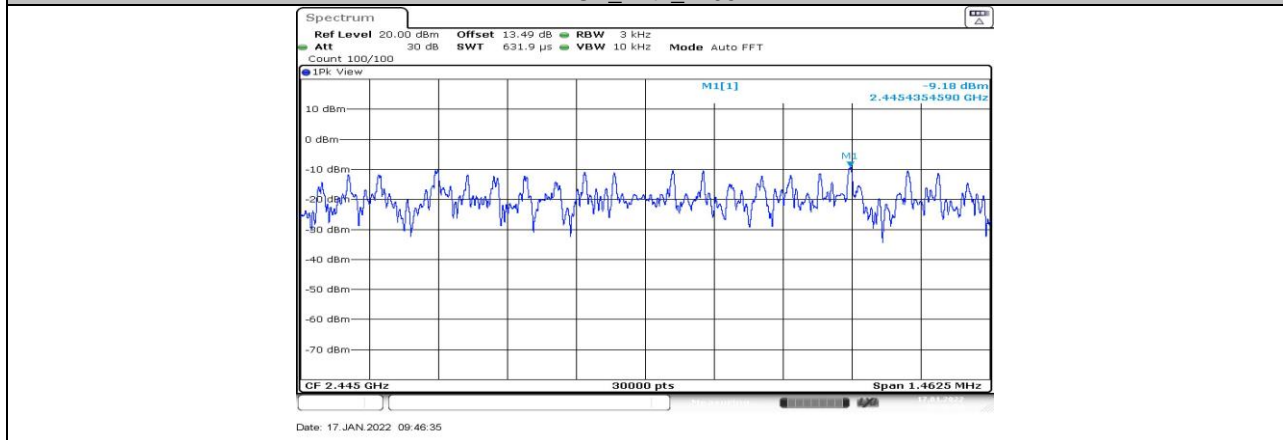

ZIGB\_Ant1\_2445

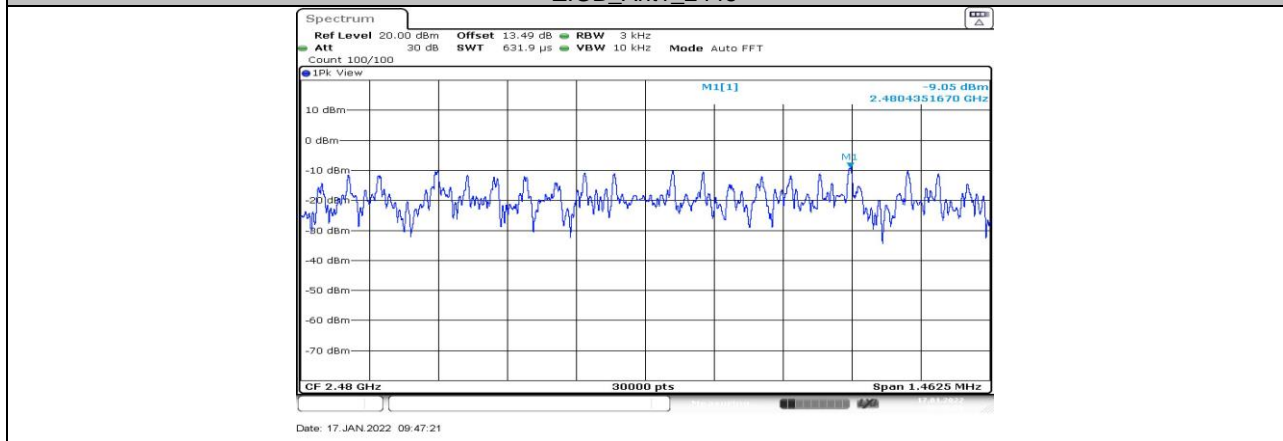

ZIGB\_Ant1\_2480



## 10.5. Appendix E: Band edge measurements

### 10.5.1. Test Result

Test Mode	Antenna	ChName	Channel	RefLevel[dBm]	Result[dBm]	Limit[dBm]	Verdict
ZIGBEE	Ant1	Low	2405	7.49	-45.41	$\leq -12.51$	PASS
		High	2480	8.20	-40.51	$\leq -11.8$	PASS

### 10.5.2. Test Graphs

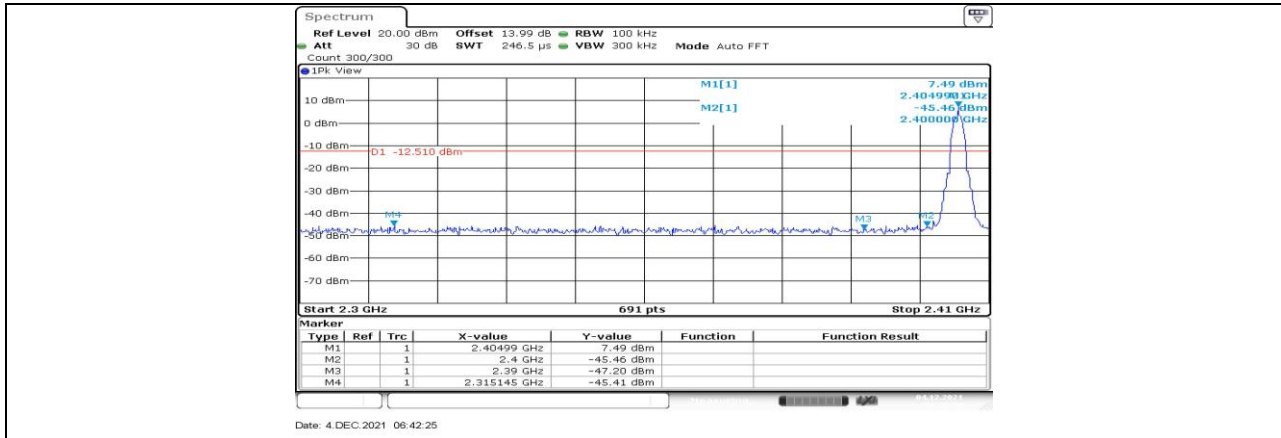

ZIGB\_Ant1\_Low\_2405

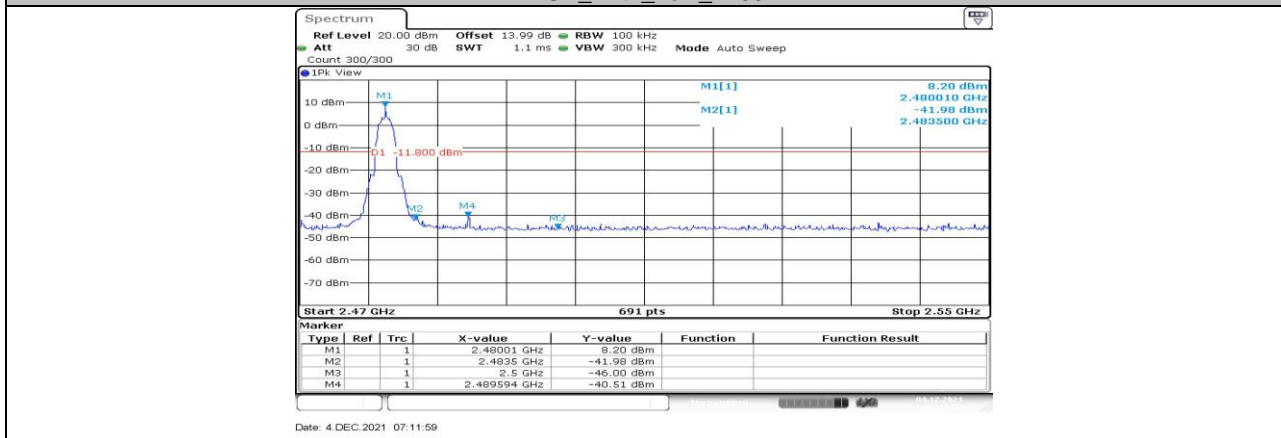

ZIGB\_Ant1\_High\_2480



## 10.6. Appendix F: Conducted Spurious Emission

### 10.6.1. Test Result

Test Mode	Antenna	Channel	FreqRange [MHz]	Result[dBm]	Limit[dBm]	Verdict
ZIGBEE	Ant1	2405	Reference	8.47	---	PASS
			30~1000	-53.81	$\leq -21.53$	PASS
			1000~26500	-47.35	$\leq -21.53$	PASS
		2480	Reference	8.19	---	PASS
			30~1000	-53.87	$\leq -21.81$	PASS
			1000~26500	-48.62	$\leq -21.81$	PASS

### 10.6.2. Test Graphs

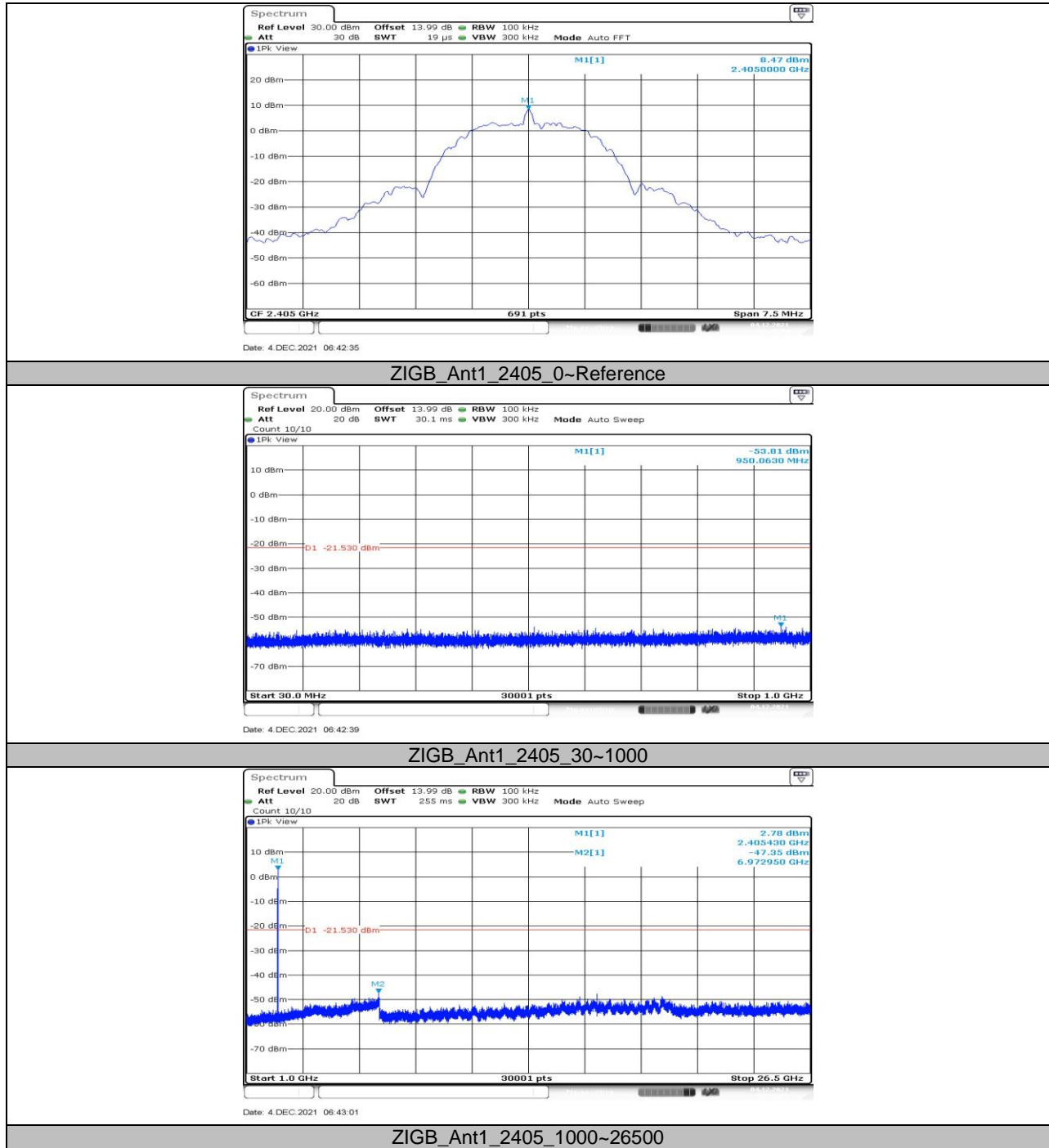



Date: 4 DEC 2021 07:12:05

### ZIGB\_Ant1\_2480\_0~Reference

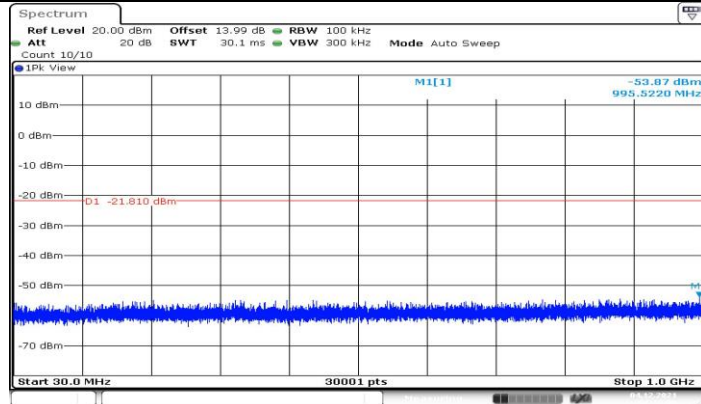

Date: 4 DEC 2021 07:12:09

### ZIGB\_Ant1\_2480\_30~1000

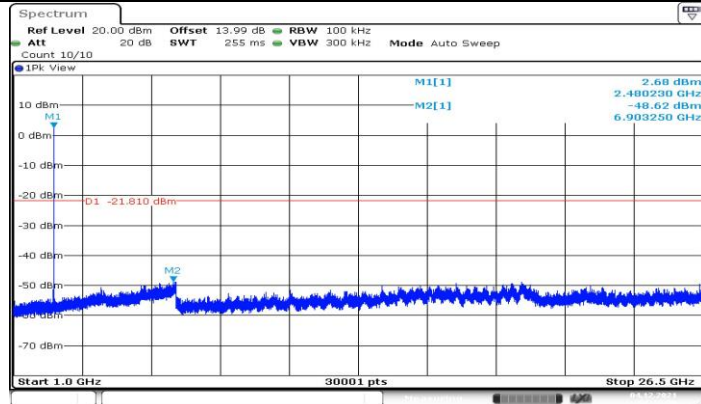

Date: 4 DEC 2021 07:12:31

### ZIGB\_Ant1\_2480\_1000~26500



**10.7. Appendix G: Duty Cycle**  
**10.7.1. Test Result**

Test Mode	On Time (msec)	Period (msec)	Duty Cycle x (Linear)	Duty Cycle (%)	Duty Cycle Correction Factor (dB)	1/T Minimum VBW (kHz)	Final setting For VBW (kHz)
ZIGBEE	0.60	0.93	0.6452	64.52	1.90	1.67	2

Note:

Duty Cycle Correction Factor=10log (1/x).

Where: x is Duty Cycle (Linear)

Where: T is On Time

If that calculated VBW is not available on the analyzer then the next higher value should be used.

### 10.7.2. Test Graphs

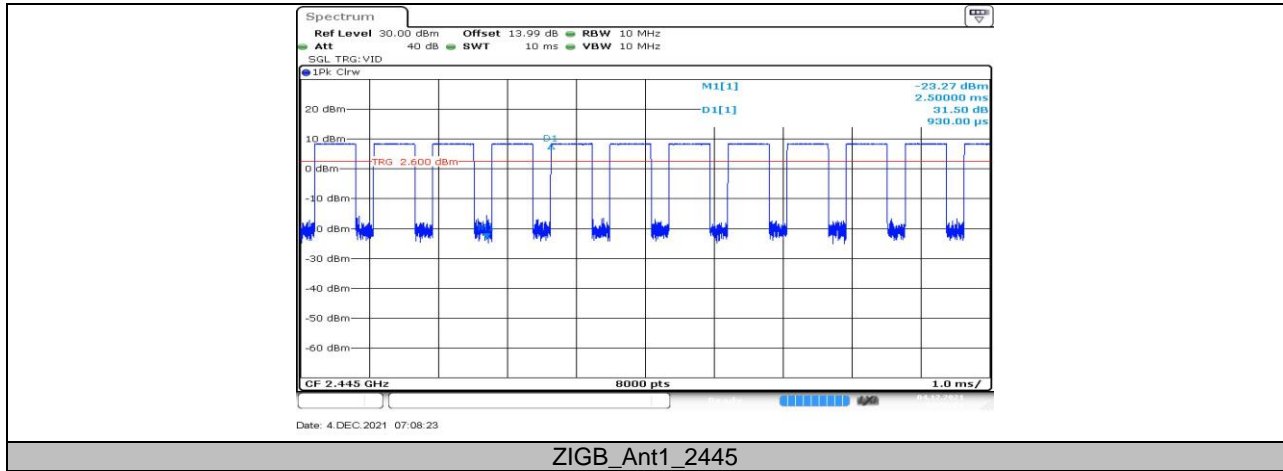

**END OF REPORT**