

SYCLOPE ODITouch® Controller for public swimming pool (Part 2)



General programming instructions



Reference: DOC0460

Rev: 1.1

Part of the general documentation

- Part 1: Installation and starting instructions
- ▶ Part 2: General programming instructions
- Part 3: Communication programming instructions

General information:

SYCLOPE Electronique 2017 -2019[®] Manual of 04/02/2020 Rev 1.1

Analysers/Controllers for swimming pools.

Product line ODITouch[®]

Part 2: General programming instructions (Ref: DOC0460)

Editor :



SYCLOPE Electronique S.A.S.

Z.I. Aéropole pyrénées

Rue du Bruscos

64 230 SAUVAGNON - France –

Tel: (33) 05 59 33 70 36

Fax: (33) 05 59 33 70 37

Email: syclope@syclope.fr

Internet: <http://www.syclope.fr>

© 2017 by SYCLOPE Electronique S.A.S.

Subject to modification

Contents

I. Generality.....	5
1) Scope	5
2) FCC conformity	5
3) Use of the document	6
4) Symbols and signs	6
5) Storage and transport	7
6) Packaging	7
7) Warranty.....	7
II. Safety and environmental instructions.....	8
1) Use of the equipment.....	8
2) User obligations	8
3) Risk prevention.....	8
4) Identification and localization of the nameplate	9
5) Disposal and conformity	9
6) Radio technologies in equipment.....	10
III. Display mode and type	11
IV. Programming home screen [0001]	11
V. Programming screen « INSTALLATION » [0031].....	12
1) Menu « Configuration & Installation » - « OPTIONS » [0131] & [1131].....	12
2) Menu « Configuration & Installation » - « INPUTS » [0231]	14
a) 4...20mA analog or potentiometric input configuration [1231]	15
b) Digital input configuration [2231]	17
3) Menu « Configuration & Installation » - « TIMERS » [0331].....	19
4) Menu « Configuration & Installation » - « MEASURES & CALCULATIONS » [0431]	20
a) Parameter configuration [1431].....	21
b) Parameter configuration - « simple »	21
c) pH parameter options.....	22
d) Conductivity parameter options	22
e) Salinity calculation options	23
f) TDS calculation options	23
g) Free chlorine, Active chlorine, and Active bromine calculation options.....	24
h) Chloramine calculation options	24
5) Menu « Configuration & Installation » - « OUTPUTS » [0531]	25
a) Relay outputs in dose (On / Off) control mode [1531].....	26
b) Relay outputs in PWM (Pulse Width Modulation) dosing mode [1531].....	27
c) Relay outputs in PFM (Pulse Frequency Modulation) dosing mode [1531].....	28
d) Relay outputs in Alarm mode [1531].....	29
e) Relay outputs in State mode [1531].....	30
g) Outputs 4...20mA in dosage mode [2531]	32
h) Output 4...20mA in Transfer mode [2531].....	33
6) Menu « Configuration & Installation » - « CONDITIONS » [0631].....	34
a) Setting the conditions of a parameter [2531].....	35
7) Menu « Configuration des communications » - « COMMUNICATION » [0731].....	36
8) Menu « Configuration & Installation » - « RESET FACTORY » [0831].....	36
VI. Programming screen « SETTINGS » [0021]	38
1) Menu « Settings » - « OPTIONS » [0121].....	38
2) Menu « Settings » - « Setpoint & dosage » [0221].....	39

a)	Dosage mode – Hysteresis [1221]	40
b)	Dosage mode – Threshold [1221].....	41
c)	Dosage mode – P.I.D [1221].....	43
3)	<u>Menu « Settings » - « ALARMS » [0321]</u>	<u>44</u>
4)	<u>Menu « Settings » - « CALIBRATION » [0421].....</u>	<u>47</u>
a)	Calibration screen presentation [1421].....	47
b)	Calibration menu.....	48
c)	Calibration status	48
d)	Calibration input	49
e)	Calibration validation messages.....	49
f)	Offset calibration	50
g)	Slope calibration	50
h)	Erasing the calibration	50
i)	2 points calibration (pH).....	50
j)	Temperature compensation (pH).....	50
5)	<u>Menu « Settings » - « FLOWRATE » [0521].....</u>	<u>52</u>
a)	« Standard » version	52
b)	« Sensors & parameters » version	53
6)	<u>Menu « Settings » - « TANK LEVEL 4...20mA » [0621].....</u>	<u>54</u>
a)	« Standard » version	54
b)	« Sensors & parameters » version	55
7)	<u>Menu « Settings » - « TRANSFERs 4...20mA » [0721]</u>	<u>56</u>
8)	<u>Menu « Settings » - « SCHEDULES »</u>	<u>57</u>
VII.	Programming screen « USER » [0011]	58
1)	<u>Menu « User » - « GENERAL CONFIGURATION » [0111]</u>	<u>58</u>
a)	Menu « General configuration » - « SCREEN » [0111]	58
b)	Menu « General configuration » - « SOUNDS » [0111]	59
c)	Menu « General configuration » - « COLORS » [0111].....	60
d)	Menu « General configuration » - « INDICATORS » [0111].....	61
e)	Menu « General configuration » - « BUTTON » [0111]	62
f)	Menu « General configuration » - « ALARMS » [0111].....	63
g)	Menu « General configuration » - « RESTORE » [0111].....	64
2)	<u>Menu « User » - « DISPLAY » [0211].....</u>	<u>65</u>
a)	Automatic display.....	65
b)	Manual display.....	65
3)	<u>Menu « User » - « DATE & TIME » [0311].....</u>	<u>67</u>
4)	<u>Menu « User » - « LANGUAGE » [0411]</u>	<u>68</u>
5)	<u>Menu « User » - « USB » [0511]</u>	<u>68</u>
6)	<u>Menu « User » - « INPUTS TEST » [0611].....</u>	<u>70</u>
7)	<u>Menu « User » - « OUTPUTS TEST » [0711].....</u>	<u>71</u>
8)	<u>Menu « User » - « INFO » [0811].....</u>	<u>72</u>
VIII.	Service / Maintenance	73

I. Generality

1) Scope

SYCLOPE ODITouch® analyser/controller you have purchased is a high-tech electronic device. It was designed and created carefully for your enjoyment and your peace of action.

Its remarkable faculty to adapt to different swimming pool structures allows it to settle in all difficult environments where mastery of water treatment is most decisive.

Thanks to ODITOUCH ease of use, their user-friendliness and their remarkable technicality, you will fully enjoy its many possibilities and will be assured of a perfect control and perfect monitoring of your pool water quality.

You will find in the instructions that follow, all the information needed for the installation, use and maintenance of your new equipment.

- Packaging
- Installation
- Basic equipments
- Specifications
- Commissioning instructions
- Safety instructions

If you need more information or if you encounter problems that not have been specified in this guide, please quickly contact your retailer or SYCLOPE Electronique S.A. sales department, either at the agency or office in your area, or at technical/quality service at our head office. We will do our best to help you and make you enjoy our advice and our knowledge in the field of measurement and treatment of pools water.

Contact : Service-technique@syclope.fr

2) FCC conformity

The **SYCLOPE ODITouch®** controller complies with Part 15 of the FCC Rules.

Operation is subject to the following two conditions:

(1) this device may not cause harmful interference (2) this device must accept any interference received, including interference that may cause undesired operation FCC Regulations state that unauthorized changes or modifications to this equipment may void the user's authority to operate it.



This equipment has been tested and found to comply with the limits for a Class B digital device, pursuant to Part 15 of the FCC Rules. These limits are designed to provide reasonable protection against harmful interference in a residential installation. This equipment generates, uses, and can radiate radio frequency energy and, if not installed and used in accordance with the instructions, may cause harmful interference to radio communications. However, there is no guarantee that interference will not occur in a particular installation.

If this equipment does cause harmful interference to radio or television reception, which can be determined by turning the equipment off and on, the user is encouraged to try and correct the interference by one or more of the following measures:

- Reorient or relocate the receiving antenna.
- Increase the separation between the equipment and receiver.
- Connect this equipment into an outlet on a circuit different from that to which the receiver is connected.
- Consult the dealer or an experienced radio/TV technician for help.

Changes and modifications not expressly approved by the manufacturer could void the user's authority to operate this equipment.

Remark: To ensure compliance with the FCC regulations on electromagnetic interference for a class B device, use cables properly shielded and connected to the ground as recommended in this manual. The use of a cable that is not properly shielded or earthed for risk of violating the FCC rules.

Radio Frequency (RF) Exposure Compliance of Radiocommunication for mobile Apparatus To satisfy FCC RF Exposure requirements for mobile devices, a separation distance of 20 cm or more should be maintained between the antenna

of this device and persons during operation. To ensure compliance, operation at closer than this distance is not recommended. This transmitter must not be co-located or operating in conjunction with any other antenna or transmitter.

Contains:

- WiFi module: FCC ID : 2AC7Z-ESPWROOM02

This device complies with part 15 of the FCC Rules. Operation is subject to the following two conditions: (1) This device may not cause harmful interference, and (2) this device must accept any interference received, including interference that may cause undesired operation.

- GSM module: FCC ID: UDV-0912142009007

This device complies with part 15 of the FCC Rules. Operation is subject to the following two conditions: (1) This device may not cause harmful interference, and (2) this device must accept any interference received, including interference that may cause undesired operation. (for FCC)

3) Use of the document

Please read carefully the entire document before starting the installation and the commissioning of the controller device, in order to ensure the safety of swimmers, users and equipment's.

The information provided in this document must be strictly observed. **SYCLOPE Electronique S.A.S.** declines all responsibility in cases where failure to comply with the instructions of this documents.

The following symbols and pictograms will be used to facilitate reading and understanding of these instructions.

- Information
- ▶ Action to do
- Element of a list or enumeration

4) Symbols and signs



Identification of a continuous voltage or current



Identification of an alternative voltage or current



Protective ground



Functionnal ground



Risk of injury or accident. Identifies a warning concerning a potentially dangerous risk. The documentation must be consulted by the user with each time the symbol is notified. If the instructions are not respected, this presents risks of death, physical injuries or property damages.



Electric hazard. Identifies a warning statement relative to a mortal electric danger. If the instructions are not strictly respected, this implies an inevitable risk of physical injuries or death.



Risk of incorrect operation or damage for the device



Comment or particular information.



Recyclable element

5) Storage and transport



It is important to store and to transport the **SYCLOPE ODITOUCH** controller in its original packaging in order to minimize risk of damage.

Furthermore, the package must be stored in an environment that is protected against humidity and exposure to chemical products.

Environmental conditions for transport and storage:

Temperature: -10 °C à 70 °C

Air humidity: Maximum of 90% with no condensation

6) Packaging



The device is delivered without power cable.

Caps of the box are pre-drilled and fitted with corresponding cable glands conform to the maintenance of IP65 protection. Cables used must be adapted to them in order to respect the protection index.

Shielded cables for connecting pH and ORP electrodes are not supplied.

The controller is delivered with:

- ✓ **SYCLOPE ODITouch**® central analyser/controller
- ✓ Installation and starting instructions
- ✓ General programming instructions
- ✓ Communication programming instructions (Option)

7) Warranty

The warranty is provided according to the terms of our general conditions of sale and delivery as long as the following conditions are met:

- Use of the equipment according to the instructions of this notice
- No modifications of the equipment which may modify its behaviour and no incorrect manipulation
- Respect for the electrical safety conditions



Consumable material is no longer covered by warranty as soon as it's put into service.

II. Safety and environmental instructions

Please:

- Read this manual carefully before the unpacking, the installing or the commissioning of this equipment
- Take into account all the hazards and of recommended precautionary measures

The failure to respect these procedures can result in serious injury to users or damaging the device.

1) Use of the equipment

SYCLOPE ODITouch® controllers has been designed to measure and control pH, Chlorine, Bromine (BCDMH) using appropriate sensors and actuator controls within the scope of use described in this manual.



All other uses are considered to be non-conforming and must therefore be forbidden. SYCLOPE Electronique S.A.S. will not be responsible in any case for any damage that result from such uses.

2) User obligations

The user undertakes not to allow its employees to work with the **SYCLOPE ODITouch®** controller described in this manual unless they:

- Are aware of the fundamental instructions relating to work safety and prevention of accidents
- Are trained in the use of the device and its environment
- Have read and understood these instructions, warnings and manipulation rules

3) Risk prevention



The installation and connection of the **SYCLOPE ODITouch®** controller should be only performed by specialized personnel and qualified for this task.
The installation must comply with the current safety standards and instructions!



Before opening the controller or manipulate the relay outputs, always remember to switch-off the primary power supply!
Never open the controller when it is powered on!
Maintenance operations and repairs should be only performed by trained and specialized personnel!



Take care when choosing the location for installing the controller!
SYCLOPE ODITouch® controller should not be installed in a hazardous environment and should be protected against splashing with water or chemical products. It should be installed in a dry, well-ventilated and isolated location.



Make sure that the chemical sensors used with this controller correspond well to the chemicals used. Refer to the individual technical note of each sensor. Chemistry of water is very complex, in case of doubt, contact immediately our engineering service or your approved installer/reseller.



Chemical sensors are sensitive elements using consumable parts. They must be supervised, maintained and calibrated regularly using specific calibrator systems not-provided with this equipment. In the event of defect, a surplus possible hazard of chemical injections can be noted. In the doubt, a service contract must be taken near your reseller/installer or failing this near our engineering services. Contact your approved installer/reseller or our business service for more information.

4) Identification and localization of the nameplate

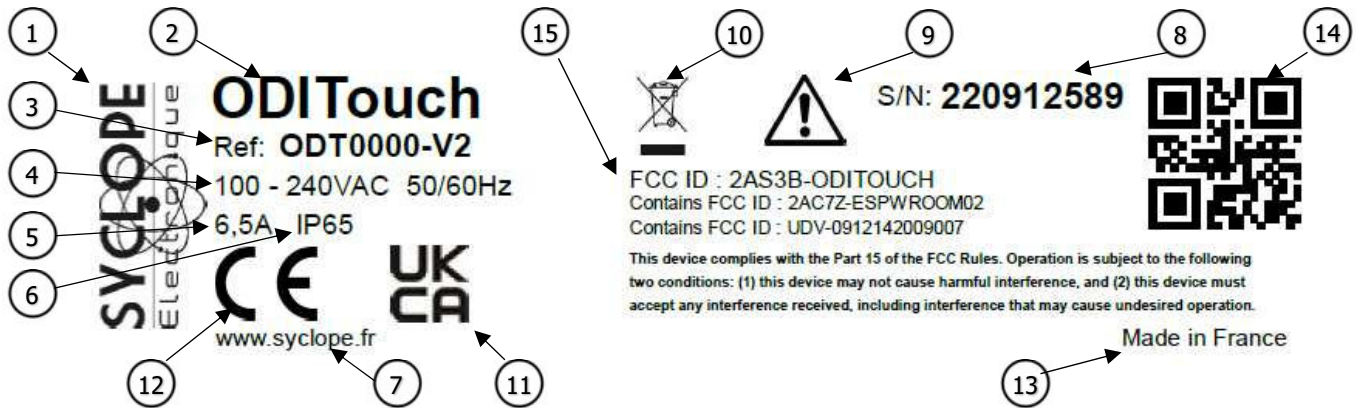

①	Manufacturer's label	⑨	Particular risk. Read the manual
②	Model of the product	⑩	Product which can be recycled
③	Reference of the product	⑪	Limitation of dangerous substance
④	Range of power supply	⑫	CE approved
⑤	Values of maximum current	⑬	Country of manufacture
⑥	Class of protection	⑭	Manufacturer square code
⑦	Identification of the manufacturer	⑮	FCC ID
⑧	Serial number		

Nameplate



5) Disposal and conformity

The recyclable packaging of the **SYCLOPE ODI Touch**[®] equipment must be disposed of according to current regulations.



Elements such as paper, cardboard, plastic or any other recyclable elements must be taken to a suitable sorting center.



According to European directive 2012/19/EC, this symbol means that as of 4 July 2012 electrical appliances cannot be thrown out together with household or industrial waste. According to current regulations, consumers within the European Union are required, as of this date, to return their used devices to the manufacturer, who will take care of disposing them at no extra expense.



According to European directive 2011/65/EC, this symbol means that the **SYCLOPE ODI Touch**[®] controller is designed in compliance with the restrictions on hazardous substances.



According to low-voltage directive (2014/35/UE) and the electromagnetic compatibility directive (2014/30/UE), this symbol means that the device has been designed in compliance with the previously cited directives.



In accordance with part 15 of the FCC regulation (Federal communications commission), this symbol indicates that the device was tested and approved under the respect and the conditions of the limits for a Class B digital device.



The product complies with the requirements of IEC 61326-1 relating to immunity and emissions concerning electromagnetic compatibility in a basic environment.

6) Radio technologies in equipment

Radio technologies			
Technologies	Number of antenna	Radiated powers	Frequency bands of use
WIFI	1	< 20dBm	2400 MHz to 2483.5 MHz 2.4 GHz Band Exclusion Band : [2280 MHz – 2603.5 MHz]

III. Display mode and type

SYCLOPE ODITouch® regulator are fitted with a color touch screen graphic, all programming actions are realized with by pressing the screen. The touch screen is a resistive technology, you must press firmly on the screen to validate the action.

See. DOC0450 – Installation and instructions ODITOUCH ENG Rev1

IV. Programming home screen [0001]

To open the programming screen, press the key



on the main display screen.

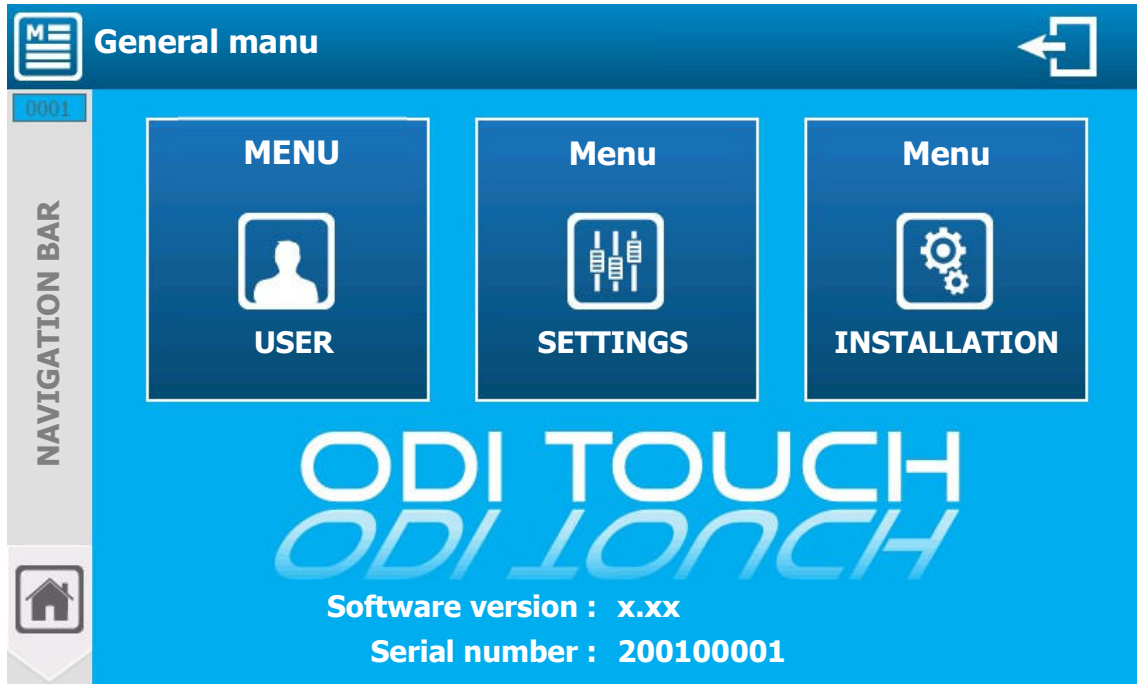

When an access code is entered to lock the "SETTINGS" or "INSTALLATION" menu the two buttons have the appearance below:

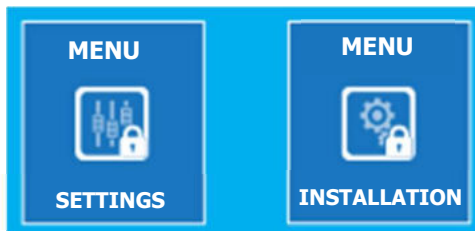

Menus with a padlock icon are password protected.



Press the menu you want to access to open the password entry window.

You must type the 4-digit user code then validate to access to the "SETTINGS" or "INSTALLATION" menu

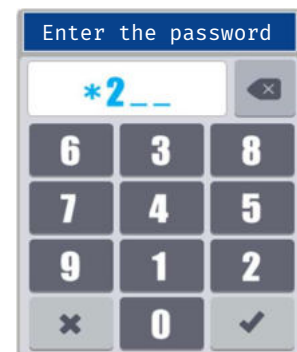

V. Programming screen « INSTALLATION » [0031]



« INSTALLATION » menu will allow you to access all the configuration for the first use of your controller.

Press to open following screen.

« Configuration & Installation » menu

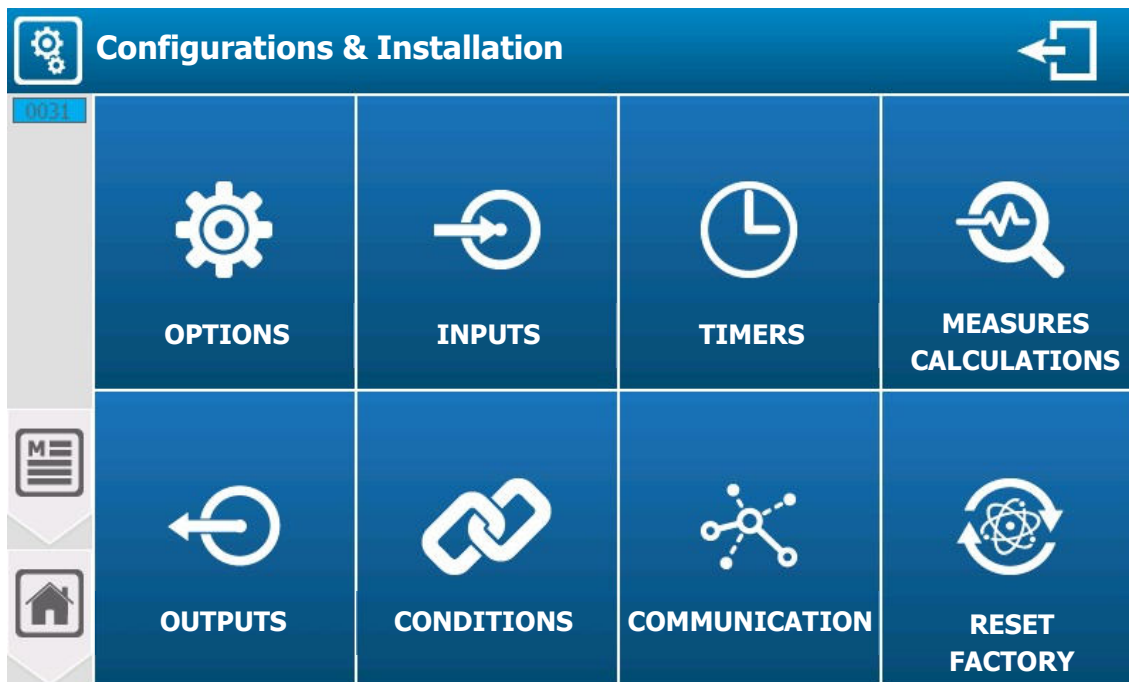

1) Menu « Configuration & Installation » - « OPTIONS » [0131] & [1131]

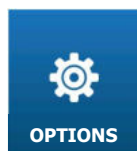

« OPTIONS » menu will allow you to access the options available in the installation part.

Press to open following screen.

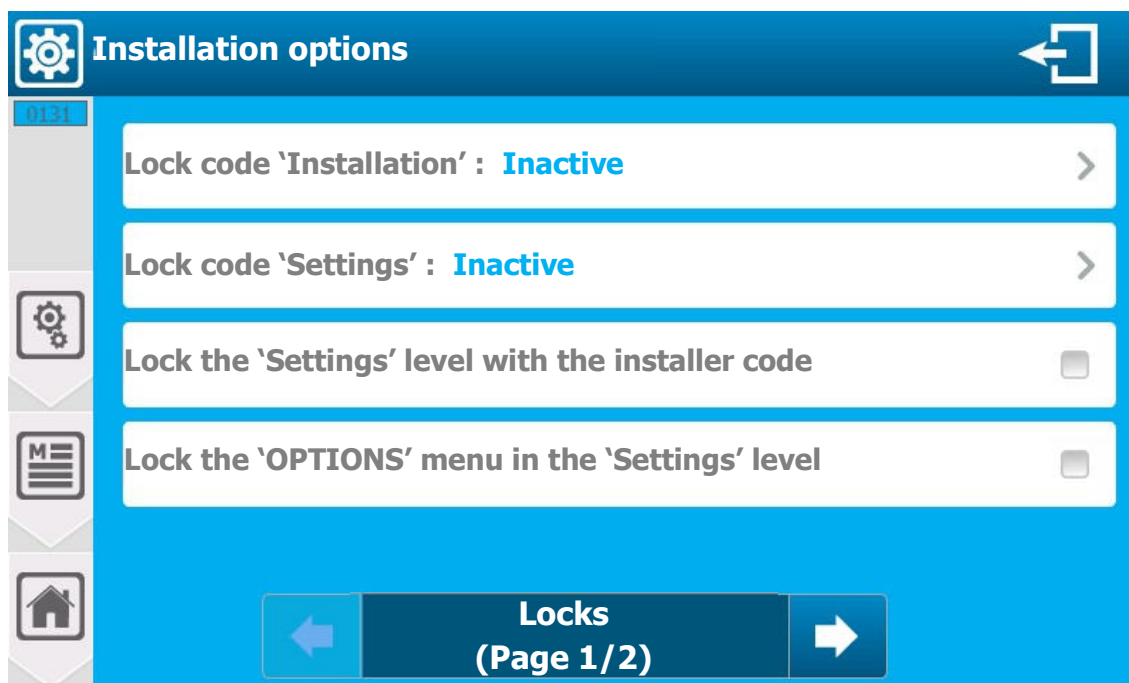

- **Lock code « Installation »**
 - Activate or deactivate the security code to access the « Installation » menu
- **Lock code « Settings »**
 - Activate or deactivate the security code to access the « Settings » menu
- **Lock the « Settings » level with the installer code**
 - Use the « Installer » code to lock the « Settings » menu
- **Lock the « Options » menu in the « Settings » level**
 - Lock and don't give access to the options in the « Settings » menu

Press  to access to the following page of OPTIONS in the "INSTALLATION" menu

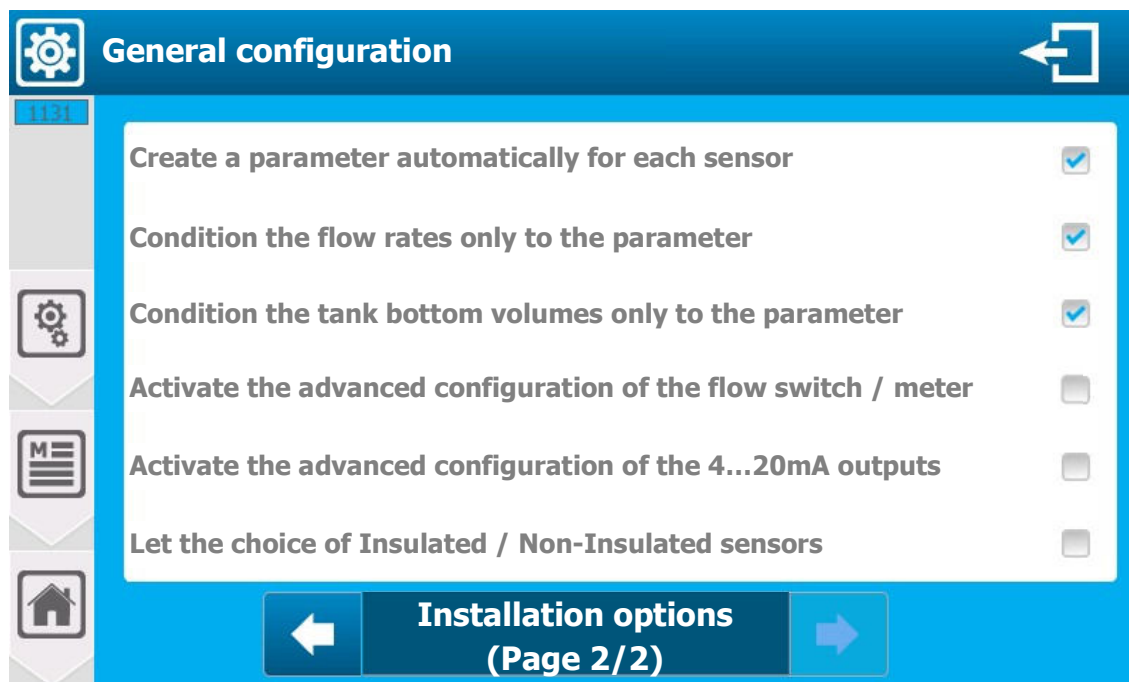

- **Create a parameter automatically for each sensor**
 - If this option is enabled, when adding a new sensor, a measurement parameter corresponding to the type of sensor is created automatically. It's still possible to modify and / or delete this parameter in a second step.



For a « simple » installation this option allows a faster configuration.

- **Condition the flow rates only to the parameter**
 - This option is used to separate the flow rate condition and parameter control.
If this box is unchecked, the control is performed at the sensor level and for each controlled parameter(s), it's necessary to set the control levels separately. This allows, for example, to control the dosing power differently from that of chlorine.
If this check box is checked, only one control level is set for all control parameters.
- **Condition the tank bottom volumes only to the parameter**
 - Same principle as the previous option but for the volume (level) sensors 4...20mA.
- **Activate the advanced configuration of the flow switch / meter**
 - If this box is checked, it's possible to manage the condition type between the water circulation detector and the flow meters to turn on or off the conditioning. The logical condition AND / OR is then configurable in the "Conditions" menu.
If this box is unchecked the **OR** condition is active by default.

- **Active the advanced configuration of the 4...20mA outputs**
 - This option, if checked, gives access to the « special » current settings. It's then possible to define the current generated in two special cases:
 - In dosage mode:
 - Fault current
 - Over range current
 - In transfer mode:
 - Inhibition current
 - Fault current
 - Over range current

- **Let the choice of Insulated / Non-insulated sensors**
 - This option, if checked, gives you the complete choice on the inputs sensors from AI1 to AI4.



AI3 & AI4 are inputs 4...20mA **NOT Isolated**, if the above option is checked, make sure that the sensor you select for these inputs is an isolated sensor.

2) Menu « Configuration & Installation » - « INPUTS » [0231]



« INPUTS » menu will allow you to access the configuration of the sensors that will be connected on the inputs (Potentiometric, Analog 4...20mA or Digital)

Press to open the following screen.

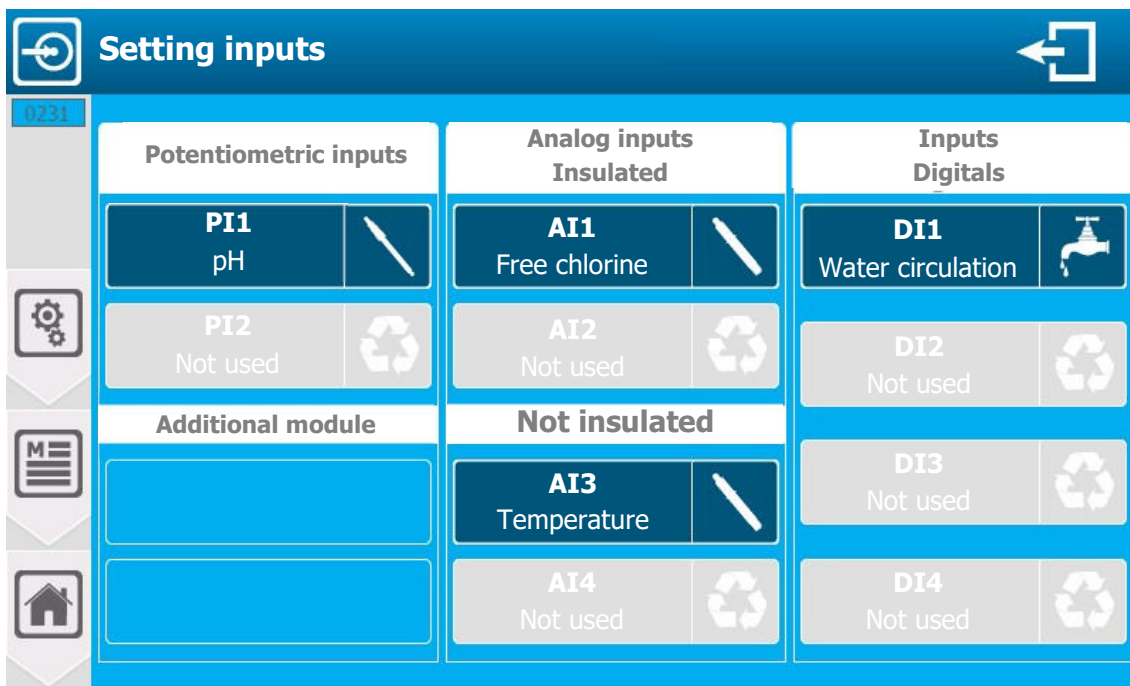

Screen presents inputs that are already configured and those that are not used. By pressing an already configured entry, you can change its configuration, or pressing an unused entry, configure its installation.



Entry already configured.
Press to edit its configuration.









Entry unused.
Press to configure its installation.

Option not accessible.

-  PI1 & PI2 Potentiometric inputs (pH, Rédox)
- AI1 & AI2 Isolated 4...20mA inputs
- AI3 & AI4 Not isolated 4...20mA inputs
- DI1 to DI4 Digital inputs (Contact)

 For your comfort, you will find the notation of the P_Ix, A_Ix and D_Ix inputs silkscreen in front of the corresponding connection terminal block of your device.

➤ **Common symbols**

	Unused entry		Input with flow sensor
	Input with potentiometric sensor		Input with water circulation sensor
	Input with 4...20mA sensor		Input R.I.C command & contact
	Input with volume sensor		Input Tank bottom

a) 4...20mA analog or potentiometric input configuration [1231]

PI1



Example with pH input edition
Press to open the following screen.

« Simple » view

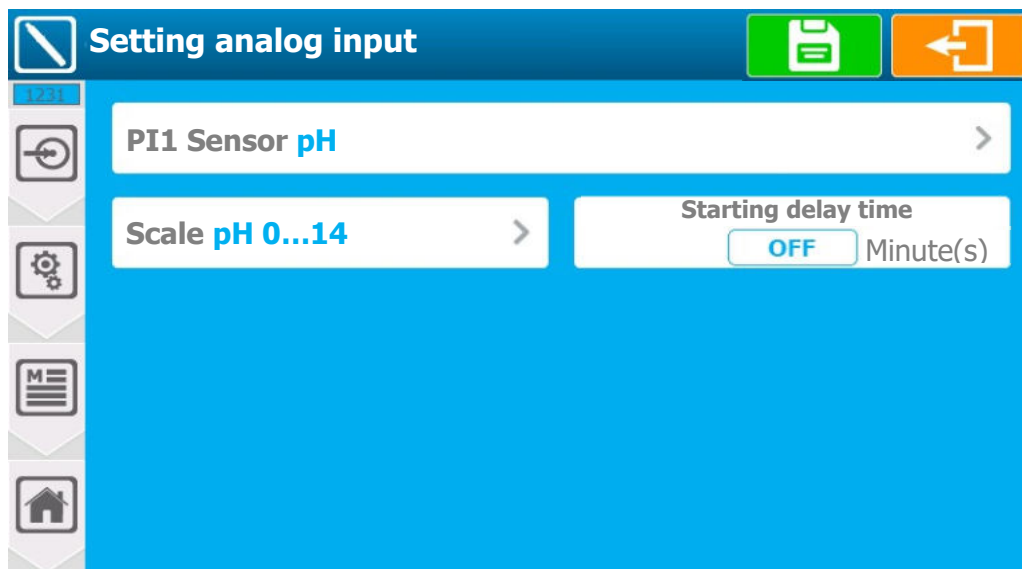

- **PI1 Sensor pH**
 - Select the sensor type, on this selection button you will find the information of the input being modified (**PI1**) and the currently selected sensor type (**pH**). Press to change it.

- **Scale pH 0...14**
 - Select the sensor measurement scale, on this selection button you will find the information of the currently selected scale (**pH 0...14**). Press to change it.



Each sensor has a « Customer » scale. By selecting this scale, it is then possible to select the low and high level of the scale and the unit of measurement. (See next screen)

- **Starting delay time OFF** Minute(s)
 - Enter boot delay (polarization). Here disabled for this type of sensor (**OFF**). Press to open the numeric keyboard and enter the desired value. Adjustment possible from **0 à 480** Minute(s).

To delete a sensor



- You must select « NO » from the sensor list and save your configuration by pressing the "SAVE" button.

« Customer » view

The screenshot shows the 'Setting analog input' screen for a 'PI1 Sensor pH'. The screen has a blue header with a pencil icon and the title 'Setting analog input'. On the right of the header are a green 'SAVE' button and an orange 'BACK' button. Below the header is a list of settings:

- PI1 Sensor pH** (with a right arrow)
- Scale Customer** (with a right arrow)
- Unit pH** (with a right arrow)
- Value min.** pH
- Value max.** pH
- Slope** mV/pH (this field is greyed out)
- Starting delay time** Minute(s)

- **Sensor – Scale – Temporization – Delete & Save**
 - See previous section.
- **Unit pH**
 - Select the unit of measurement of the sensor, on this selection button we find the information of the currently selected unit (**pH**). Press to change it.
- **Value min. 0** pH
 - Low sensor value input. Here the current value is (**0**). Press to open the numeric keyboard and enter the desired value.
- **Value max. 14** pH
 - High sensor value input. Here the current value is (**14**). Press to open the numeric keyboard and enter the desired value.
- **Slope 1,14** mV/pH
 - Sensor slope value information based on min & max values entered. This part is greyed out (not accessible), it is calculated automatically. In our case the calculated value is (**1,14**)



AI3 & AI4 are inputs 4...20mA **NOT Isolated**, if the above option is checked, make sure that the sensor you select for these inputs is an isolated sensor.

b) Digital input configuration [2231]

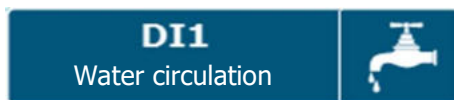

Example with the edition of a water circulation input.
Press to open the following screen.

« Standard » case

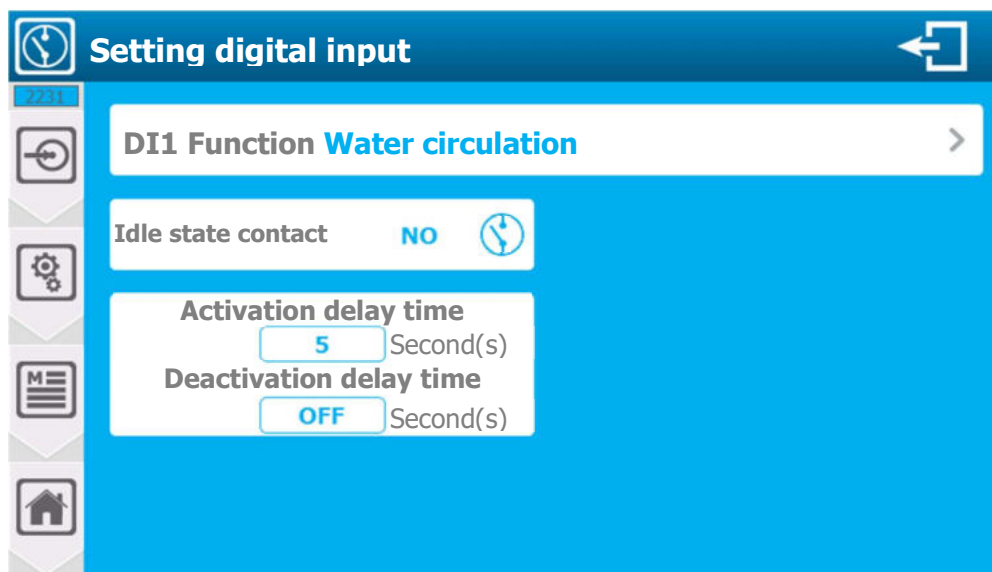

- **DI1 Function Water circulation**
 - Digital input operation mode selection, on this selection button we find the information of the input in the process of modification (**DI1**) and the currently selected function (**Water circulation**). Press to change it.
- **Idle state contact NO**
 - Choice of idle state to be taken into account, this check box contains the information currently selected (**NO**).
Press to toggle **NO** (normally open) mode to **NC** (normally closed) mode.
- **Activation delay time 5 Second(s)**
 - Enter the time that the input must remain during its activation before the information is taken into account. Here it is (**5**) seconds.
Press to open the numeric keyboard and enter the desired value.
Adjustment possible from **0 to 240** Second(s)
- **Deactivation delay time OFF Second(s)**
 - Same as before, but for reverse state.

**To delete an input contact:**

- You must select « NO » from the list of functions and save your configuration by pressing the "SAVE" button.

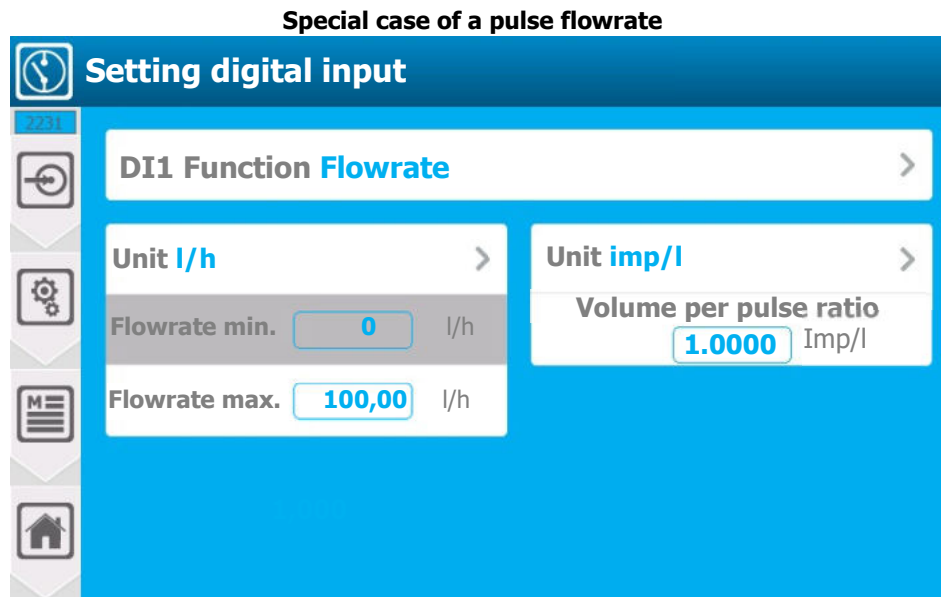

- **DI1 Function Flowrate**
 - Digital input operation mode selection, on this selection button we find the information of the input in the process of modification (**DI1**) and the currently selected function (**Flowrate**). Press to change it.
- **Unit l/h**
 - Select flowrate unit, selection button displays the information of the currently selected unit (**l/h**). Press to change it.
- **Flowrate min. 0 l/h**
 - Information on the low value of the flowmeter. This part is grayed out (not accessible), it's frozen at (**0**).
- **Flowrate max. 100,00 l/h**
 - Enter the high value of the flowrate. Here the current value is (**100.00**). Press to open the numeric keyboard and enter the desired value.
- **Unit imp/l**
 - Pulse unit selection, on this selection button you will find the information of the currently selected unit (**imp/l**). Press to change it.
- **Volume per pulse ratio 1,0000 imp/l**
 - Enter the pulse weight for flow calculation. Here the current value is (**1,0000**). This value is directly related to your flowrate and installation, to calculate it, you must refer to the flowrate documentation. Press to open the numeric keyboard and enter the desired value.



To delete an input contact:

- You must select « NO » from the list of functions and save your configuration by pressing the "SAVE" button.

3) Menu « Configuration & Installation » - « TIMERS » [0331]



« TIMERS » menu will allow you to access the configuration of the operating clocks that can be used to control relay or parameters operation.

Press to open the followin screen.

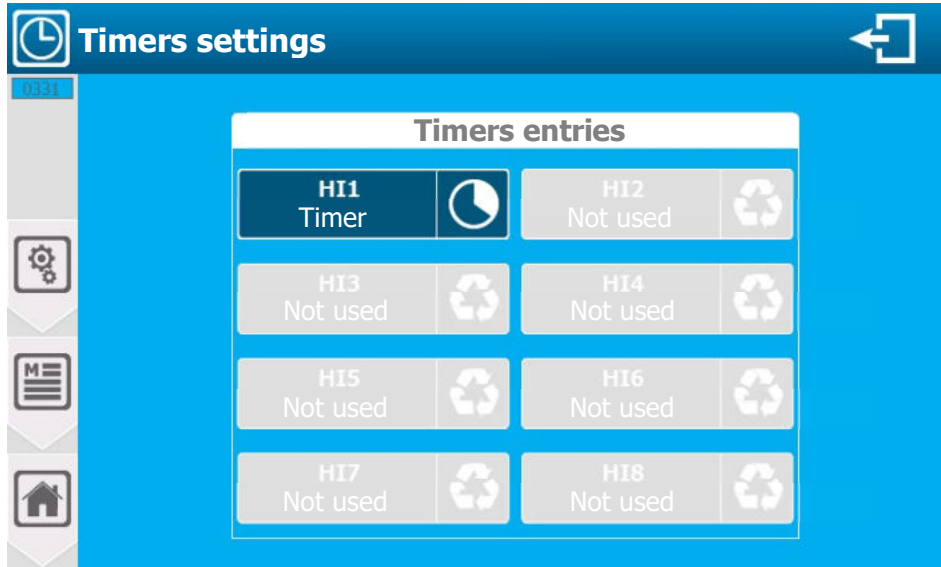

The screen shows the timers that are already configured and those not used. You can by pressing an already configured clock, changing its configuration, or pressing an unused clock, configure its installation.

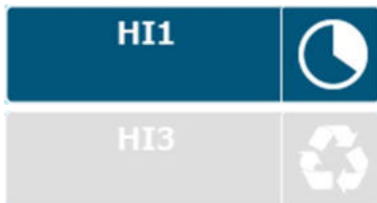

Timer already set.
Press to edit configuration.

Timer not used.
Press to edit configuration.



HI1 to HI8 timer identification.
In the control screens, timers will be identified by their Hix "code"

Example of timer configuration:



Press to open the following screen.

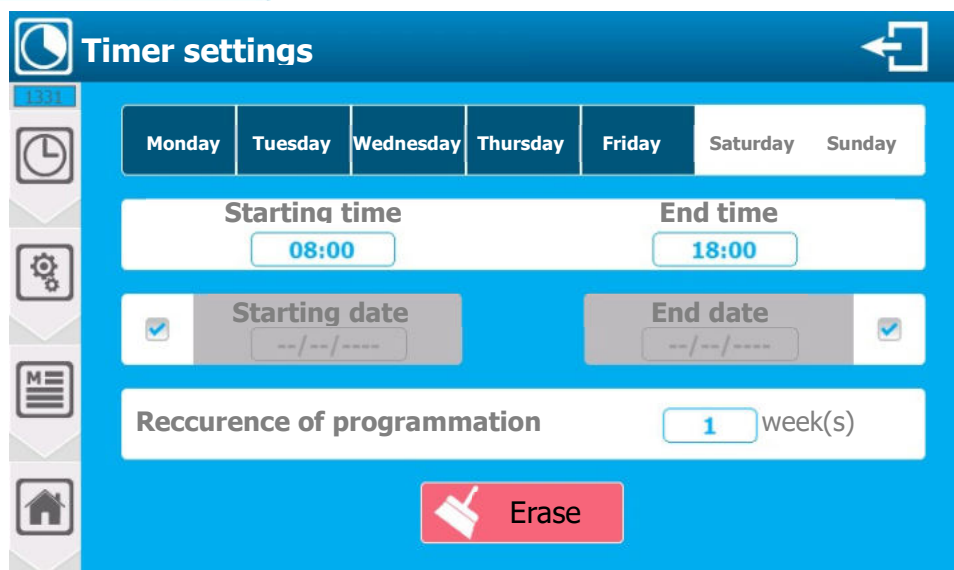

- **Monday – Tuesday – Wednesday – Thursday – Friday – Saturday – Sunday**
 - Selection of the day(s) of the week timer will be active. Type of "multiple" selection, press desired days to select/deselect. Here (**Monday – Tuesday – Wednesday – Thursday – Friday**) are selected.
- **Starting time 08:00 – End time 18:00**
 - Select time to start and end the time slot one after the other. Here the value is (**08:00**) & (**18:00**). Press Starting time and/or End time one after the other to open the numeric keyboard and enter the desired time.
- **Starting date --/--/---- End date --/--/---**
 - Select timer activation only in a period between two dates. Here no value entered (**--/--/----**) & (**--/--/---**), Both fields are disabled for a clock with no defined period.



To enable date management, the corresponding box must be unchecked

- **Recurrence of programmation 1 week(s)**
 - Weeks recurrence selection. Here the value entered is (**1**), timer active every week. Type 2 for 1 week/2, 3 for 1 week/3 etc. Adjustment possible from **1 to 52**.
- **Erase**
 - Clears the time slot configuration.

4) Menu « Configuration & Installation » - « MEASURES & CALCULATIONS » [0431]

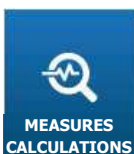

« MEASURES & CALCULATIONS » menu will allow you to access the configuration of the measurements managed and displayed by the controller. This can be a "simple" measurement with a sensor or a calculation with multiple sensors. The device will give you a list of possible parameters based on the sensors you have configured previously. Press to open the following screen.



If the option « **Create a parameter automatically for each sensor** » is enabled when opening this screen, the list of parameters "simple" will already be present.



The order of the parameters is completely independent of the order of the sensor. If the option « **Create a parameter automatically for each sensor** » is enabled, the order of the parameters created will correspond to the order in which you have added and configured your sensors.

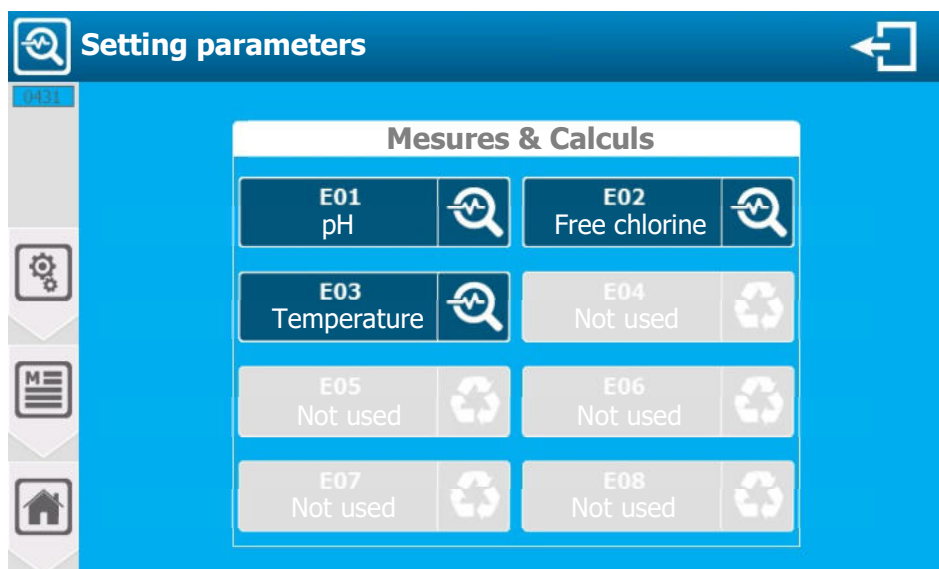



The screen shows the parameters that are already configured and those not used. You can, by pressing a parameter already configured; change its configuration, or by pressing a parameter not used configure it.

E01		Parameter already configured. Press to edit its configuration.
E04		Parameter not used. Press to start its configuration.

 E01 to E08 Parameters identification.
In the control screens, the parameters will be identified by their E0x "code".

➤ **Common symbols**

	Parameter Not used		Measured parameter		Calculated parameter
---	--------------------	---	--------------------	---	----------------------

a) Parameter configuration [1431]

E04 Not used		Press to open the following screen.
------------------------	---	-------------------------------------



- **E04 Measure None**
- Selection of the parameter type, on this selection button we find the information of the parameter in the process of modification (**E04**) and the measurement type currently selected (**None**). Press to change it.

 The choice of measurement is directly related to the sensors installed and configured. The controller will only give you measurements with the configured sensors.

 When selecting the measurement, the controller will automatically complete the parameter configuration files using the information from the first compatible sensor available in its list. You can change this configuration if necessary.

b) Parameter configuration - « simple »

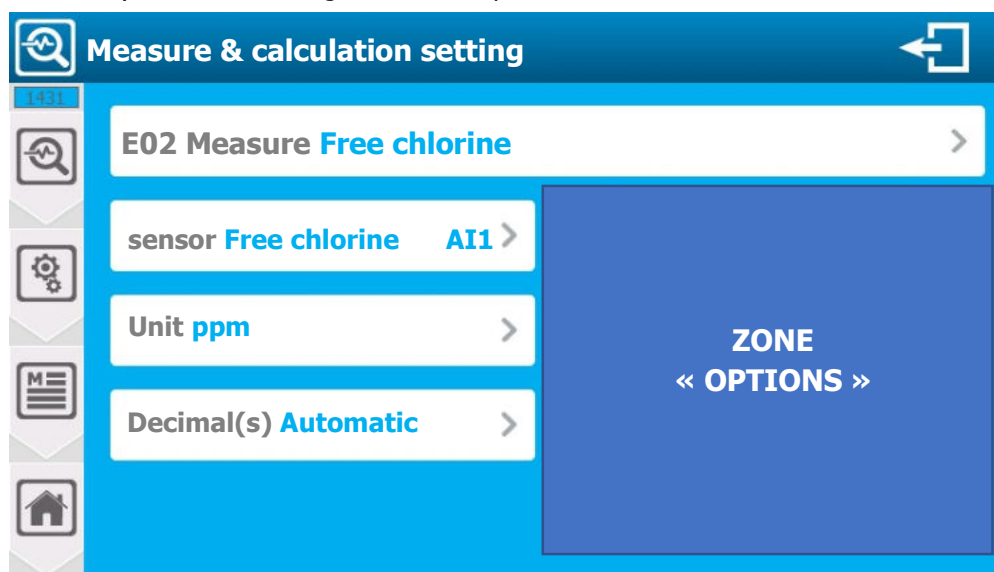

« Base » screen of a parameter configuration. Depending on the parameter chosen (measured, calculated, compensated...) additional configuration options are added on the right track (ZONE "Options").

- **E02 Measure Free chlorine**
 - Parameter type selection, on this selection button we find the information of the parameter in the process of modification (**E02**) and the currently selected measurement type (**Free chlorine**). Press to change it.



The choice of measurement is directly related to the sensors installed and configured. The controller will only give you measurements with the configured sensors.

- **Sensor Free chlorine AI1**
 - Select the type of sensor to associate to the measurement, on this selection button we find the information of type (**Free chlorine**) and input (**AI1**). Press to change it.



The choice of the sensor is directly related to the type of measurement. The controller will only offer you the sensors compatible with the selected measurement.

- **Unit ppm**
 - Sensor unit measurement selection, on this selection button we find the information of the currently selected unit (**ppm**). Press to change it.
- **Decimal(s) Automatic**
 - Select the number of decimals to display, on this selection button we find the number information (**Automatic**). Press to change it.



Controller will give you the list of possible decimals.



To delete a measurement or calculation:

- You must select « NO » in the measurement type and save your configuration by pressing the "SAVE" button.

c) pH parameter options

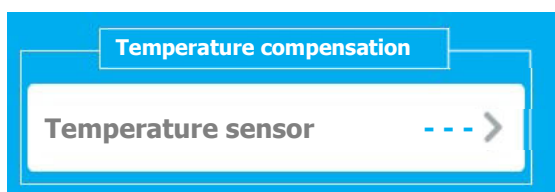

- **Temperature sensor**
 - pH measurement is dependent on the temperature of the environment. Here you have the possibility to select a temperature sensor (if there is one installed) which will be used to adapt the measurement made in correlation with the temperature of the environment. The pH value displayed will then be the compensated value and no longer the measured value.
 - On this selection button we find the information of the used entry, here none (- - -). Press to change it.

d) Conductivity parameter options

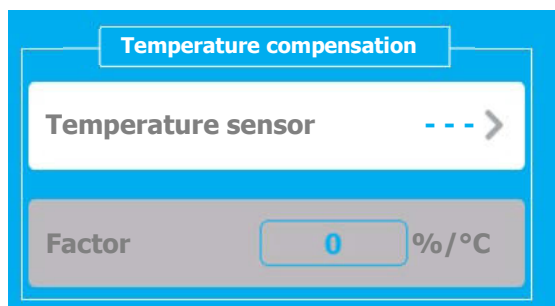

- **Temperature sensor**
 - Conductivity measurement is dependent on the temperature of the environment. Here you have the possibility to select a temperature sensor (if there is one installed) which will be used to adapt the

measurement made in correlation with the temperature of the environment. The conductivity value displayed will then be the compensated value and no longer the measured value.

- On this selection button we find the information of the used entry, here none (- - -). Press to change it.



Make sure that your sensor doesn't already have internal temperature compensation. Adding a new compensation here would distort the measurement.

- **Factor 0 %/°C**
 - If you select a temperature sensor, the compensation factor input becomes active and you must enter the desired value. Press to open the numeric keyboard and enter the desired value. Adjustment possible from **-99,0 to + 99,0 %/°C**.

e) Salinity calculation options

If your installation has:

- Conductivity sensor
⇒ **Salinity** calculation

- **Temperature sensor**
 - See conductivity parameter
- **Factor 0 %/°C**
 - See conductivity parameter.

f) TDS calculation options

If your installation has:

- Conductivity sensor
⇒ **Salinity** calculation

- **Temperature sensor**
 - See conductivity parameter
- **Factor 0 %/°C**
 - See conductivity parameter
- **Factor TDS 0 %/°C**
 - The TDS calculation is based on a factor that you need to fill in here. Press to open the numeric keyboard and enter the desired value. Adjustment possible from **1,0 to 444,0 %**.

g) Free chlorine, Active chlorine, and Active bromine calculation options

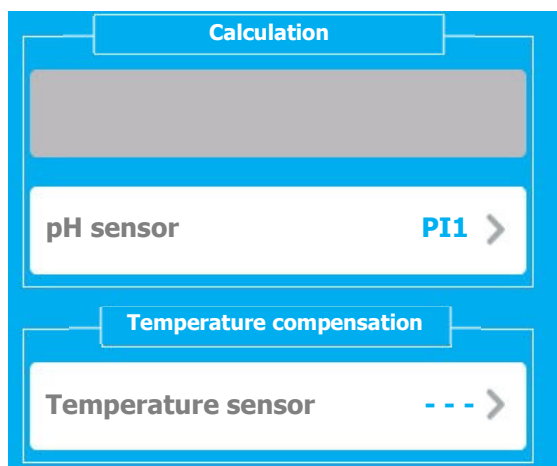

If your installation has:

- **Free chlorine** and **pH** sensor
⇒ **Active chlorine** calculation
- **Active chlorine** and **pH** sensor
⇒ **Free chlorine** calculation
- **Free bromine** and **pH** sensor
⇒ **Active bromine** calculation

➤ **pH sensor PI1**

- Select the pH sensor to be associated with the calculation, on this selection button we find the selected sensor information (**PI1**). Press to change it.

➤ **Temperature sensor**

- pH measurement is dependent on the temperature of the environment. Here you have the possibility to select a temperature sensor (if there is one installed) which will be used to adapt the measurement made in correlation with the temperature of the environment. The pH value displayed will then be the compensated value and no longer the measured value.
- On this selection button we find the information of the used entry, here none (**- - -**). Press to change it.



It's possible to select a temperature compensation sensor to adjust the pH value to the temperature of the environment. This sensor is "Optional" and isn't included in the "pure" calculation.

h) Chloramine calculation options

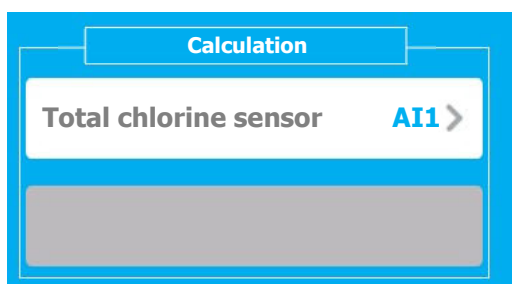

If your installation has:

- **Free chlorine** and **total chlorine**
⇒ **Chloramine** calculation

➤ **Total chlorine sensor AI1**

- Select the Total chlorine sensor to be associated with the calculation, on this selection button you will find the selected sensor information (**AI1**). Press to change it.

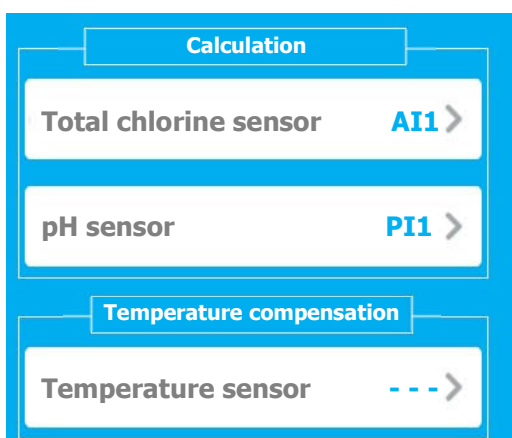

If your installation has:

- **Active chlorine, Total chlorine** and **pH** sensor
⇒ **Chloramine** calculation

➤ **Total chlorine sensor AI1**

- Select the Total chlorine sensor to be associated with the calculation, on this selection button you will find the selected sensor information (**AI1**). Press to change it.

➤ **pH sensor PI1**

- Select the pH sensor to be associated with the calculation, on this selection button we find the selected sensor information (**PI1**). Press to change it

➤ **Temperature sensor**

- pH measurement is dependent on the temperature of the environment. Here you have the possibility to select a temperature sensor (if there is one installed) which will be used to adapt the measurement made in correlation with the temperature of the environment. The pH value displayed will then be the compensated value and no longer the measured value.
- On this selection button we find the information of the used entry, here none (- - -). Press to change it.



It's possible to select a temperature compensation sensor to adjust the pH value to the temperature of the environment. This sensor is "Optional" and isn't included in the "pure" calculation.

5) Menu « Configuration & Installation » - « OUTPUTS » [0531]



« OUTPUTS » menu will allow you to access the configuration of relays and 4...20mA outputs that will be used.

Press to open the following screen.

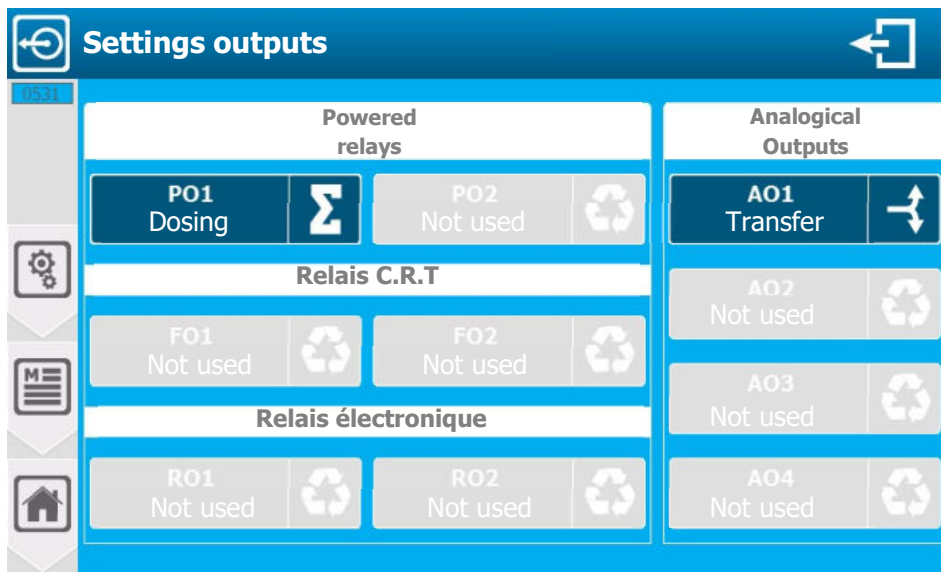

The screen shows the outputs that are already configured and those not used. You can, by pressing and already configured output, changing its configuration, or pressing an unused output, configure its installation.



PO1 & PO2 self-powered relay outputs, these outputs do not have Pulse Frequency Modulation (PFM).



FO1 & FO2 CRT potential-free relay outputs, these outputs have Pulse Frequency Modulation (PFM), but limited at 180 pulses/minute.



RO1 & RO2 Electronic relay outputs (simple contact), these outputs have Pulse Frequency Modulation (PFM), programmable up to 500 pulses/minute.

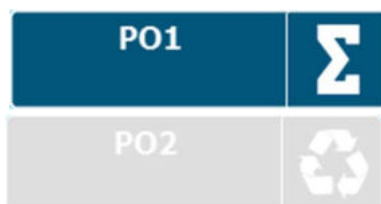

Output already configured.
Press to edit its configuration.

Output not used.
Press to configurate.



For your comfort, you will find the notation of the outputs POx, FOx, ROx, AOx screen-printed in front of the connection terminal block of your device.

➤ **Common symbols**



Not used output



Timer controlled output



Dosage controlled output



State controlled output (contact)



Alarm controlled output



4...20mA transfer output

a) Relay outputs in dose (On / Off) control mode [1531]

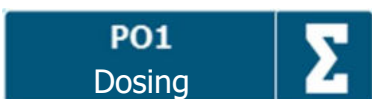

Example with editing a relay in dosage mode.
Press to open the following screen

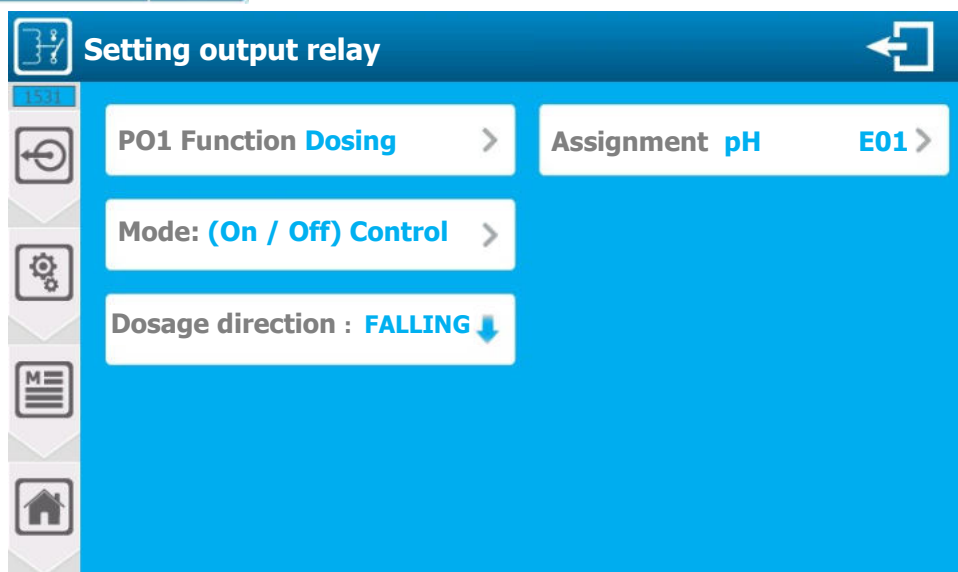

- **PO1 Function Dosing**
 - Output relay operation mode selection, on this selection button we find the information of the output being modified (**PO1**) and the function currently selected (**Dosing**). Press to change it.
- **Assignment pH E01**
 - Selection of the parameter to which this relay is attached, on this selection button we find the information of type of parameter (**pH**) and its « code » (**E01**). Press to change it.
- **Mode (On / Off) Control**
 - Dose mode selection, on this selection button you will find the selected mode information (**(On / Off) Control**). Press to change it.
- **Dosage direction FALLING**
 - Dosage direction choice, on this selection button we find the information of the selected dosage direction (**FALLING**).
Press to toggle the mode from **RISING** to **FALLING** and change the dosage direction.



- To delete a relay output :
You must select « NO » in the relay function and save your configuration by pressing the "SAVE" button

b) Relay outputs in PWM (Pulse Width Modulation) dosing mode [1531]

- **PO1 Function Dosing**
 - See (On/Off) Control dosing mode
- **Assignment pH E01**
 - See (On/Off) Control dosing mode
- **Mode PWM (Pulse Width Modulation)**
 - Dosing mode selection, on this selection button we find the selected mode information (**PWM (Pulse Width Modulation)**). Press to change it.
- **Dosage direction FALLING**
 - See (On/Off) Control dosing mode
- **Cycle time : 20 second(s)**
 - Selection of the value corresponding to the complete processing time of your basin. Here the current value is (**20**). Press to open the numeric keyboard and enter the desired value.
Possible adjustment from **10 to 1800** second(s)
- **Minimum duration : 3 second(s)**
 - Enter the value of the minimum allowed time to switch the dosing relay, this allows a longer lifespan of the relay as short switches aren't allowed. The time of the need will then cumulate until this value is reached. Here the value is (**3**).
Press to open the numeric keyboard and enter the desired value.
Possible adjustment from **0 to 5** second(s)
- **Dosing range - Minimum : 0 %**
 - Enter the value of the requirement as a minimum % of the dosing range for which this relay will work. Here the current value is (**0**). Press to open the numeric keyboard and enter the desired value.
Possible adjustment from **0 to 100** %.
- **Dosing range - Maximum 100 %**
 - Enter the value of the requirement as a maximum % of the dosing range for which this relay will work. Here the current value is (**0**). Press to open the numeric keyboard and enter the desired value.
Possible adjustment from **0 to 100** %.
- **Dosing range – Keep active after**
 - Relay operation mode selection when the need for dosing is out of the range entered. This option is active only when the maximum dosing range is less than 100%.
If this option is enabled (checkbox checked) the relay will continue dosing at 100% beyond its programmed range, otherwise it will stop. Press to switch **ON** to **OFF** mode.

- **Delete & Save.**
 - See (On/Off) Control dosing mode



Dosing range:

The percentage of the dosing range corresponds to the percentage of the relay dosing need. This function can be activated for example if you use two relays for dosing a single parameter. It's possible to program the first relay for a holding with for example an active dosage between 30 and 100% and the second for a more powerful dosage between 30 and 100%.

It's therefore possible to use a low flow pump for maintaining dosing and one with a higher flow rate for more powerful dosing when the need is great.



For a programmed range of 0 to 50%, the relay power will vary from 0 to 100% between these two bounds. When the dosage need is 50% the relay will be at 100% of its dosage power.

Example with dosing hold option disabled on relay 1

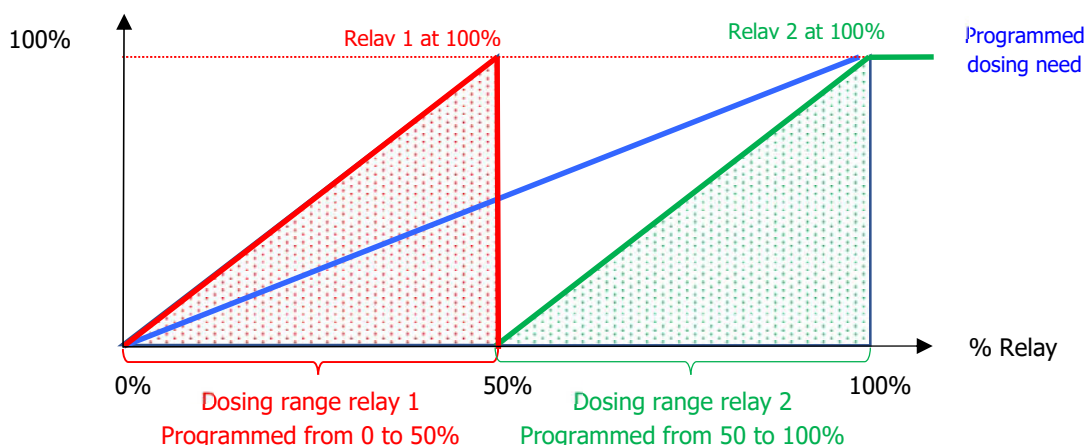

c) Relay outputs in PFM (Pulse Frequency Modulation) dosing mode [1531]



- **PO1 Function Dosing**
 - See (On/Off) Control dosing mode
- **Assignment pH E01**
 - See (On/Off) Control dosing mode
- **Mode PFM (Pulse Frequency Modulation)**
 - Dosing mode selection, on this selection button we find the selected mode information (**PFM (Pulse Frequency Modulation)**). Press to change it.

- **Dosage direction FALLING**
 - See (On/Off) Control dosing mode
- **PFM frequency: 180** pulse/min
 - Enter the value corresponding to the number of pulses per minute to be generated. Here the value is (180). Press to open the numeric keyboard and enter the desired value.
Possible adjustment FO1 & FO2 outputs from **1 to 180** pulse/min
Possible adjustment RO1 & RO2 outputs from **1 to 500** pulse/min
- **Dosing range**
 - See (On/Off) Control dosing mode.
- **Delete & Save**
 - See (On/Off) Control dosing mode

d) Relay outputs in Alarm mode [1531]



Example with creation of a relay in alarm mode.
Press to open following screen.

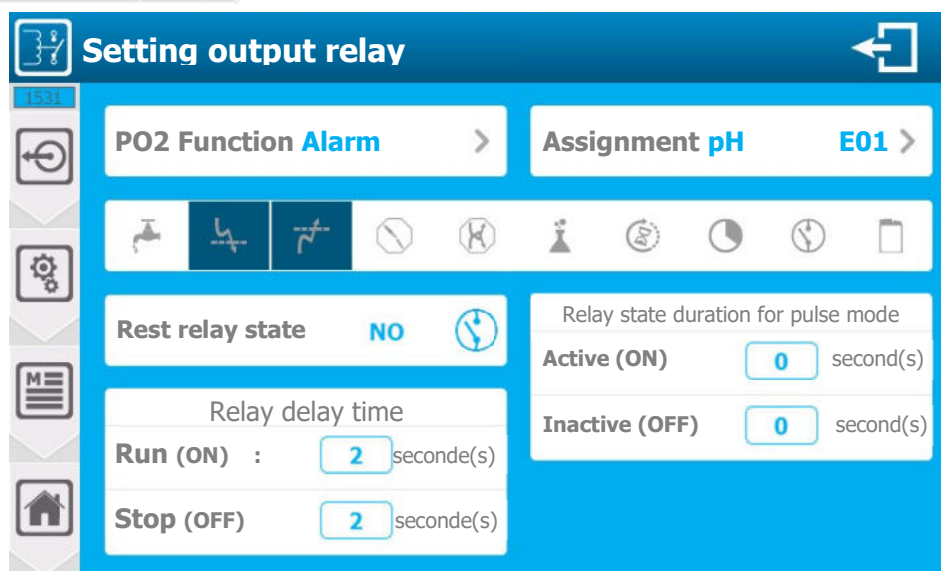

- **PO2 Function Alarm**
 - Output relay operation mode selection, on this selection button we find the information of the output being modified (PO2) and the function currently selected (Alarm). Press to change it.
- **Assignment pH E01**
 - Selection of the parameter to which this relay is attached, on this selection button we find the information of the parameter type (pH) and its « code » (E01). Press to change it.
- **Selection of alarms to be taken into account to activate this output:**
 - Selection of alarm to be considered. « Multiple » selection possible, press desired alarms to select/deselect. here (Low threshold – High threshold) are selected.



Alarms list in order of icons :

- Water circulation – Low threshold – High threshold – Out of order sensor – Unstable sensor – Overdosage – Active polarization – Active timer – Active RIC – Tank bottom
- **Rest relay state NO**
 - Choice of resting state to take into account, this check box contains the information currently selected (NO). Press to switch mode to NO (Normally Open) or NC (Normally Close).

- **Relay delay time - Run (ON) : 2 second(s)**
 - Enter the wait time value before the alarm is taken into account. Here the value is (2). Press to open the numeric keyboard and enter the desired value. Possible adjustment from 0 to 240 second(s).
- **Relay delay time - Stop (OFF): 2 second(s)**
 - Enter the wait time value before the disappearance of the alarm is taken into account. Here the value is (2). Press to open the numeric keyboard and enter the desired value. Possible adjustment from 0 to 240 second(s).
- **Relay state duration for pulse mode - Active (ON): 0 second(s)**
 - Enter the time value during which the relay will be active in the alarm time slot. Here the value is (0). Press to open the numeric keyboard and enter the desired value. Possible adjustment from 0 to 240 second(s).
- **Relay state duration for pulse mode – Inactive (OFF): 0 second(s)**
 - Enter the time value during which the relay will be inactive in the alarm time slot. Here the value is (0). Press to open the numeric keyboard and enter the desired value. Possible adjustment from 0 to 240 second(s).



Pulse mode time:

This setting allows pulses to be generated throughout the duration of the alarm. For example, if the two values entered are 1 second, the relay will open 1 second and close 1 second repeatedly throughout the alarm.



To delete a relay output:

You must select « NO » in the relay function and save your configuration by pressing the "SAVE" button.

e) Relay outputs in State mode [1531]

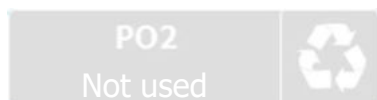

Example with creation of a relay in State mode.
Press to open the following screen.

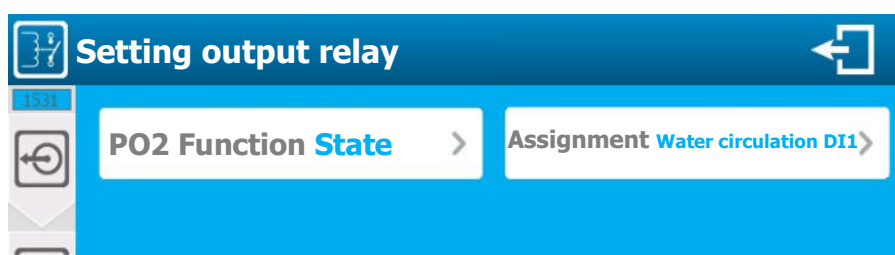

- **PO2 Function State**
 - Output relay operation mode selection, on this selection button we find the information of the output being modified (PO2) and the function currently selected (State). Press to change it.
- **Assignment Water circulation DI1**
 - Selection of the contact to which this relay is attached, on this selection button we find the information of the type of contact (Water circulation) and its « code » (DI1). Press to change it.
- **For all other parameters:**
 - See relay configuration in alarm mode.

f) Relay output in Timer mode [1531]

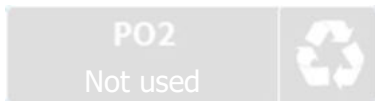

Example with creation of a relay in Timer mode.
Press to open following screen.

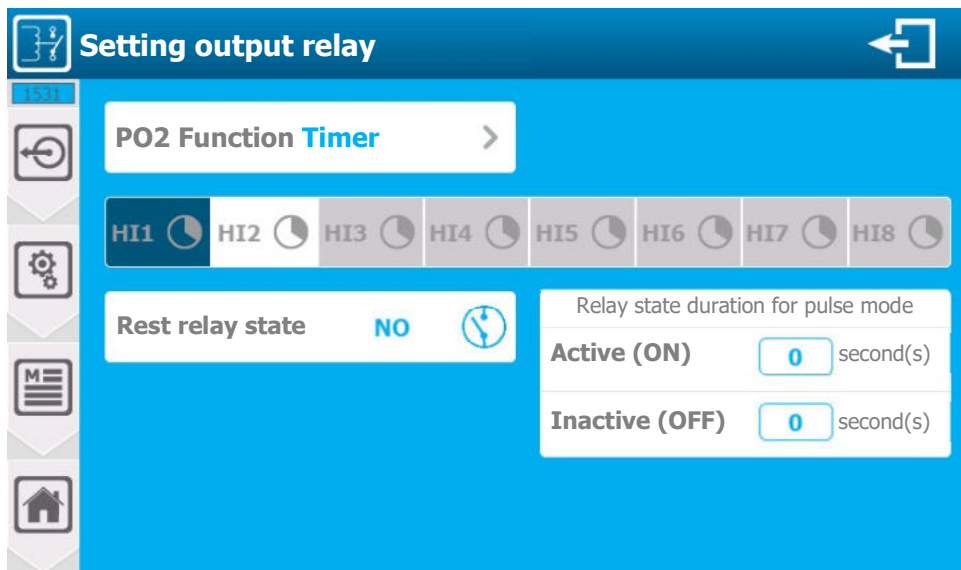

- **PO2 Function Timer**
 - Output relay operation mode selection, on this selection button we find the information of the output being modified (**PO2**) and the function currently selected (**Timer**). Press to change it.
 - Selection of alarm to be considered. « Multiple » selection possible, press desired alarms to select/deselect. Here (**HI1**) is selected.
- **For all other parameters:**
 - See relay configuration in alarm mode.

g) Outputs 4...20mA in dosage mode [2531]



Example with creation of a 4...20mA output in dosage mode.
Press to open following screen.

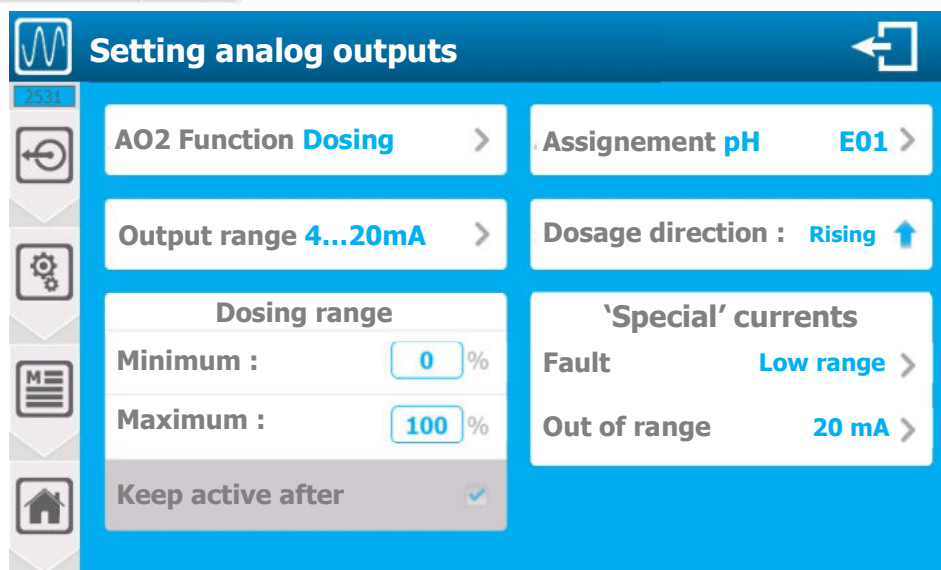

- **AO2 Function Dosing**
 - Output 4...20mA operation mode selection, on this selection button we find the information of the output being modified (**AO2**) and the function currently selected (**Dosing**). Press to change it.
- **Assignment pH E01**
 - Selection of the parameter to which this output 4...20mA is attached, on this selection button we find the configuration type information (**pH**) and its « code » (**E01**). Press to change it.
- **Output range 4...20mA**
 - Selection of the current range generated in dosing mode; on this selection button you find the selected range information (**4...20mA**). Press to change it.
- **Dosage direction Rising**
 - Choice of dosage direction, on this selection button we find the information of the selected dosage direction (**RISING**). Press to toggle the mode from **RISING** to **FALLING** and change the dosage direction
- **Dosing range**
 - See relay configuration in PWM dosage mode
- **"Special" current**
 - This option isn't necessarily present, it's activated in the "OPTIONS" of the installer menu.
- **Fault Low range**
 - Selection of the current that will be applied on the output in case of fault encountered, on this selection button we find the selected current information (**Low range**). Press to change it.



Low range = 4mA if range 4...20mA selected; 0mA if range 0...20mA selected.
0mA = 0mA
2,6mA = 2,6mA

- **Out of range 20mA**
 - Selection of the current that will be applied on the output in case of exceeding the selected operating range, on this selection button we find the selected current information (**20mA**). Press to change it.



Maximum = higher 22mA
20mA = 20mA
20,8mA = 20,8mA



To delete a 4...20mA output:

- You must select « NO » in the 4...20mA output function and save your configuration by pressing the "SAVE" button.

h) Output 4...20mA in Transfer mode [2531]

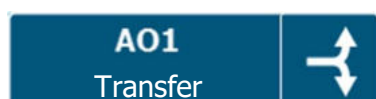

Example with creation of a 4...20mA output in transfer mode.
Press to open the following screen.

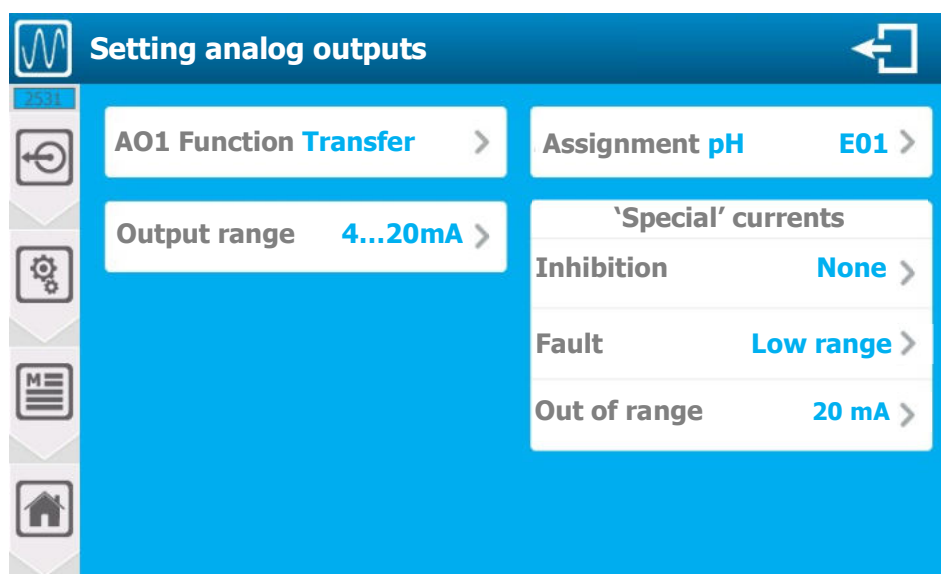

- **AO1 Function Transfer**
 - Output 4...20mA operation mode selection, on this selection button we find the information of the output being modified (**AO1**) and the function currently selected (**Transfer**). Press to change it.
- **Assignment pH E01**
 - Selection of the parameter to which this output 4...20mA is attached, on this selection button we find the configuration type information (**pH**) and its « code » (**E01**). Press to change it.
- **Output range 4...20mA**
 - Selection of the current range generated in dosing mode; on this selection button you find the selected range information (**4...20mA**). Press to change it.
- **"Special" current**
 - This option isn't necessarily present, it's activated in the "OPTIONS" of the installer menu.
- **Inhibition None**
 - Selection of the current that will be applied when the parameter is "stopped" or paused on a water flow fault, on this selection button we find the selected current information (**None**). Press to change it.



None = The output always transfers the equivalent of 4...20mA of the parameter value.
Low range = 4mA if range 4...20mA selected; 0mA if range 0...20mA selected.
0mA = 0mA
3,4mA = 3,4mA

➤ **Fault Low range**

- Selection of the current that will be applied on the output in case of fault encountered, on this selection button we find the selected current information (**Low range**). Press to change it.



Low range = 4mA if range 4...20mA selected; 0mA if range 0...20mA selected.
0mA = 0mA
2,6mA = 2,6mA

➤ **Out of range 20mA**

- Selection of the current that will be applied on the output in case of exceeding the selected operating range, on this selection button we find the selected current information (**20mA**). Press to change it.



Maximum = higher 22mA
0mA = 20mA
20,8mA = 20,8mA



To delete a 4...20mA output :

- You must select « NO » in the 4...20mA output function and save your configuration by pressing the "SAVE" button.

6) Menu « Configuration & Installation » - « CONDITIONS » [0631]



« CONDITIONS » menu will allow you to access the configuration of the operating conditions that are used to control the parameters operation.

Press to open the following screen.

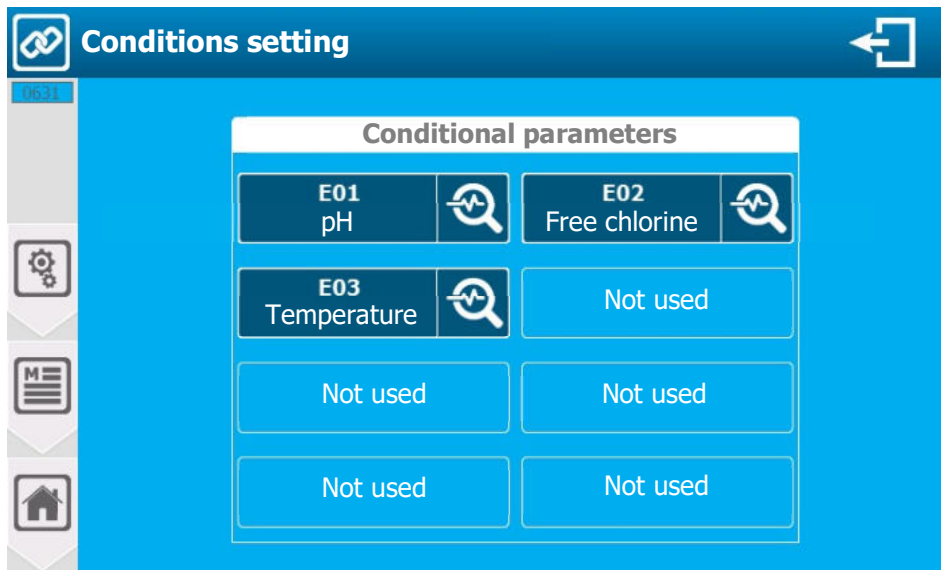

The screen displays the list of configured and conditionable parameters. You can, by pressing a used parameter, change the configuration of the applied conditions.

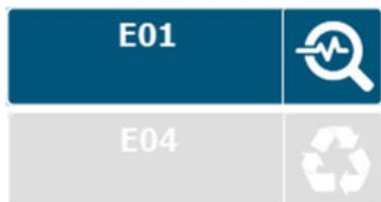

Type of parameter conditionable.
 Press to edit the configuration.

Parameter type inactive and not conditionable.

a) Setting the conditions of a parameter [2531]

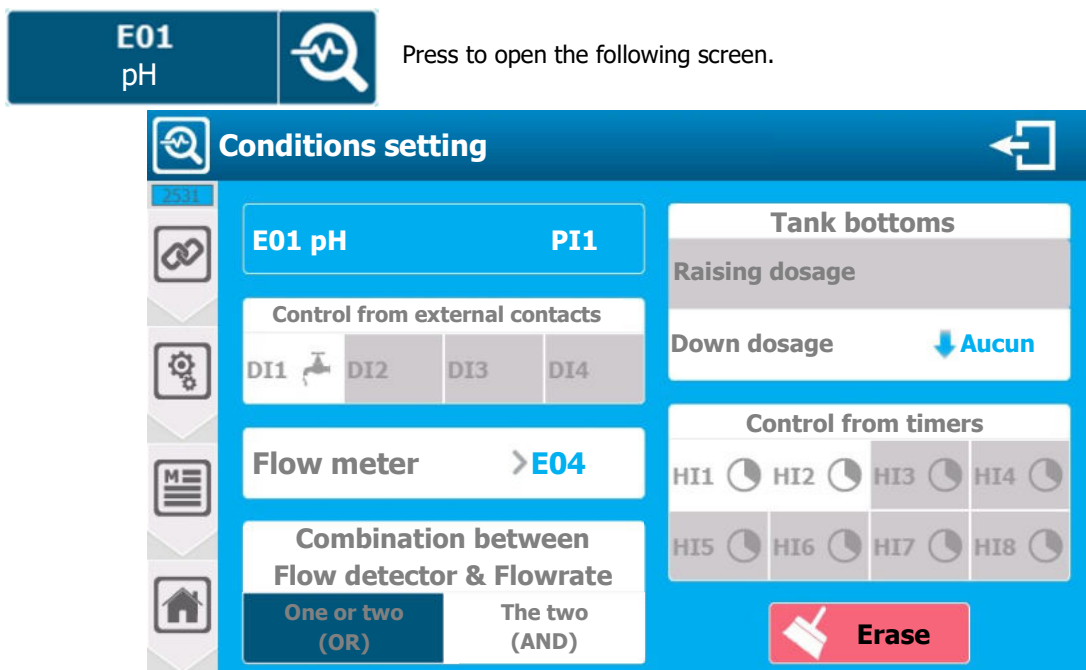

- **E01 pH PI1**
 - Parameter identification, we find the information of the parameter number (**E01**), of the type (**pH**) and associated main sensor input (**PI1**).

- **Control from external contacts**
 - Selection of the contact(s) to be taken into account, for the control of the parameter. "Multiple" selection, press the contact you want to associate to this parameter. Here no contact is selected.



Only configured contacts are selectable. Unconfigured contacts appear grayed out. Contacts are identified by the associated entry number (DIx) and an icon representing their function.

- **Flow meter **E04****
 - Selection of the flowmeter to be associated with the parameter, on this selection button you find the information of the input selected (**E04**). Press to select a flow meter.



The list of flowmeters depends on the configuration options. In case the option "Condition the flow rates only to the parameter" is disabled the list will be filled with flow parameters and flow sensors.

- **Combination between Flow detector & Flowrate**
 - When you select at least one contact and one flow meter, this option activates and allows you to define the combination of taking into account the information.

One or two (or): Active information = Parameter in pause
 All inactive information = Active parameter

The two (and): All active information = Parameter in pause
 Active information = Active parameter



This option isn't necessarily present, it's activated in the "OPTIONS" of the installer menu.

- **Tank bottoms**
 - To active this choice you must have:
 - Configured tank bottom contact or 4...20mA volume sensor
 - Relay output or 4...20mA configured in dosage assigned to the parameter.
 Depending on the dosage direction of the output assigned to the parameter, you can associate the desired tank bottom. Here only a dosing relay is associated to the parameter, with a falling dosage and (**None**) tank bottom is associated. Press to select one.
- **Control from timers**
 - Select timer(s) to be considered. Multiple selection type, press desired timers to select/deselect. Here (**None**) timer is selected.



Be careful, when you combine one or more timers, the operation of the parameter becomes dependant of the time slots.

Parameter is functional during the time slot.

Save:



- When a change is made, the "SAVE" button appears (floppy icon), you must save your configuration by pressing it.

7) Menu « Configuration des communications » - « COMMUNICATION » [0731]



See. Part 3 « DOC0461 - Communication programming instructions ODITOUCH ENG Rev1».

8) Menu « Configuration & Installation » - « RESET FACTORY » [0831]



« RESET FACTORY » menu will allow you to reset the regulator configuration by choosing some preset operating options.

Press to open the following screen.

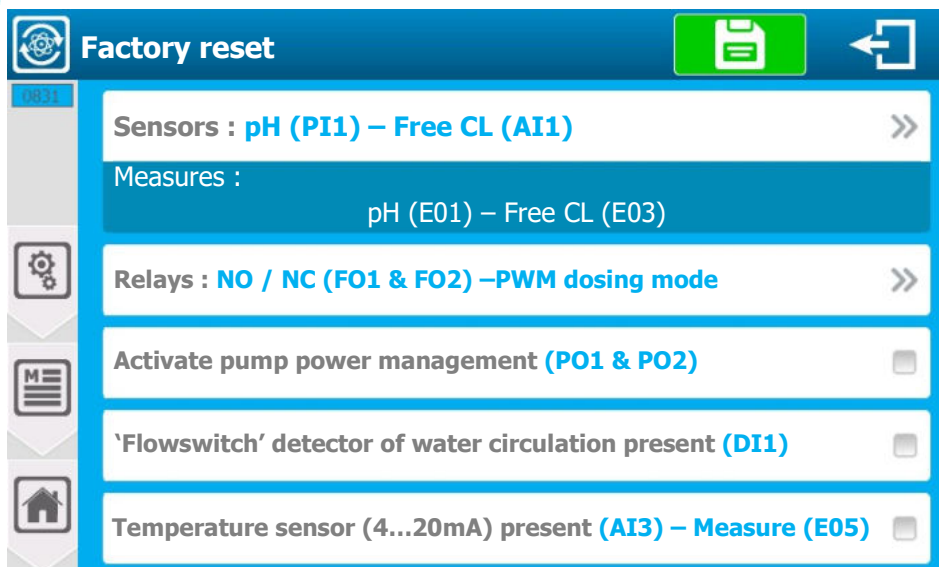

➤ **Sensors**

- Select desired sensor configuration from predefined configuration:
 - pH (PI1) – Free CI (AI1)
 - pH (PI1) – ORP (PI2) – Free CI (AI1)
 - pH (PI1) – Free CI (AI1) –Total CI (AI2)
 - pH (PI1) – ORP (PI2) – Free CI (AI1) –Total CI (AI2)

➤ **Relays**

- Select desired dose relay configuration from predefined configuration:
 - NO / NC (FO1 & FO2) – PWM dosing mode
 - Electronic (RO1 & RO2) – PFM dosing mode
 - Self-powered (PO1 & PO2) – ON / OFF dosing mode

➤ **Activate pump power management**

- When using C.R.T or electronic relays for dosage it's possible to use the two self-powered relays for supplying the pumps. To do this you must select this option.

- **'Flowswitch' detector of water circulation present**
 - If your installation has a water circulation sensor in the flow cells you can check this box to configure the input.
- **Temperature sensor (4...20mA) present**
 - If your installation has a teperature sensor you can check this box to configure the input.
- **Press « SAVE » button to validate your configuration.**
 - You may or may not reset the "User" or "Communication" configurations in addition to the "Installation & Settings" section.

Factory initialization
Check the configuration to initialize

User	<input type="checkbox"/>
Communication	<input type="checkbox"/>
Installation & Settings	<input checked="" type="checkbox"/>

NO

YES



It's also possible, if technical support is needed or requested, to reset only the communication or user part by checking only the box concerned.

VI. Programming screen « SETTINGS » [0021]

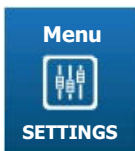

« SETTINGS » menu will allow you to access the settings of your configuration, you must have finished the "INSTALLATION" part before making the "SETTINGS". Press to open the following screen.

« Settings » menu

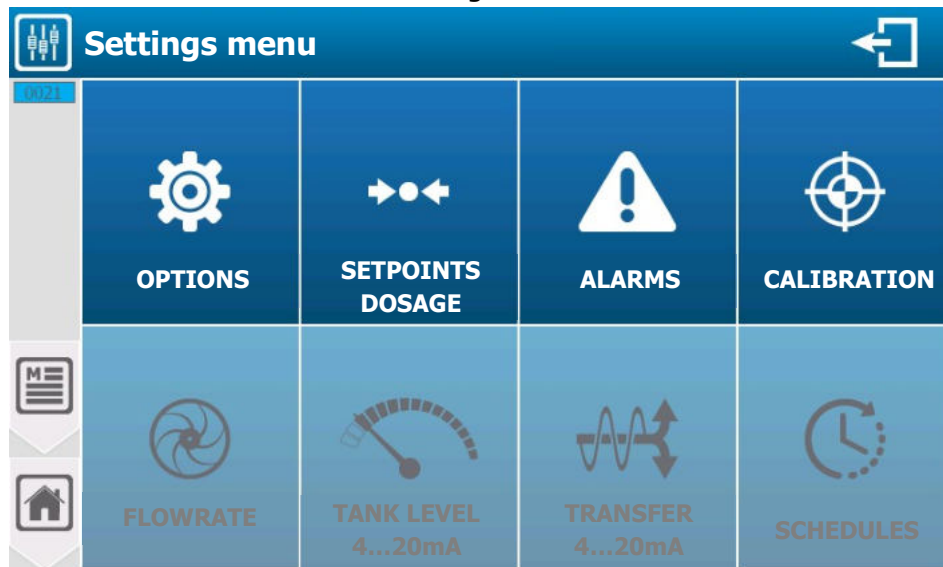

« Options » menu of the « Settings » menu can be locked by the installer.

1) Menu « Settings » - « OPTIONS » [0121]



« OPTIONS » menu will allow you to access the options available in the setting part.

Press to open the following screen.

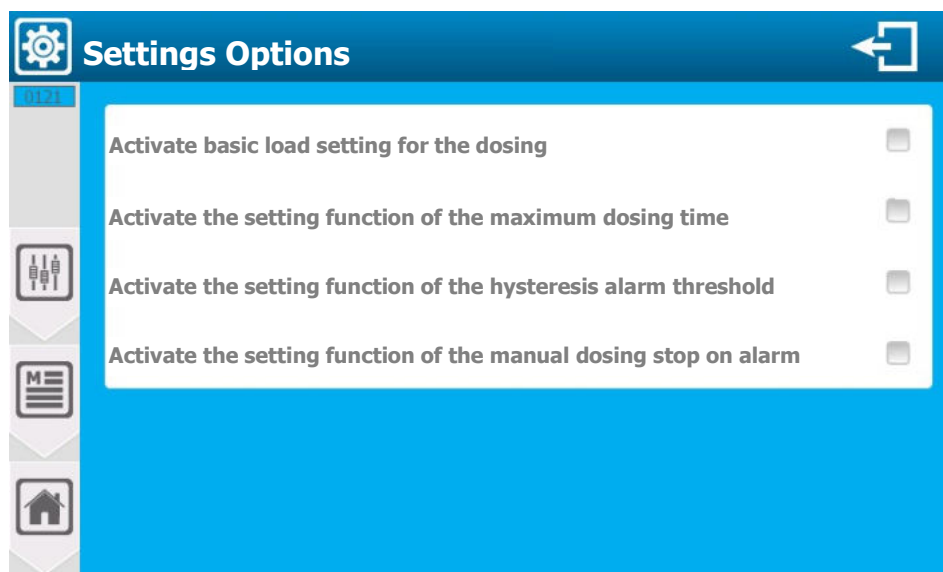

- **Active basic load setting for the dosing**
 - Allows manual adjustment of base load on dosage.
- **Active the setting function of the maximum dosing time**
 - Allows manual adjustment of dosage time count threshold.
- **Active the setting function of the hysteresis alarm threshold**
 - Allows manual setting of alarm hysteresis threshold.
- **Active the setting function of the manual dosing stop on alarm**
 - Allows complete manual setting of stop dosage on alarm.

2) Menu « Settings » - « Setpoint & dosage » [0221]



« Setpoint & dosage » menu will allow you to adjust the operation mode of the dosage plus setpoint of the parameters.

Press to open the following screen.

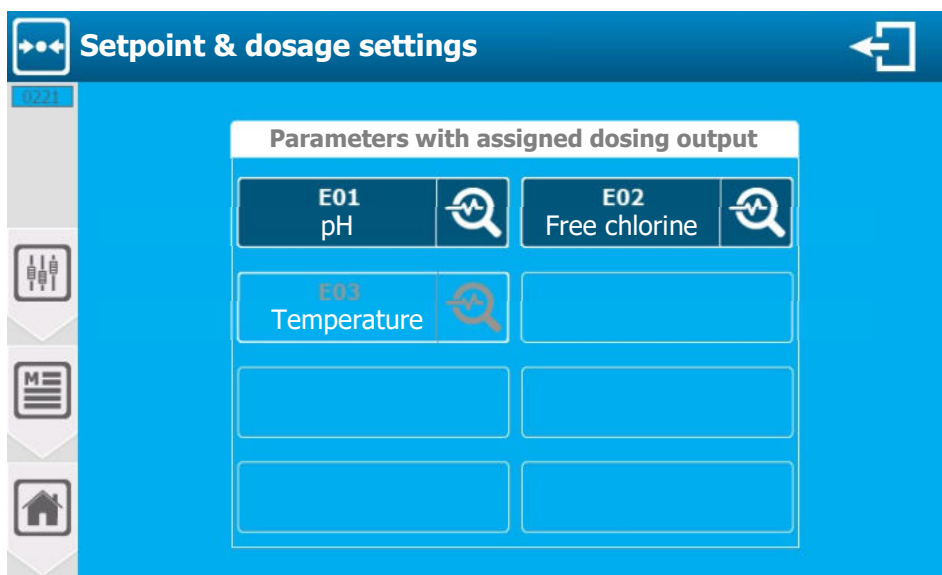

The screen presents the parameters that are configured. You can, by pressing an active parameter, configure the dosage.



Parameter type with dosage output affected.
Press to create or edit dosage configuration.

Parameter type without dosage output affected.

Parameter isn't configured.



E01 to E08 Identifying parameters.

a) Dosage mode – Hysteresis [1221]

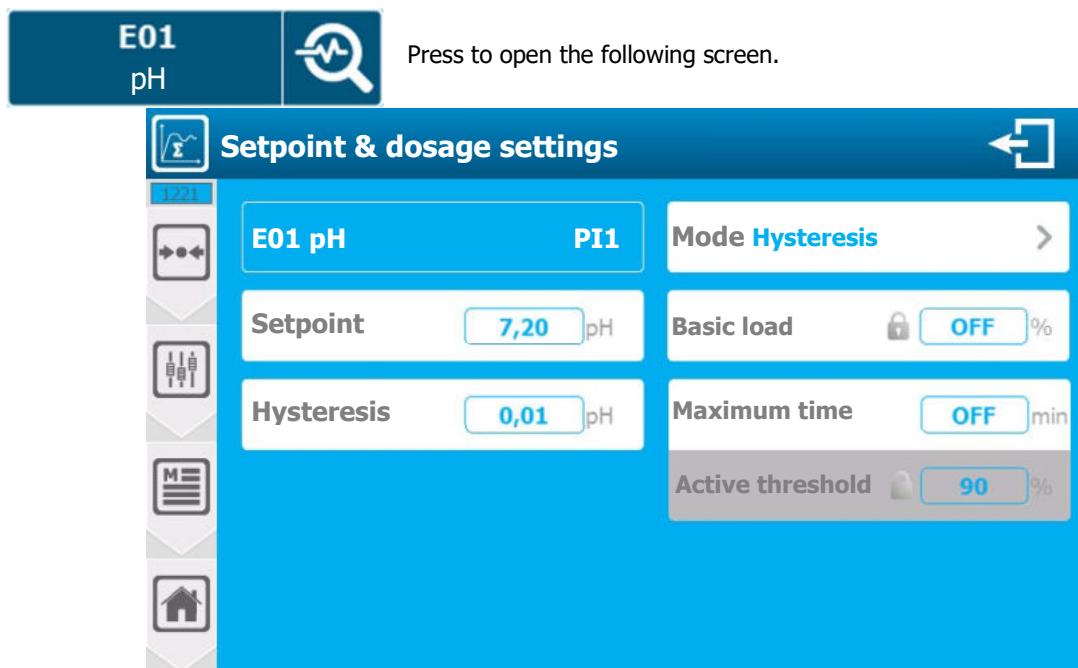

When the dosing direction of the channel is configured in downstream mode, as soon as the error (measurement – setpoint) is greater than the hysteresis value, the regulation requirement is 100%.

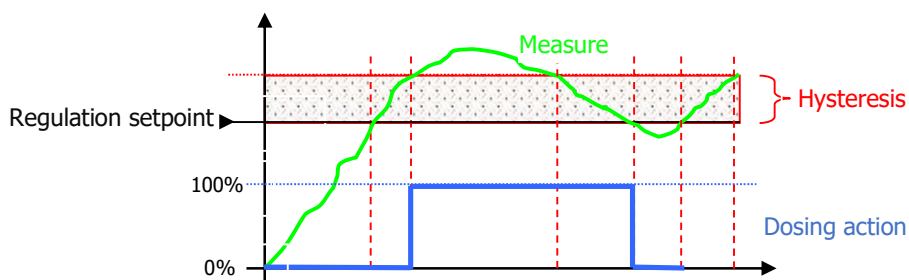

When the dosing direction of the channel is configured in upstream mode, as soon as the error (setpoint – measurement) is greater than the hysteresis value, the regulation requirement is 100%.

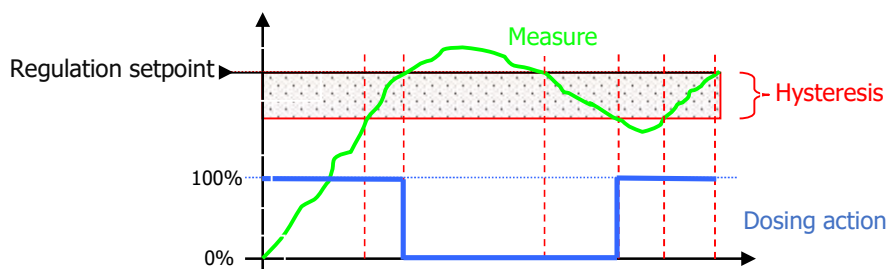

- **E01 pH PI1**
 - Parameter identification, includes information on parameter number (**E01**), type (**pH**) and associated main sensor input (**PI1**)
- **Mode Hysteresis**
 - Dosage mode selection, on this selection button we find the selected mode information (**Hysteresis**). Press to modify it.
- **Setpoint 7,20 pH**
 - Enter the setpoint value. Here the value is (**7,20**).
 - Press to open the numeric keyboard and enter the desired value.
- **Hysteresis 0,10 pH**
 - Enter the hysteresis value. Here the value is (**0,10**).
 - Press to open the numeric keyboard and enter the desired value.

- **Basic load OFF %**
 - Enter the base load value. Here it's disabled, current value is (OFF). Press to open the numeric keyboard and enter the desired value.



This setting is only available if the unlock option is enabled in the setting options.



Be careful, the basic load is a permanent dosage power regardless of the dosage need. This function is to be used with great care to avoid overdosage.

- **Maximum time OFF min**
 - Enter the maximum dosage time value. Here it's disabled, current value is (OFF). Press to open the numeric keyboard and enter the desired value.
- **Activation threshold 90 %**
 - Enter the dosage power from which the dosage time is counted. Here it's set automatically according to the dosage mode at (90). Press to open the numeric keyboard and enter the desired value.



This setting is only available if the unlock option is enabled in the setting options.

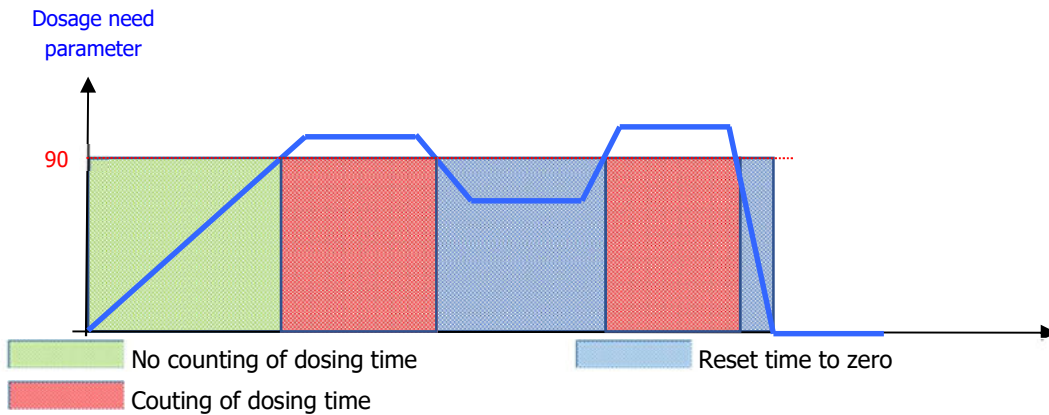

Save:

- When a change is made, the "SAVE" button appears (floppy icon), you must save your configuration by pressing it.

b) Dosage mode – Threshold [1221]

E01
pH

Press to open following screen.

Setpoint & dosage settings ←

E01 pH

PI1

Mode Threshold >

High threshold ↓ 7,20 pH

Low threshold ↑ 7,00 pH

Basic load OFF %

Maximum time OFF min

Active threshold 90 %

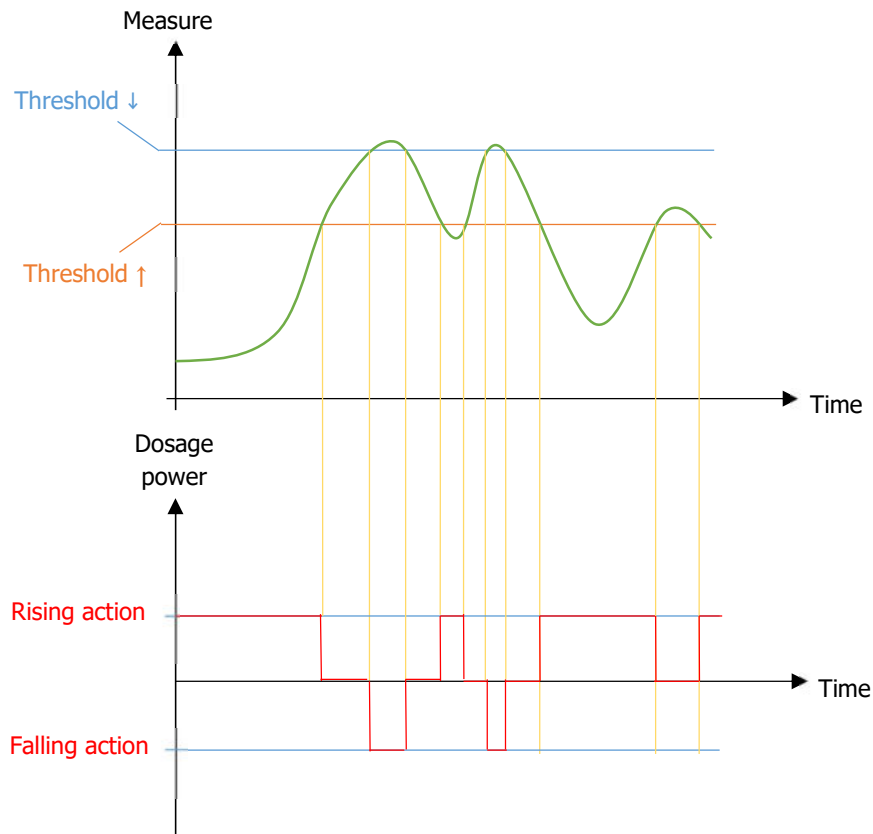

- **E01 pH PI1**
 - Parameter identification, includes information on parameter number (**E01**), type (**pH**) and associated main sensor input (**PI1**)
- **Mode Threshold**
 - Dosage mode selection, on this selection button we find the selected mode information (**Threshold**). Press to modify.
- **High threshold 7,20 pH**
 - Enter the high threshold value. Here the value is (**7,0**). Press to open the numeric keyboard and enter the desired value.
- **Low threshold 7,00 pH**
 - Enter the low threshold value. Here the value is (**7,2**). Press to open the numeric keyboard and enter the desired value.
- **Basic load OFF % - Maximum time OFF min – Activation threshold 90 %**
 - See Hysteresis dosing mode in previous part.

Save:



- When a change is made, the "SAVE" button appears (floppy icon), you must save your configuration by pressing it.

c) Dosage mode – P.I.D [1221]

E01
pH



Press to open following screen.

Setpoint & dosage settings

E01 pH **PI1** **Mode P.I.D**

Setpoint 7,20 pH **Basic load** OFF %

Proportional 1,40 pH **Maximum time** OFF min

Dead band 0,01 pH **Activ threshold** 90 %

Integral OFF s

Derivate OFF s

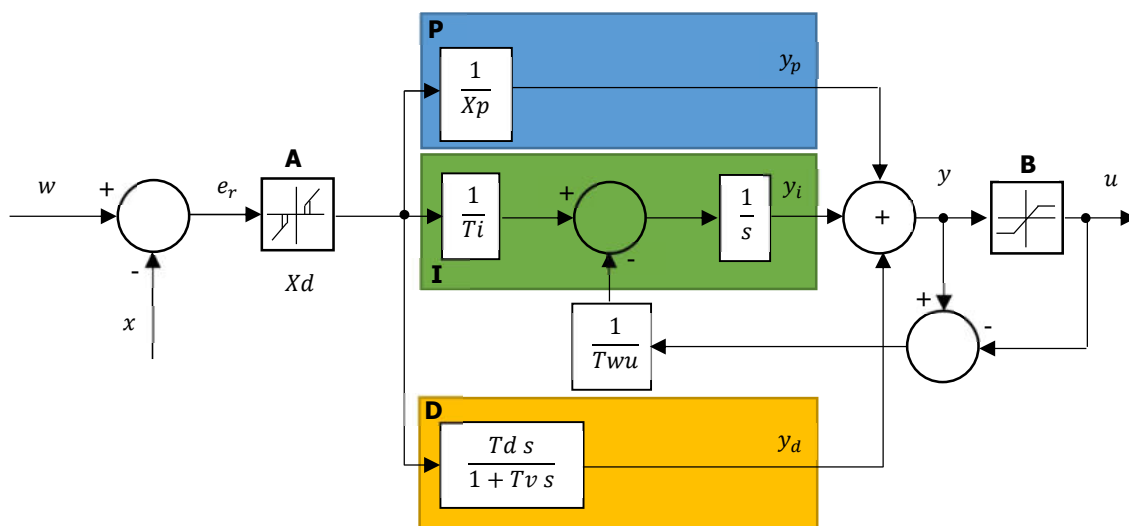

- | | | | |
|-----|-------------------------------|----|---------------------------------|
| A | Dead band | w | Setpoint of regulation |
| B | Limitation of the output | x | Measurement value |
| P | Calculation of the proportion | e | Regulation error |
| I | Calculation of the integral | y | Need regulation |
| D | Calculation of the derivate | u | Dose control |
| Xp | Reciprocal proportional value | Ti | Integral time |
| Td | Time of the derivative | Xd | Dead band value around setpoint |
| Tv | Filter constant | | |
| Twu | Anti-saturation | | |

The difference between the setpoint **w** and the measurement **x** corresponds to the regulation error, which is filter by a dead band.

Dead band **A** eliminates small regulation errors. The filtered control error is transmitted to the P.I.D calculator which consists of three components. Proportional **P**, Integral **I** and Derivative **D**. The integral (in green) also has an anti-saturation system for limiting the action of the integral.

The sum of the three components gives a need for regulation **Y** which is limited according to the actuators you use, **B** (-100% to 0% or 0% to +100% or -100% to +100%).

- **E01 pH PI1**
 - Parameter identification, includes information on parameter number (**E01**), type (**pH**) and associated main sensor input (**PI1**)
- **Mode P.I.D**
 - Dosage mode selection, on this selection button we find the selected mode information (**P.I.D**). Press to modify.
- **Setpoint 7,20 pH**
 - Enter the setpoint value. Here the value is (**7,20**).
Press to open the numeric keyboard and enter the desired value.
- **Dead band 0,01 pH**
 - Enter the dead band value. Here the current value is (**0,01**).
Press to open the numeric keyboard and enter the desired value.
- **Integral OFF**
 - Enter the integral value. Here it's disabled, current value is (**OFF**).
Press to open the numeric keyboard and enter the desired value.
- **Derivate OFF**
 - Enter the derivate value. Here it's disabled, current value is (**OFF**).
Press to open the numeric keyboard and enter the desired value.



When the integral and the derivate are OFF the dosing mode is **PROPORTIONAL**.

When only the derivate is on OFF the dosing mode is **PROPORTIONAL INTEGRAL**.

If all values are entered the dosing mode is **PROPORTIONAL INTEGRAL DERIVATE**.

- **Basic load OFF % - Maximum time OFF min – Activation threshold 90 %**
 - See Hysteresis dosing mode



Save:

- When a change is made, the "SAVE" button appears (floppy icon), you must save your configuration by pressing it.

3) Menu « Settings » - « ALARMS » [0321]



« ALARMS » menu will allow you to adjust the alarms operation mode of the parameters.

Press to open following screen.

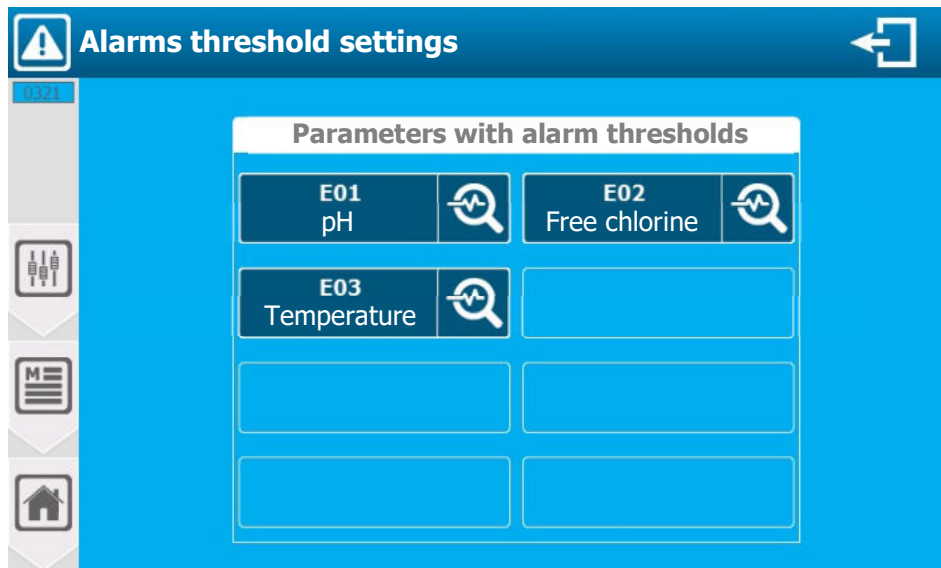

The screen presents the settings that are configured. You can by pressing an active parameter configure alarms.

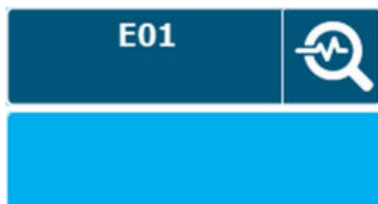

Parameter type with dose output affected.
Press to create or edit dosage configuration.

Parameter isn't configured.



E01 to E08 Parameters identification.

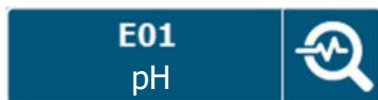

Press to open following screen.

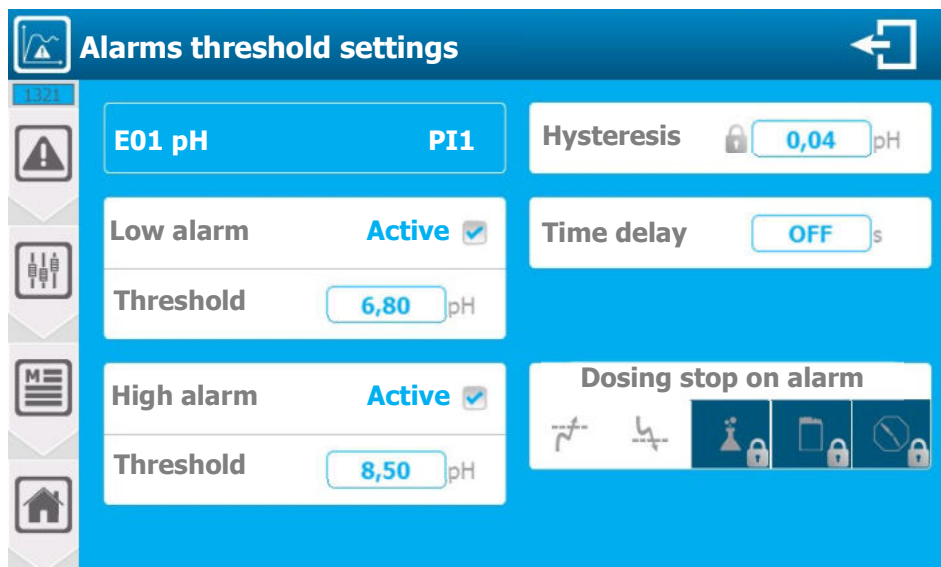

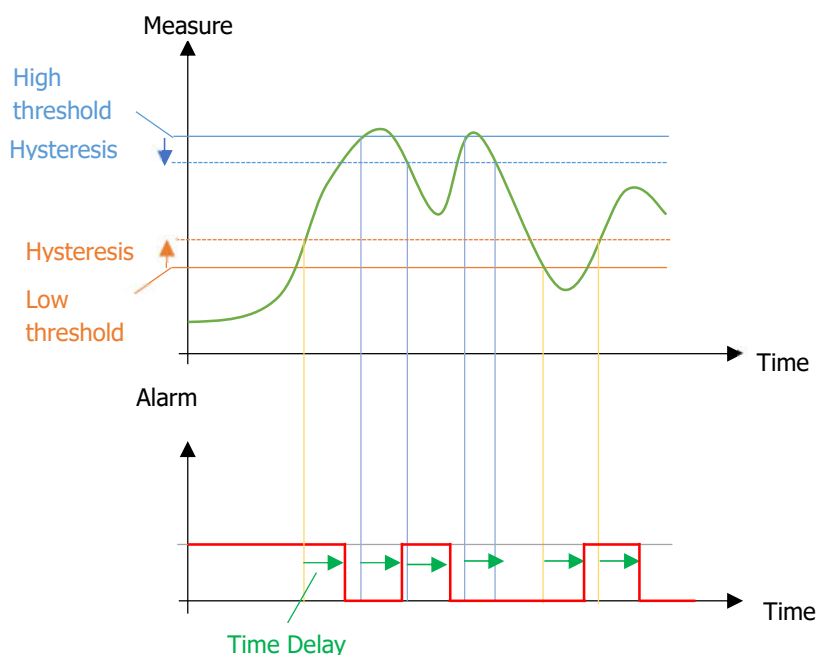

- **E01 pH PI1**
 - Parameter identification, includes information on parameter number (**E01**), type (**pH**) and associated main sensor input (**PI1**)
- **Low alarm Active**
 - You must check this option to enable low alarm threshold management. Here the management is (**Active**).
- **Threshold 6,80 pH**
 - Enter the low alarm threshold value. Here the current value is (**6,80**). Press to open the numeric keyboard and enter the desired value.
- **High alarm Active**
 - You must check this option to enable high alarm threshold management. Here the management is (**Active**).
- **Threshold 8,50 pH**
 - Enter the high alarm threshold value. Here the current value is (**8,50**). Press to open the numeric keyboard and enter the desired value.
- **Hystérésis 0,04 pH**
 - Enter the hysteresis value of the alarm threshold. Here the current value is (**0,04**). Press to open the numeric keyboard and enter the desired value.



This setting is only available if the unlock option is enabled in the setting options.



This value sets a value delta in which the alarm remains active. This allow for stable alarms when the measurement value oscillates around the value of an alarm threshold.

- **Time delay OFF**
 - Enter the value of the time delay to take into account an alarm. Here the time delay is disabled, current value is (**OFF**). Press to open the numeric keyboard and enter the desired value.
- **Dosing stop on alarm**
 - Selection of alarm(s) to be taken into account, for stopping the dosage. Multiple selection type, press the alarms you want to associate.



This setting is only available if the unlock option is enabled in the setting options.

- Save:**
- When a change is made, the "SAVE" button appears (floppy icon), you must save your configuration by pressing it.

4) Menu « Settings » - « CALIBRATION » [0421]



« CALIBRATION » menu allows you to calibrate the measurement sensors.

Press to open following screen.

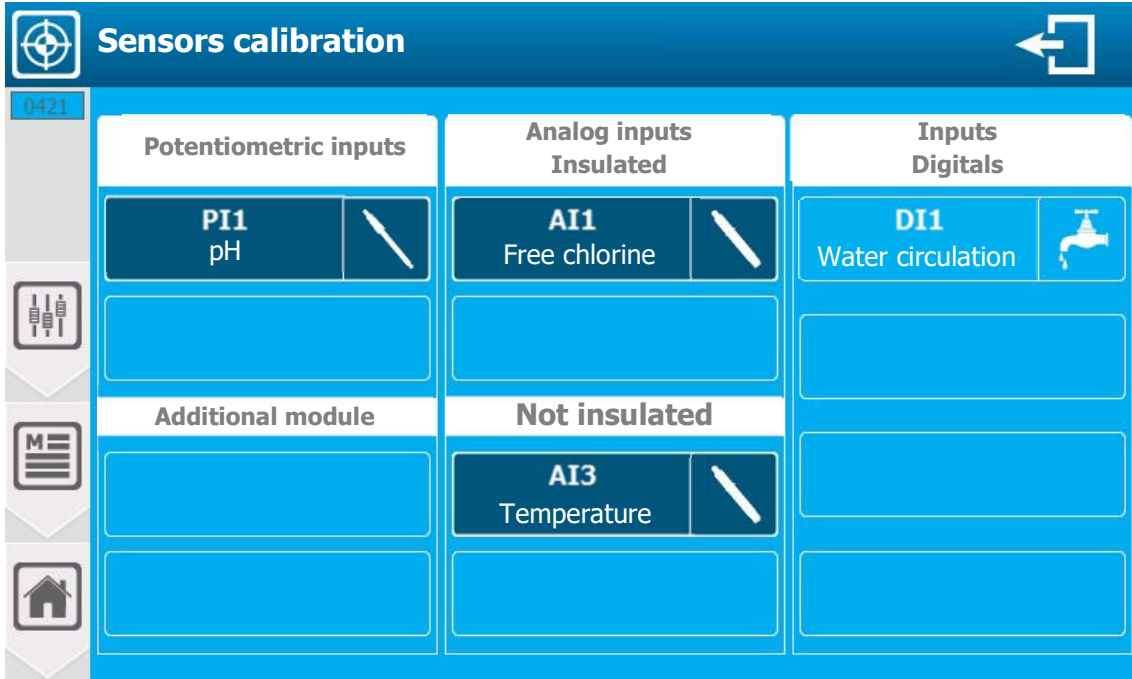

The screen shows the sensors that are configured. Press an active sensor to open the calibration screen.

PI1		Sensor type with possible calibration. Press to open calibration screen.
DI1		Sensor type cannot be calibrated.
		Sensor isn't configured

a) Calibration screen presentation [1421]

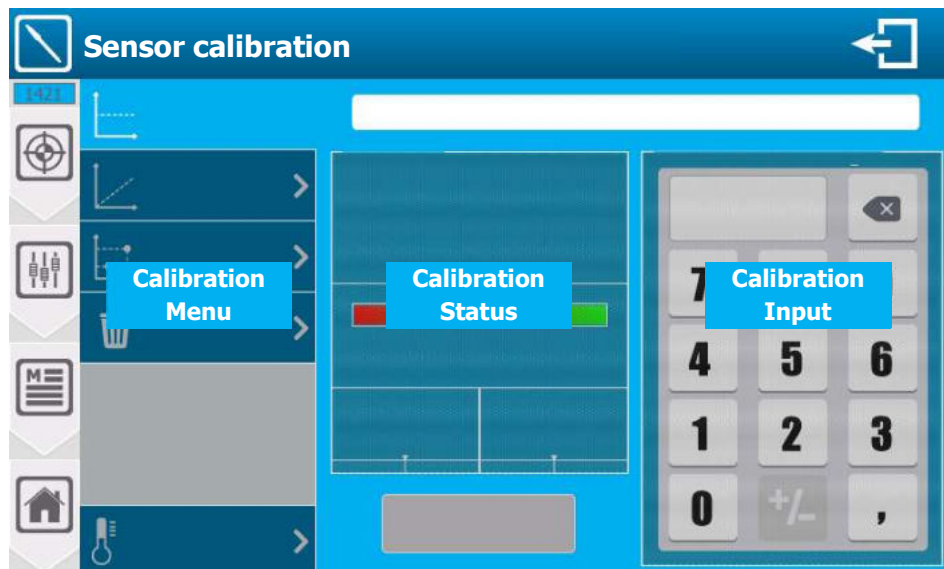

b) Calibration menu

- Depending on the type of sensor to calibrate the menu doesn't have the same options.
- 2-point calibration is only available on pH sensor.
- Temperature compensation is only available on pH sensor.
- ORP sensors don't have slope calibration.
- Flowrate sensors don't have offset calibration.

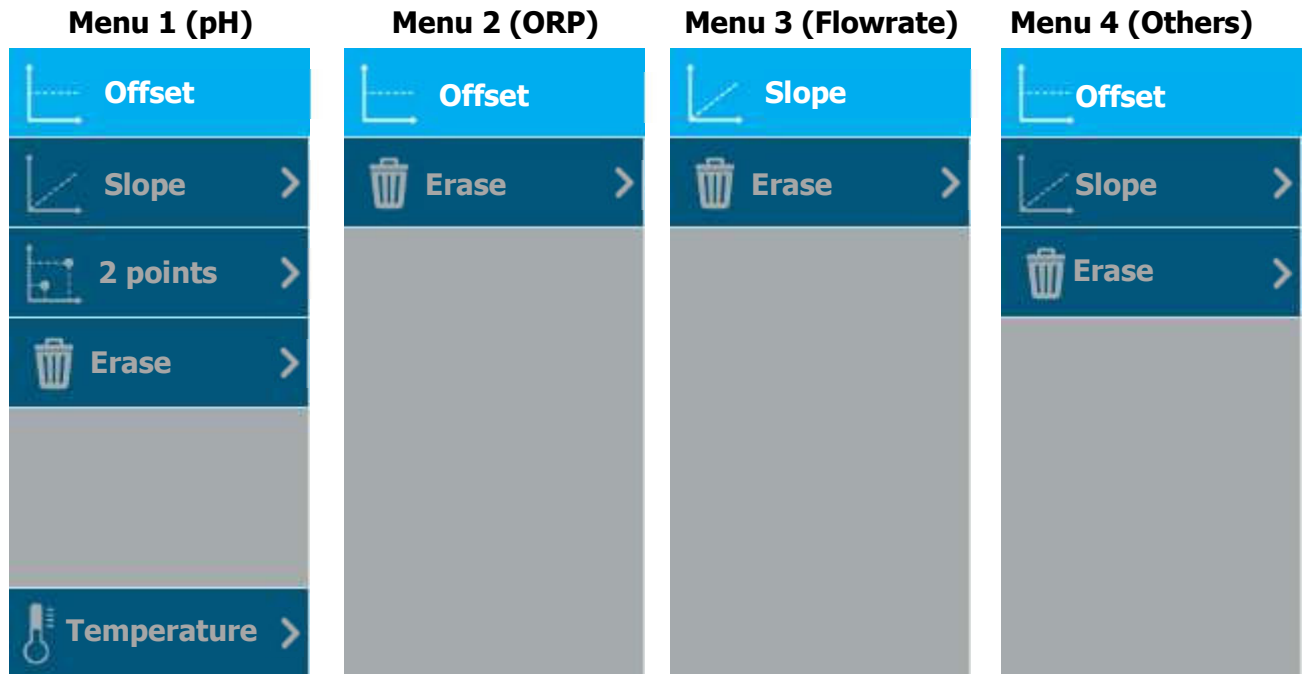

c) Calibration status

- Depending on the stability and measurement value of the sensor, the status screen may change as below. It's necessary that the measurement value is stable and in a "correct" range to validate the calibration.

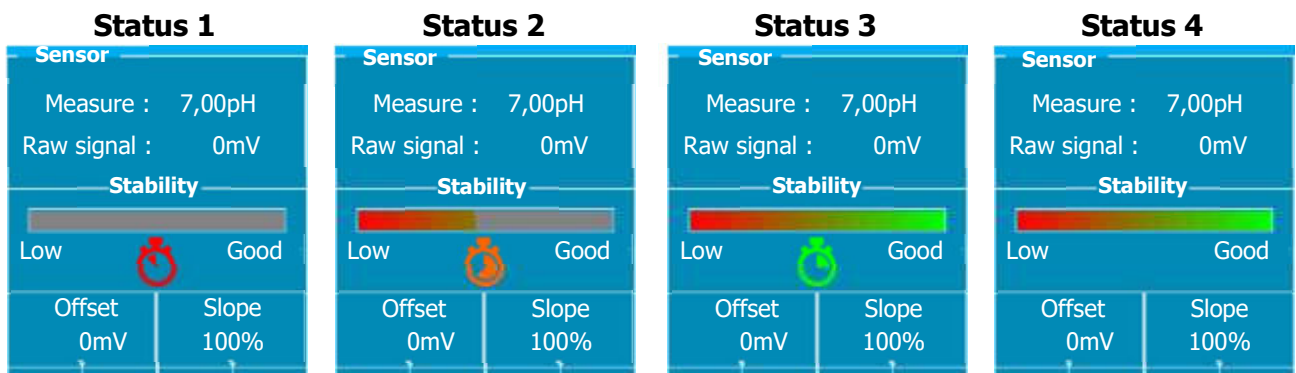

- Status 1:
 - ⇒ Very unstable sensor (Measurement value changes rapidly)
 - ⇒ Sensor disconnected or Out of order (Measurement and Raw signal displays « - - - »)
- Status 2:
 - ⇒ Sensor being stabilized
- Status 3:
 - ⇒ Stabilized sensor
- Status 4:
 - ⇒ Authorized calibration

- Offset (Example pH):

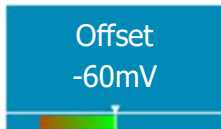

- ⇒ Displays sensor offset calibration status
- ⇒ The more the bar graph tend toward red, the more we reach the limit of calibration. This information can be a sign of ageing of the sensor.
- ⇒ Offset is expressed in the unit of the physical input of the sensor. The min. and max. values are different depending on the sensors.

- Slope (Example pH):

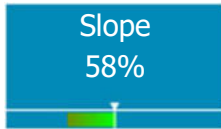

- ⇒ Displays sensor slope calibration status
- ⇒ The more the bar graph tend toward red, the more we reach the limit of calibration. This information can be a sign of ageing of the sensor.
- ⇒ Slope is expressed as a percentage and can vary from 0% to 200%. 100% represents a slope without calibration.

d) Calibration input

- Keyboard that allows you to enter the "real" value you want to use for calibration.
- In the particular case of pH calibration with one/some buffer(s) solution(s), the value of the solution must be entered. Same applies for ORP.
- This part is also used for pH temperature compensation value in the particular case of pH if necessary.
- Keyboard use is the same as the "standard" numeric keypad.
- If an incorrect value is entered or out of scale, the value entered is displayed in red and the "Save" button becomes inactive.

Correct value



Incorrect value



e) Calibration validation messages

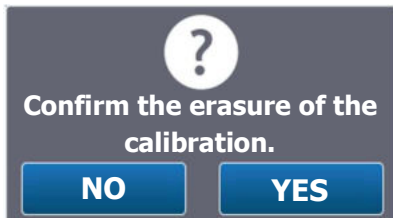

Confirmation message:

- ⇒ When erasing a confirmation message is displayed before performing the procedure.

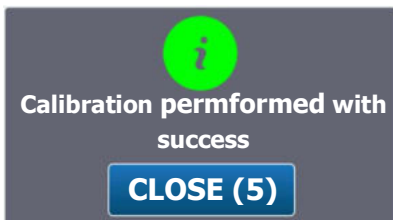

Valid calibration messages:

- ⇒ Calibration cleared successfully.
- Or
- ⇒ Calibration performed successfully.



Incorrect calibration messages:

- ⇒ Incorrect offset value.
(Offset overflow allowed for sensor)
- Or
- ⇒ Incorrect slope value.
(Exceeding the allowed slope for the sensor)
- Or
- ⇒ Two points too close.
(2 points of pH calibration are not far enough)

f) Offset calibration

- **Wait for the sensor stabilization**
- **Enter the calibration value**
- **Press « SAVE »**

g) Slope calibration

- **Wait for the sensor stabilization**
- **Enter the calibration value**
- **Press « SAVE »**

h) Erasing the calibration

- **Press « Erase »**



A confirmation request will be displayed.

There is no « analysis » of measurement value, erasure can be performed even if the sensor is unstable or absent.

i) 2 points calibration (pH)

2 points calibration is a « assisted » offset and slope calibration, and only available on pH sensors. It's made using buffer solutions.

The procedure is carried out in two steps with two solutions.

- Step 1:

- **Put the pH sensor in solution 1 (Ex: pH7)**
- **Wait for the sensor stabilization**
- **The controller automatically enters the 7.00 value in calibration value, if your solution has a different value, enter the value of your solution.**
- **Press « SAVE »**

- Step 2 :

- **Put the pH sensor in solution 2 (Ex : pH4)**
- **Wait for the sensor stabilization**
- **The controller automatically enters the 4.00 value in calibration value, if your solution has a different value, enter the value of your solution.**
- **Press « SAVE »**

j) Temperature compensation (pH)

Temperature has a more or less influence on the pH, depending on the pH deviation from 7 and the temperature deviation from 25°C.

Example :

If you calibrate the pH with a pH4 solution at a temperature of 10°C, the difference between the uncompensated and compensated pH value is approximately 0.2pH.

This discrepancy can be corrected with the temperature compensation function..

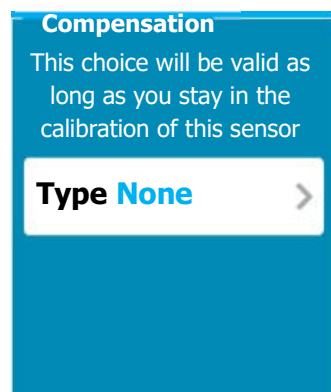

➤ **Type None**

- Compensation mode selection, this selection button displays the selected mode information (**None**). Press to change it.

Compensation
 This choice will be valid as long as you stay in the calibration of this sensor

Type Manual >

Unit °C >

* Enter the value on the keypad on the right

- > **Type Manual**
 - Compensation mode selection, this selection button displays the selected mode information (**Manuel**). Press to change it.
- > **Unit °C**
 - Temperature unit selection that you will enter in the numeric keyboard part, on this selection button you will find the selected unit information (**°C**). Press to change it.

Compensation
 This choice will be valid as long as you stay in the calibration of this sensor

Type Sensor AI3 >

- > **Type Sensor AI3**
 - Compensation mode selection, this selection button displays the selected mode information (**Sensor**) and the corresponding entry (**AI3**). Press to change it.



When temperature compensation is enabled, an icon appears next to the measurement value in the calibration status area.

Sensor

Measure : 7,00pH 

Raw signal : 0mV

Programmed and active compensation

Sensor

Measure : 7,00pH 

Raw signal : 0mV

Programmed compensation with a sensor but the sensor measurement value isn't correct.
 The calibration isn't blocked, but the compensation will be done with T = 25°C.

5) Menu « Settings » - « FLOWRATE » [0521]

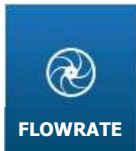

« FLOWRATE » menu will allow you to adjust the low flow threshold as well as the levels for the dosage adjustment.

Press to open the following screen.



This menu is only accessible if you have set up a flowrate sensor in the "INSTALLATION" part. Otherwise it remains grey.

a) « Standard » version

Flowrates are only parameters. The control and low threshold setting are applied at the parameter level and will be the same for all parameters that are controlled by this flowrate.

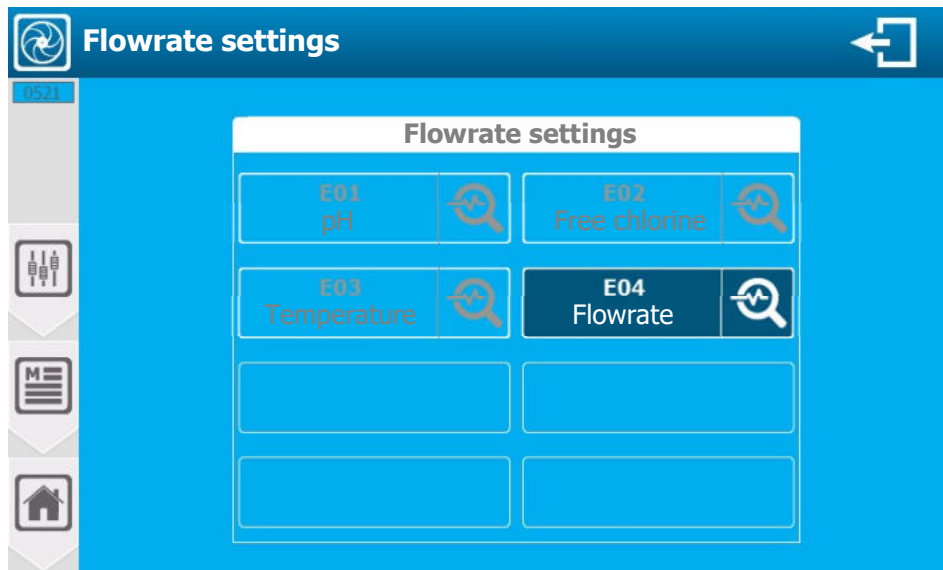

The screen shows the flowrate type parameters that are configured. By pressing, an active parameter, you can configure the flowrates.

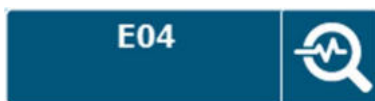

Flowrate parameter type.
Press to create or edit the flowrate configuration.



Parameter type isn't a flowrate.



Parameter isn't configured



E01 to E08 Parameters identification.

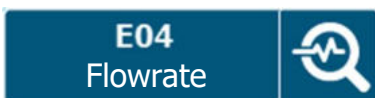

Press to open following screen.

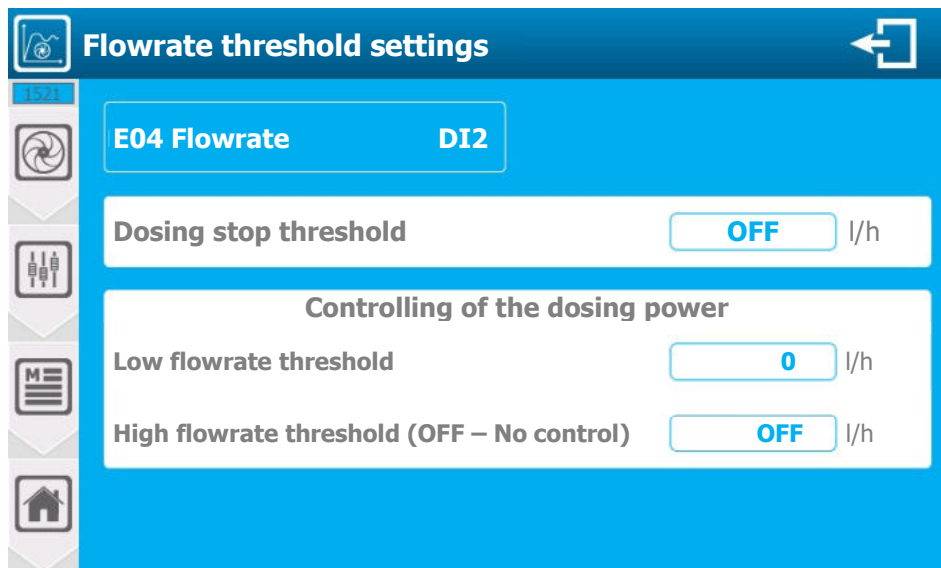

- **E04 Flowrate DI2**
 - Parameter identification, we find the parameter number identification (**E04**), type (**Flowrate**) and associated sensor input (**DI2**).
- **Dosing stop threshold OFF**
 - Enter the low flowrate level which the dosage of the parameter conditioned by this flowrate will be cut. Here the threshold is disabled, current value (**OFF**), dosages will not be cut by the flowrate. Press to open the numeric keyboard and enter the desired value.
- **Low flowrate threshold 0 l/h**
 - Enter low flowrate level for dosage control. Here the current value is (**0**). Press to open the numeric keyboard and enter the desired value.
- **High flowrate threshold (OFF – No control) OFF**
 - Enter high flowrate level for dosage control. Here the control function is disabled, current value (**OFF**). Press to open the numeric keyboard and enter the desired value.

Save:

- When a change is made, the "SAVE" button appears (floppy icon), you must save your configuration by pressing it.

b) « Sensors & parameters » version

This version is only available if the installation option "Condition the flow rates only to the parameter" is disabled.

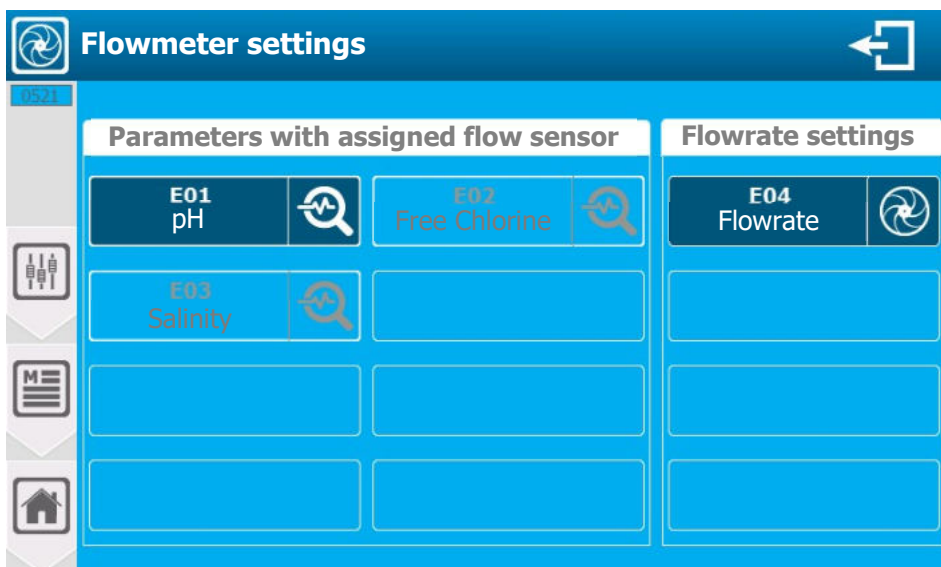

In the example above the pH parameter has a flowrate sensor affected in packaging. The threshold setting of the flowrate control will be specific to the pH parameter.

The screen shows the parameters & "flowrate" parameters that are configured. You can, by pressing and active parameter, configure the flowrate.

➤ See previous page for flowrate threshold setting

6) Menu « Settings » - « TANK LEVEL 4...20mA » [0621]



« TANK LEVEL 4...20mA » menu will allow you to adjust the low threshold of the tank volume that enslave dosages.

Press to open following screen.



This menu is only accessible if you have set up a volume sensor in the "INSTALLATION" part. Otherwise it remains grey.

a) « Standard » version

Volumes are only parameters. The control and low threshold setting are applied at the parameter level and will be the same for all parameters that are controlled by this volume.

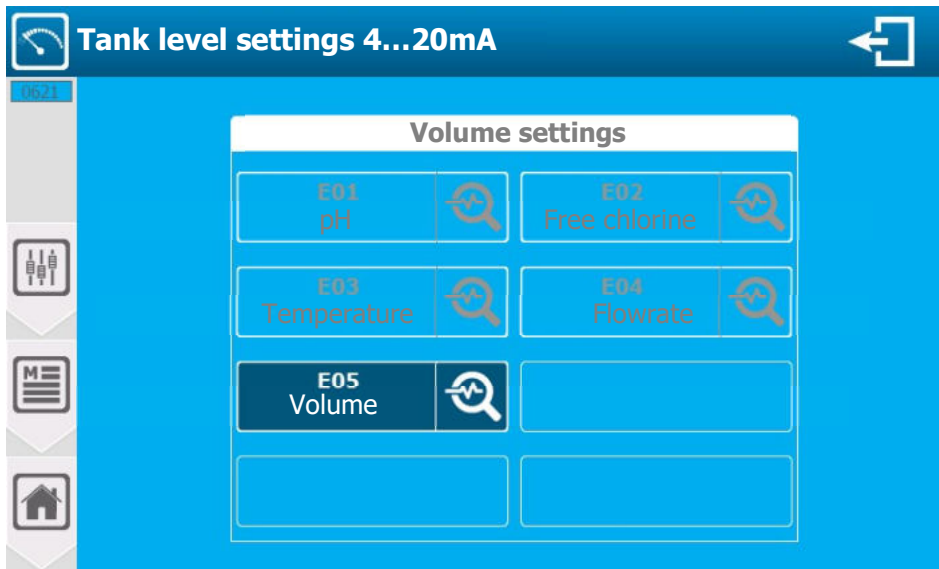

The screen shows the volume type parameters that are configured. By pressing, an active parameter, you can configure the bottom threshold of the tank.



Volume type parameter.
Press to create or edit the flowrate configuration.



Parameter type isn't volume



Parameter isn't configured.



E01 to E08 Parameters identification.

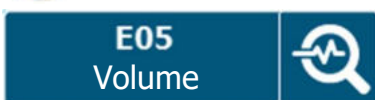

Press to open following screen.

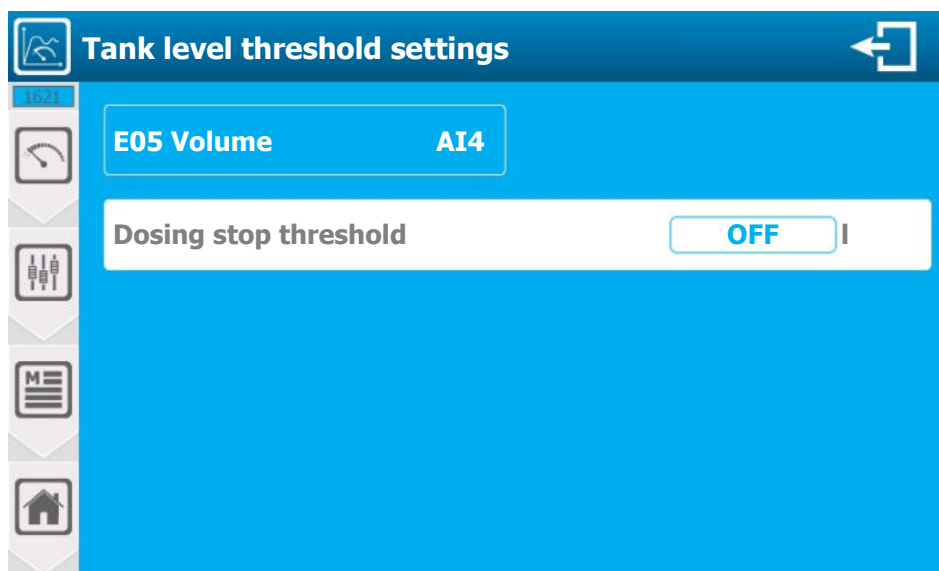

- **E05 Volume AI4**
 - Parameter identification, we find the parameter number identification (**E05**) ; type (**Volume**) and associated sensor input (**AI4**).
- **Dosing stop threshold OFF**
 - Enter the low tank level which the dosage of the parameter conditioned by this tank level will be cut. Here the threshold is disabled, current value (**OFF**), dosages will not be cut by the tank level. Press to open the numeric keyboard and enter the desired value.

Save:



- When a change is made, the "SAVE" button appears (floppy icon), you must save your configuration by pressing it.

b) « Sensors & parameters » version

This version is only available if the installation option "Condition the tank bottom volumes only to the parameter" is disabled.

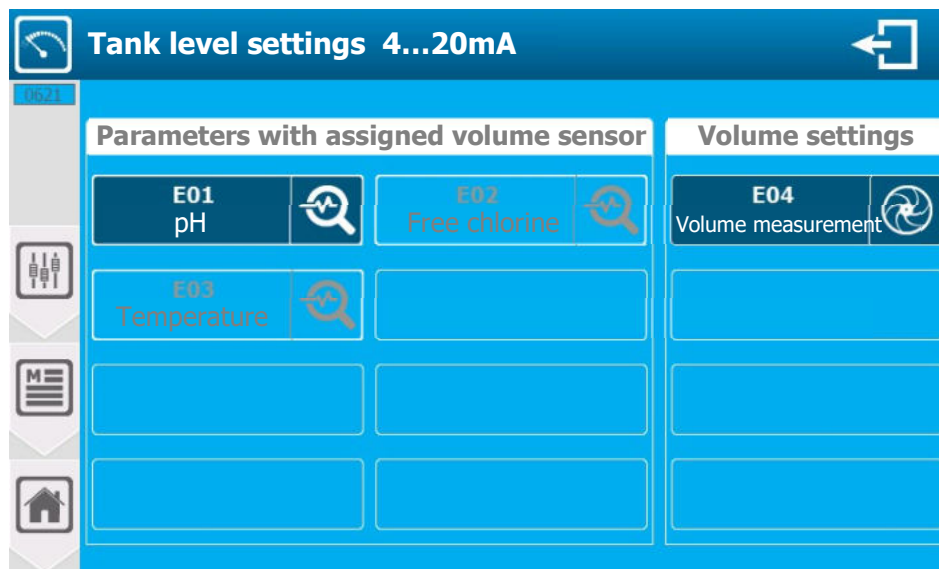

In the example above the pH parameter has a volume sensor affected in packaging. The threshold setting of the volume control will be specific to the pH parameter.

The screen shows the parameters & "volume" parameters that are configured. You can, by pressing and active parameter, configure the volumes.

- **See previous page for volume threshold setting**

7) Menu « Settings » - « TRANSFERs 4...20mA » [0721]

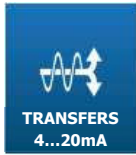

« TRANSFERs 4...20mA » menu will allow you to adjust the low and high threshold of the transfers 4...20mA.

Press to open following screen.



This menu is only accessible if you have set up a 4...20mA sensor in the "INSTALLATION" part. Otherwise it remains grey.

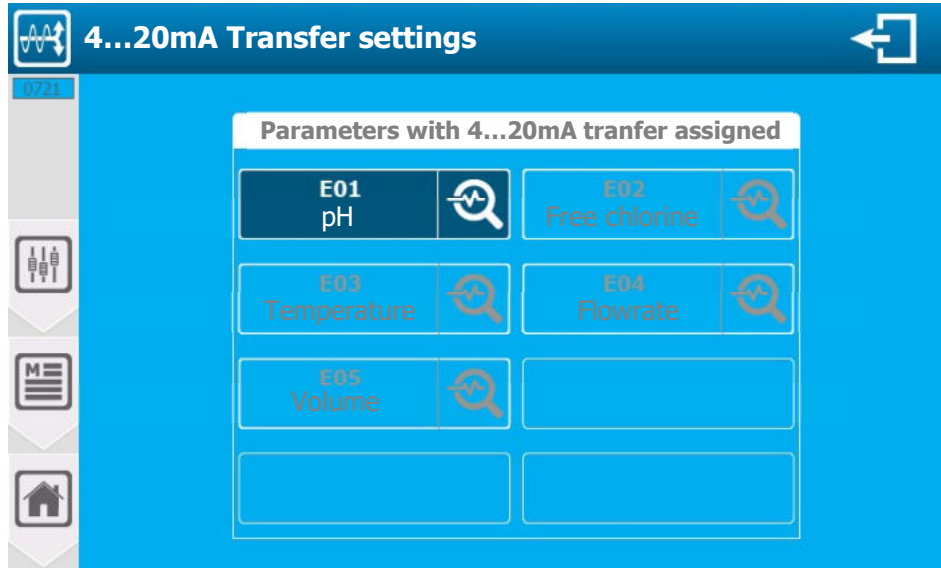

The screen shows the parameters to which a 4...20mA output is assigned in transfer mode. You can, by pressing an active parameter, configure the transfer thresholds.

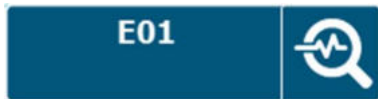

Parameter type with assigned transfer.
Press to create or edit the thresholds transfer.



Parameter type has no transfer affected.



Parameter isn't configured.



E01 to E08 Parameters identification.



Press to open following screen.

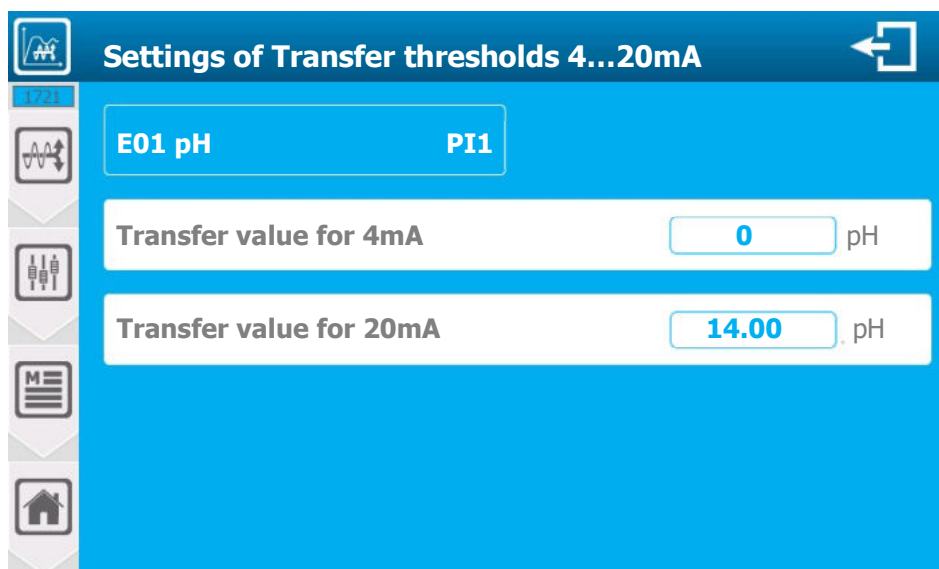

- **E01 pH PI1**
 - Parameter identification, we find the parameter number identification (**E01**) ; type (**pH**) and associated sensor input (**PI1**).
- **Transfer value for 4mA 0** pH
 - Enter the corresponding pH value for 4mA at transfer output. Here the value is (**0**). Press to open the numeric keyboard and enter the desired value.
- **Valeur de transfert pour 20mA 14** pH
 - Enter the corresponding pH value for 20mA at transfer output. Here the value is (**14**). Press to open the numeric keyboard and enter the desired value.

**Save:**

- When a change is made, the "SAVE" button appears (floppy icon), you must save your configuration by pressing it.

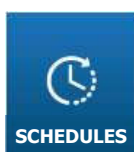
8) Menu « Settings » - « SCHEDULES »

Not available

VII. Programming screen « USER » [0011]

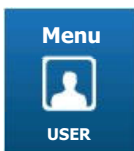

« USER » menu will allow you to access the settings of the graphical interface.

Press to open the following screen.

Menu « UTILISATEUR »

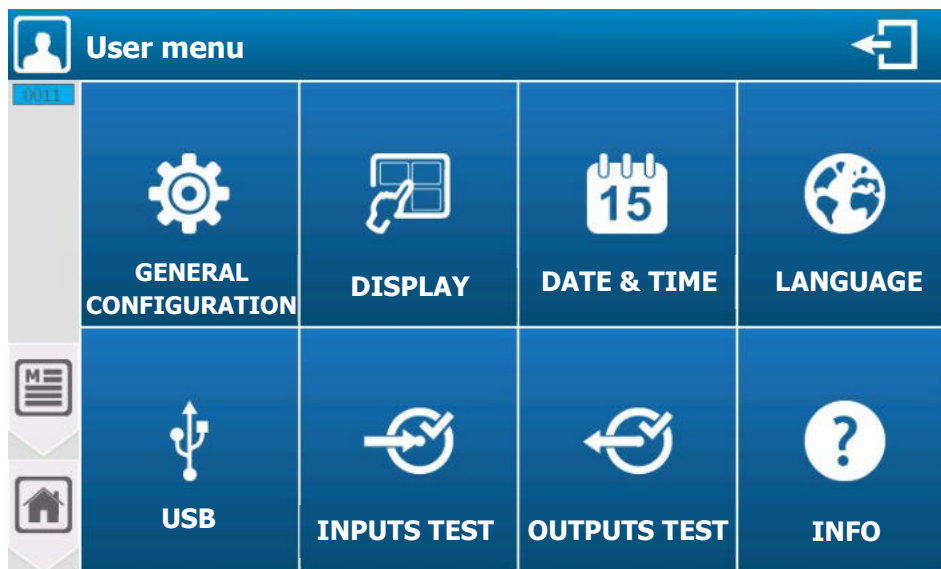

1) Menu « User » - « GENERAL CONFIGURATION » [0111]



« GENERAL CONFIGURATION » menu will allow you to access the audio and visual configuration of the graphical interface.

Press to open following screen.

a) Menu « General configuration » - « SCREEN » [0111]

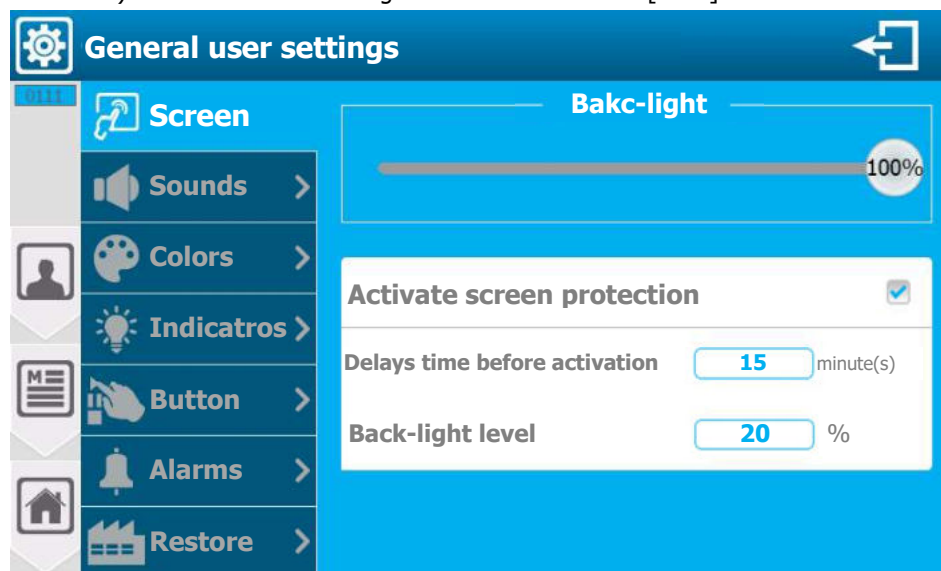

➤ **Back-light**

- Use cursor to adjust the back-light level as desired.

➤ **Activate screen protection**

- You must check this option to enable screen protection management. Without pressing the screen during the time entered, the back-light level will decrease to the set value. Here the management is **(Active)**.

- **Delays time before activation 15 minute(s)**
 - Enter the delay value before screen protection activation. Here the delay is (15) minutes. Press to open the numeric keyboard and enter the desired value.
- **Back-light level**
 - Enter back-light value during screen protection. Here the value is (20) %. Press to open the numeric keyboard and enter the desired value.

b) Menu « General configuration » - « SOUNDS » [0111]

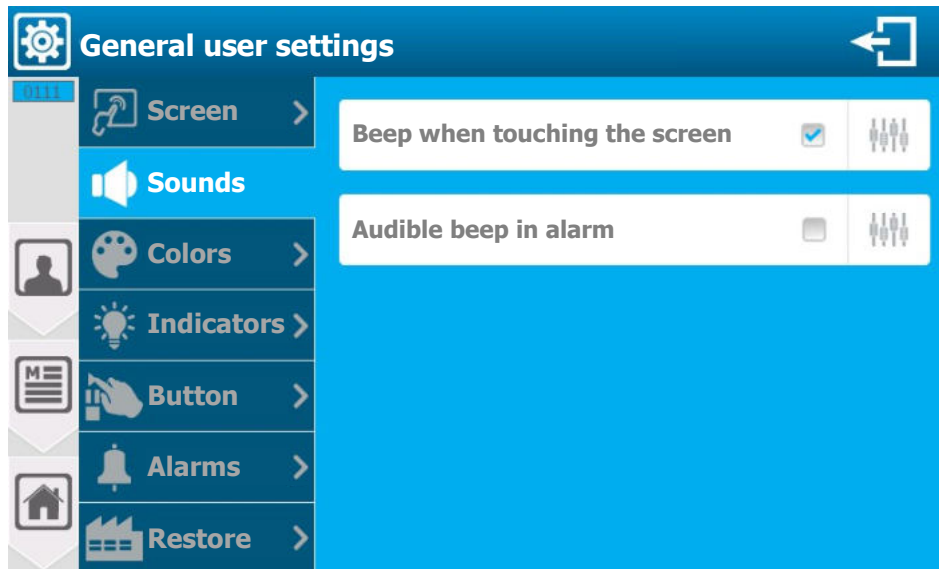

- **Beep when touching the screen**
 - You must check this option to enable beep management et each valid tap on the screen. Here the option is (Active).
- **Audible beep in alarm**
 - You must check this option to enable the management of a beep every second in case of a "general" alarm. Here the option is (Disabled).
- **Sound adjustment**
 - You can change the sound rendering of each beep. By pressing the beep setting icon, you can change the beep frequency and its duration.

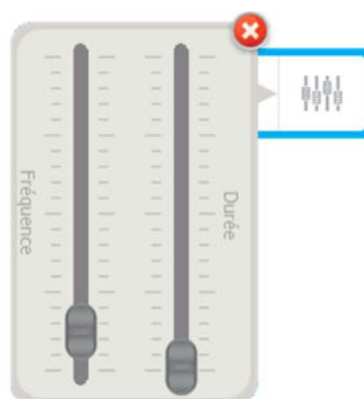

Move the cursors by remaining pressed to change the frequency and duration values.

c) Menu « General configuration » - « COLORS » [0111]

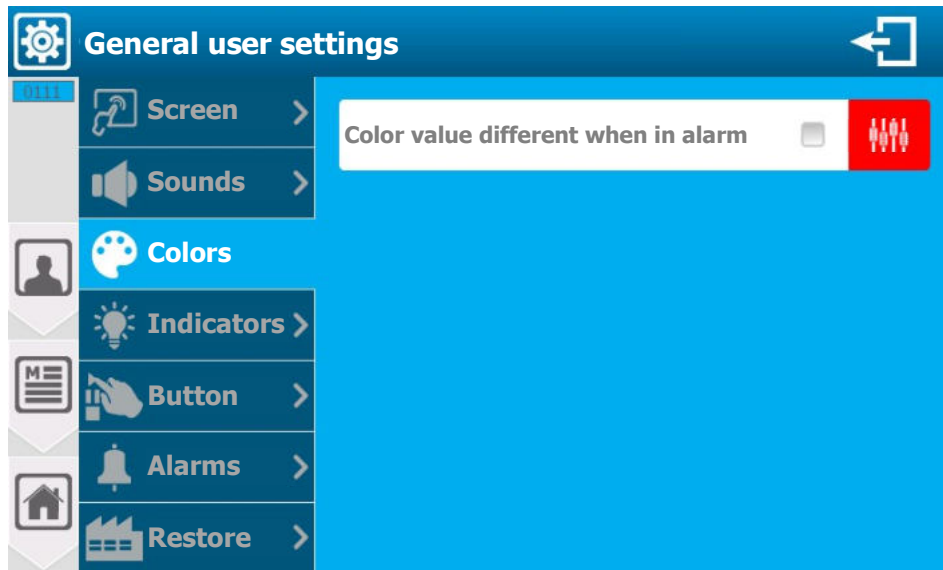

- **Color value different when in alarm**
 - Measurement value of each parameter displayed on the main screen thumbnails may be displayed in a different color if the parameter is on alarm. To do this you must check this option. Here the option is (**Disabled**).
- **Color adjustment**
 - You can change the color by varying its components (RED – GREEN – BLUE). By pressing the color adjustment icon, you can change the setting according to your wishes.

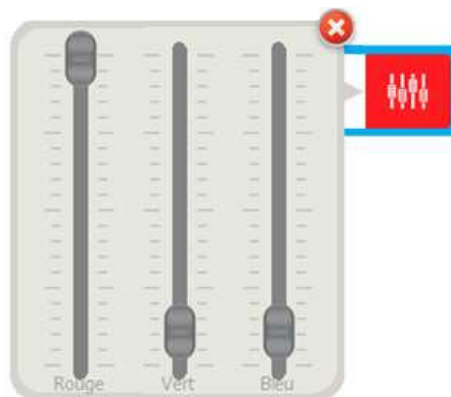

Move the cursors by remaining pressed to change the basics Red / Green / Blue.

d) Menu « General configuration » - « INDICATORS » [0111]

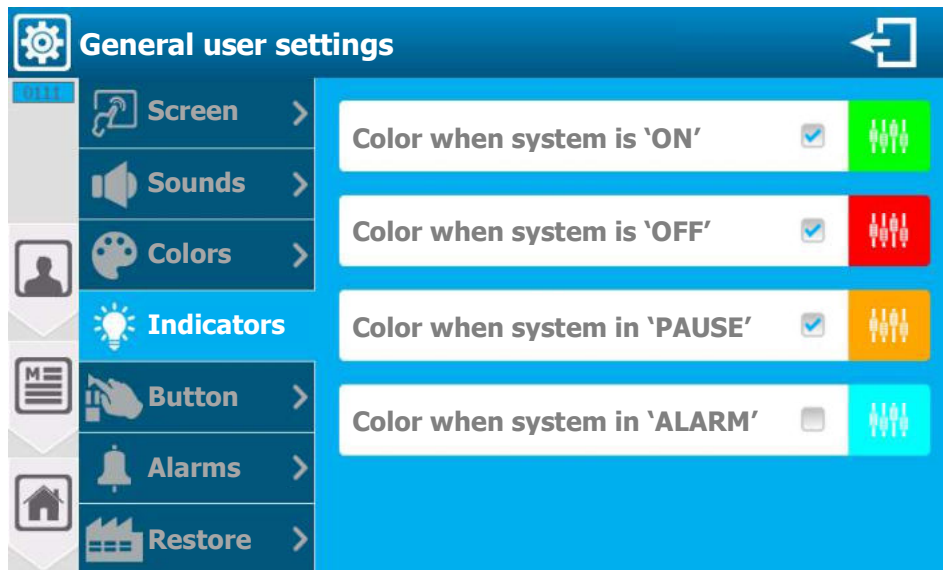

- **Color when system is "ON"**
 - To activate the LED when the regulator is in use you must check this option. Here the option is (**Activated**).
- **Color when system is "OFF"**
 - To activate the LED when the regulator is stopped you must check this option. Here the option is (**Activated**).
- **Color when system in "PAUSE"**
 - To activate the LED when the regulator is in pause you must check this option. Here the option is (**Activated**).
- **Color when system in "ALARM"**
 - To activate the flashing light when the regulator is in alarm you must check this option. Here the option is (**Disabled**).
- **Color adjustment**
 - For each state, the color is customizable, to do it see « Color adjustment » previous page.

e) Menu « General configuration » - « BUTTON » [0111]

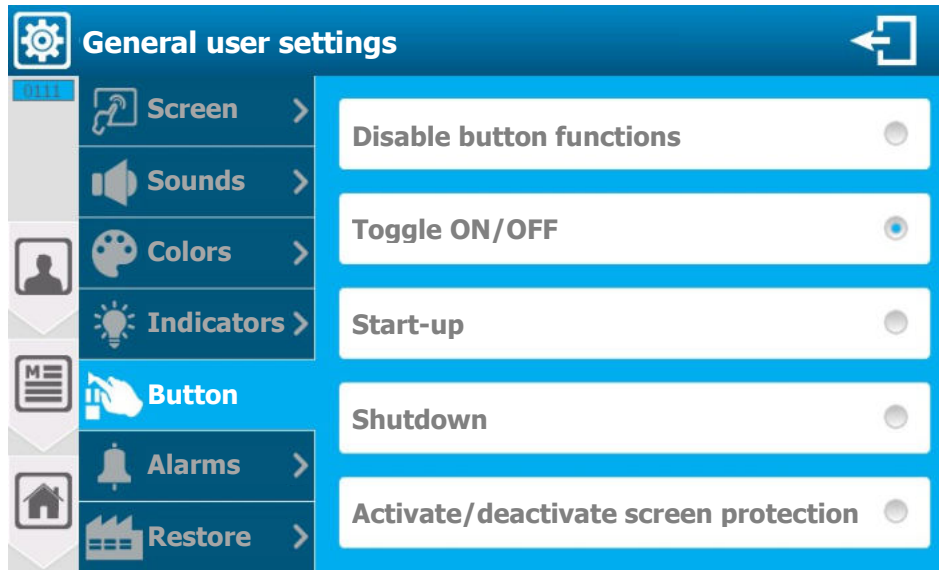

- **Disable button functions**
 - Disables external touch button functions
- **Toggle ON/OFF**
 - External touch button toggles the status of the regulator, On/Off at each pressure. This operation option is (**Selected**).
- **Strat-up**
 - External touch button only turns the regulator ON at each pressure. If it's already ON, no action.
- **Shutdown**
 - External touch button only turns the regulator OFF at each pressure. If it's already OFF, no action.
- **Activate / deactivate screen protection**
 - External touch button, toggles screen protection status On/Off at each pressure.

f) Menu « General configuration » - « ALARMS » [0111]

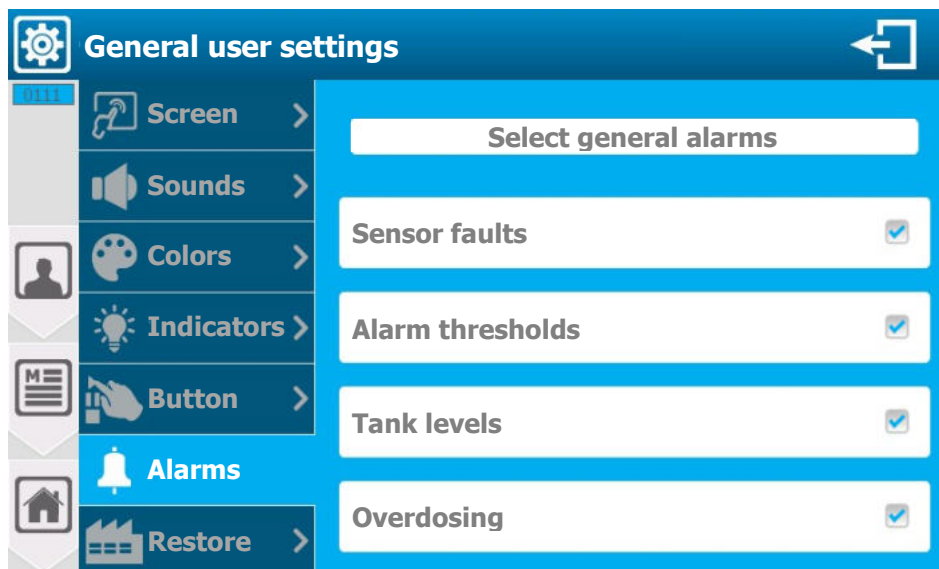

This alarm selection is used to activate the "Alarm beep" and to activate the alarm color of the LED. The system regroupes the alarms of all activate parameters before selecting the ones checked below.

- **Sensor faults**
 - Selects sensor faults (Unstable & Out of order sensors). Here this option is (**Active**).
- **Alarm thresholds**
 - Selects parameter alarm thresholds (Low Alarm & High Alarm). Here this option is (**Active**).
- **Tank level**
 - Selects tank level(s) parameters. Here this option is (**Active**).
- **Overdosing**
 - Selects paramters overdosage alarms. Here this option is (**Active**).

g) Menu « General configuration » - « RESTORE » [0111]

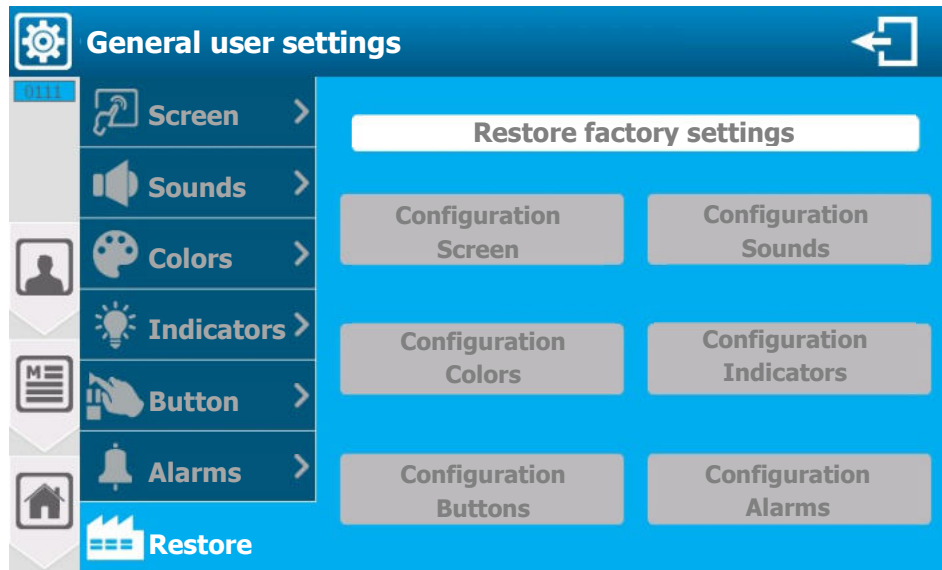

Buttons are only activated if factory configurations have been changed.

- **Configuration Screen**
 - Restore configuration options from Screen section to factory configuration.
- **Configuration Sounds**
 - Restore configuration options from Sounds section to factory configuration.
- **Configuration Colors**
 - Restore configuration options from Colors section to factory configuration.
- **Configuration Indicators**
 - Restore configuration options from Indicators section to factory configuration.
- **Configuration Buttons**
 - Restore configuration options from Buttons section to factory configuration.
- **Configuration Alarms**
 - Restore configuration options from Alarms section to factory configuration.

2) Menu « User » - « DISPLAY » [0211]



« DISPLAY » menu will allow you to access the settings display configuration.
Press to open following screen.

a) Automatic display

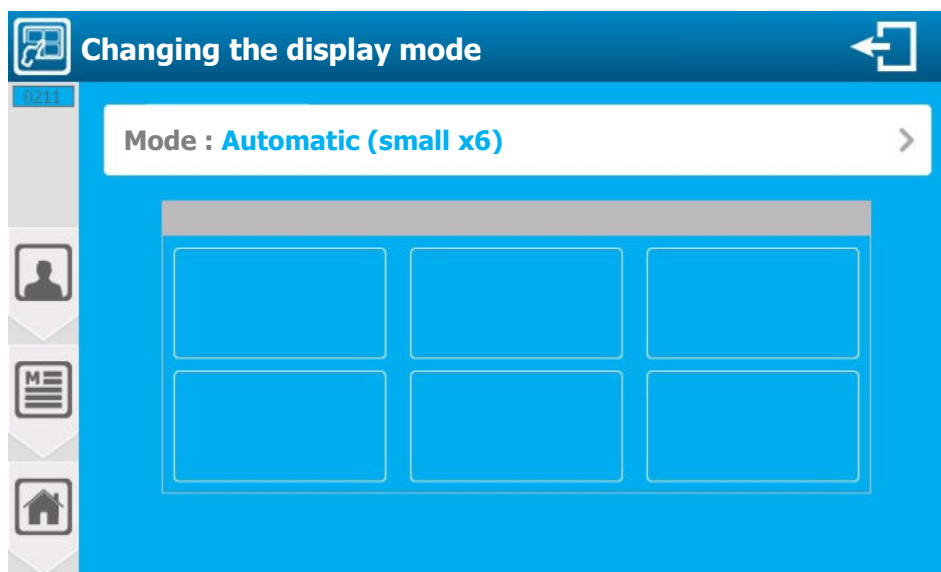

- **Mode: Automatic (small x6)**
 - Display mode selection, this button contains the information of the selected mode (**Automatic (small x6)**). Press to change it.



Regulator has two “auto” display modes, a “small x6” version that display six parameters per page, and a “large x3” version that display three parameters per page.

b) Manual display

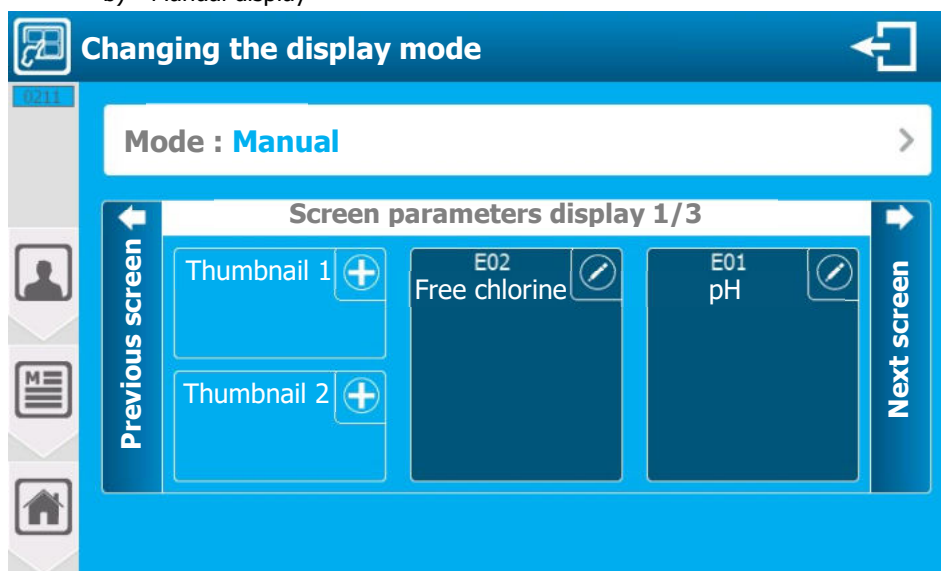

- **Mode: Manual**
 - Display mode selection, this button contains the information of the selected mode (**Manuel**). Press to change it.



Pres “Plus” to open the list of items available for display (parameter list & widgets)



Press “Edit” to open the menu below and edit a selected item.

Thumbnails menu "small size"

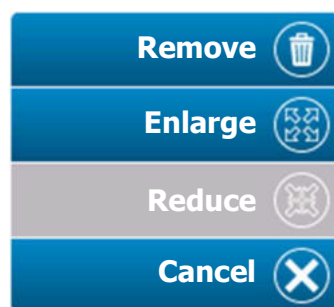

Thumbnails menu "big size"



- **Remove** ⇒ Delete the selected thumbnail
- **Enlarge** ⇒ Enlarge the selected thumbnail
- **Reduce** ⇒ Reduce the selected thumbnail
- **Cancel** ⇒ Close the menu

3) Menu « User » - « DATE & TIME » [0311]

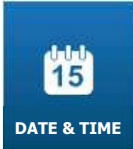

« DATE & TIME » menu will allow you to access the time settings configuration.

Press to open following screen.

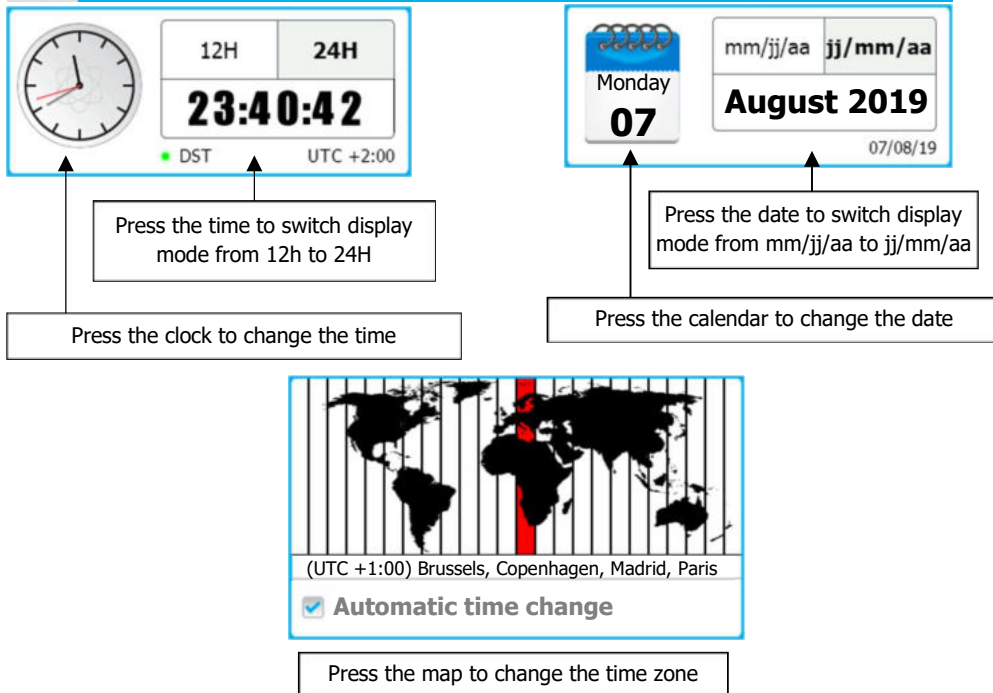
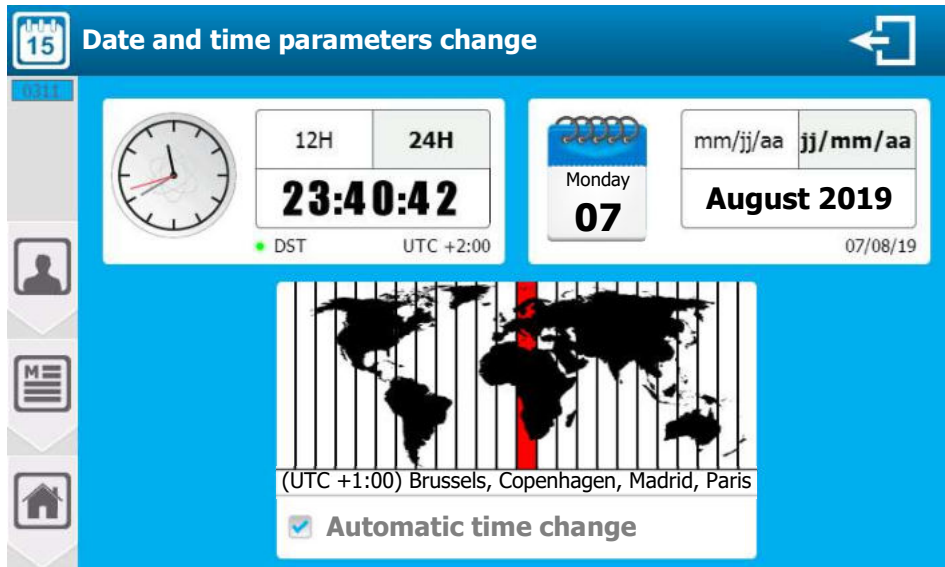

➤ **Automatic time change**

- If the selected time zone has Summer Time / Winter Time, your dispatcher will automatically change time. You can cancel this automatic time change by unchecking this box.

➤ **Automatic time change**

- Press the time zone map
- Scroll the list up or down, remaining pressed until the desired time zone is on the center part of the selection.
- Wait for automatically shutdown to account for new time zone.

(UTC +1:00)	Central Africa - West
(UTC +1:00)	Amsterdam, Berlin, Bern, Rome, Stockholm, Vienna
(UTC +1:00)	Belgrade, Bratislava, Budapest, Ljubljana, Prague
(UTC +1:00)	Brussels, Copenhagen, Madrid, Paris
(UTC +1:00)	Sarajevo, Skopje, Varsovie, Zagreb
(UTC +2:00)	Standard time UTC+02
(UTC +2:00)	Amman

4) Menu « User » - « LANGUAGE » [0411]



« LANGUAGE » menu will allow you to access the regulator language configuration.

Press to open following screen.



➤ **Language change**

- Press the desired language to select it.

5) Menu « User » - « USB » [0511]



« USB » menu will allow you to update firmware, export or import configuration.

Press to open following screen.

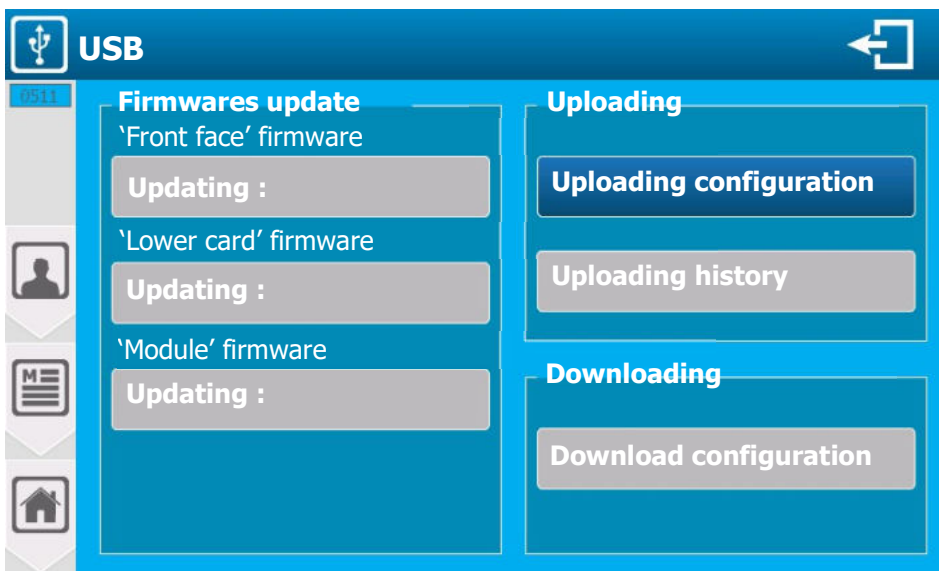

To access this menu, you need to insert a USB key.



The USB key must be formatted to FAT32.

- **Front face firmware**
 - When a firmware for the front face is available on the key, the corresponding update button activates. To perform the update, press the button.
- **Lower card firmware**
 - When a firmware for the lower card is available on the key, the corresponding update button activates. To perform the update, press the button.
- **Module firmware**
 - When a firmware for the module is available on the key, the corresponding update button activates. To perform the update, press the button.
- **Uploading configuration**
 - Export the complete machine configuration to a binary file on the USB key. To export press the button.
- **Uploading history**
 - Not available.
- **Download configuration**
 - When a configuration file is available on the key the button activates. Press the "Download configuration" button, it's then possible to import or not the "User" and "Communication" configuration in addition to the "Installation & Settings" part.

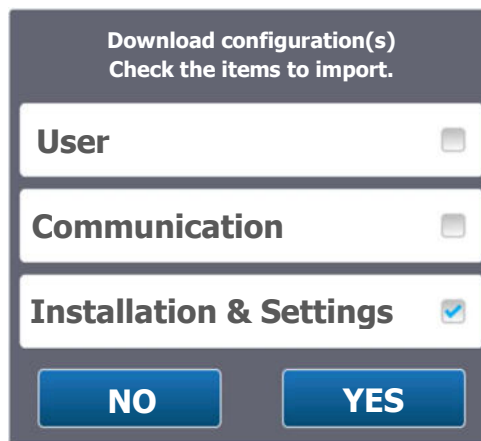

When you are on the main screen and you insert a USB key with an update, the window below will open automatically asking you if you want to open the programming screen.

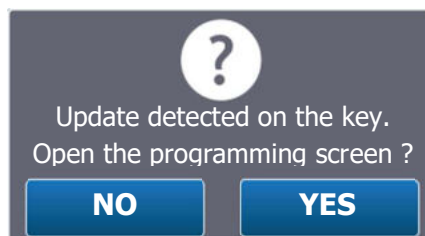

6) Menu « User » - « INPUTS TEST » [0611]



« INPUTS TEST » menu will allow you to view raw values and measurement values of all selected inputs.
Press to open following screen.

Inputs test

PI1	0 mV	7,00 pH	DI1 Open
	pH	- Offset : 0mV – Slope 100%	Water circulation
PI2	0 mV		DI2 Close
	Not used		R.C.I command
AI1	0,03 mA	--- mg/l	DI3 Close
	Free chlorine	- Offset : 0,0mA – Slope 100%	Other
AI2	--- mA		DI4 Close
	Not used		Bott. Level Tank
AI3	15,00 mA	29,4 °C	
	Temperature	- Offset : 0,0mA – Slope 100%	
AI4	--- mA		
	Not used		
MI1	823,21 Ω	1,2 mS/cm	F1
	Conductivity	- Offset : 0,0mA – Slope 100%	PO1 output fuse
MI2	120,18 Ω	52,7 °C	F2
	Temperature	- Offset : 0,0mA – Slope 100%	PO2 output fuse

➤ Analog sensor inputs

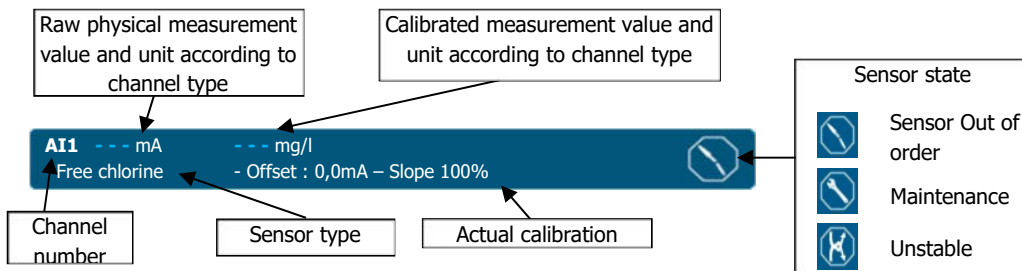

➤ Contact inputs

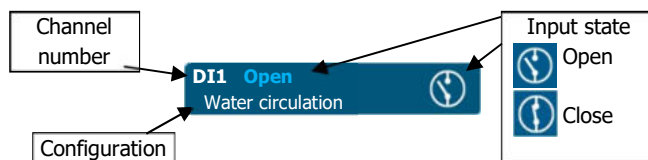

➤ Flowrate input

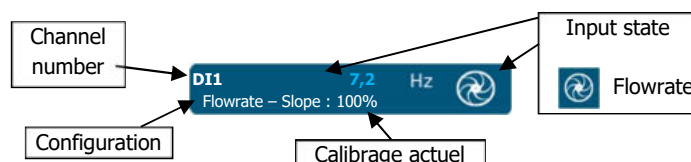

➤ Fuses state



➤ **Not used inputs**

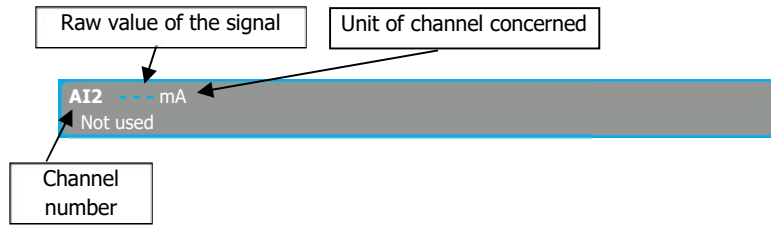

➤ **Inputs MIX**

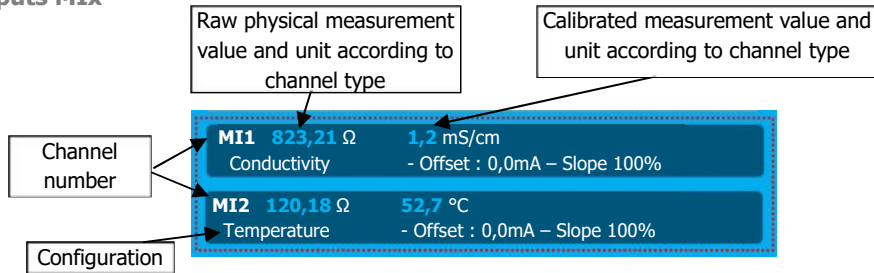

These two channels (**MI1** and **MI2**) appear only if the conductivity module is connected.

7) Menu « User » - « OUTPUTS TEST » [0711]



« OUTPUTS TEST » menu will allow you to control relays or 4...20mA outputs to set pumps.

Press to open following screen.

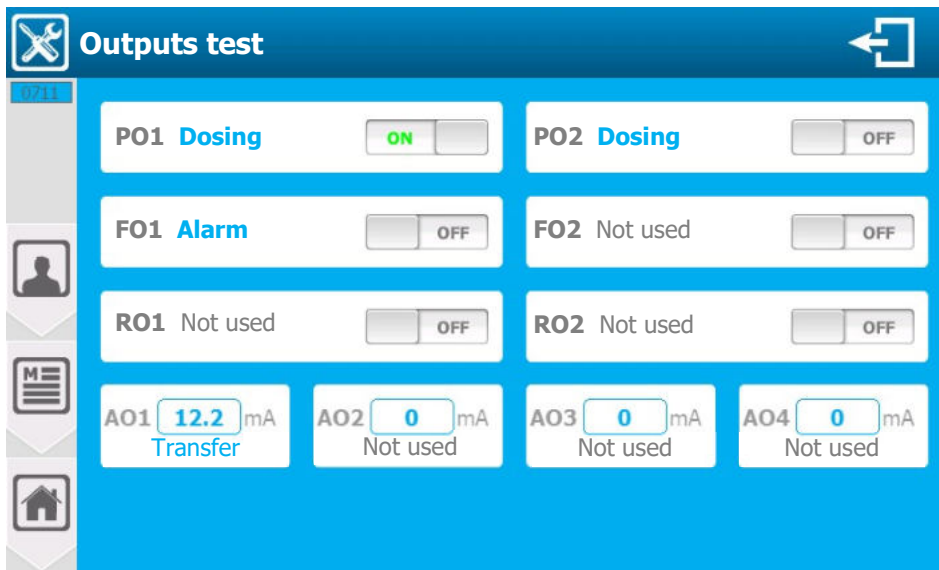

➤ **PO1 Dosing**

- Output name and function affected, press to toggle ON/OFF the relay. Each press reverses the state.



Relay output is inactive



Relay output is active

➤ **AO1 Transfer**

- Output name and function affected, press to open the numeric keyboard and enter the desired value



Even unaffected outputs can be tested.

8) Menu « User » - « INFO » [0811]

« INFO » menu will allow you to view the various versions of the installed modules as well as the serial number of the device.
Press to open following screen.

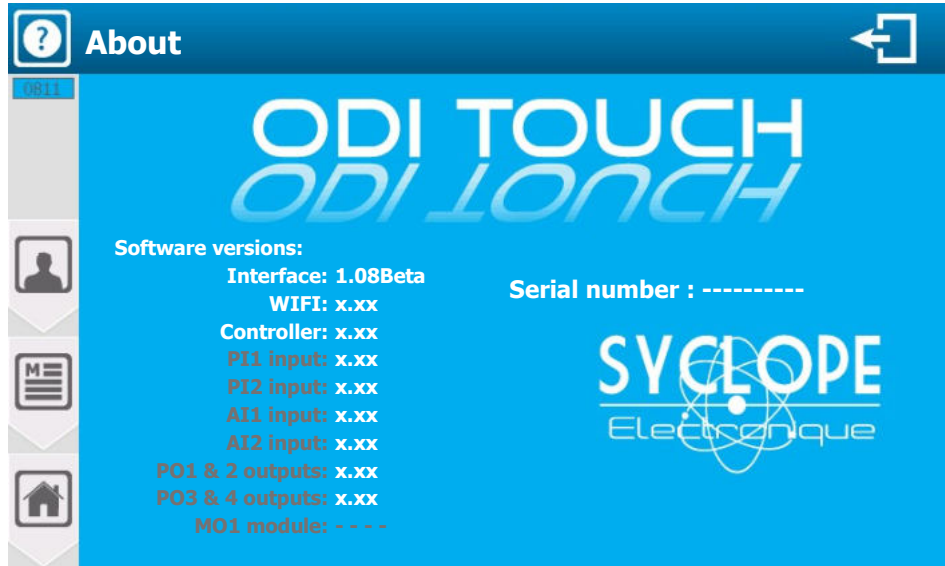

➤ **Software versions**

- **ODITOUCH** is composed of several firmware, it's possible on this screen to see the installed module and their versions.

➤ **Serial number**

- Your device serial number (Unique).



If an element is greyed out this means that the function isn't available.

VIII. Service / Maintenance

The device is maintenance-free.

The device must be cleaned with a clean and dry cloth.

Repairs can only be carried out by qualified technicians and must be carried out in our SAUVAGNON factory.

Verify that the device is in a safe state after repairing it.

For any problem on your device or for treatment advice, do not hesitate to contact our after-sales services.



SYCLOPE Electronique S.A.S.

Z.I. Aéropole Pyrénées

64 230 SAUVAGNON

Tel : (33) 05 59 33 70 36

Fax : (33) 05 59 33 70 37

Email : service-technique@syclope.fr

© 2018 by SYCLOPE Electronique S.A.S.
Sous réserve de modifications.