

SYCLOPE ODITouch® Controller for public swimming pool (Part 1)



Installation and starting instructions



Reference: DOC0459

Rev: 1.1

Part of the general documentation

- ▶ Part 1: Installation and starting instructions
- Part 2: General programming instructions
- Part 3: Communication programming instructions

General information:

SYCLOPE Electronique 2017 -2019[®] Manual of 04/02/2020 Rev 1.1

Analysers/Controllers for swimming pools.

Product line ODITouch[®]

Part 1: Installation and starting instructions (Ref: DOC0459)

Editor :



SYCLOPE Electronique S.A.S.

Z.I. Aérople pyrénées

Rue du Bruscos

64 230 SAUVAGNON - France –

Tel: (33) 05 59 33 70 36

Fax: (33) 05 59 33 70 37

Email: syclope@syclope.fr

Internet: <http://www.syclope.fr>

© 2017 by SYCLOPE Electronique S.A.S.

Subject to modification

Contents

I. Generality.....	5
1) Scope	5
2) FCC conformity.....	6
3) Use of the document	7
4) Symbols and signs.....	7
5) Storage and transport.....	8
6) Packaging	8
7) Warranty	8
II. Safety and environmental instructions.....	9
1) Use of the equipment	9
2) User obligations	9
3) Risk prevention	9
4) Identification and localization of the nameplate.....	10
5) Disposal and conformity.....	11
III. Technical characteristics and functions.....	12
1) Technical characteristics	12
2) Main functions.....	13
3) Radio technologies in equipment.....	13
4) Parameters and measurement scales.....	13
IV. Installation et connections	15
1) Installation conditions.....	15
2) Wall installation of the device.....	15
3) Open / Close transparent door	16
4) Open / Close the terminal cover	16
5) Tightening torque.....	17
a) Cable gland.....	17
b) Terminal blocks	17
6) Electrical connections	17
7) Changing the internal fuse of PO1 and PO2 outputs	18
8) Primary power connections	19
9) Measurement inputs connections.....	20
a) Potentiometric inputs PI1 & PI2.....	20
b) Isolated analog inputs 4...20mA AI1 & AI2.....	21
c) Analog inputs 4...20mA NOT isolated AI3 & AI4.....	22
d) Digital inputs DI1 to DI4	24
10) Self-powered relays outputs connections (PO1 et PO2).....	26
11) Potential-free relay connections (FO1 et FO2)	27
12) Electronic relay outputs connections (RO1 et RO2).....	28
13) 4...20mA outputs connections (AO1 to AO4)	29
14) Power supply output connection (PWR)	30
15) RS485 communication bus connections.....	30
a) Connection to a USB port on a computer	30
b) Polarization and termination of the RS485 bus	31
V. General use	32
VI. Commissioning the SYCLOPE ODITouch®	33
VII. Display mode and type.....	34

1)	<u>Main screen display</u>	<u>34</u>
	a) The upper banner.....	35
	b) Lower banner.....	37
	c) Display details of the "Small x6" channels	39
	d) Display details of the "Large x3" channels.....	41
2)	<u>"Detailed" display of a channel</u>	<u>43</u>
3)	<u>Graphical channel history display.....</u>	<u>48</u>
VIII. Input mode		52
1)	<u>Installer or User code entry screen</u>	<u>52</u>
2)	<u>Numerical value entry screen</u>	<u>52</u>
3)	<u>Alphanumeric keyboard</u>	<u>53</u>
	a) « Shift » key	53
	b) « Caps lock » key	53
	c) « Keyboard type » key.....	54
	d) « Other characters » key	54
	e) « Back » key	54
	f) « Enter » key	54
	g) « Close » key	54
	h) Special case of access to accented character keys.	54
4)	<u>Main input elements</u>	<u>55</u>
	a) Opening a selection list.....	55
	b) Multi selection button	55
	c) Unique selection button	55
	d) Input button	55
	e) Action button	55
	f) Selection list.....	56
	g) Navigation bar.....	57
	h) Lock symbol.....	57
IX. Annexes		58
1)	<u>"Configuration & Installation" – "Reset Factory" menu [0831]</u>	<u>58</u>
2)	<u>« User » - « DATE & TIME » menu [0311].....</u>	<u>60</u>
3)	<u>Backup battery changement.....</u>	<u>62</u>
4)	<u>Installation of the auxiliary module.....</u>	<u>63</u>

I. Generality

1) Scope

SYCLOPE ODITouch® analyser/controller you have purchased is a high-tech electronic device. It was designed and created carefully for your enjoyment and your peace of action.

Its remarkable faculty to adapt to different swimming pool structures allows it to settle in all difficult environments where mastery of water treatment is most decisive.

Thanks to ODITOUCH ease of use, their user-friendliness and their remarkable technicality, you will fully enjoy its many possibilities and will be assured of a perfect control and perfect monitoring of the quality of the water in your swimming pool (public, Olympic, nautical stadiums, etc.).

You will find in the instructions that follow, all the information needed for the installation, use and maintenance of your new equipment.

- Packaging
- Installation
- Basic equipments
- Specifications
- Commissioning instructions
- Safety instructions

If you need more information or if you encounter problems that not have been specified in this guide, please quickly contact your retailer or SYCLOPE Electronique S.A. sales department, either at the agency or office in your area, or at technical/quality service at our head office. We will do our best to help you and make you enjoy our advice and our knowledge in the field of measurement and treatment of pools water.

Contact: Service-technique@syclope.fr

2) FCC conformity

The **SYCLOPE ODITouch®** controller complies with Part 15 of the FCC Rules. Operation is subject to the following two conditions:

(1) this device may not cause harmful interference (2) this device must accept any interference received, including interference that may cause undesired operation
FCC Regulations state that unauthorized changes or modifications to this equipment may void the user's authority to operate it.



This equipment has been tested and found to comply with the limits for a Class B digital device, pursuant to Part 15 of the FCC Rules. These limits are designed to provide reasonable protection against harmful interference in a residential installation. This equipment generates, uses, and can radiate radio frequency energy and, if not installed and used in accordance with the instructions, may cause harmful interference to radio communications. However, there is no guarantee that interference will not occur in a particular installation.

If this equipment does cause harmful interference to radio or television reception, which can be determined by turning the equipment off and on, the user is encouraged to try and correct the interference by one or more of the following measures:

- Reorient or relocate the receiving antenna.
- Increase the separation between the equipment and receiver.
- Connect this equipment into an outlet on a circuit different from that to which the receiver is connected.
- Consult the dealer or an experienced radio/TV technician for help.

Changes and modifications not expressly approved by the manufacturer could void the user's authority to operate this equipment.

Remark: To ensure compliance with the FCC regulations on electromagnetic interference for a class B device, use cables properly shielded and connected to the ground as recommended in this manual. The use of a cable that is not properly shielded or earthed for risk of violating the FCC rules.

Radio Frequency (RF) Exposure Compliance of Radiocommunication for mobile Apparatus To satisfy FCC RF Exposure requirements for mobile devices, a separation distance of 20 cm or more should be maintained between the antenna of this device and persons during operation. To ensure compliance, operation at closer than this distance is not recommended. This transmitter must not be co-located or operating in conjunction with any other antenna or transmitter.

Contains:

- WiFi module: FCC ID : 2AC7Z-ESPWROOM02

This device complies with part 15 of the FCC Rules. Operation is subject to the following two conditions: (1) This device may not cause harmful interference, and (2) this device must accept any interference received, including interference that may cause undesired operation.

- GSM module: FCC ID: UDV-0912142009007

This device complies with part 15 of the FCC Rules. Operation is subject to the following two conditions: (1) This device may not cause harmful interference, and (2) this device must accept any interference received, including interference that may cause undesired operation. (for FCC)

3) Use of the document

Please read carefully the entire document before starting the installation and the commissioning of the controller device, in order to ensure the safety of swimmers, users and equipment's.

The information provided in this document must be strictly observed. **SYCLOPE Electronique S.A.S.** declines all responsibility in cases where failure to comply with the instructions of this documents.

The following symbols and pictograms will be used to facilitate reading and understanding of these instructions.

- Information
- ▶ Action to do
- Element of a list or enumeration

4) Symbols and signs



Identification of a continuous volage or current



Identification of an alternative voltage or current



Protective ground



Functionnal ground



Risk of injury or accident. Identifies a warning concerning a potentially dangerous risk. The documentation must be consulted by the user with each time the symbol is notified. If the instructions are not respected, this presents risks of death, physical injuries or property damages.



Electric hazard. Identifies a warning statement relative to a mortal electric danger. If the instructions are not strictly respected, this implies an inevitable risk of physical injuries or death.



Risk of incorrect operation or damage for the device



Comment or particular information.



Recyclable element

5) Storage and transport



It is important to store and to transport the **SYCLOPE ODITOUCH** controller in its original packaging in order to minimize risk of damage.

Furthermore, the package must be stored in an environment that is protected against humidity and exposure to chemical products.

Environmental conditions for transport and storage:

Temperature: -10 °C to 70 °C

Air humidity: Maximum of 90% with no condensation

6) Packaging



The device is delivered without power cable.

Caps of the box are pre-drilled and fitted with corresponding cable glands conform to the maintenance of IP65 protection. Cables used must be adapted to them in order to respect the protection index.

Shielded cables for connecting pH and ORP electrodes are not supplied.

The controller is delivered with:

- ✓ **SYCLOPE ODITouch**® central analyser/controller
- ✓ Installation and starting instructions
- ✓ General programming instructions
- ✓ Communication programming instructions (Option)

7) Warranty

The warranty is provided according to the terms of our general conditions of sale and delivery as long as the following conditions are met:

- Use of the equipment according to the instructions of this notice
- No modifications of the equipment which may modify its behaviour and no incorrect manipulation
- Respect for the electrical safety conditions



Consumable material is no longer covered by warranty as soon as it's put into service.

II. Safety and environmental instructions

Please:

- Read this manual carefully before the unpacking, the installing or the commissioning of this equipment
- Take into account all the hazards and of recommended precautionary measures

The failure to respect these procedures can result in serious injury to users or damaging the device.

1) Use of the equipment

SYCLOPE ODITouch® controllers has been designed to measure and control pH, Chlorine, Bromine (BCDMH) using appropriate sensors and actuator controls within the scope of use described in this manual.



All other uses are considered to be non-conforming and must therefore be forbidden. SYCLOPE Electronique S.A.S. will not be responsible in any case for any damage that result from such uses.



The 12V Ext must not be used when the product is connected to an electrical network within the following range: 100 – 208V



Do not use the device for measurements on the network directly, but only on the secondary circuit under very low safety voltage.

2) User obligations

The user undertakes not to allow its employees to work with the **SYCLOPE ODITouch®** controller described in this manual unless they:

- Are aware of the fundamental instructions relating to work safety and prevention of accidents
- Are trained in the use of the device and its environment
- Have read and understood these instructions, warnings and manipulation rules

3) Risk prevention



The installation and connection of the **SYCLOPE ODITouch®** controller should be only performed by specialized personnel and qualified for this task.
The installation must comply with the current safety standards and instructions!



Before opening the controller or manipulate the relay outputs, always remember to switch-off the primary power supply!
Never open the controller when it is powered on!
Maintenance operations and repairs should be only performed by trained and specialized personnel!



Take care when choosing the location for installing the controller!
SYCLOPE ODITouch® controller should not be installed in a hazardous environment and should be protected against splashing with water or chemical products. It should be installed in a dry, well-ventilated and isolated location.



Make sure that the chemical sensors used with this controller correspond well to the chemicals used. Refer to the individual technical note of each sensor. Chemistry of water is very complex, in case of doubt, contact immediately our engineering service or your approved installer/reseller.



Chemical sensors are sensitive elements using consumable parts. They must be supervised, maintained and calibrated regularly using specific calibrator systems not-provided with this equipment. In the event of defect, a surplus possible hazard of chemical injections can be noted. In the doubt, a service contract must be taken near your reseller/installer or failing this near our engineering services. Contact your approved installer/reseller or our business service for more information.

4) Identification and localization of the nameplate

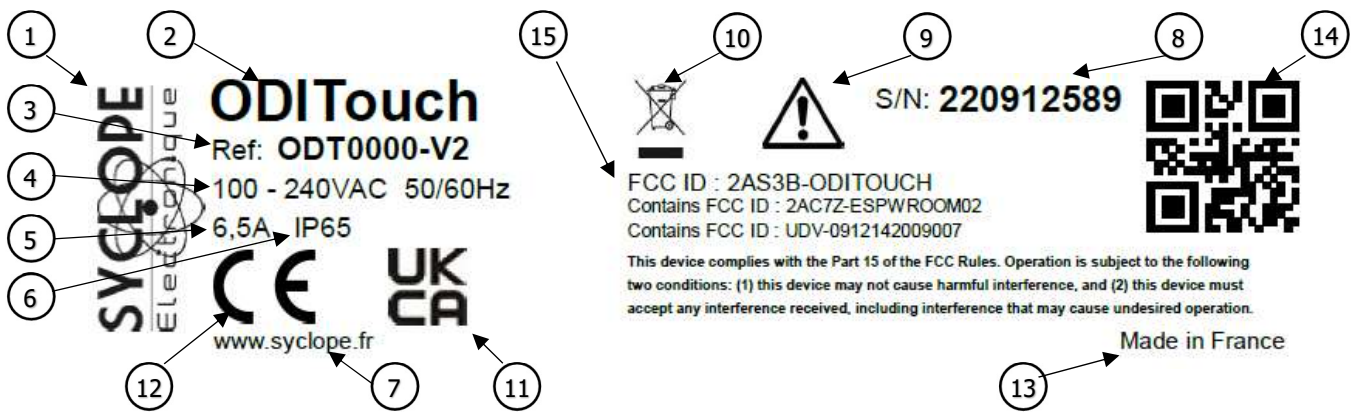

① Manufacturer's label	⑨ Particular risk. Read the manual
② Model of the product / Trade Mark	⑩ Product which can be recycled
③ Reference of the product	⑪ UKCA approved
④ Range of power supply	⑫ CE approved
⑤ Values of maximum current	⑬ Country of manufacture
⑥ Class of protection	⑭ Manufacturer square code
⑦ Identification of the manufacturer	⑮ FCC ID
⑧ Serial number	

Nameplate



5) Disposal and conformity

The recyclable packaging of the **SYCLOPE ODITouch**[®] equipment must be disposed of according to current regulations.



Elements such as paper, cardboard, plastic or any other recyclable elements must be taken to a suitable sorting center.



According to European directive 2012/19/EC, this symbol means that as of 4 July 2012 electrical appliances cannot be thrown out together with household or industrial waste. According to current regulations, consumers within the European Union are required, as of this date, to return their used devices to the manufacturer, who will take care of disposing them at no extra expense.



According to European directive 2011/65/EC, this symbol means that the **SYCLOPE ODITouch**[®] controller is designed in compliance with the restrictions on hazardous substances.



According to low-voltage directive (2014/35/UE) and the electromagnetic compatibility directive (2014/30/UE), this symbol means that the device has been designed in compliance with the previously cited directives.



In accordance with part 15 of the FCC regulation (Federal communications commission), this symbol indicates that the device was tested and approved under the respect and the conditions of the limits for a Class B digital device.



The product complies with the requirements of IEC 61326-1 relating to immunity and emissions concerning electromagnetic compatibility in a basic environment.

III. Technical characteristics and functions

1) Technical characteristics

Main features		
Type(s)	Specification(s)	Marker(s)
Consumption	6,5A Max (Without connected dosing accessories)	-
Power supply requirements	100-240VAC 50/60Hz	-
Electrical protection	Fuses 550 mA. Reset by power interruption	F5 & F6
Operating temperature (°C)	0 °C to 45 °C (32 °F to 113 °F)	-
Case material	Polycarbonate	-
Dimensions of the case	Length: 280 mm (11 pouces) Width: 219 mm (8.6 pouces) Height: 156 mm (6.1 pouces)	-
Case weight	0,850 kg	-
Indicator light (LED)	Group 0	
Display	5 inch color LCD screen Resistive touch	-
Environnement		
Storage temperature	-10 °C to 70 °C (10 °F to 158 °F)	-
Max operating altitude	2000 meters	
Humidity	Max. 90% without condensation	-
Protection rating	IP 65	-
Product certification	CE	-
Max overvoltage category of the power supply network	CAT II	
Pollution degree	DP 2	
Electromagnetic compatibility	Class B disruption tests comply with EN61326-1 Class B disruption tests comply with EN61326-2-6 Class B disruption tests comply with EN55011 Harmonics tests comply with EN61000-3-2 Harmonics tests comply with EN61000-3-3 Immunity tests comply with EN61000-4-2 Immunity tests comply with EN61000-4-3 Immunity test EN61000-4-4 Immunity tests comply with EN61000-4-5 Immunity tests comply with EN61000-4-6 Immunity tests comply with EN61000-4-8 Immunity tests comply with EN61000-4-11	-
Standard	EN 61000 Electromagnetic compatibility (CEM) EN 61326 Electrical measuring, control and laboratory equipment for a standard environment (class B home use)	-
Inputs		
Potentiometric inputs	2 inputs ($\pm 1V$; Insulation 35VDC ; Impedance 1M Ω)	PI1 & PI2
4-20mA Inputs	2 Isolated inputs 24VDC no-load (0 to 25 mA ; Insulation 35VDC ; Impedance 160 Ω)	AI1 & AI2
	2 Non-isolated inputs 24VDC no-load (0 to 25 mA ; Non-isolated ; Impedance 160 Ω)	AI3 & AI4
Digital inputs	4 inputs (0 to 12 VDC ; Non-isolated ; Impedance 5k Ω)	DI1 to DI4
USB inputs	USB connector on front (Exclusive use of USB key for Firmware Update) (5VDC ; 500mA)	-
Outputs		
Relay outputs	2 self-powered relay outputs 3A Max ; 240VAC Max	PO1 & PO2
Relay outputs	2 ON/OFF relay outputs 3A Max ; 48VAC Max	FO1 & FO2
Relay outputs	2 electronic relay outputs 50mA Max ; 48VAC Max	RO1 & RO2
Analog outputs	4 0/4...20 mA analog outputs Max ; 12VDC Max ; 500 Ω	AO1 to AO4

Power output	1 12V power output ; 500mA	
Communication port		
RS485	1 RS485 communication port	RS485
Ethernet	1 Ethernet output	ETH
Protection of dosing outputs		
Internal fuse	2 TR5 3,15 A 250 V Time delay fuses	F1 & F2
Save		
Button cell	Type BR2032	Bat1

2) Main functions

Main functions		
Fonction(s)	Spécification(s)	Remarque(s)
Regulation mode	P.I.D	Injection time calculated in % 240s relay injection cycle time.
	Hysteresis	
	All or nothing	
Type of actuators	Power relay outputs	Width modulation control
Direction of regulation	Up or down	
Alarms	Low and high alarms	Expressed in actual measurement value High and low threshold control
Controlling	Floawrate control	Controlling injection to control wate circulation.
	Tank level	Controlling injection to control the level of product to be injected.
Configuration	Choice of standard configuration	Automatic machine setup
Maintenance	Maintenance assistance	Control of regulatory device

3) Radio technologies in equipment

Radio technologies			
Technologies	Number of antenna	Radiated powers	Frequency bands of use
WIFI	1	< 20dBm	2400 MHz to 2483.5 MHz 2.4 GHz Band Exclusion Band : [2280 MHz – 2603.5 MHz]

4) Parameters and measurement scales

Measures and regulations			
Parameters	Measuring scale	Customer measuring scale	Accuracy
Temperature	-5 to 45°C		± 0,5 %
	0 to 100 °C		± 0,5 %
		-10 to 100°C	± 0,5 %
pH	0 to 14 pH		± 0,5 %
	1 to 12 pH		± 0,5 %
		-1 to 15 pH	± 0,5 %
ORP	0 to 1000 mV		± 0,5 %
	-1000 to 1000 mV		± 0,5 %
		-1000 to 1000 mV	± 0,5 %
Free chlorine	0,01 to 0,5 mg/l		± 0,5 %
	0,02 to 2 mg/l		± 0,5 %
	0,05 to 5 mg/l		± 0,5 %
	0,1 to 10 mg/l		± 0,5 %
	0,2 to 20 mg/l		± 0,5 %
	0,5 to 50 mg/l		± 0,5 %
	1 to 100 mg/l		± 0,5 %

		0 to 2000 mg/l	± 0,5 %
Active chlorine	0,02 to 2 mg/l		± 0,5 %
	0,1 to 10 mg/l		± 0,5 %
		0 to 2000 mg/l	± 0,5 %
Total chlorine	0,01 to 0,5 mg/l		± 0,5 %
	0,02 to 2 mg/l		± 0,5 %
	0,05 to 5 mg/l		± 0,5 %
	0,1 to 10 mg/l		± 0,5 %
		0 to 2000 mg/l	± 0,5 %
Chlorite	0,01 to 0,5 mg/l		± 0,5 %
	0,02 to 2 mg/l		± 0,5 %
		0 to 2000mg/l	± 0,5 %
ClO2 (Chlorine dioxide)	0,01 to 0,5 mg/l		± 0,5 %
	0,02 to 2 mg/l		± 0,5 %
	0,1 to 10 mg/l		± 0,5 %
		0 to 2000 mg/l	± 0,5 %
H2O2 (Peroxide)	0,5 to 50 mg/l		± 0,5 %
	2 to 200 mg/l		± 0,5 %
	20 to 2000 mg/l		± 0,5 %
		0 to 2000 mg/l	± 0,5 %
BCDMH	0,02 to 2 mg/l		± 0,5 %
	0,2 to 10 mg/l		± 0,5 %
	0,4 to 15 mg/l		± 0,5 %
		0 to 2000 mg/l	± 0,5 %
DBDMH	0,1 to 1 mg/l		± 0,5 %
	0,1 to 5 mg/l		± 0,5 %
	0,1 to 10 mg/l		± 0,5 %
		0 to 2000 mg/l	± 0,5 %
Free bromine	0,1 to 1 mg/l		± 0,5 %
	0,1 to 5 mg/l		± 0,5 %
	0,1 to 10 mg/l		± 0,5 %
		0 to 2000 mg/l	± 0,5 %
PerAcetic Acid	2 to 200 mg/l		± 0,5 %
	10 to 2000 mg/l		± 0,5 %
		0 to 2000 mg/l	± 0,5 %
Ozon	0,1 to 2 ppm		± 0,5 %
		0 to 2000 ppm	± 0,5 %
O2 (Oxygen)	0,2 to 10 ppm		± 0,5 %
	0,2 to 20 ppm		± 0,5 %
		0 to 2000 ppm	± 0,5 %
PHMB	1 to 100 mg/l		± 0,5 %
		0 to 2000 mg/l	± 0,5 %
Turbidity	0,2 to 100 NTU		± 0,5 %
		0 to 2000 NTU	± 0,5 %
Conductivity	0 to 5 mS/cm		± 0,5 %
	0 to 10 mS/cm		± 0,5 %
	0 to 20 mS/cm		± 0,5 %
	0 to 50mS/cm		± 0,5 %
	0 to 100 mS/cm		± 0,5 %
	0 to 2000 mS/cm		± 0,5 %
		0 to 2000 mS/cm	± 0,5 %
Flowrate	0 to 20 l/min		± 0,5 %
	0 to 50 l/min		± 0,5 %
	0 to 200 l/min		± 0,5 %
		0 to 2000 l/min	± 0,5 %
Volume		0 to 2000 l	± 0,5 %

IV. Installation et connections

1) Installation conditions



To guarantee the user safety and to ensure correct operation of your **SYCLOPE ODITouch®**, please observe the following installation instructions:

- Install the controller in a dry location
- The controller must be protected against rain, frost and direct sunlight
- The room temperature must range between 0°C and 45°C, with no condensation
- Choose an installation location free from vibration, on a suitable support and with no deformation
- Install the device so that it does not make it difficult to operate the disconnecting circuit (fuse or circuit breaker)



If these instructions are not observed:

- The controller risks to be damaged,
- The measurements can be disrupted,
- The warranty is not applicable!

2) Wall installation of the device



Prior to installing the devices and connections of cables, pipes and fittings, cut power supplies! The IP54 protection class is guaranteed only if the closure caps of the **SYCLOPE ODITouch®** are closed and the wires correspond to the diameter of the cable gland!

- ▶ Drill 3 holes \varnothing 5 mm in accordance with the drilling plan below :

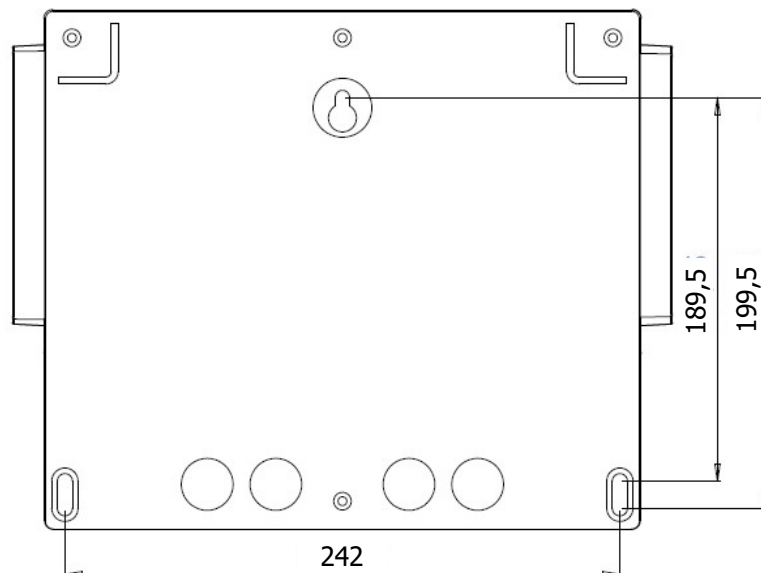

- ▶ Introduce the 5mm dowels using a hammer
- ▶ Fix the top screw first without tightening it completely
- ▶ Place the lower screws and tighten them
- ▶ Tighten the upper screw
- ▶ Make sure the housing is stable and level

3) Open / Close transparent door



In order to guarantee IP65 class, the transparent door must absolutely be closed after use while ensuring the quality of the closure seal.

The case has a closing system with automatic locking as soon as its handling is carried out correctly.

To open the transparent door :

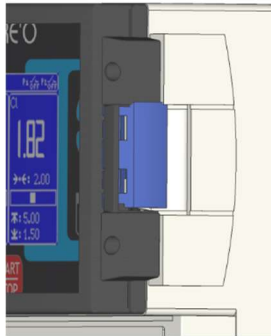

Door locked ...

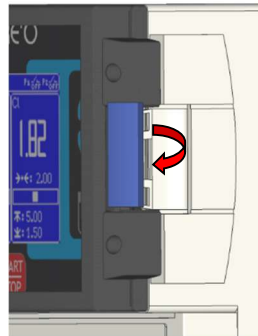

Lift the lock and pull towards the front of the device

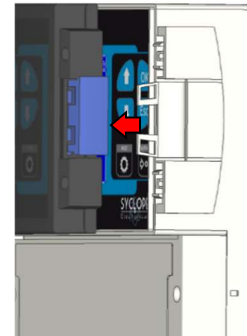

Door opened!

To close and lock the transparent door :

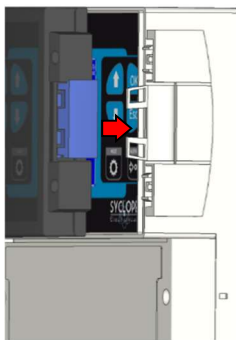

Put your fingers behind the lock, and bring the door with your thumb...

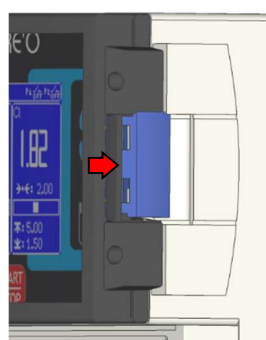

With the palm of your hand, press on the transparent door and tighten with your hand to lock.

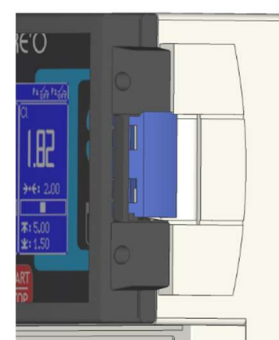

Door locked!

4) Open / Close the terminal cover



In order to guarantee IP65 class, the terminal cover must absolutely be closed after use while ensuring the quality of the closure seal.

Use an appropriate screwdriver to unscrew the 2 fixing screws and open the terminal cover.

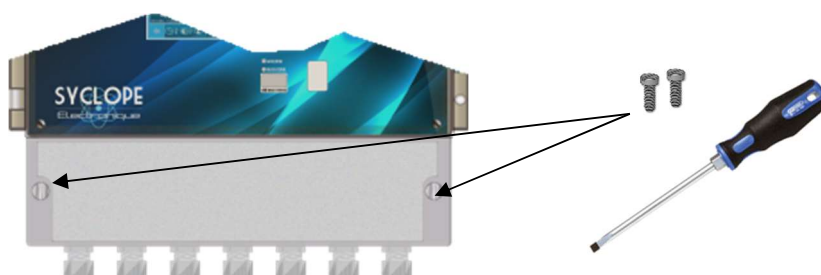

5) Tightening torque

a) Cable gland

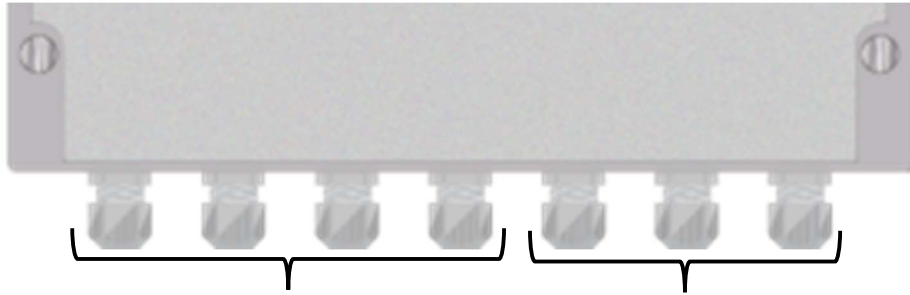

Max cable section via cable gland.	3 x (2-5mm)	1 x (6-12mm)
Cable gland tightening torque.	0.7 N.m	2 N.m

b) Terminal blocks

The tightening torque of the screws of different terminal block is 0.5 N.m

6) Electrical connections

Electrical installations must be carried out in accordance with the standards in force and by authorized personnel!

A 30-mA differential circuit breaker must be installed!

A 10A circuit breaker must be installed near the device and easily accessible in order to cut the primary supply. It must be marked as the cut-off circuit of the device.

Before making the connections, cut off the power supplies!



Preferably use single-strand cables

Otherwise, it is essential to use a crimped cable ends to ensure that no strand can come into contact with neighbouring cables!

Secure the wire connections on the terminal blocks using a cable tie.



SYCLOPE ODITouch® must be slaved to the filtration of the swimming pool using digital input.

Internal protection :

SYCLOPE ODITouch® is protected by two resettable fuses (see table "General characteristics" page 14) and by a varistor against overvoltage of 275V.



The self-powered power relay outputs PO1 and PO2 are each protected by a TR5 fuse (see table "General characteristics" page 14).

7) Changing the internal fuse of PO1 and PO2 outputs

SYCLOPE ODITouch® has a spare fuse located in position F5, which allows you to quickly replace a fuse if necessary. If you are led to using it, don't forget to replace it...



Cut off the power supply, before changing the fuse!



Always use a fuse identical to the original one. Don't replace with a higher intensity!

- Cut off the power supply
- Open the transparent door and unscrew the 4 front screws using an appropriate screwdriver.
- Carefully disconnect the connection flat cable connecting the bottom card and the upper part of the device.

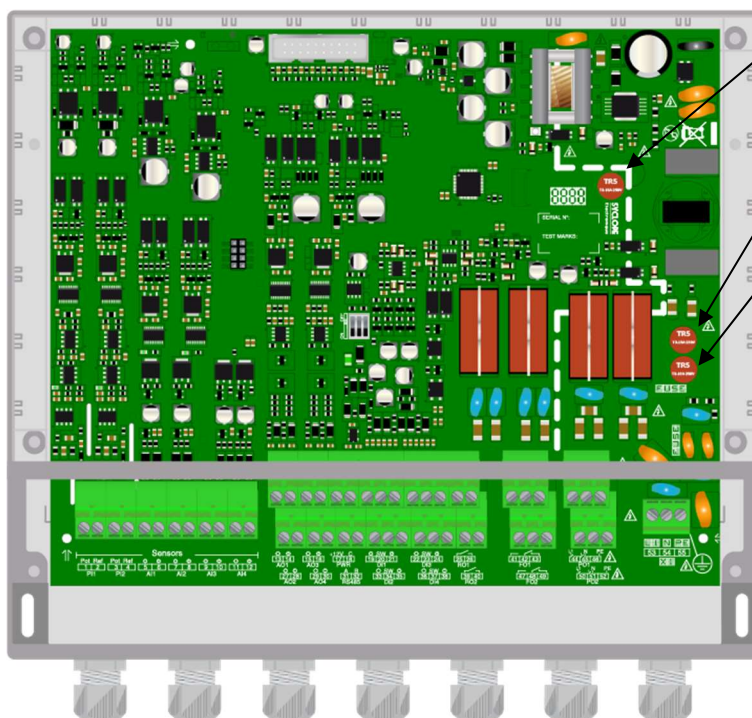
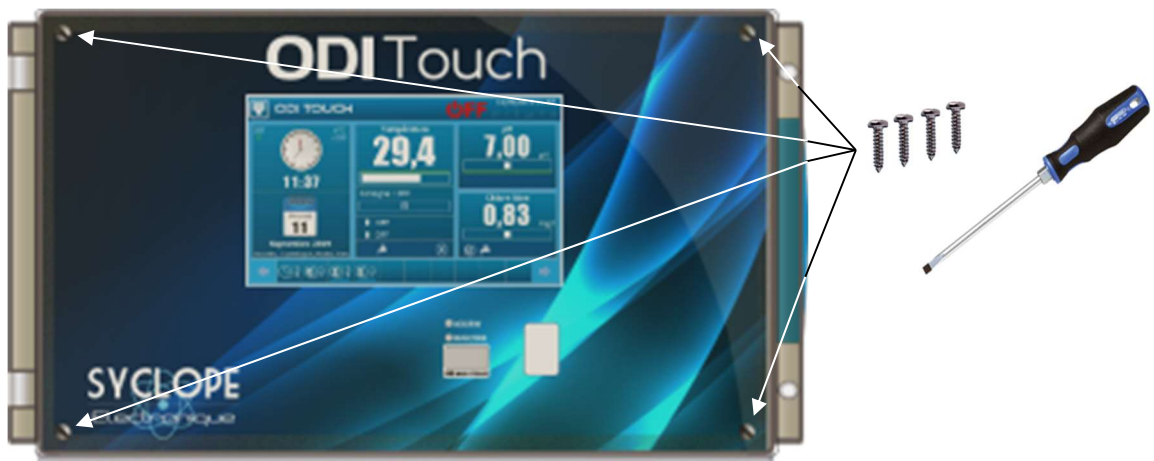

Spare fuse F5 TR5

Fuse F2 (TR5)

Fuse F3 (TR5)

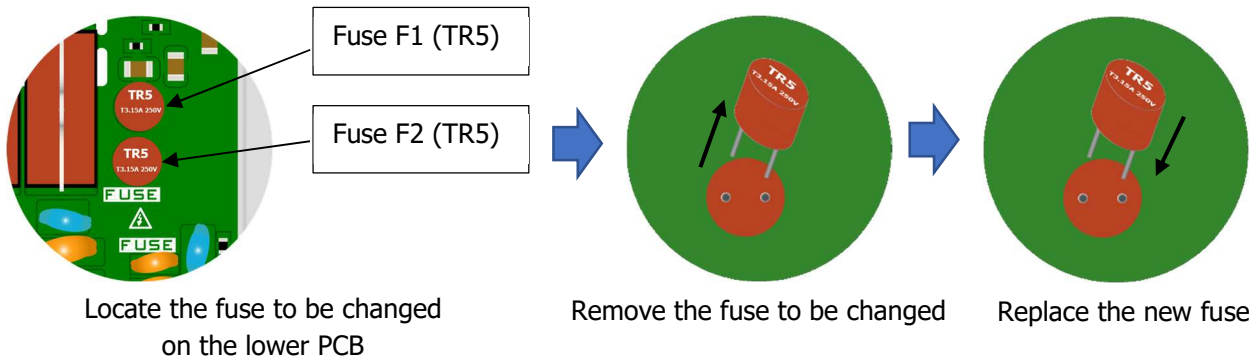

- Reconnect the flat cable between the cards and reassemble the front panel using the 4 fixing screws. Don't overtighten because the screws are fixed in the plastic case.



Reconnect the flat cable and replace the front panel before switch On.

8) Primary power connections



SYCLOPE ODITouch® has a switch-mode power supply. It can be powered by an alternating voltage between 100V and 240V 50/60Hz.



- ▶ Use a 3-point 1.5 mm² to wire the power supply
- ▶ Strip the 3 wires on 7mm
- ▶ Pass the 3-point cable through a cable gland
- ▶ Connect the phase on L1 and the neutral on the N of the main terminal block X1
- ▶ Connect the earth on the PL1 stud using an M4 eyelet terminal
- ▶ Tighten the cable gland to seal.

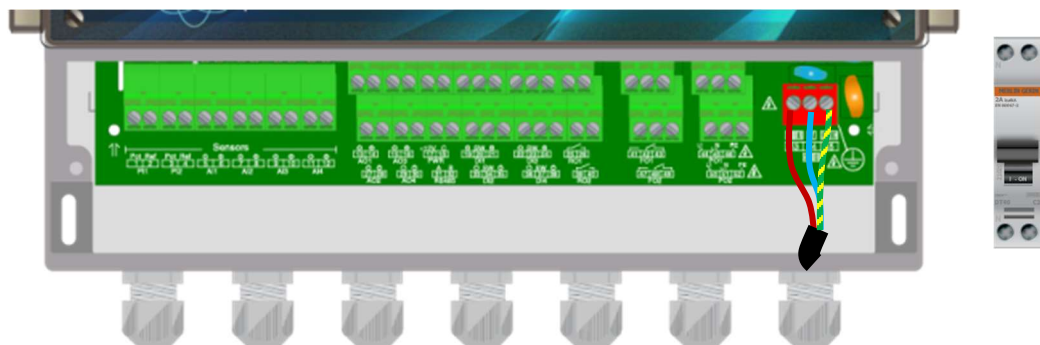

Your **SYCLOPE ODITouch®** doesn't have a power switch. So it's directly supplied when it's connected to the mains.



Your **SYCLOPE ODITouch®** doesn't have a power switch. It is therefore necessary to install a 10A circuit breaker upstream of the device.

9) Measurement inputs connections

SYCLOPE ODITouch® has ten inputs :

- 2 Inputs PI1 & PI2 potentiometric for pH and ORP sensors
- 2 Inputs AI1 & AI2 4-20mA isolated for temperature, chlorine or bromine measure
- 2 Inputs AI3 & AI4 4-20mA not isolated for temperature, chlorine or bromine measure
- 4 Inputs DI1 to DI4 digital for sensor.

a) Potentiometric inputs PI1 & PI2

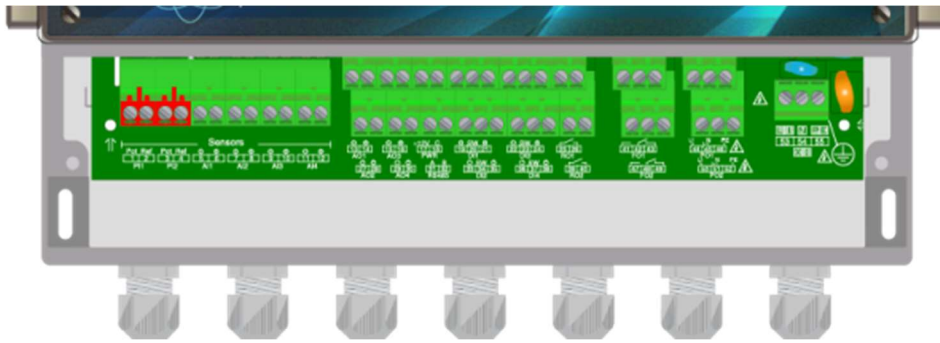

Controller has two potentiometric inputs on which a pH or ORP sensor can be connected.

The definition of supported sensors is as follows:

	pH 1...12	pH 0...14	Customer*
pH (input PI1 or PI2)	•	•	•
(*) : The scale of the customer can be defined between -1 and 15 (pH)			

	0...1000mV	+/- 1000mV	Customer*
ORP (input PI1 or PI2)	•	•	•
(*) : The scale of the customer can be defined between -1000 and 1000mV			

Connection of the sensor on PI1:

- ▶ Preferably use a shielded coaxial cable.
- ▶ Connect the core of the cable to the **Pot (1)** connection.
- ▶ Connect the shield on the **Ref (2)** connection.
- ▶ Tighten the cable gland to seal.



Connection of the sensor on PI2:

- ▶ Preferably use a shielded coaxial cable.
- ▶ Connect the core of the cable to the **Pot (3)** connection.
- ▶ Connect the shield on the **Ref (4)** connection.
- ▶ Tighten the cable gland to seal.

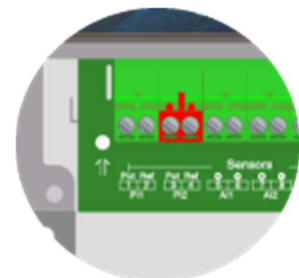

b) Isolated analog inputs 4...20mA AI1 & AI2

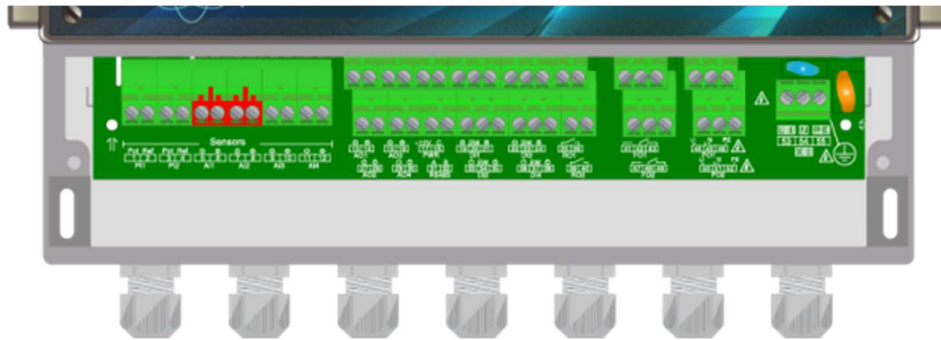

Controller has 2 isolated analog inputs 4...20mA on which a chlorine, bromine, ozone, hydrogen peroxide, peracetic acid, dissolved oxygen or PHMB sensor can be connected.

The definition of supported sensors is as follows:

	0,01...0,5mg/L	0,1...1mg/L	0,02...2mg/L	0,1...5mg/L	0,2...10mg/L	0,4...15mg/L	0,2...20mg/L	0,5...50mg/L	1...100mg/L	2...200mg/L	20...2000mg/L	Client*
Free chlorine	•		•	•	•	•	•	•	•			•
Active chlorine			•		•							•
Total chlorine	•		•	•	•							•
Chlorite	•		•									•
Chlorine dioxyde	•		•		•							•
Peroxide								•		•	•	•
Bromine BCDMH			•		•	•						•
Bromine DBDMH		•		•	•							•
Free bromine		•		•	•							•
Peracetic acid										•	•	•
Ozone			•									•
Dissolved oxygen					•		•					•
PHMB									•			•

* The scale of the customer can be defined between 0 and 2000 (ppb, ppm, NTU, µg/L, mg/L, g/L ou %)

Connection of the sensor on AI1:

- ▶ Preferably use a two-strand cable.
- ▶ Connect the sensor (+) strand to the **AI1 + (5)** connection.
- ▶ Connect the sensor (-) strand to the **AI1 - (6)** connection.
- ▶ Tighten the cable gland to seal.

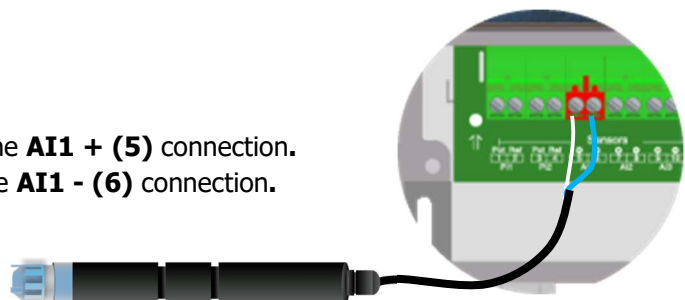

Connection of the sensor on AI2:

- ▶ Preferably use a two-strand cable.
- ▶ Connect the sensor (+) strand to the **AI1 + (7)** connection.
- ▶ Connect the sensor (-) strand to the **AI1 - (8)** connection.
- ▶ Tighten the cable gland to seal.

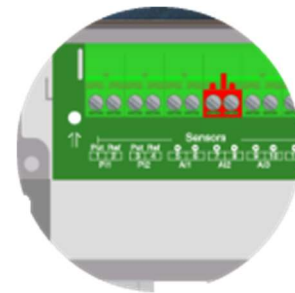

c) Analog inputs 4...20mA NOT isolated AI3 & AI4

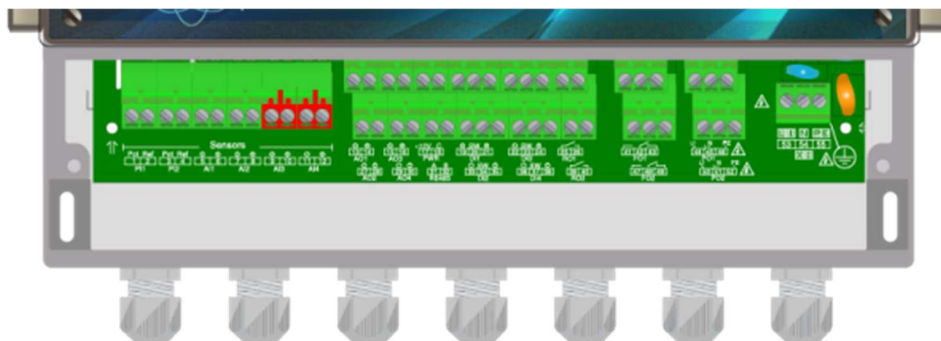

Controller has two analog inputs 4...20mA NOT isolated on which a temperature, conductivity, turbidity, flowrate or volume **Isolated** sensor can be connected.

The definition of supported sensors is as follows:

		0,2...100NTU	Customer*			-5...+45°C	Customer*
Turbidity		•	•	Temperature		•	•
(*) : The scale of the customer can be defined between 0 and 2000 (NTU or FNU)				(*) : The scale of the customer can be defined between -10 and 100 °C			

	0...5mS/cm	0...10mS/cm	0...20mS/cm	0...50mS/cm	0...100mS/cm	0...200mS/cm	Customer*
Conductivity	•	•	•	•	•	•	•
(*) : The scale of the customer can be defined between 0 and 2000 (µS/cm, mS/cm)							
							Customer*
Volume (4...20mA)							•
(*) : The scale of the customer can be defined between 0 and 2000 (L, m3)							

	0...20l/min	0...50l/min	0...200l/min	0...10m ³ /H	Customer*
Flowrate (4...20mA)	•	•	•		•
(*) : The scale of the customer can be defined between 0 and 2000 (L/min, L/H or m ³ /H) in 4...20mA or impulse input					

Connection of the sensor on AI3:

- ▶ Preferably use a two-strand cable.
- ▶ Connect the sensor (+) strand to the **AI3 + (9)** connection.
- ▶ Connect the sensor (-) strand to the **AI3 - (10)** connection.
- ▶ Tighten the cable gland to seal.

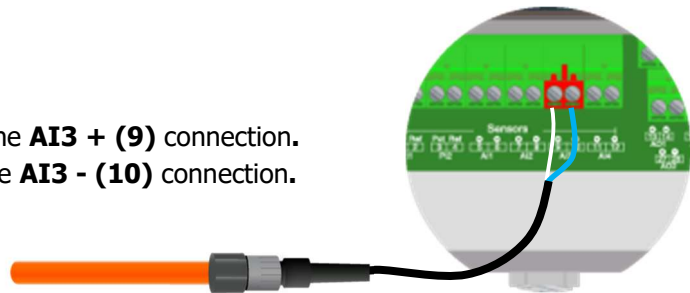

Connection of the sensor on AI4:

- ▶ Preferably use a two-strand cable.
- ▶ Connect the sensor (+) strand to the **AI4 + (11)** connection.
- ▶ Connect the sensor (-) strand to the **AI4 - (12)** connection.
- ▶ Tighten the cable gland to seal.

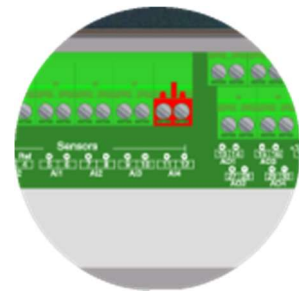

d) Digital inputs DI1 to DI4

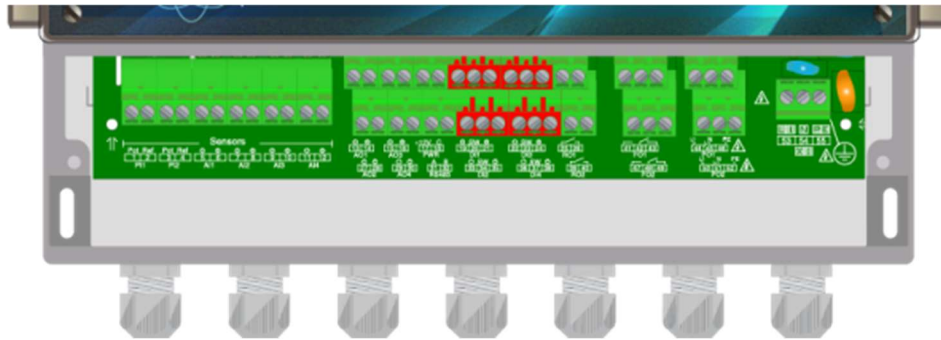

Controller has 4 digital inputs on which a tank bottom, flow, R.I.C (Remote Input Control), or other sensor can be connected.

The definition of supported sensors is as follows:

	0 ... 20l/min	0 ... 50l/min	0 ... 200l/min	0 ... 10m ³ /H	Customer*
Flow (impulsions)	•		•	•	•
(*): The scale of the customer can be defined between 0 et 2000 (L/min, L/H or m ³ /H) in 4...20mA or impulse input					

Connection of a R.I.C (Remote Input Control), tank bottom or other sensor on DI1:

- ▶ Preferably use a two-strand cable.
- ▶ Connect one sensor strand to the **DI1 sw (20)** connection.
- ▶ Connect the other sensor strand to the **DI1 - (21)** connection.
- ▶ Tighten the cable gland to seal.

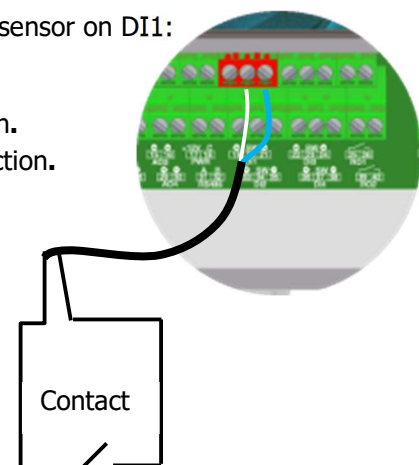

Connection of a flow switch sensor on DI2:

- ▶ Remove the protective sheath.
- ▶ Strip the wires on 7mm.
- ▶ Pass the cable through the cable gland.
- ▶ Connect the brown power strand to **DI2 + (33)**.
- ▶ Connect the blue power strand to **DI2 - (35)**.
- ▶ Connect the black contact strand to **DI2 sw (34)**.
- ▶ Tighten the cable gland to seal

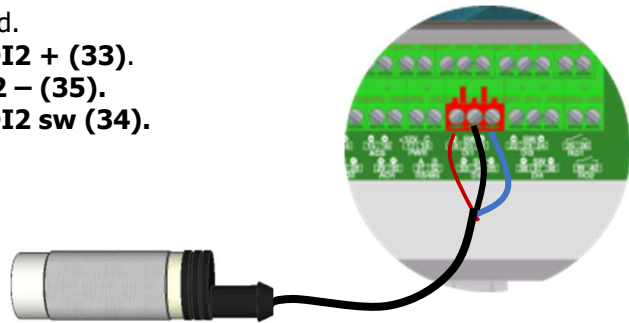

Connection of a flowmeter sensor on DI3:

- ▶ Preferably use a two-strand cable.
- ▶ Connect one sensor strand to the **DI3 sw (23)** connection.
- ▶ Connect the other sensor strand to the **DI3 - (24)** connection.
- ▶ Tighten the cable gland to seal.

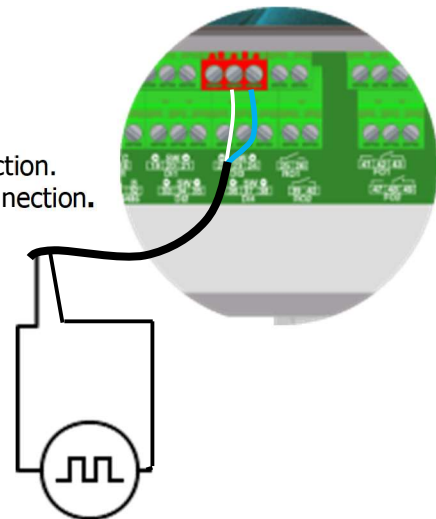

10) Self-powered relays outputs connections (PO1 et PO2)

The self-powered PO1 power relay output (Primary supply voltage = Voltage available on P3) can be used for dosing, alarm, timer...



These outputs have a permissible MAX current of **3A** and a MAX voltage of **240V**.

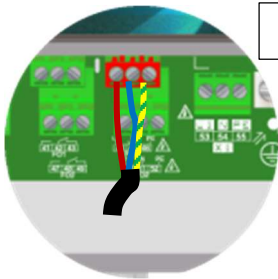
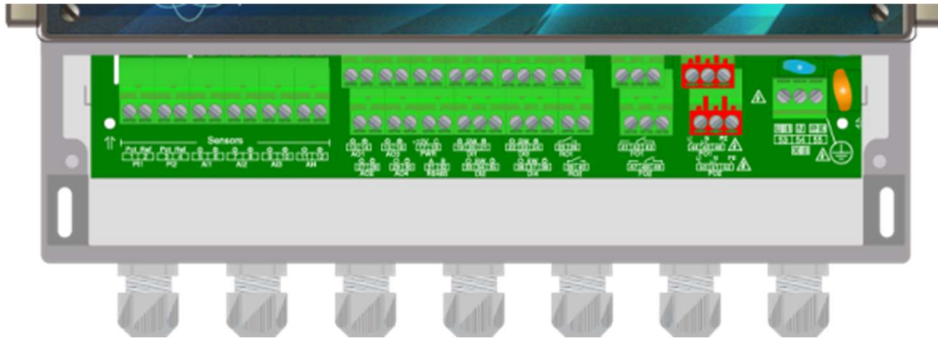

PO1

- ▶ Strip the 3 wires of the power cable of the dosing device on 7mm
- ▶ Pass the 3-point cable through a cable gland
- ▶ Connect the phase on **L1 (44)** and the neutral on **N (45)** of the PO1 mains terminal block
- ▶ Connect the earth on **PE (46)** of the PO1 mains terminal block
- ▶ Tighten the cable gland to seal.

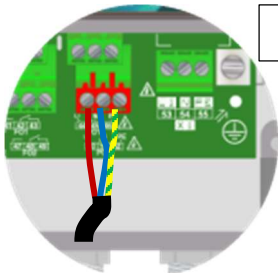

PO2

- ▶ Strip the 3 wires of the power cable of the dosing device on 7mm
- ▶ Pass the 3-point cable through a cable gland
- ▶ Connect the phase on **L1 (50)** and the neutral on **N (51)** of the PO2 mains terminal block
- ▶ Connect the earth on **PE (52)** of the PO2 mains terminal block
- ▶ Tighten the cable gland to seal.

11) Potential-free relay connections (FO1 et FO2)

The potential-free relay outputs can be used as alarm relays, regulation or be controlled in Timer mode as required.

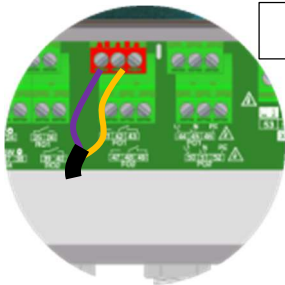
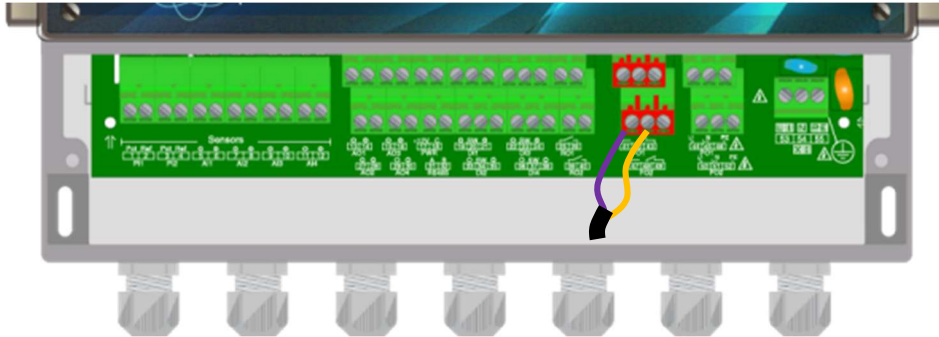

FO1

- ▶ Use a 2-wire cable with a section appropriate for the voltage and current.
- ▶ Remove the protective sheath
- ▶ Strip wires on 7mm
- ▶ Pass the cable through a cable gland
- ▶ Connect a cable on the midpoint **COMMON (42)** of the terminal block
- ▶ Connect the second cable on the **WORK (41)** of the terminal block or on the **REST (43)** depending on the function to be performed
- ▶ Tighten the cable gland to seal.

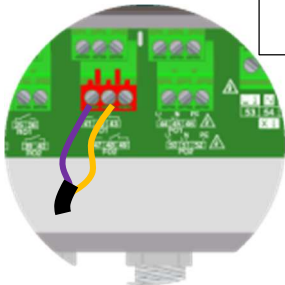

FO2

- ▶ Use a 2-wire cable with a section appropriate for the voltage and current.
- ▶ Remove the protective sheath
- ▶ Strip wires on 7mm
- ▶ Pass the cable through a cable gland
- ▶ Connect a cable on the midpoint **COMMUN (48)** of the terminal block
- ▶ Connect the second cable on the **WORK (47)** of the terminal block or on the **REST (49)** depending on the function to be performed
- ▶ Tighten the cable gland to seal.

12) Electronic relay outputs connections (RO1 et RO2)

The electronics relay outputs are mainly dedicated to controlling the dosing pumps in impulse mode. They can also serve as alarm relays or be controlled in timer mode according to your needs.



These relays use electronics components to make contact, they are used to drive pumps by their impulse input or to control an external power relay.

These relays can switch a maximum voltage of **48 VAC** and a current of **50mA**.

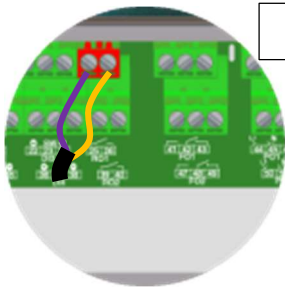
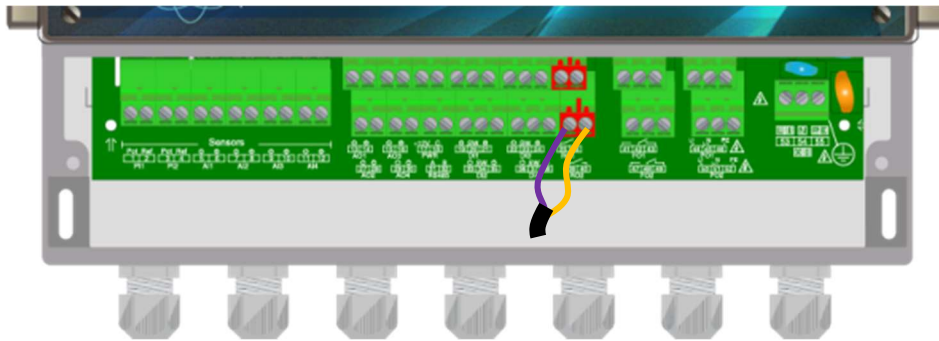

RO1

- ▶ Use a 2-wire cable with a section appropriate for the voltage and current
- ▶ Remove the protective sheath
- ▶ Strip wires on 7mm
- ▶ Pass the cable through a cable gland
- ▶ Connect a cable on the midpoint **COMMON (25)** of the terminal block
- ▶ Connect the second cable on the **WORK (26)** of the terminal block
- ▶ Tighten the cable gland to seal.

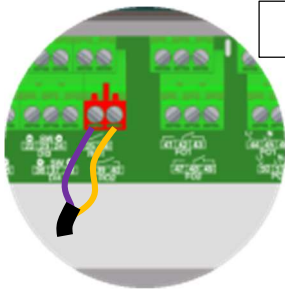

RO2

- ▶ Use a 2-wire cable with a section appropriate for the voltage and current
- ▶ Remove the protective sheath
- ▶ Strip wires on 7mm
- ▶ Pass the cable through a cable gland
- ▶ Connect a cable on the midpoint **COMMUN (39)** of the terminal block
- ▶ Connect the second cable on the **WORK (40)** of the terminal block
- ▶ Tighten the cable gland to seal.

13) 4...20mA outputs connections (AO1 to AO4)

4...20mA outputs are used to send information to a building management system or to control a dosing device via a 4...20mA signal. The analog outputs are generative and operate with an internal voltage of 12 VDC. The maximum load is 500Ω.

4...20mA outputs are fully configurable. You can assign any parameter (measured or calculated) in regulation or data transfer mode.

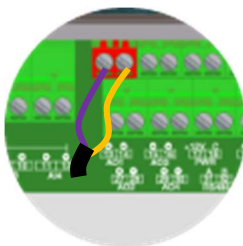
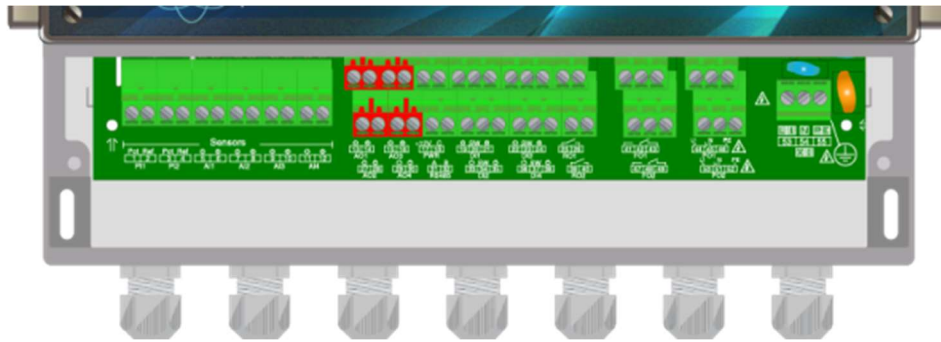
**AO1**

- ▶ Use a 2-wire cable
- ▶ Remove the protective sheath
- ▶ Strip wires on 7mm
- ▶ Pass the cable through a cable gland
- ▶ Connect the two wires of the 4...20mA loop **to + (13) and – (14)**
- ▶ Tighten the cable gland to seal

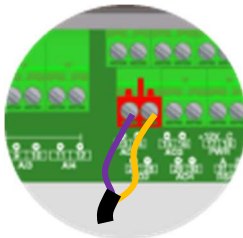
**AO2**

- ▶ Use a 2-wire cable
- ▶ Remove the protective sheath
- ▶ Strip wires on 7mm
- ▶ Pass the cable through a cable gland
- ▶ Connect the two wires of the 4...20mA loop **to + (27) and – (28)**
- ▶ Tighten the cable gland to seal.

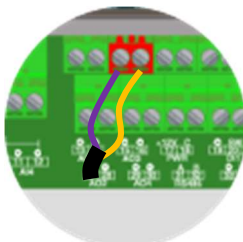
**AO3**

- ▶ Use a 2-wire cable
- ▶ Remove the protective sheath
- ▶ Strip wires on 7mm
- ▶ Pass the cable through a cable gland
- ▶ Connect the two wires of the 4...20mA loop **to + (15) and – (16)**
- ▶ Tighten the cable gland to seal.

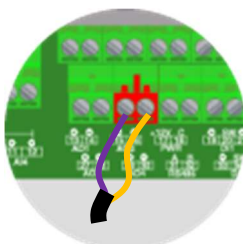
**AO4**

- ▶ Use a 2-wire cable
- ▶ Remove the protective sheath
- ▶ Strip wires on 7mm
- ▶ Pass the cable through a cable gland
- ▶ Connect the two wires of the 4...20mA loop **to + (29) and – (30)**
- ▶ Tighten the cable gland to seal.

14) Power supply output connection (PWR)

If necessary, it is possible to use chlorine or bromine sensors requiring an external power supply.

- ▶ Use a 2-wire cable.
- ▶ Pass the cable through a cable gland
- ▶ Connect the strand + of the alimentation on **+12V (17)**
- ▶ Connect the strand - of the alimentation on **C (18)**.
- ▶ Tighten the cable gland to seal.

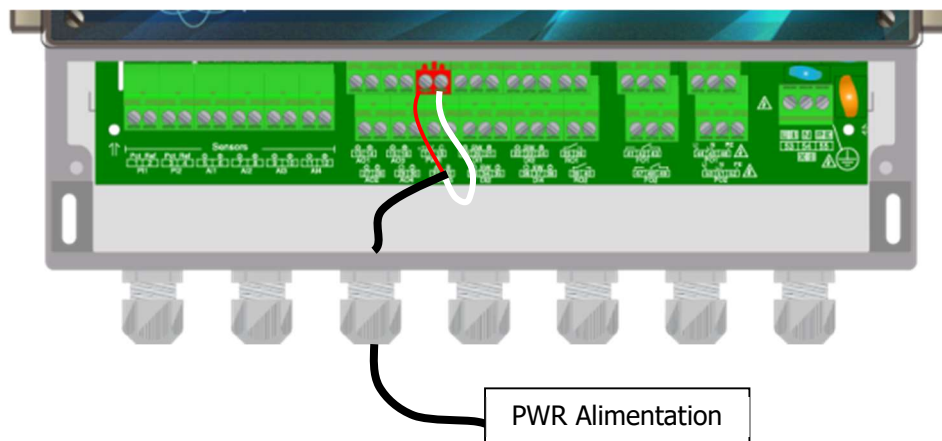

15) RS485 communication bus connections

SYCLOPE ODITouch® has a RS485 communication port to connect it to a computer equipped with a 485 port and a communication software to record the measurement values, alarms and different states of the device.

a) Connection to a USB port on a computer

- ▶ Use a 3-wire cable.
- ▶ Pass the cable through a cable gland.
- ▶ Wire AA' (n°3) of USB/485 converter to **RS485 (A) (31)**.
- ▶ Wire BB' (n°4) of USB/485 converter to **RS485 (B) (32)**.
- ▶ Wire C (n°5) of USB/485 converter to **PWR (C) (18)**
- ▶ Tighten the cable gland to seal.

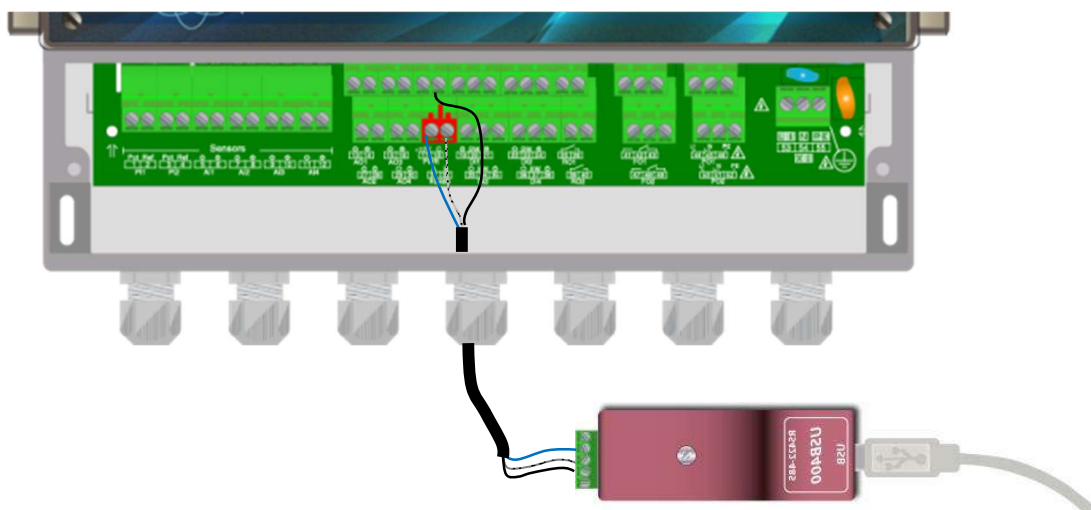

- Blue (Terminal n°3): AA' RS485
- White (Terminal n°4): BB' RS485
- Black (Terminal n°5): GND RS485



Configuration: All switches on "**ON**"

Contact us for more information about the product.



Respect the bus wiring.

A USB/RS485 converter is recommended to connect the SYCLOPE **ODITouch**® to a computer. Please refer to converter documentation to realize the connection.

Reference	Name
INF1021	Converter USB => 485



Devices can be chained respecting the order of cables (Parallel wiring).

b) Polarization and termination of the RS485 bus

The bus can be polarized from your device if necessary. To do this you must switch the two micro-switches (**Pol. RS+ (A)** and **Pol. RS-(B)**) of the electronic card in ON position.

If your device is the last on the line on the RS485 bus you can switch the **Term. RS** switch on ON to activate line termination.

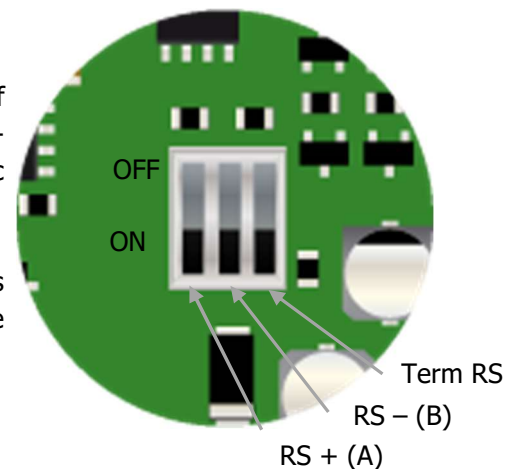

For security reasons, it's imperative to turn OFF the power of your device before opening the case to switch the micro-switches!



For more information about the RS485 converter configuration, see « DOC0461 Communication programming instructions ODITOUCHH ENG Rev1 ».

V. General use

SYCLOPE ODITouch® is intended for measurement, regulation and treatment of swimming pool water. The installation of **SYCLOPE ODITouch®** equipment is based on the principle of measurement and regulation on the pool filter circuit.



This type of installation is recommended in the event of a single pool or multiple pool, each with an independent filtration circuit.

- Water is taken by a specific sample after the filtration engine.
- The analysis chamber receives the water to be measured and transmits the parameters of the measurement probes to the **SYCLOPE ODITouch®** regulator.
- Depending on the set points set by the user, the **SYCLOPE ODITouch®** regulator sends injection orders of the product downstream of filtration to the dosing device.

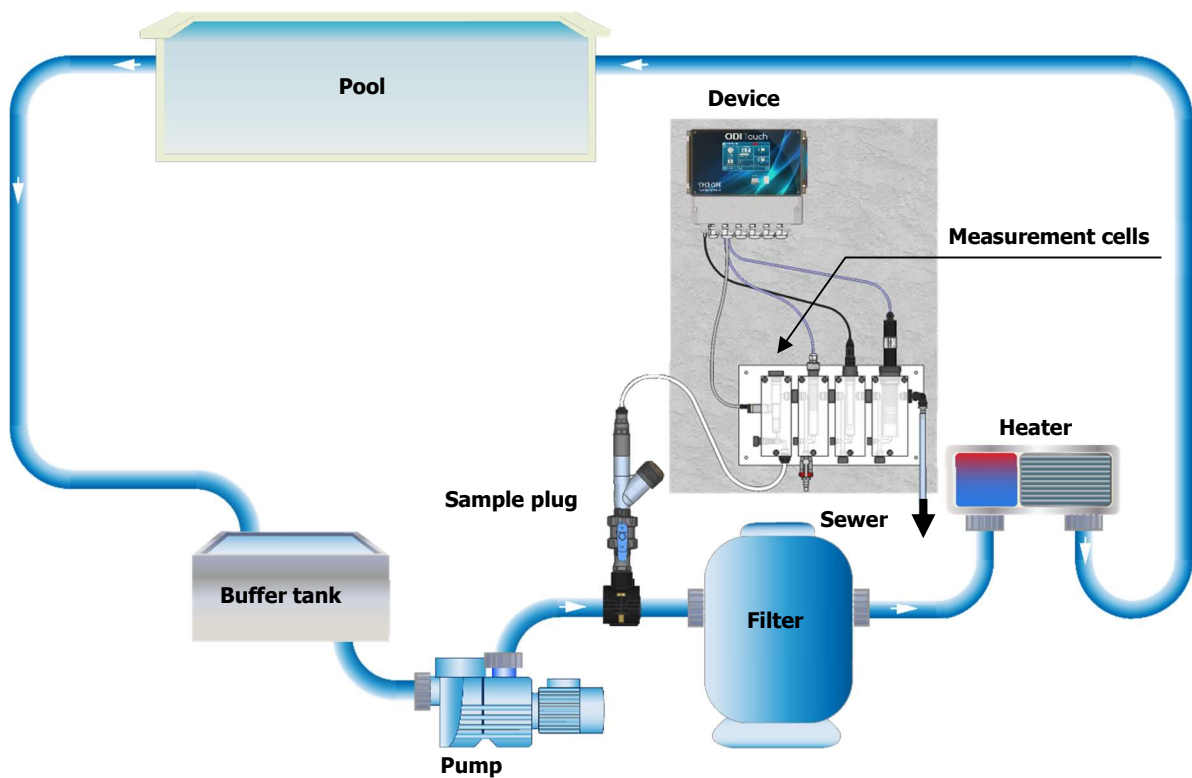

VI. Commissioning the SYCLOPE ODITouch®

You have just made the electrical connections and the connections of the various measurement and regulation devices. You are ready to realize the commissioning of your **SYCLOPE ODITouch®**.



- ▶ Switch ON the device.
- ▶ Check that everything is good, your control panel is switched ON and other elements of your installation haven't been disturbed.



SYCLOPE ODITouch® regulator doesn't automatically start the treatment and dosing of chemical product when you switch ON. Only the user can initiate the treatment after ensuring that the control unit is properly programmed according to his needs.



SYCLOPE ODITouch® regulator is fully configurable. When you switch ON, the predefined measured parameters are displayed and the regulation processes are inactive.



SYCLOPE ODITouch® regulator is delivered with standard programming. The user should modify this programming if it doesn't correspond with his needs. To modify the programming of your controller, please refer to the following chapter.

VII. Display mode and type

SYCLOPE ODITouch® regulator are fitted with a color touch screen graphic, all programming actions are realized with by pressing the screen. The touch screen is a resistive technology, you must press firmly on the screen to validate the action.



Make sure that your **SYCLOPE ODITouch®** controller is correctly programmed!
An excess of product, or even a mixture, can cause harmful actions on human health and the environment.

1) Main screen display

SYCLOPE ODITouch® regulator offers several modes and types of displays that will allow you to instantly have all information you need:

Display mode « small X6»

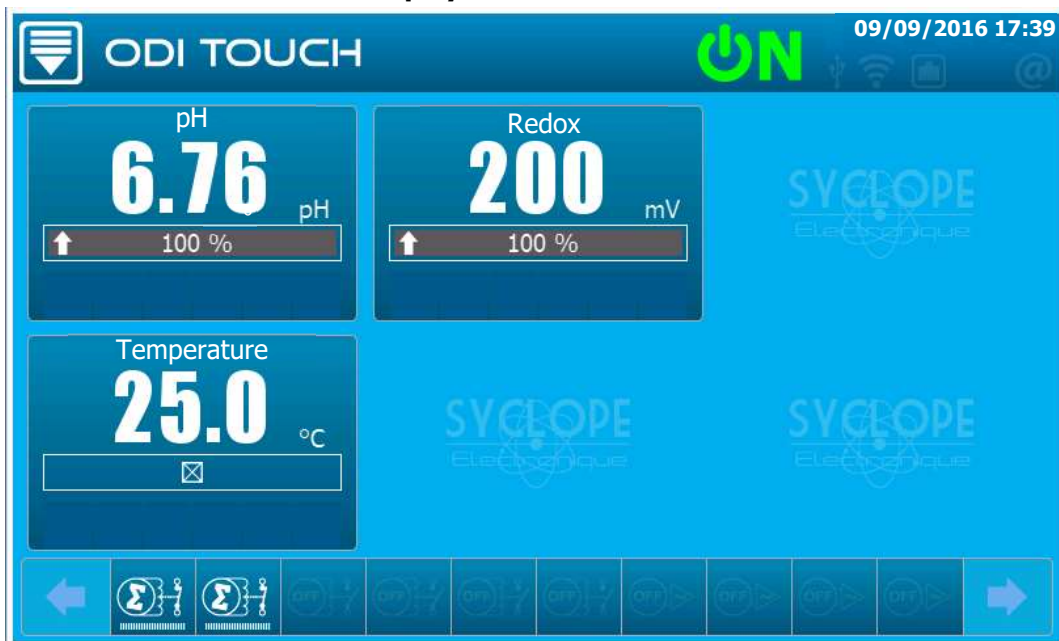

Display mode « large x3»

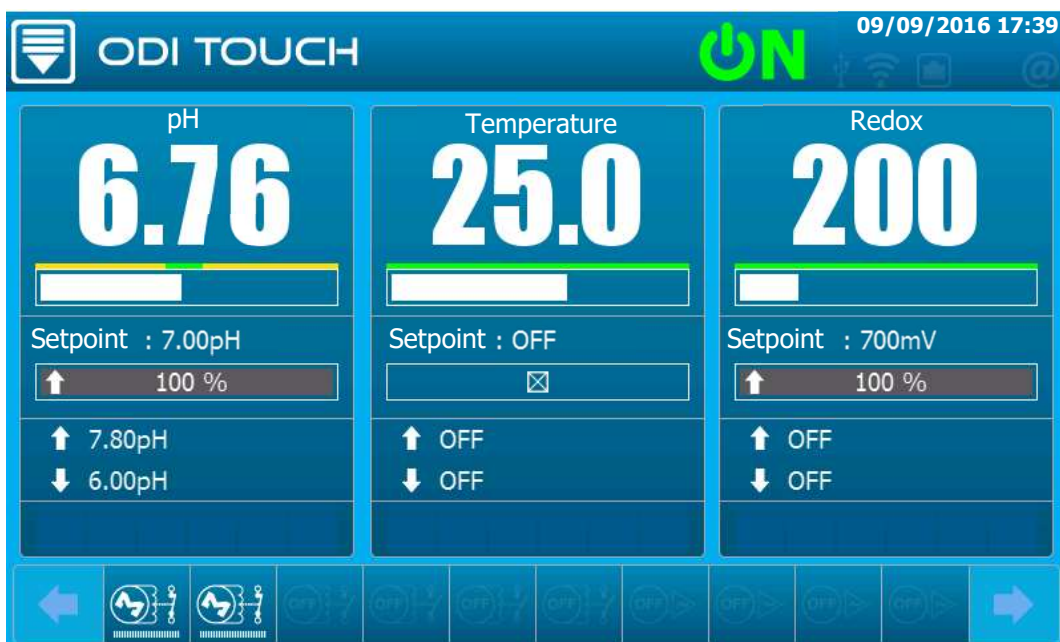

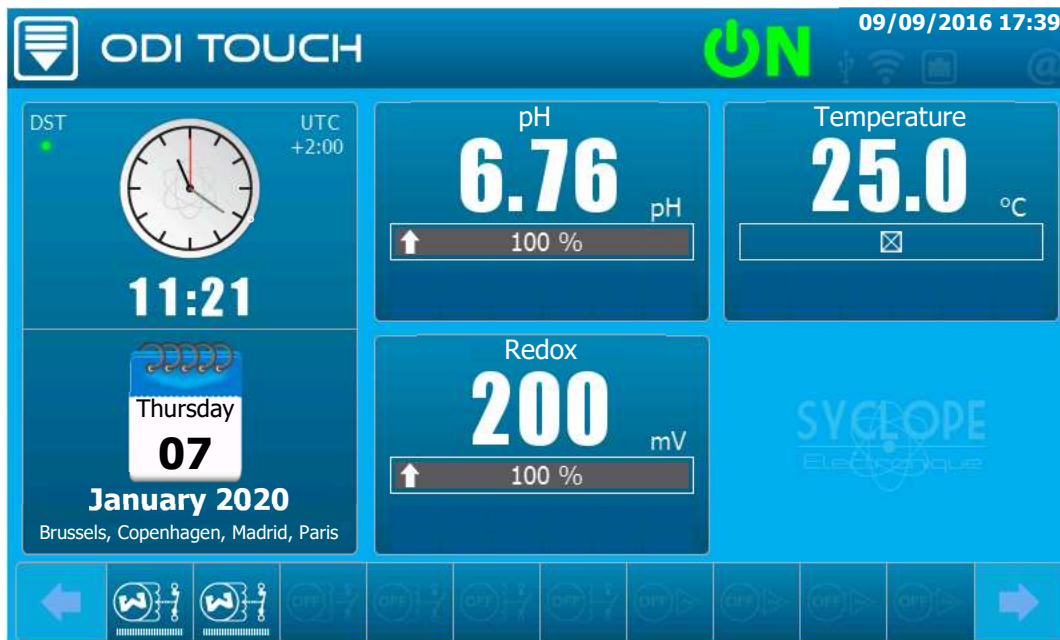

a) The upper banner

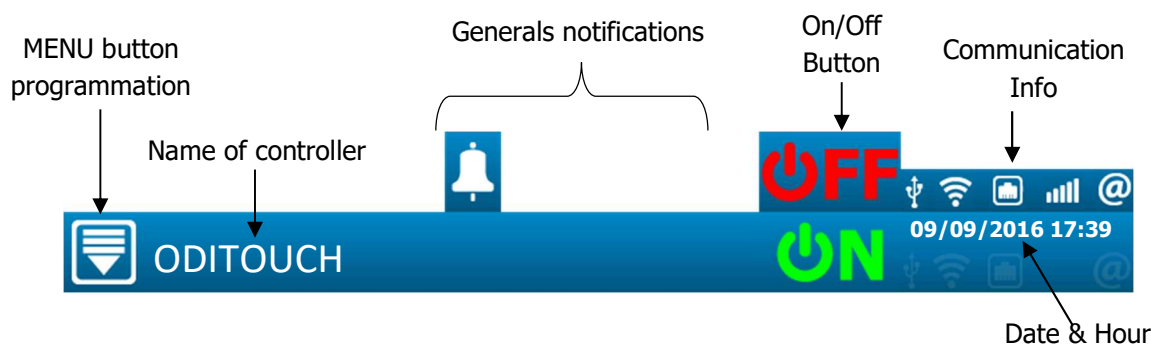

Menu button programming – Press to open the menu



For more information about this part, see « DOC0460 General programming instructions ODITOUCHH ENG Rev1 »

General notifications



Active alarm(s) *

* Depending on User configuration

On/Off button



Controller switched off – Press it to switch the controller ON

Controller switched on – Press it to switch the controller OFF





External touch button







Realize the option configured in « Menu User »; « General configuration »; « Button ». Start/Stop function set as standard.

See Doc0460 « General programming instructions ODITOUCHH » for more information.

Communication Info

     Press it to display communication information

(i) Communication Info
←

<div style="background-color: #0070C0; color: white; padding: 2px; border-radius: 5px; font-weight: bold;">8731</div>    	<div style="background-color: #4F81BD; color: white; padding: 2px; font-weight: bold;">Wifi</div> SSID: SYCLOPE-Etage State: Connected Signal: Good Unique ID 00:00:F3:EB:35:E5 Host Name ODT_W194120973 DHCP Activated OUI IP address 10.10.1.90 Mask 255.255.255.0 Gateway 10.10.1.200 DNS 1 10.10.1.100 DNS 2 10.10.1.200	<div style="background-color: #4F81BD; color: white; padding: 2px; font-weight: bold;">Eth.</div> <div style="background-color: #4F81BD; color: white; padding: 10px; text-align: center; font-weight: bold; font-size: 16px;">Not available</div>	<div style="background-color: #4F81BD; color: white; padding: 2px; font-weight: bold;">Socket</div> PIN: PIN OK State: Connected Signal: Average Network : F SFR APN : m2minternet
<div style="background-color: #4F81BD; color: white; padding: 2px; font-weight: bold;">ModBus</div> <div style="background-color: #4F81BD; color: white; padding: 2px; font-weight: bold; text-align: center;">RTU</div> Speed : 19200 Parity : WITHOUT Address : 1 <div style="background-color: #4F81BD; color: white; padding: 2px; font-weight: bold; text-align: center;">TCP</div> Port : 502 Peripheral : WIFI	<div style="background-color: #4F81BD; color: white; padding: 2px; font-weight: bold;">WebServer</div> <div style="background-color: #4F81BD; color: white; padding: 10px; text-align: center; font-weight: bold; font-size: 16px;">Not available</div>	<div style="background-color: #4F81BD; color: white; padding: 2px; font-weight: bold;">Mysyclope</div> Server : www.syclope.com Port : 18882 Conf. : Connected via WIFI <div style="background-color: #4F81BD; color: white; padding: 2px; font-weight: bold; text-align: center;">Connected</div>	



For more information about this part, see « DOC0460 General programming instructions ODITOUCHH ENG Rev1 »

Notifications

Inactive



USB connection
 Wifi connection
 Ethernet connection
 GSM connection
 MySyclope connection

Active



No connections to MySyclope server (See. *DOC0461 - Communication programming instructions ODITOUCHH* for more information)



USB key detected but not compatible, not readable (USB key must be formatted in FAT32)



Connections to WIFI impossible (See. *DOC0461 - Communication programming instructions ODITOUCHH* for more information)

b) Lower banner

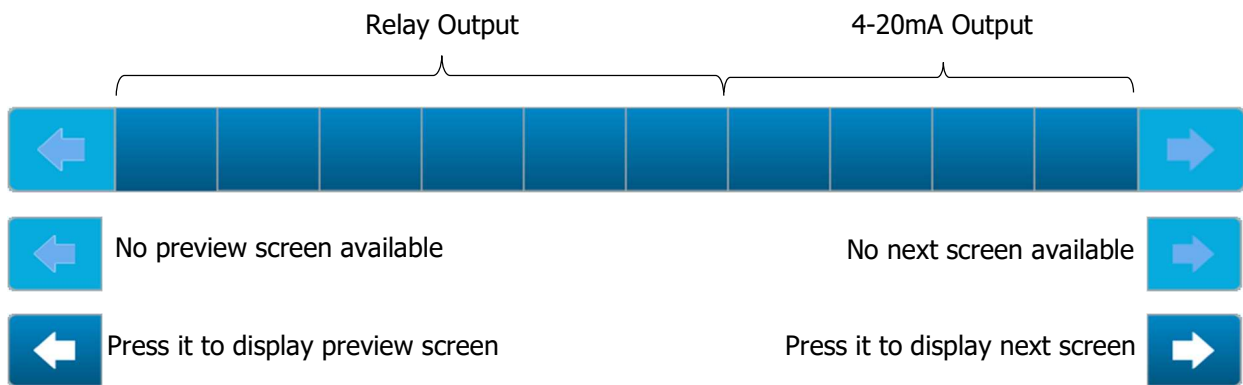

Movement arrows are accessible if several display screens are programmed.

Outputs

- | | |
|---|--------------------------------|
| Relay output non-Used | 4-20mA Output Non Used |
| Relay output in Dosing mode* | 4-20mA Output in Dosing mode * |
| Relay output on Timer | 4-20mA Output in Transfer mode |
| Relay output on Alarm | |
| Relay output on Bottom level tank | |
| Relay output on Water circulation | |
| Relay output on Contact | |
| Relay output on Flowrate | |
| Relay output on ON/OFF Controller or Parameters | |

*- Icons are animated when dosing mode is active.
 - The rotation of the dosing symbol depends on the dosing power.
 - The visual state of the relay is displayed closed when it is active.

➤ **Relay output in Dosing mode**

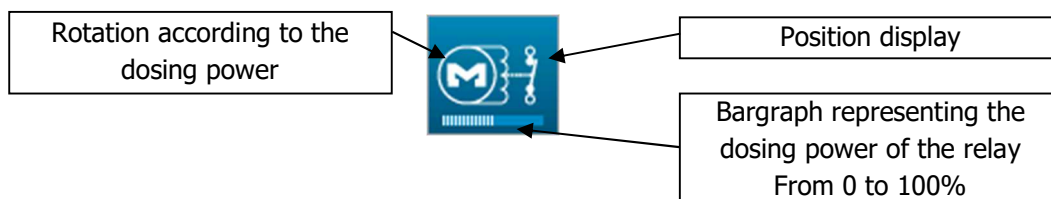

➤ **Protective fuse out of order**



The self-powered PO1 and PO2 relays have TR5 fuse protection. When a fuse is destroyed a specific Icon (see figure opposite) appears on the output concerned.

➤ **4...20mA Output in Dosing mod**

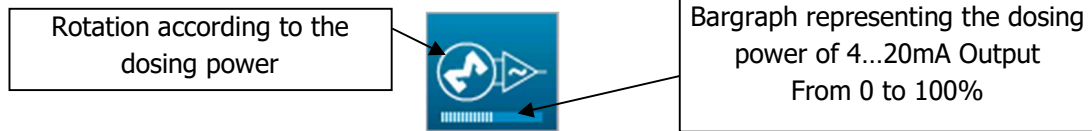

➤ **4...20mA Output en Transfer mode**

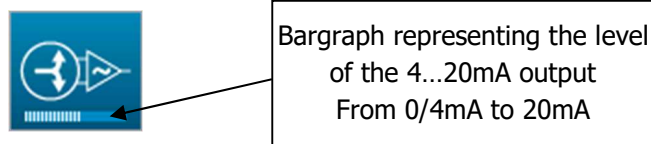

Output information

When you click on one of the outputs, you will display information on the programming and state of the selected output.

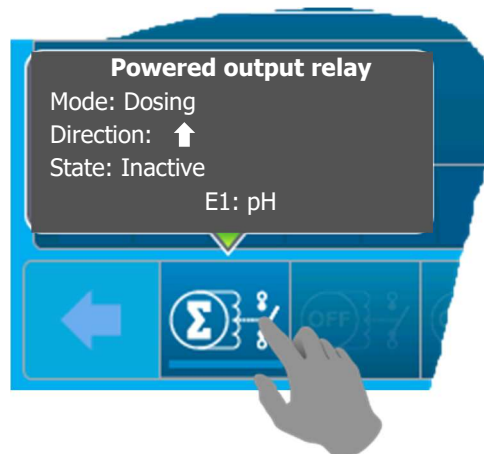

Informations displayed may vary depending on the configuration of output.

c) Display details of the "Small x6" channels

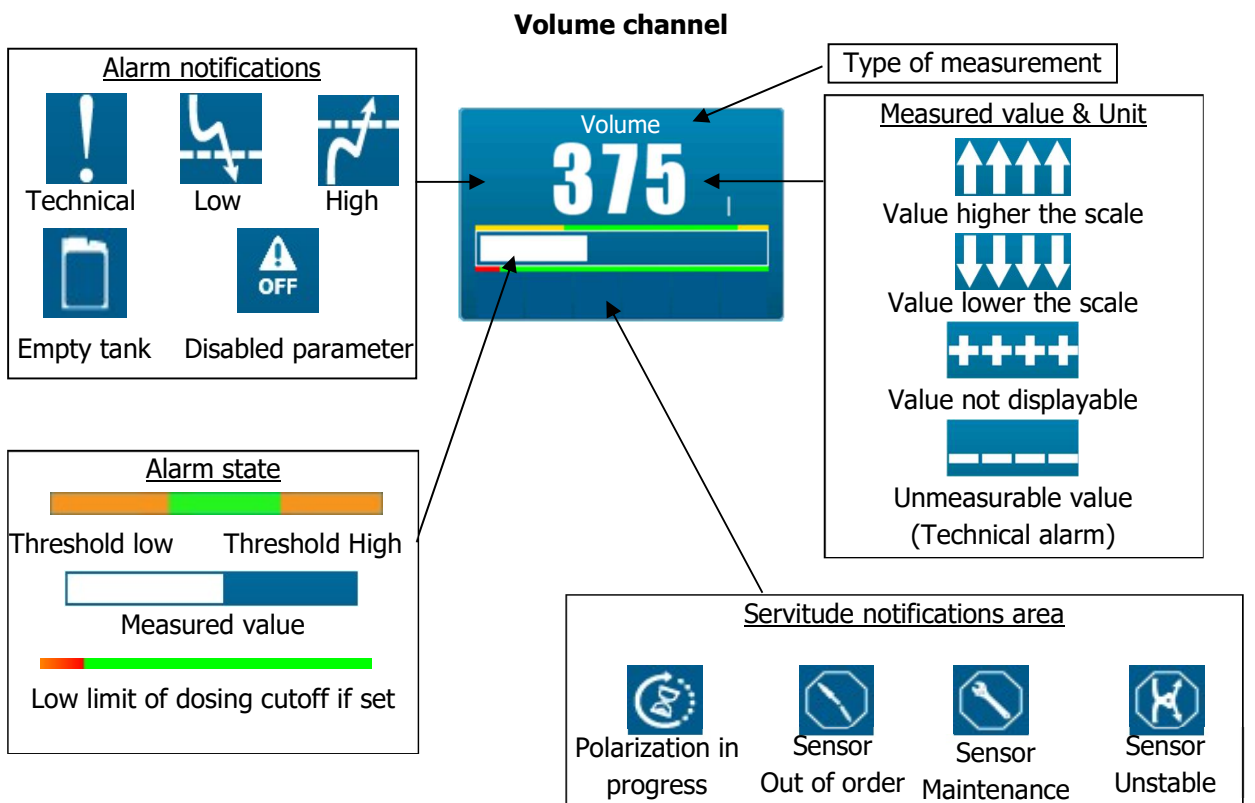
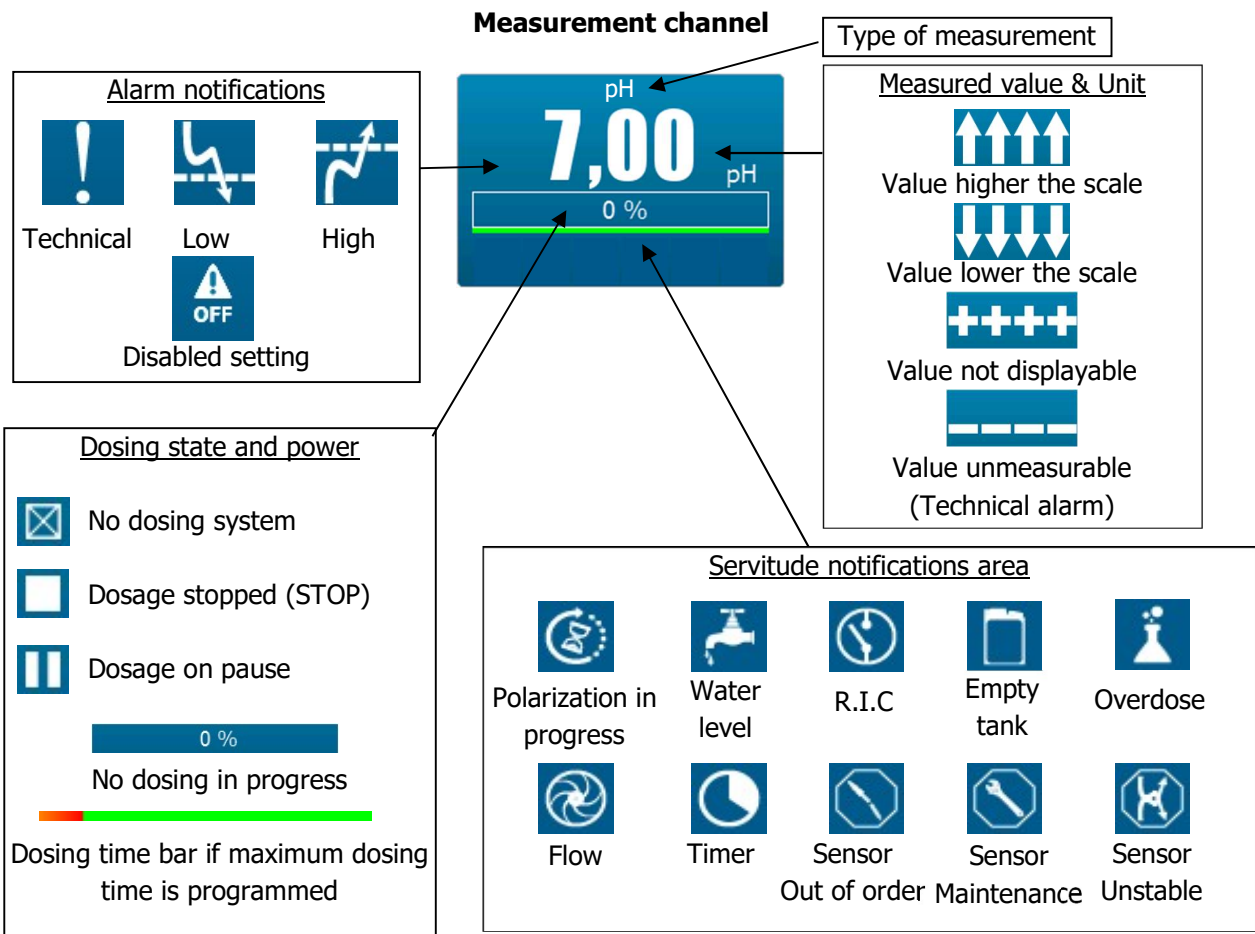

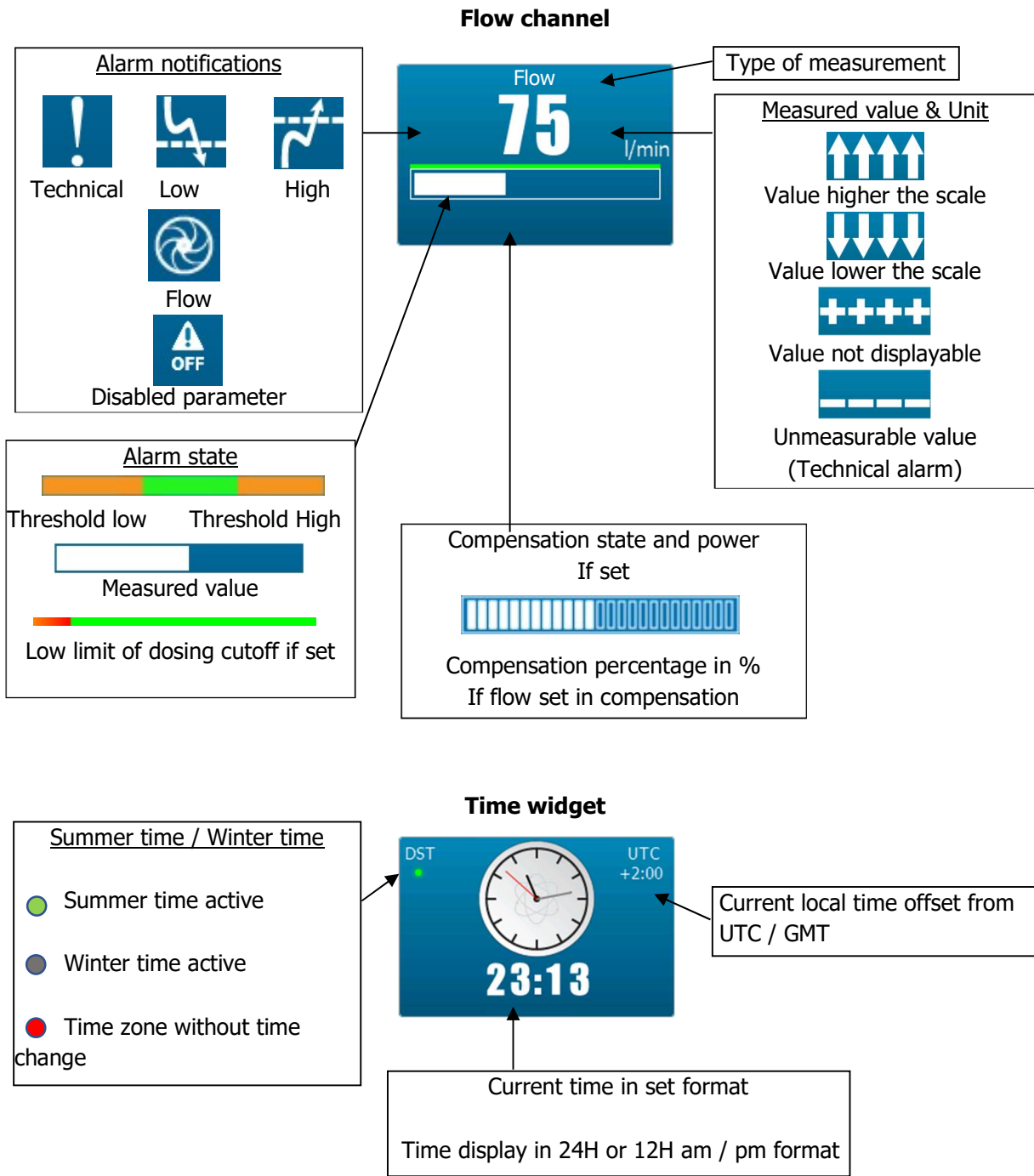

d) Display details of the "Large x3" channels

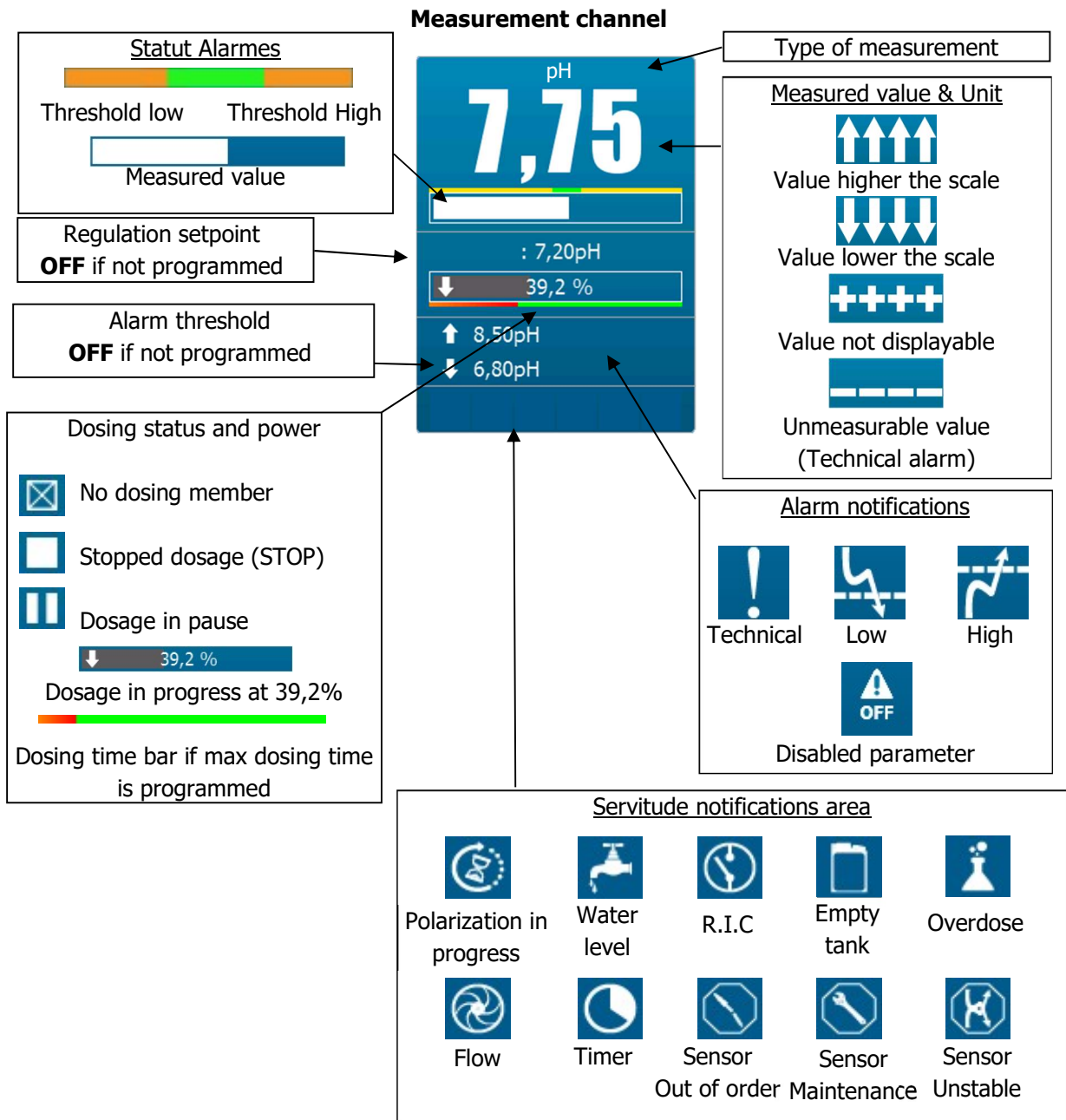

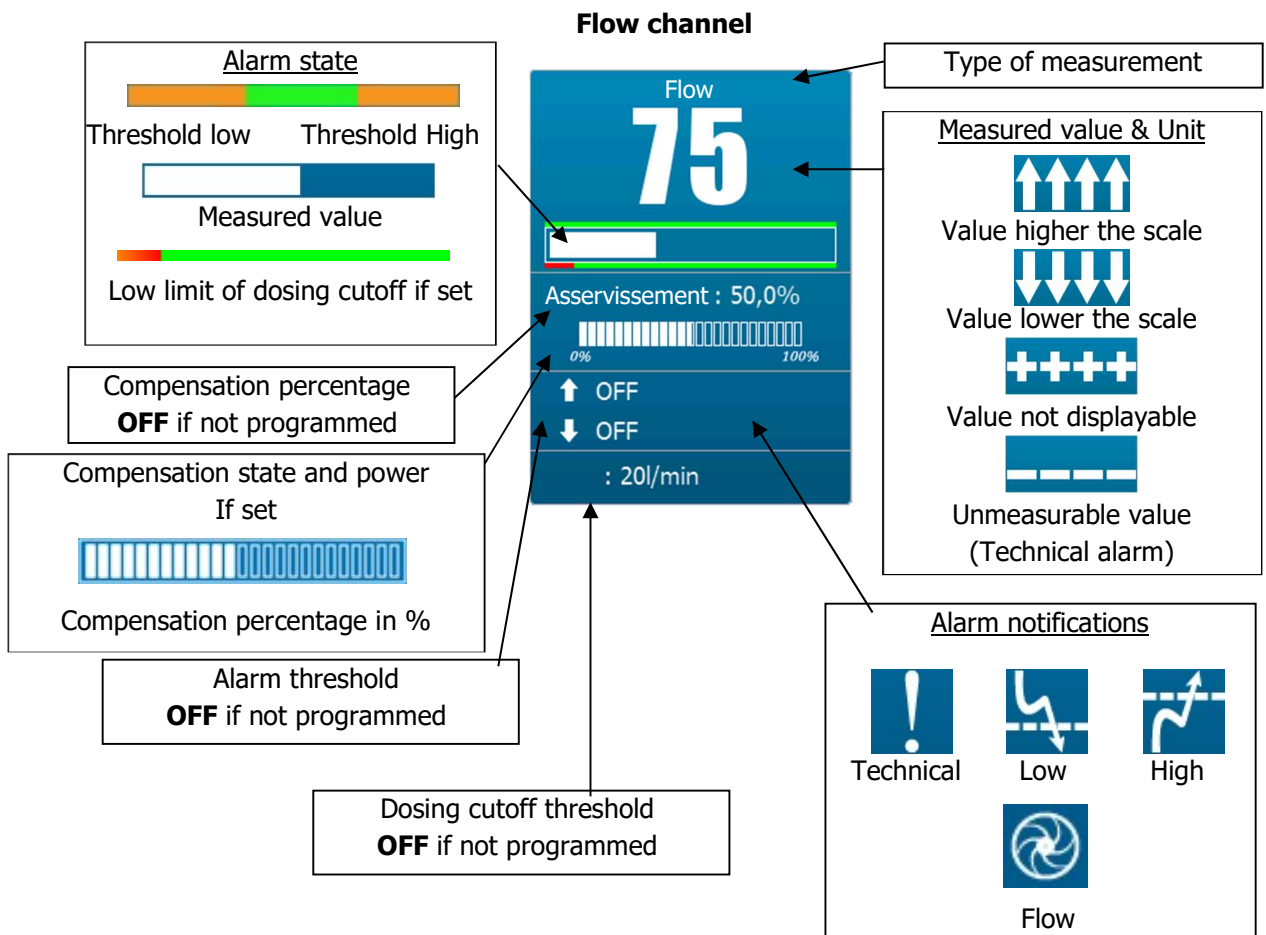
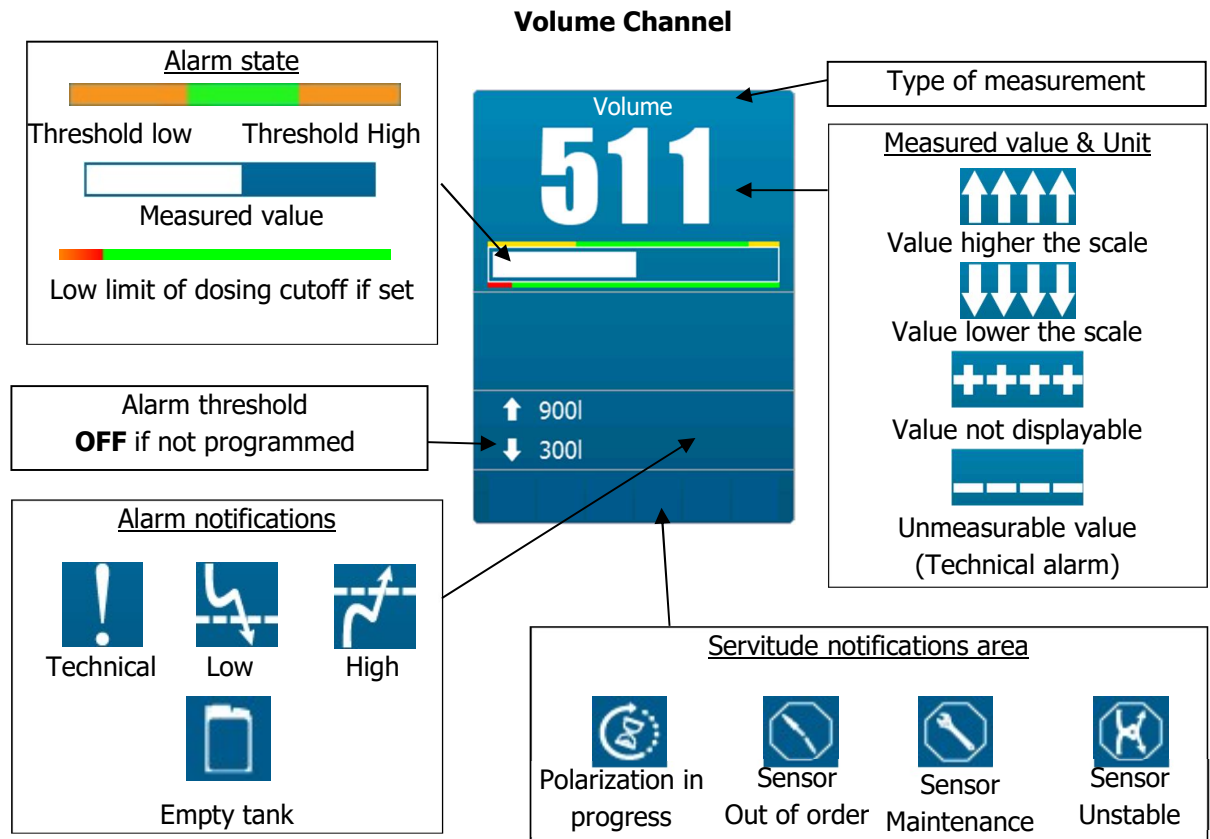

Widget Date/Hour

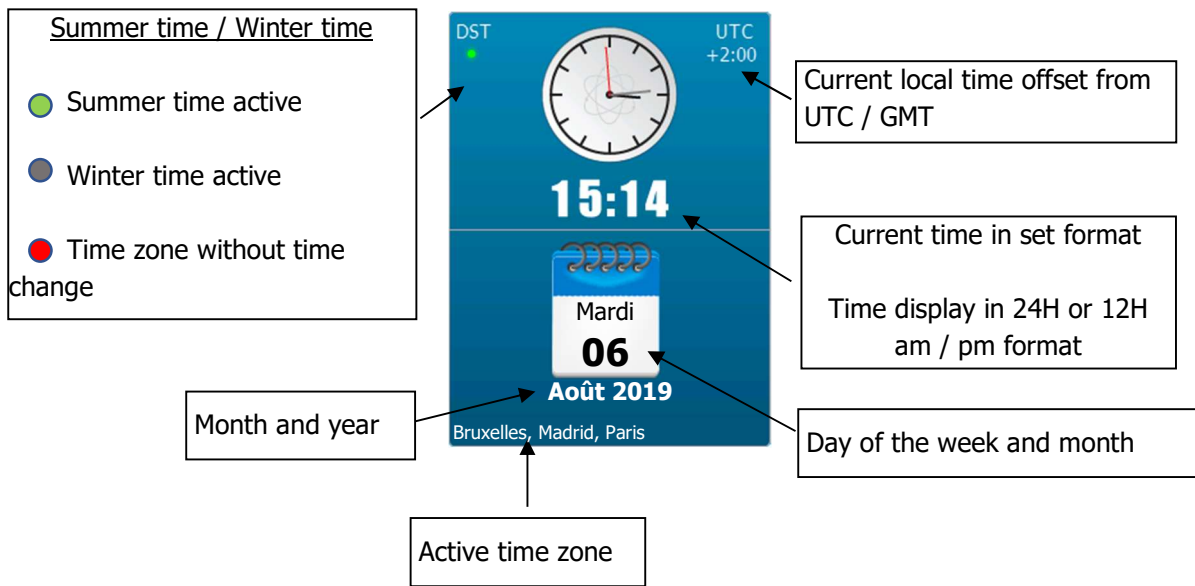

2) "Detailed" display of a channel

To open the detailed display screen, press on a  sticker of the main screen.

The detailed display for 'E01: pH' includes:

- Current Value:** 6.76 pH with a 100% progress bar.
- Main sensor information:** Type: Potentiometric, Scale: 0,00...14,00 pH, Raw signal: PI1 14 mV.
- Dosing:** FO1 - ↓ - PFM - P.I.D. Set point: 7.00 pH, Time Max.: OFF min.
- Alarm threshold:** High: OFF pH, Low: 6.00 pH. Stop dosing:
- Calibration:** LAST CALIBRATION 16/04/2020 - 10:27 Erasure. Offset: 0mV, Slope: 100%. Calibrate button.
- Controls:** Cancel, Erase, Disable the parameter, History.



Display of the sticker in small thumbnail. Refer to « Display details of the "Small x6" channels" of main screen for more information



If the 'User' code is activated, a window asking you to enter the user code will open when you want to change a parameter from the detailed view. The code remains active as long as you don't exit the detailed view.

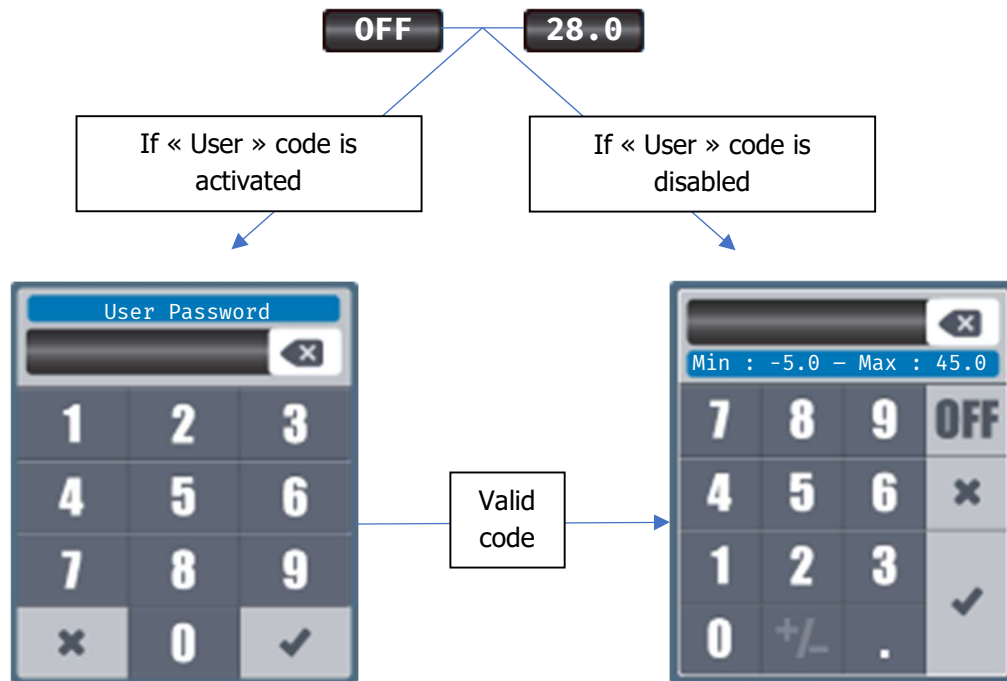

► Enter the 4-digit code then confirm.

► Enter the new instruction then confirm

► « Cancel » button

This button cancels the current polarization delay. If the hourglass icon representing the time delay is flicking, the function is active.



Button disabled, function unavailable



Button active, function available

► « Erase » button

This button clears the overdose memorization and reactivates the dosage. If the overdose icon is displayed, the function is active.

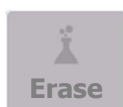

Button disabled, function unavailable



Button active, function available

➤ « **Disable the parameter** » & « **Activate the parametre** » button

This button allows you to stop managing the parameters. Alarms, dosing, relays and 4...20mA outputs associated with this parameters will be stopped.



➤ « **History** » button



This button displays the channel history. (See §VII.3 Graphical channel history display)

➤ « **Main sensor information** » area

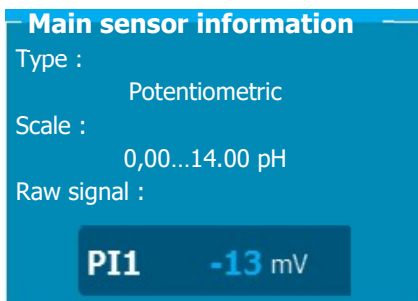

Type : Type of the main sensor

Scale : Scale of the sensor

Raw signal : Input measurement signal

➤ « **Dosing** » area

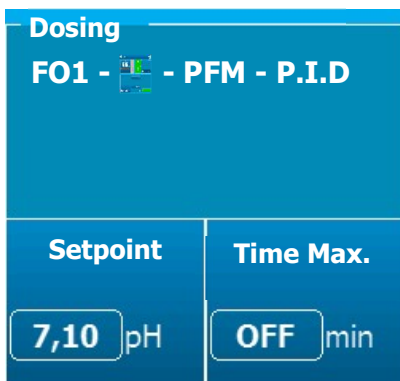

List of dosing units assigned to the parameter :

FO1 : Output number

: Dosing direction

PFM : Operating mode of the system

P.I.D : Dosage calculating mode

Setpoint button : Used to change the parameter setpoint

Time Max. button : Used to change the maximum dosing time

○ Setpoint button



○ Time Max. button



➤ « Alarm threshold » area

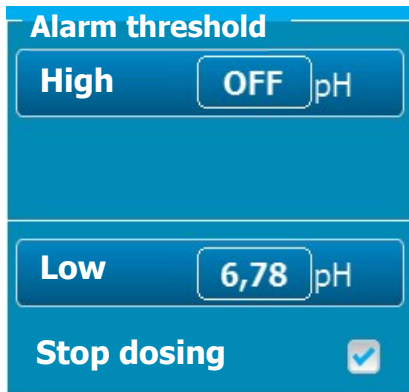

List of alarm thresholds.

High button : Used to change the high alarm threshold

Low button : Used to change the low alarm threshold

Stop dosing : Allows you to choose if the dosing stops if the concerned threshold is exceeded. Here it is activated.



The box checked « Stop dosing » is only visible if the alarm threshold is active.

- « High » alarm button



- « Low » alarm button



➤ « Controlling » area in the case of an input flowrate

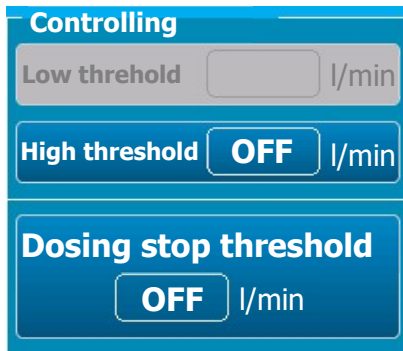

List of controlling threshold

Low threshold button : Used to change the low alarm threshold

High threshold button : Used to change the high alarm threshold

Dosing stop threshold button : Used to change the dosing stop threshold.

- « Low threshold » button



- « High threshold » button



- « Dosing stop threshold » button



➤ « **Controlling** » area in the case of an input Volume

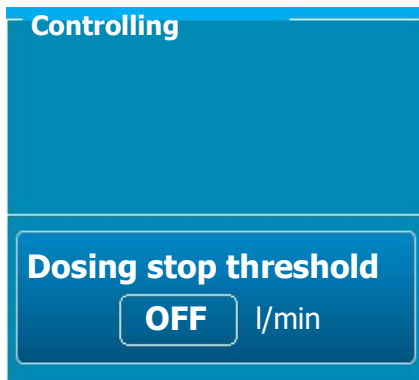

List of controlling threshold

Dosing stop threshold button : Used to change the dosing stop threshold.

- « Dosing stop threshold » button



➤ « **Calibration** » area

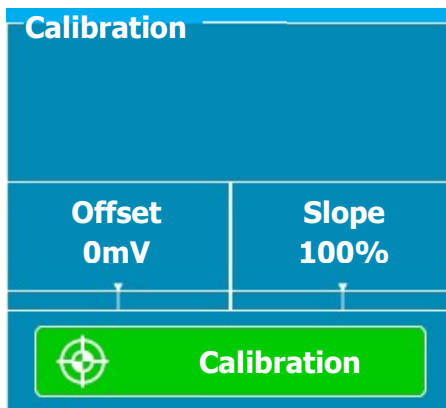

List of the different calibration parameters associated with the input.

Offset : Indicates the offset value has been set

Slope : Indicates the percentage of slope has been set

Calibration button : Used to change the calibration value.

- Offset (Example pH) :



⇒ Display the state of the sensor offset calibration

⇒ The more the bargraph becomes red, the more the calibration limit is reached. This information can be a sign of sensor aging.

⇒ The offset is expressed in the unit of the physical sensor input. The min. and max. values are different according to the sensors.

○ Slope (Example pH) :

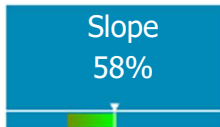

- ⇒ Display the state of the sensor slope calibration
- ⇒ The more the bargraph becomes red, the more the calibration limit is reached. This information can be a sign of sensor aging.
- ⇒ The slope is expressed in percentage and may vary from 0% to 200%, 100% represents a slope without calibration.

○ « Calibration » button



If an incorrect or out-of-scale value is entered, the « Min : 0 – Max : 14.00 » is displayed in red when you press « Enter »



If the value entered is correct, a « Calibration performed with success » window appears.

3) Graphical channel history display

Press  to display the following screen:

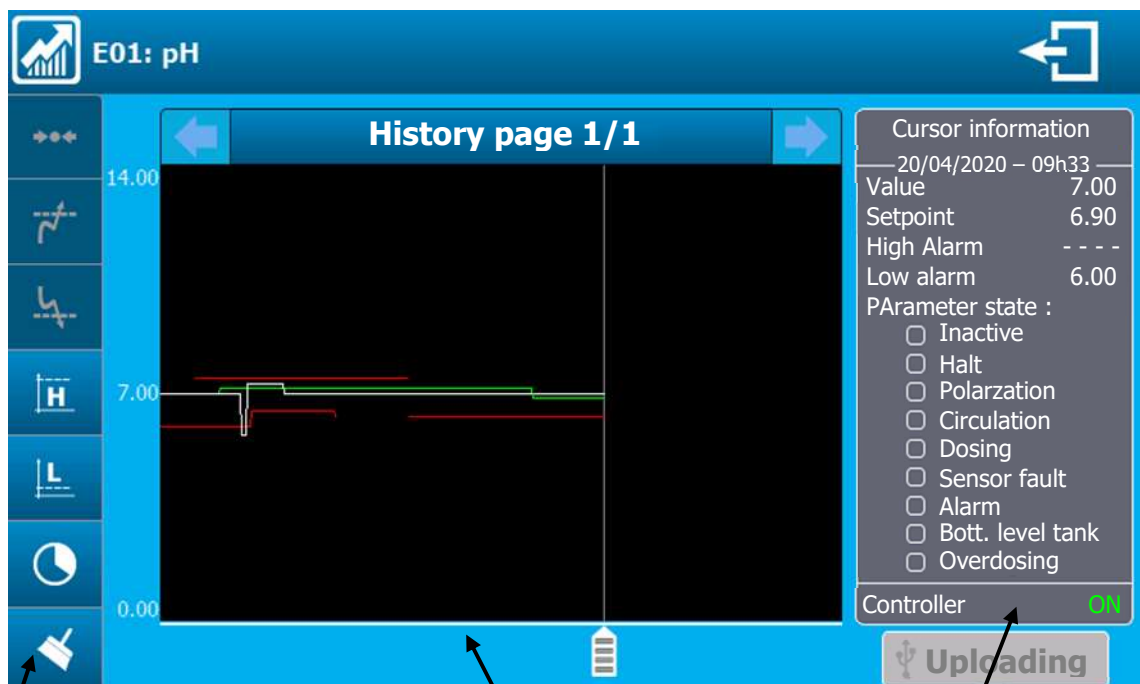

Lateral banner

Recording screen

Cursor information

➤ **Recording screen**

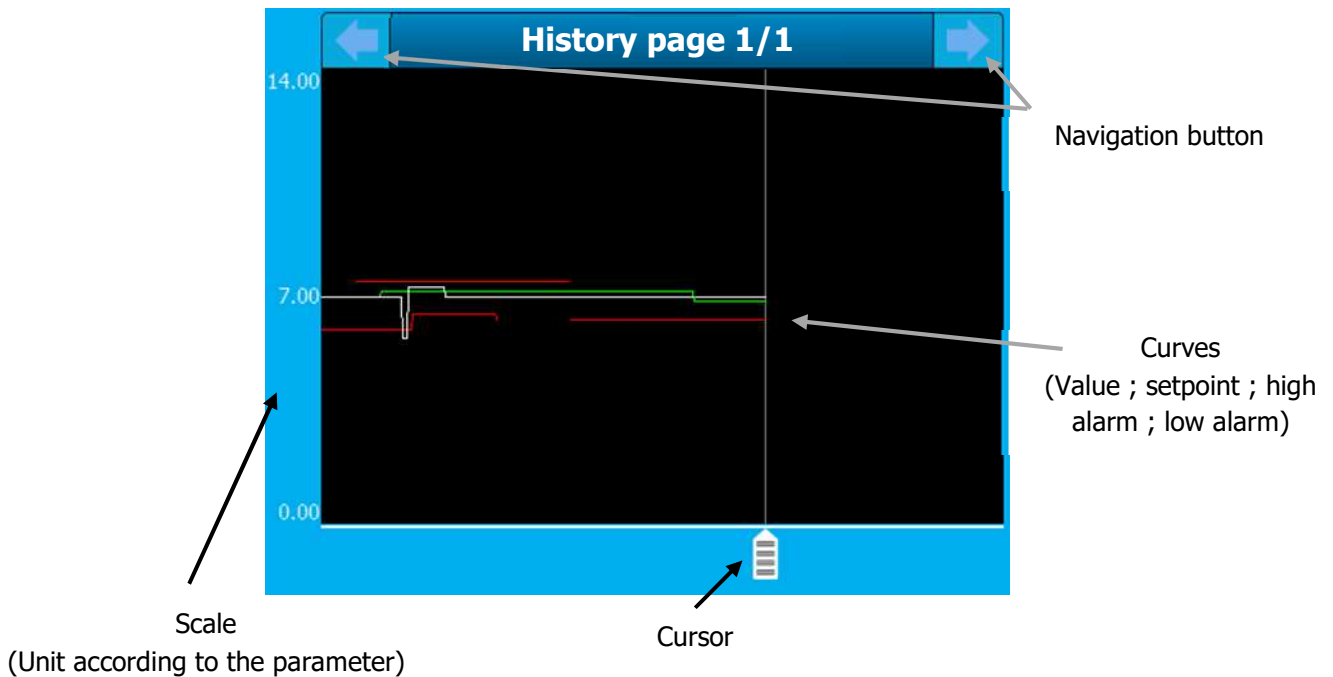

- Scale: Represents the values of the curves that are displayed. A "Zoom" can be achieved by decreasing the high scale and increasing the low scale (See "Lateral banner" for how to modify scale)
- Cursor: Allow you to view the different information (Value, setpoint, dosage status...) over time by moving the cursor from left to right.
- Curves:
 - Value in white
 - Setpoint in green
 - High alarm and low alarm in red
- Navigation button: The "Arrow" buttons allow you to move from one page to another (Active if the number of pages is greater than 1)

➤ **Lateral banner**

	<input type="checkbox"/>	Enable/Disable display of the setpoint curve (Green curve)
	<input type="checkbox"/>	Enable/Disable display of the High alarm curve (Red curve)
	<input type="checkbox"/>	Enable/Disable display of the Low alarm curve (Red curve)

The Enable/Disable buttons for displaying Setpoint, High alarm and Low alarm can be greyed out if the parameter is not activated.



Press on it to open the numeric keyboard which allow you to modify the value of the High Scale (Min. and Max. different according to the type of measurement).



Press on it to open the numeric keyboard which allow you to modify the value of the Low Scale (Min. and Max. different according to the type of measurement).



Press on it to open the numeric keyboard which allow you to modify the duration of the recording interval (Min : 0 ; Max : 255). (0 is equivalent to OFF and therefore stop recording)



Press on it to clear history. The window bellow will open asking you to confirm or not the deletion of the history.



➤ Cursor information

This part contains all the information (value, alarms, states...) of the channel at a given time (moment which can be modified by moving the cursor from left to right).

Cursor information

20/04/2020 – 09:33

Value	7.00
Setpoint	6.90
High alarm	- - - -
Low alarm	6.30

Parameter state:

- Inactive
- Halt
- Polarization
- Circulation
- Dosing
- Sensor fault
- Alarm
- Bott. Level tank
- Overdosing

Controller ON

Date and time according to the cursor

Value: Value of the parameter

Setpoint: Regulation instruction (- - - - => Instruction disabled)

High alarm: High setting alarm (- - - - => Alarm disabled)

Low alarm: Low setting alarm (- - - - => Alarm disabled)

Inactive: Status of the regulator (: Active ; : Inactive)

Halt: State of the channel (: Operating ; : Pause)

Polarization: Polarization of the sensor (: Polarized sensor ; : Polarization in progress)

Circulation: State of water flow (:Active flow ; :No flow)

Dosing: State of the dosage (: No dosage ; : Rising dosage in progress ; : Falling dosage in progress)

Sensor fault: State of the sensor (: Sensor OK ; : Sensor fault)

Alarm: State of alarms (: No alarm ; : Active alarm)

Bottom level tank: State of the tank (: Full tank ; : Empty tank)

Overdosing: State of the overdosage (: Normal state ; : Overdosage)

Controller : State of the controller (ON :Controller in operating ; PAUSE : Controller on pause ; OFF : Controller off)

➤ **Uploading button**



The "Uploading" button allows to export the history on a USB stick.

Pressing the button will perform the export and open a window indicating the success of the export.

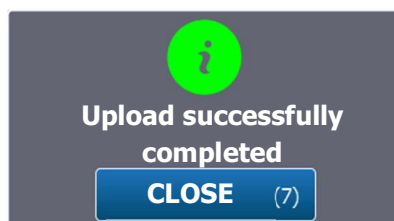

To make the "Uploading" button active you must insert a USB stick. Otherwise it remains greyed and inactive.

VIII. Input mode

The **SYCLOPE ODITOUCH**® controller has a 5" touch screen. All orders are made by pressing areas of the screen provided.

1) Installer or User code entry screen

This screen will appear if a user or installer code is programmed.

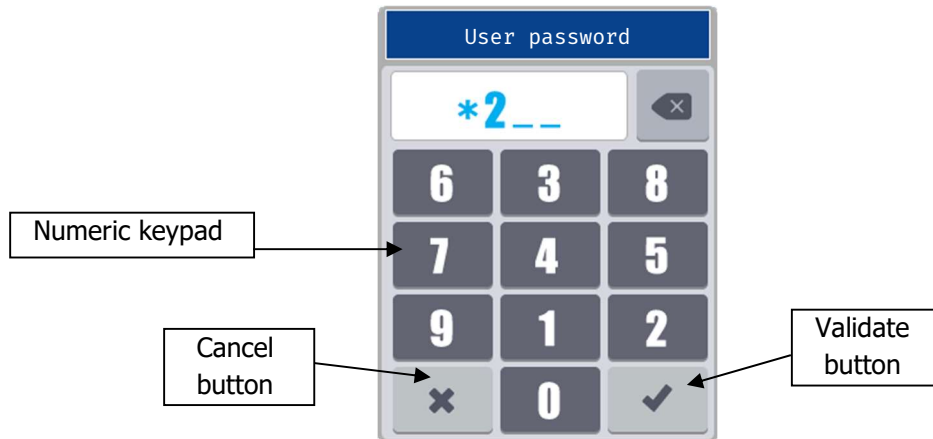

For more security, numbers are displayed randomly each time this screen appears.

2) Numerical value entry screen

This screen will appear when entering a numeric value.

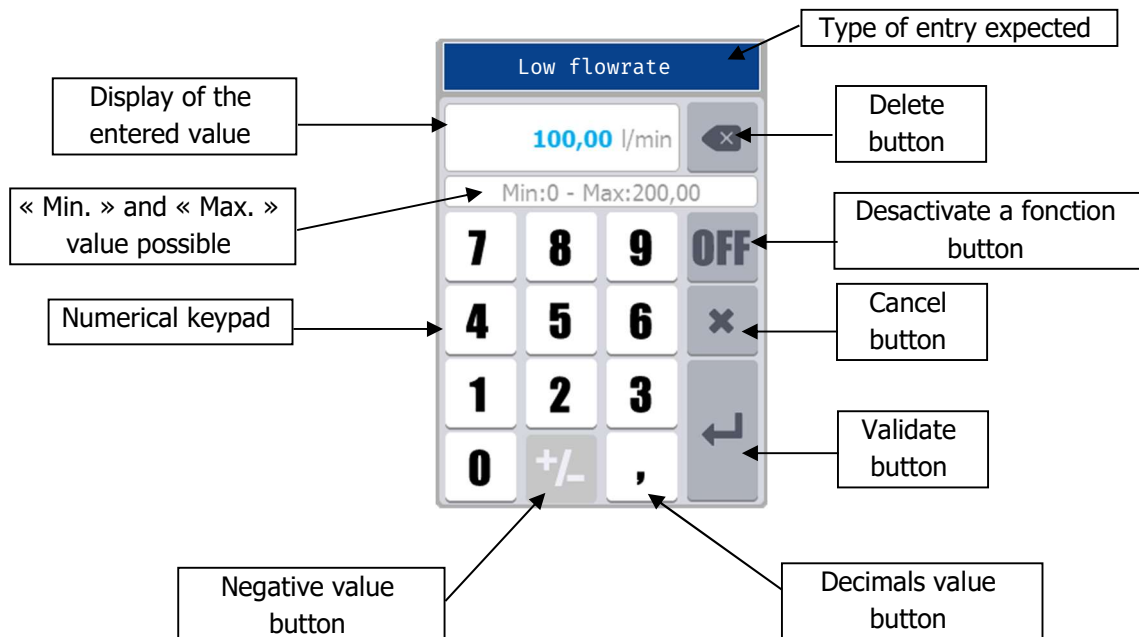

Depending on the values to be entered, some keys may be grayed out because they are not used for the expected value.



The decimal symbol changes automatically according to the language.



If an incorrect or out-of-scale value is entered, the « Min : 0 – Max : 14.00 » is displayed in red when you press « Enter »



« OFF » button used to deactivate a value, exemple, deactivate an alarm threshold.

3) Alphanumeric keyboard

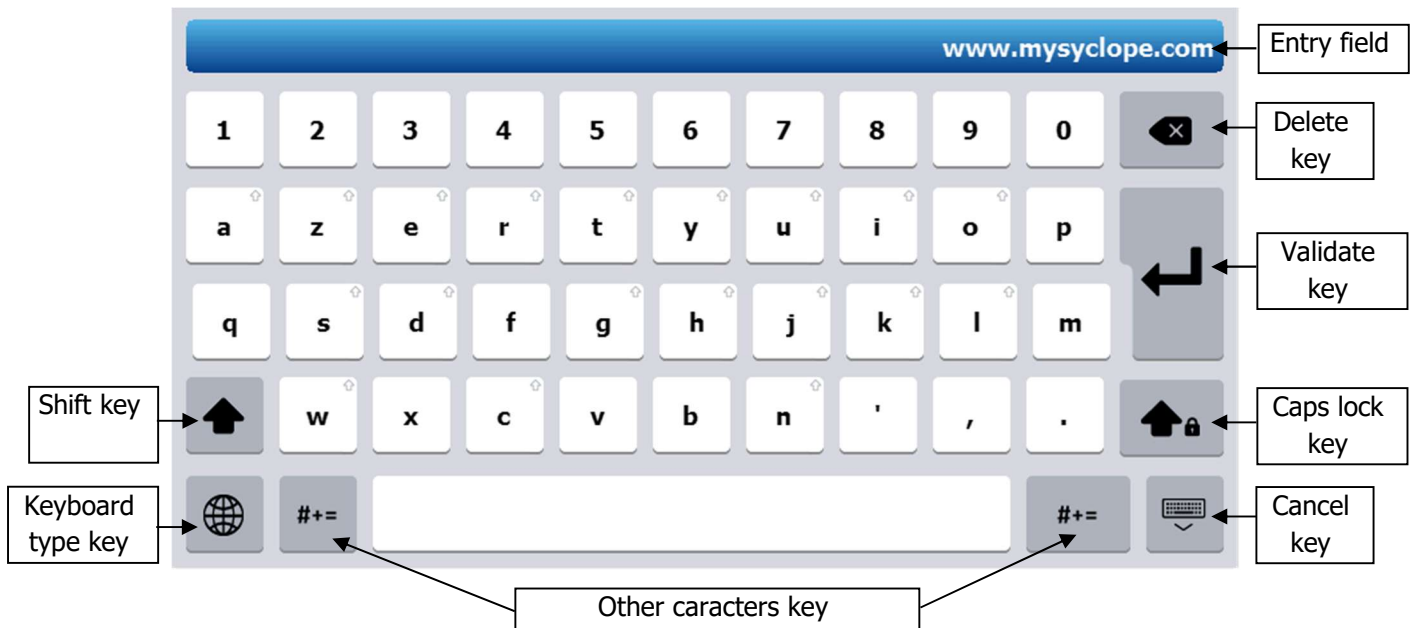

a) « Shift » key

This key switch the keyboard from lowercase to uppercase and vide versa. When this key is pressed, it will automatically switch again after pressing an alphanumeric key.



Key released and inactive => press



Key pressed and active



Key not available ins this keyboard configuration

b) « Caps lock » key

This key switch the keyboard from lowercase to uppercase and keep it in uppercase. In this position the "Shift" key allows a temporary toggle from capital to small.



Key released and inactive => press



Key pressed and active



Key not available ins this keyboard configuration

c) « Keyboard type » key

This key allows you to change keyboard type. Each language has its corresponding keyboard (AZERTY, QWERTY, QUERTZ...). It's also possible to display the keyboards of the other language by pressing the key below.



Key released => press change keyboard type.

d) « Other characters » key

This key switch the keyboard to symbols or other characters not available in the lower and upper case.



Key released lowercase uppercase mode active.

=> Press



Key pressed other character mode active.

e) « Back » key



This key deletes the last character entered.
Press to delete the last character.

f) « Enter » key



This key closes the keyboard while saving the changes.

Tap to close and save.

g) « Close » key



This key closes the keyboard without saving the changes.
Press to close without saving.

h) Special case of access to accented character keys.

To access accented characters, press and hold the corresponding unaccented character for more than 2 seconds to display the list of available characters. This list close automatically when any character is pressed.

Example : Press the lowercase "a" key for 2 seconds



 All keys with this symbol at the top right have additional characters accessible by pressing them for 2 seconds.

4) Main input elements

a) Opening a selection list

Open a list  Press  to open a list.



b) Multi selection button

Check box  Press  to change the state Inactive/Active 



Multi selection version, press the item to select

State box **NO**  Press  to cahnge the state NO / NC 

Direction box **NEGATIF**  Press  to change the direction 

c) Unique selection button

Selection box  Press  to active state select 

d) Input button

Numeric entry **180** Press  to open numerical keyboard.

e) Action button



Save a configuration



Delete a configuration



Back button, back to the previous screen.



« Save » et « Back » button,

When a modification is made on a screen, the « Back » button is displayed in orange and « Save » button appears.

Press « Back » to leave without save.

Press « Save » to exit saving changes.



f) Selection list

When an action is symbolized by this type of button, a list will open with the corresponding elements.

Open a list >

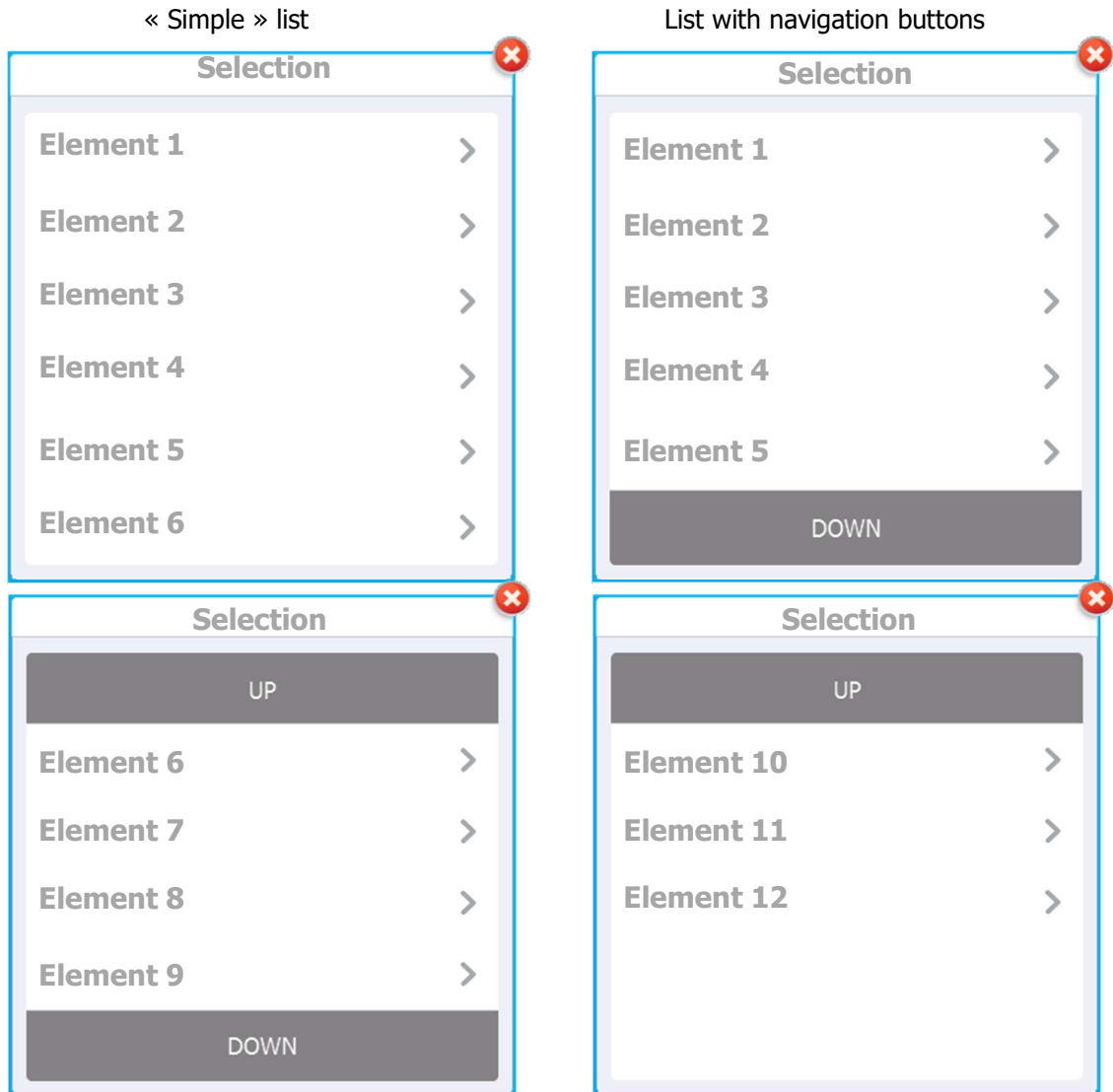
The "simple" list offers maximum of 6 items, in the event that the list is longer, navigation buttons will appear to move through the list.



-  Close the list without selection
-  Move the list down
-  Move the list up
- **To select an element press it**

g) Navigation bar

In the programming menu each selection of a function adds a button in the navigation bar.

It's possible at any time to go down one or more levels in the programming by clicking on one of the menu buttons.

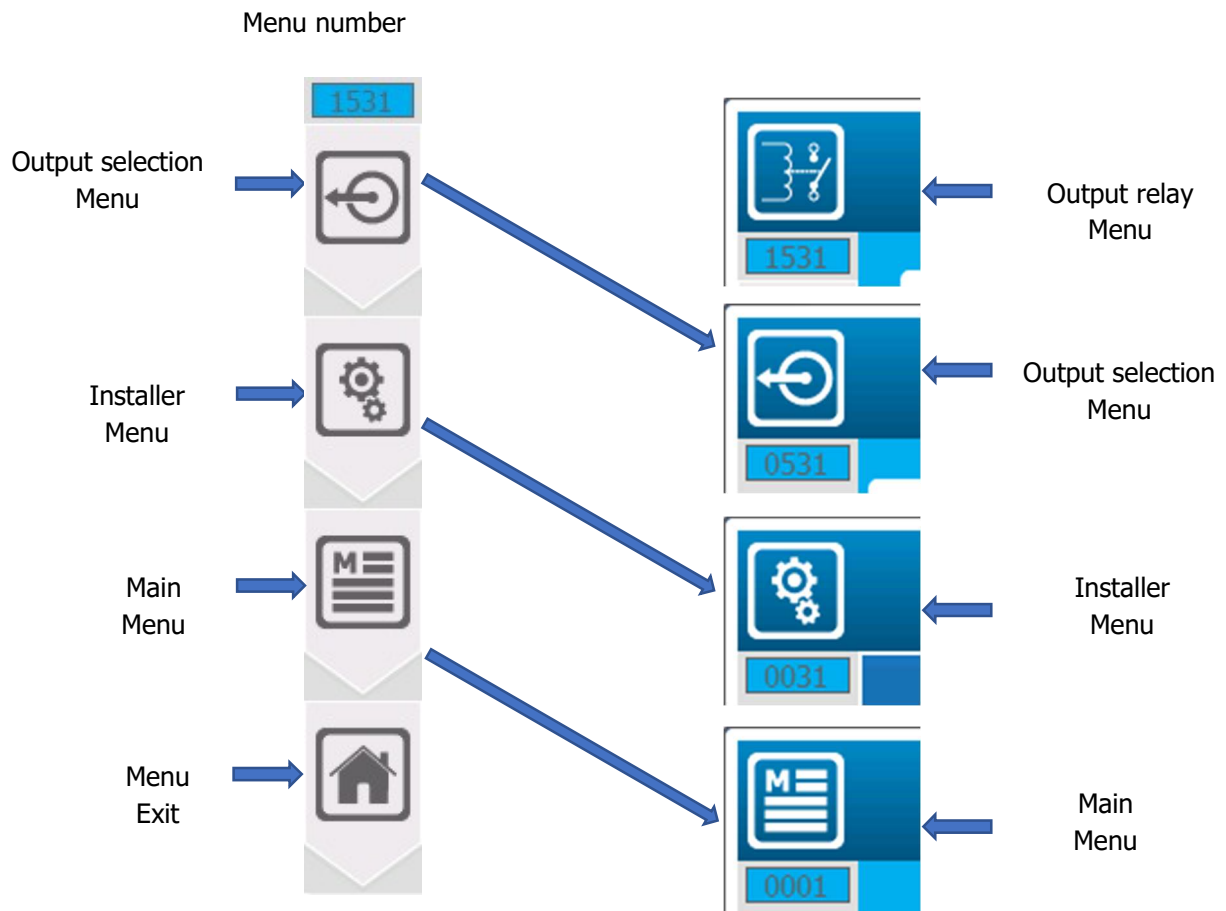
Example :

Icons in the navigation bar correspond to the identification icons in the top left of each screen.



h) Lock symbol



Padlock symbol is used when a menu is locked by a password or when an option is locked by configuration.

IX. Annexes

1) "Configuration & Installation" – "Reset Factory" menu [0831]

Press  then  and  to open following screen.

« Reset Factory» menu will allow you to reset the controller configuration by choosing a few predefined operating options..

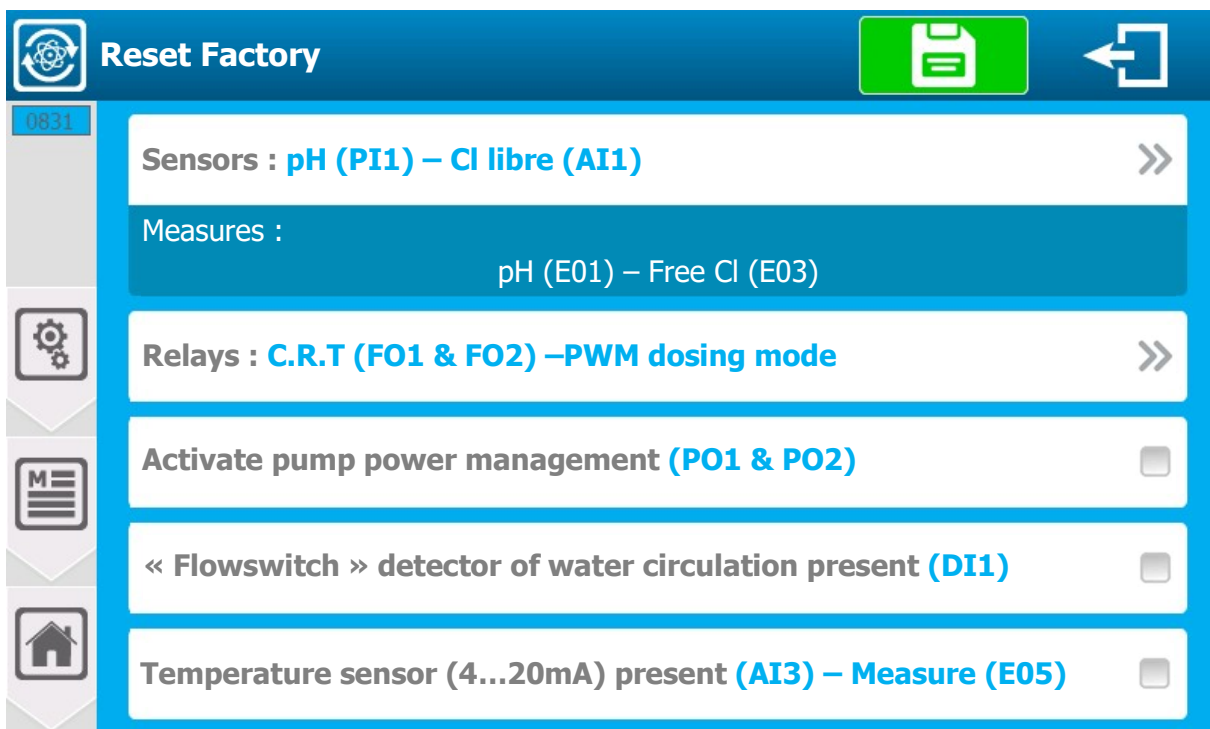

➤ Sensors

- Select the sensor configuration, from the predefined configurations :
 - **pH (PI1) – Free Cl (AI1)**
 - **pH (PI1) – ORP (PI2) – Free Cl (AI1)**
 - **pH (PI1) – Free Cl (AI1) – Total Cl (AI2)**
 - **pH (PI1) – ORP (PI2) – Free Cl (AI1) – Total Cl (AI2)**

➤ Relays

- Select configuration of the dosing relays, from the predefined configurations :
 - **NO/NC (FO1 & FO2) –PWM dosing mode**
 - **Electronic (RO1 & RO2) –PFM dosing mode**
 - **Self-powered (PO1 & PO2) – ON/OFF dosing mode**

- **Activate pump power management**
 - When using C.R.T or electronics relays for dosing, it's possible to use the two self-powered relays to supply pumps. To do this you must select this option.
- **« Flowswitch » detector of water circulation present**
 - If your installation has a water circulation detector in the measure chambers you can check this box to configure the input.
- **Temperature sensor (4...20mA) present**
 - If your installation has a temperature measurement sensor you can check this box to configure the input.
- **Press 'Save' button to validate your configuration.**

So you can reset or not the User and Communication configurations in addition to the installation and adjustment section.

Factory initialization
Check the configuration to initialize.

User	<input type="checkbox"/>
Communication	<input type="checkbox"/>
Installation & Settings	<input checked="" type="checkbox"/>

NOYES



It's also possible is necessary or request from technical support to reset only Communication or User part by checking only the box concerned.

2) « User » - « DATE & TIME » menu [0311]

Press  then  and  to open following screen

« DATE & TIME » menu will allow you to access the configuration of the time parameters.

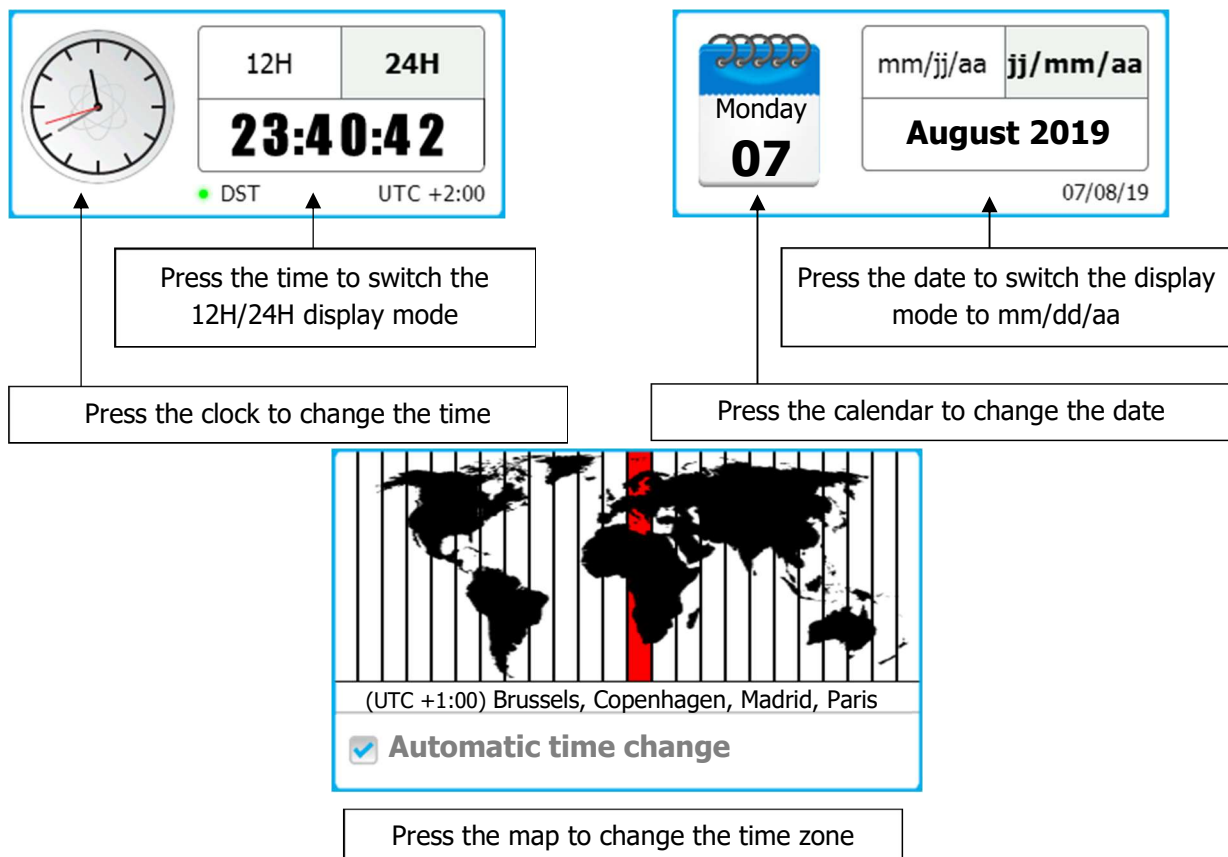
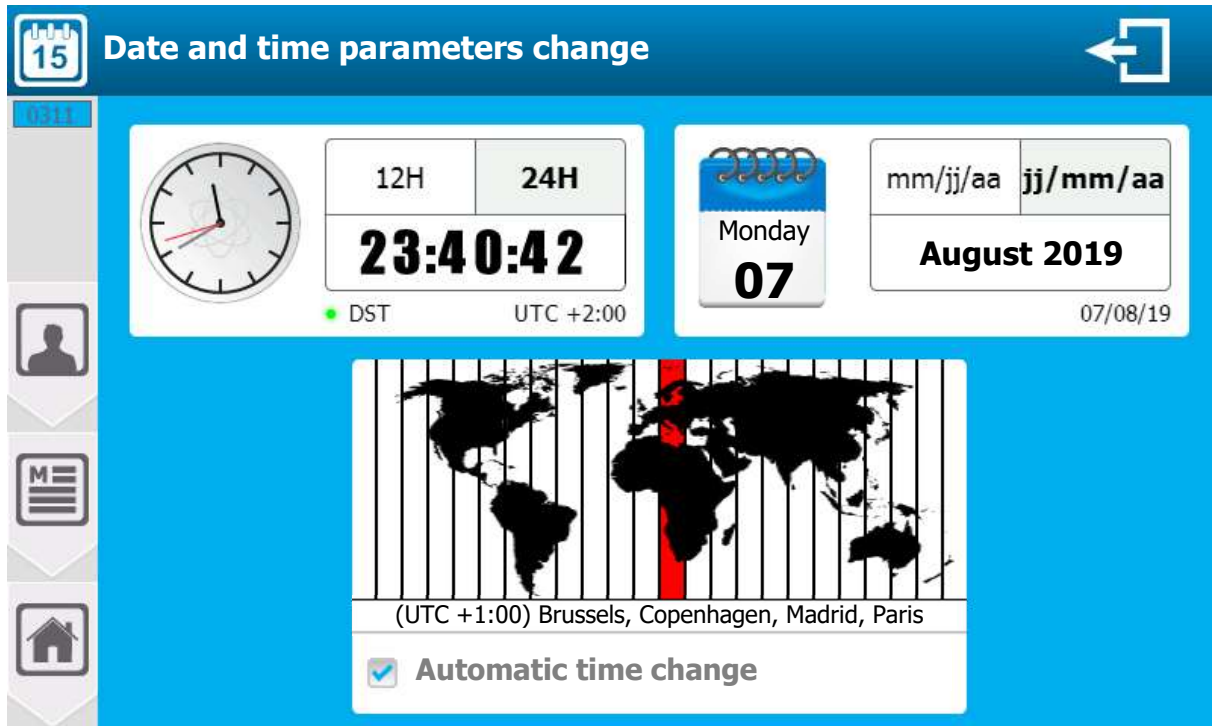

➤ **Automatic time change**

- If the selected time zone has summer time / winter time management, your controller will change the time automatically. You can cancel this automatic time change by unchecking this box.

➤ **Time zone change**

- Press the map
- Scroll up or down the list, by pressing and holding, until the desired zone is in the central part of the selection.
- Wait for automatic closing to take the new time zone in account.

(UTC +1:00)	Central Africa - West
(UTC +1:00)	Amsterdam, Berlin, Bern, Rome, Stockholm, Vienna
(UTC +1:00)	Belgrade, Bratislava, Budapest, Ljubljana, Prague
(UTC +1:00)	Brussels, Copenhagen, Madrid, Paris
(UTC +1:00)	Sarajevo, Skopje, Varsovie, Zagreb
(UTC +2:00)	Standard time UTC+02
(UTC +2:00)	Amman

3) Backup battery changement



Before changing the battery, switch off the power supply !



Always use the same battery as the original.

Open the transparent door and unscrew the 4 front screws using an appropriate screwdriver. Carefully disconnect the connection flat cable connecting the bottom card and the upper part of the device,



- Locate the button cell to be changed

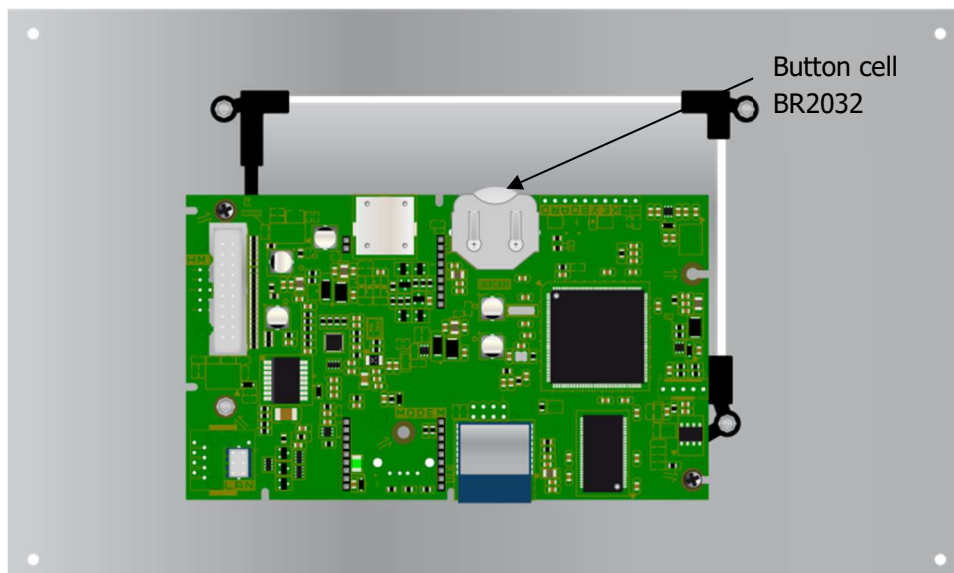

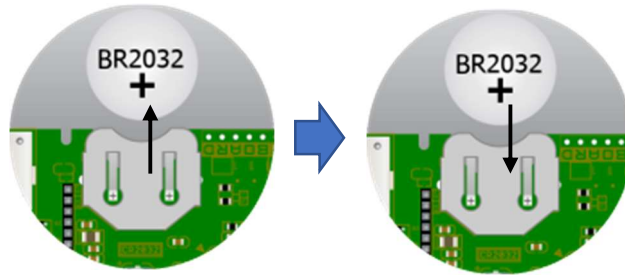

- Remove the button cell
- Put the new button cell

- Reconnect the flat cable between the cards and reassemble the front panel using the 4 fixing screws. Don't overtighten because the screws are fixed in the plastic case.



Reconnect the flat cable and replace the front panel before switching on the power supply.

4) Installation of the auxiliary module



Before installing the auxiliary module, cut off the power supplies.

Open the transparent door and unscrew the 4 front screws using an appropriate screwdriver. Carefully disconnect the connection flat cable connecting the bottom card and the upper part of the device

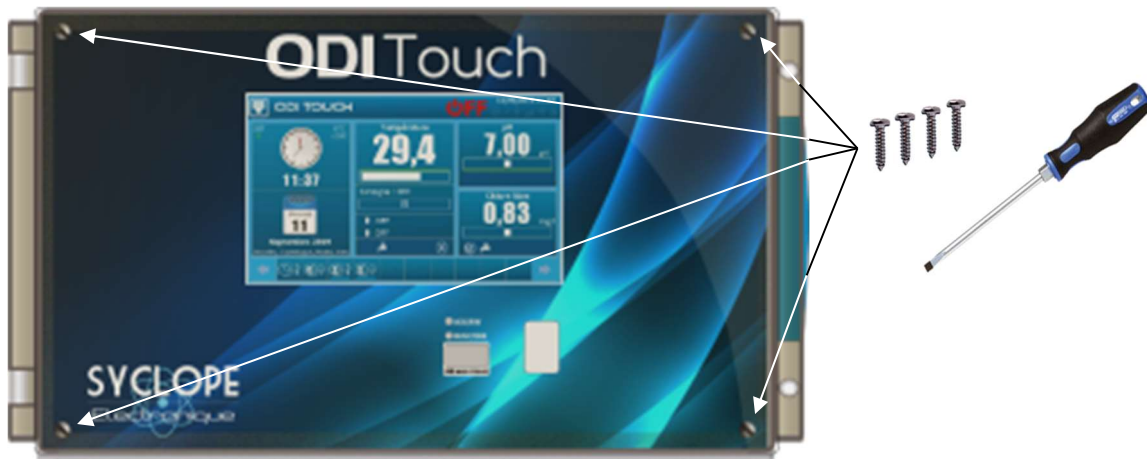

- Locate the position of the auxiliary module

Location of the auxiliary module

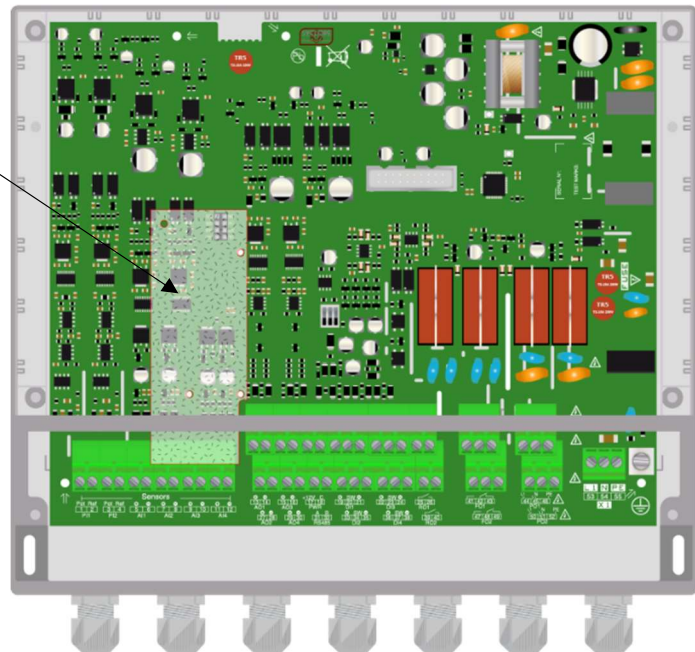

- Position the three balusters then insert the module in the connector on the backplane. Be careful to secure the balusters in the holes provided.

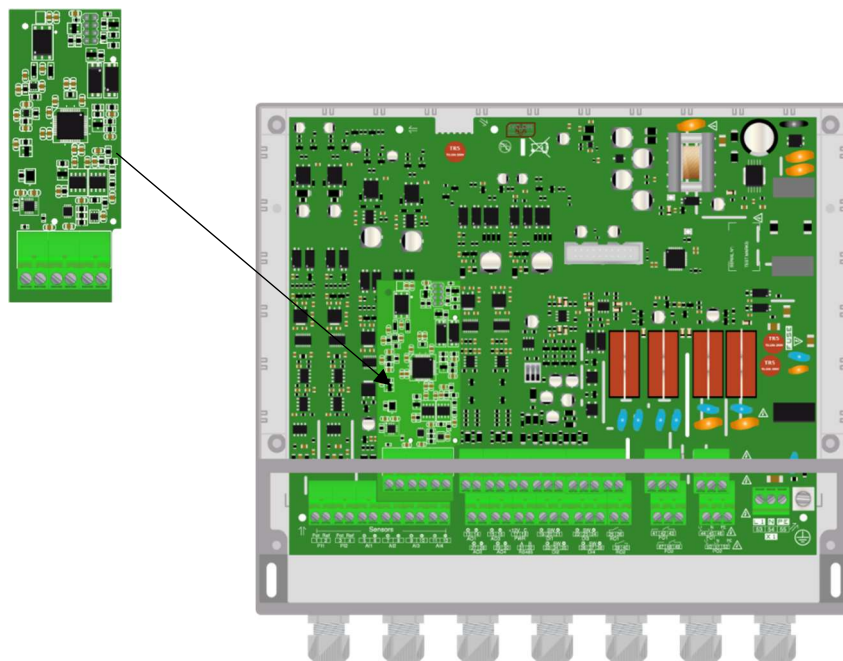

- Reconnect the flat cable between the cards and reassemble the front panel using the 4 fixing screws. Don't overtighten because the screws are fixed in the plastic case.



Reconnect the flat cable and replace the front panel before switching on the power supply.



SYCLOPE Electronique S.A.S.

Z.I. Aéroport Pyrénées

64 230 SAUVAGNON

Tel: (33) 05 59 33 70 36

Fax: (33) 05 59 33 70 37

Email: service-technique@syclope.fr

© 2018 by SYCLOPE Electronique S.A.S.
Subject to modification.