

3.9. Band Edge and Spurious Emission (Conducted)

LIMIT

FCC CFR Title 47 Part 15 Subpart C Section 15.247 (d):

In any 100 kHz bandwidth outside the frequency band in which the spread spectrum intentional radiator is operating, the radio frequency power that is produced by the intentional radiator shall be at least 20 dB below that in the 100 kHz bandwidth within the band that contains the highest level of the desired power, based on either an RF conducted or a radiated measurement.

TEST CONFIGURATION

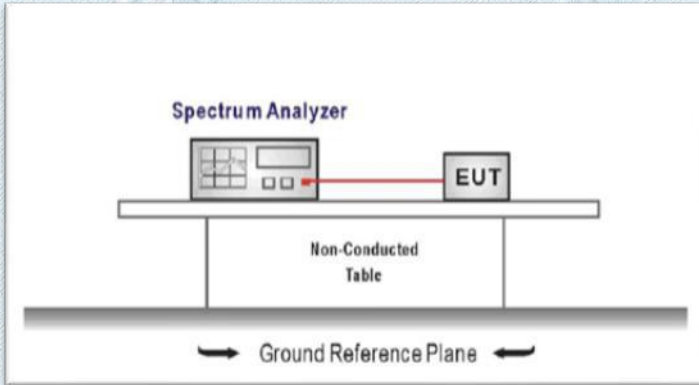

TEST PROCEDURE

1. Connect EUT RF Output port to the Spectrum Analyzer through an RF attenuator.

2. Spectrum Setting:

RBW=100KHz

VBW=3*RBW.

Detector function: Peak.

Trace: Max hold.

Sweep = Auto couple.

Allow the trace to stabilize.

TEST MODE:

Please refer to the clause 2.3.

TEST RESULTS

DH5

CH00-Bandedge

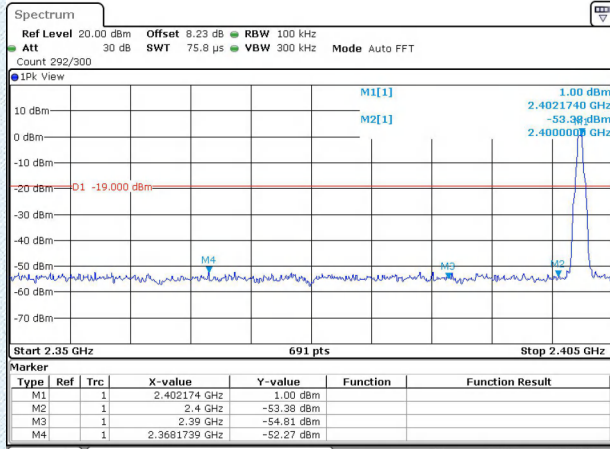

Date: 10.MAY.2021 10:41:23

CH78-Bandedge

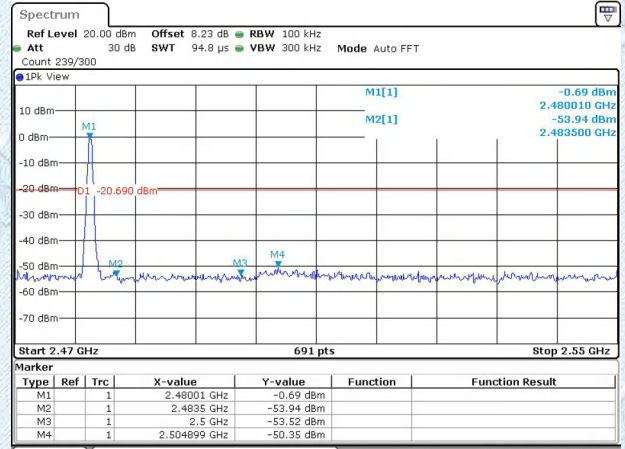

Date: 10.MAY.2021 11:14:50

DH5

CH00-SE

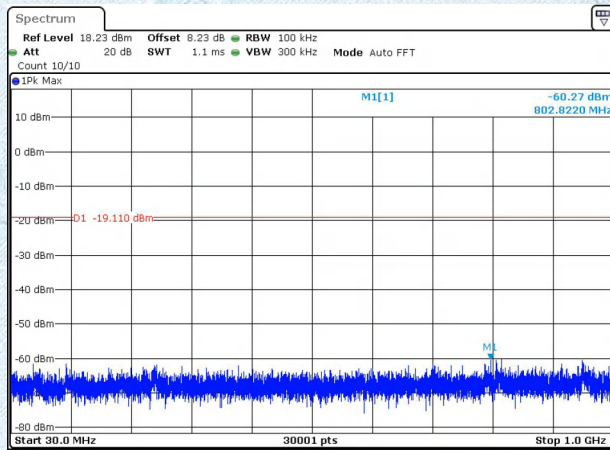

Date: 10.MAY.2021 10:46:05

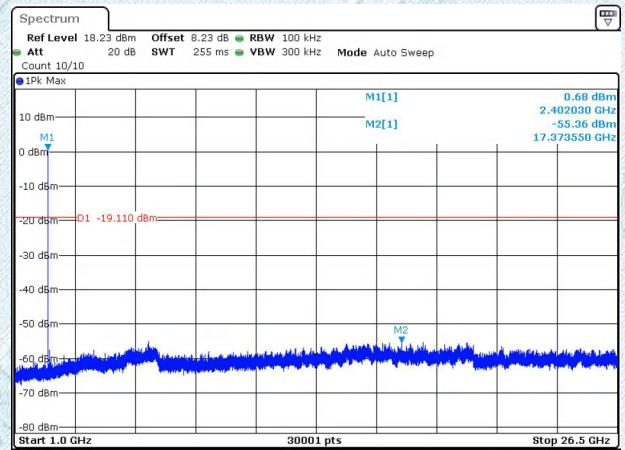

Date: 10.MAY.2021 10:46:28

CH39-SE

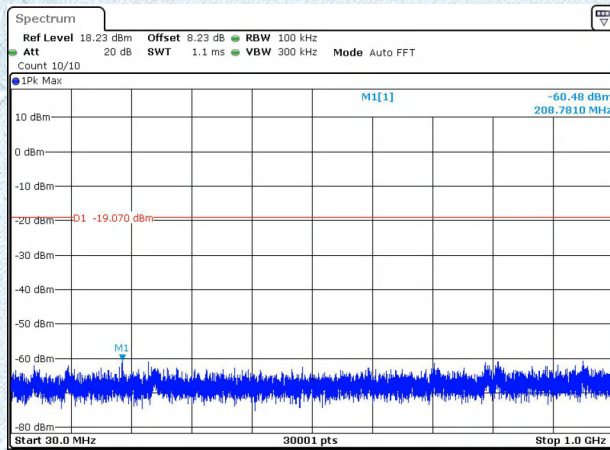

Date: 10.MAY.2021 11:12:35

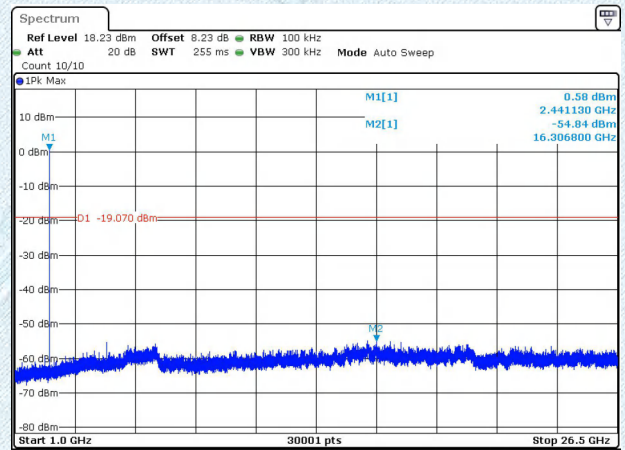

Date: 10.MAY.2021 11:12:58

CH78-SE

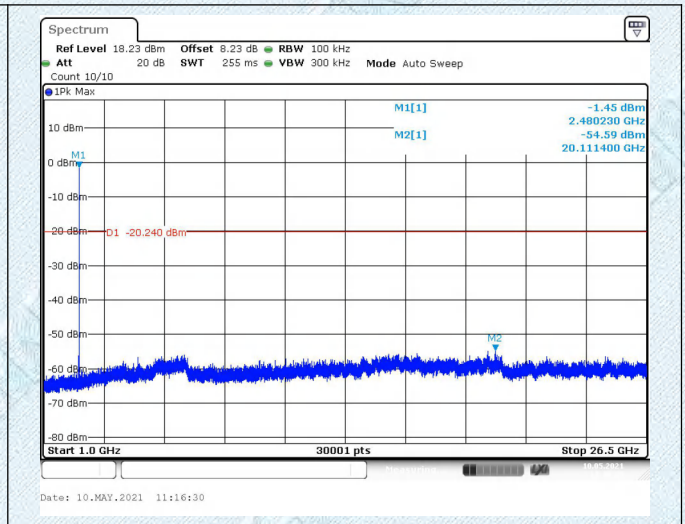
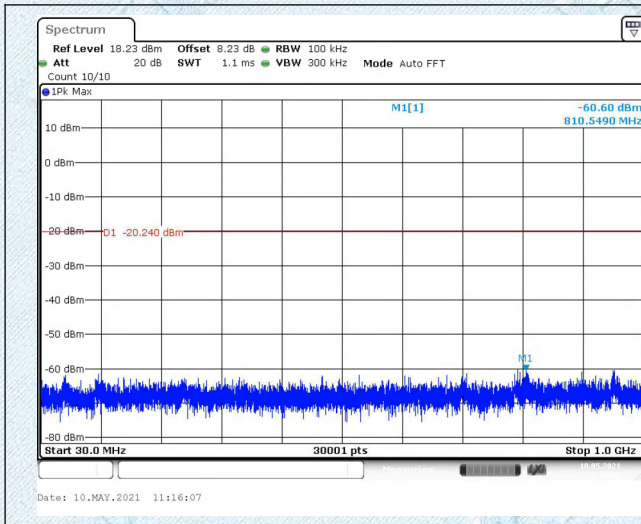

2DH5

CH00-Bandedge

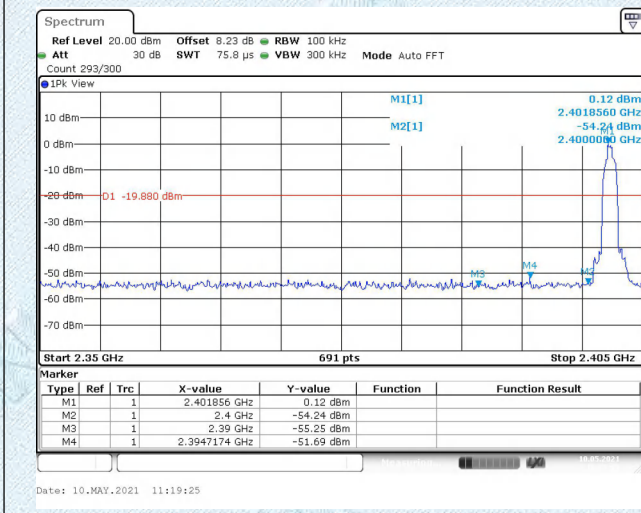

CH78-Bandedge

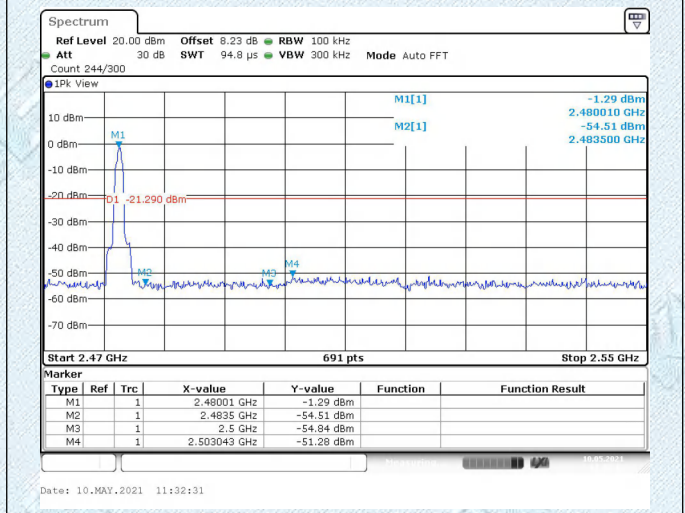

2DH5

CH00-SE

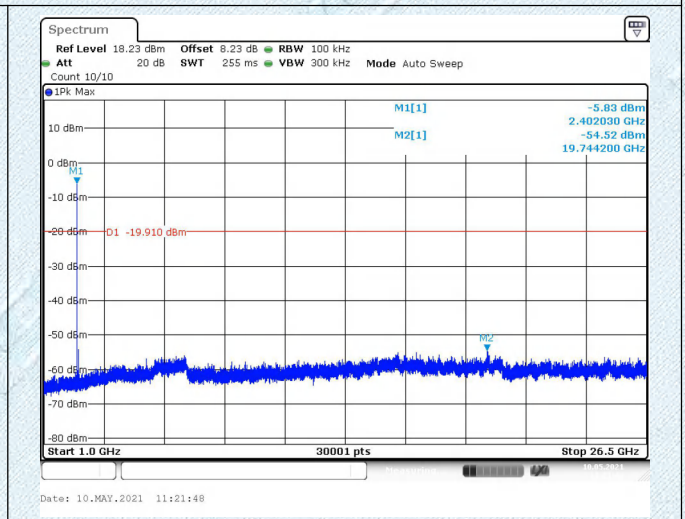
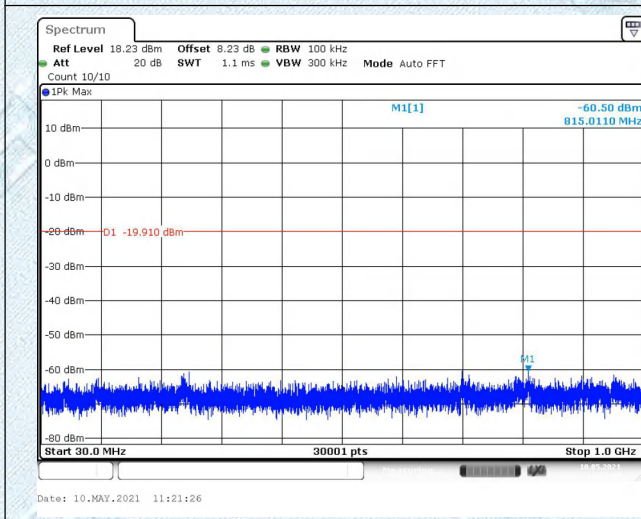

CH39-SE

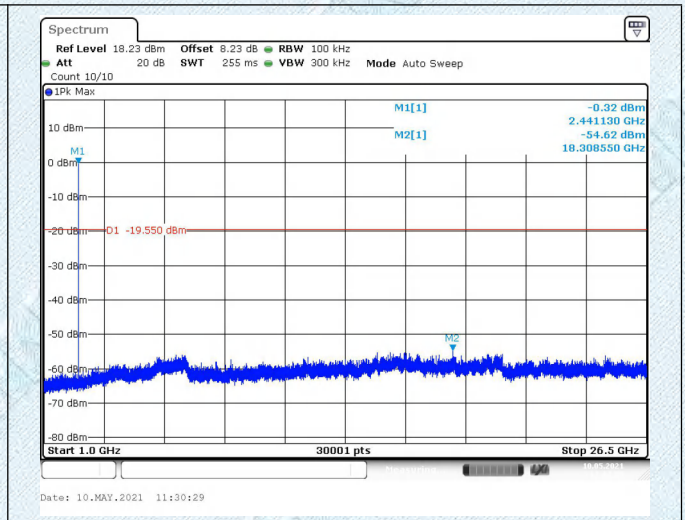
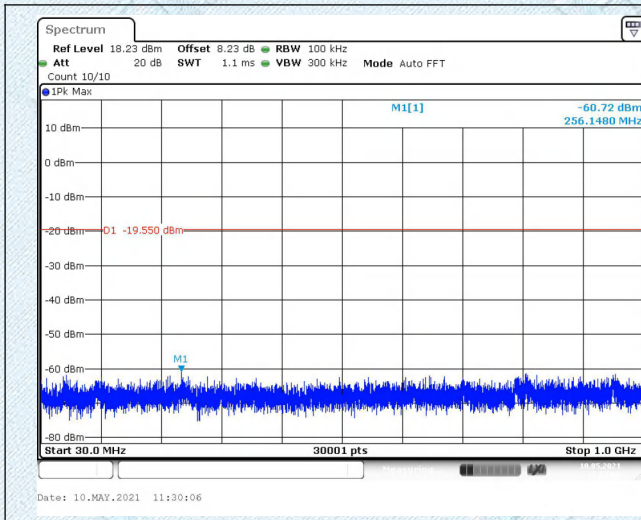

CH78-SE

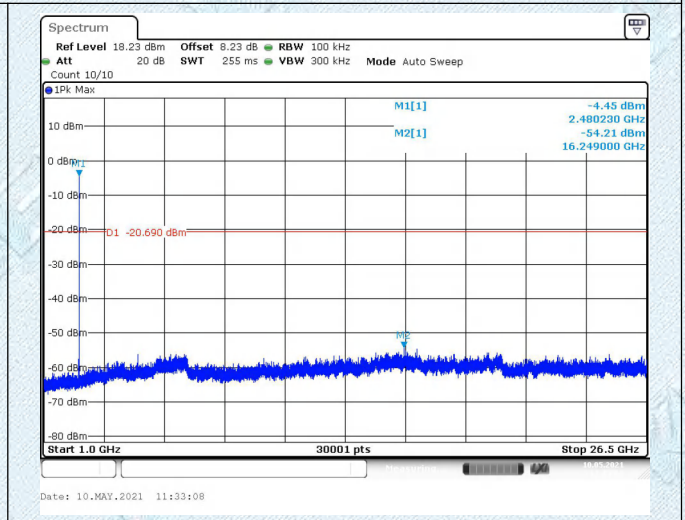
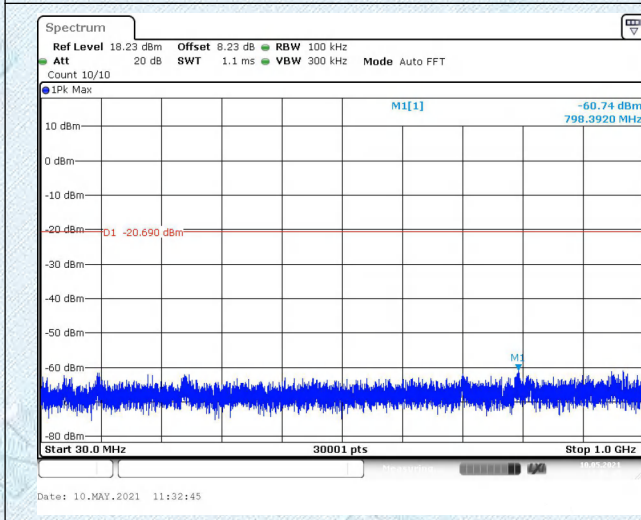

3DH5

CH00-Bandedge

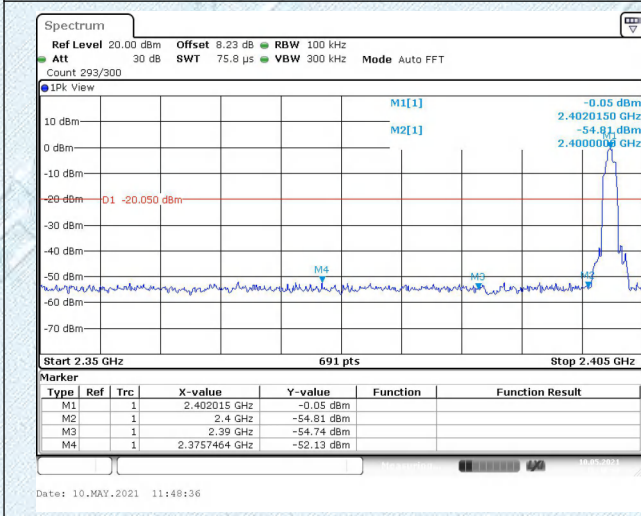

CH78-Bandedge

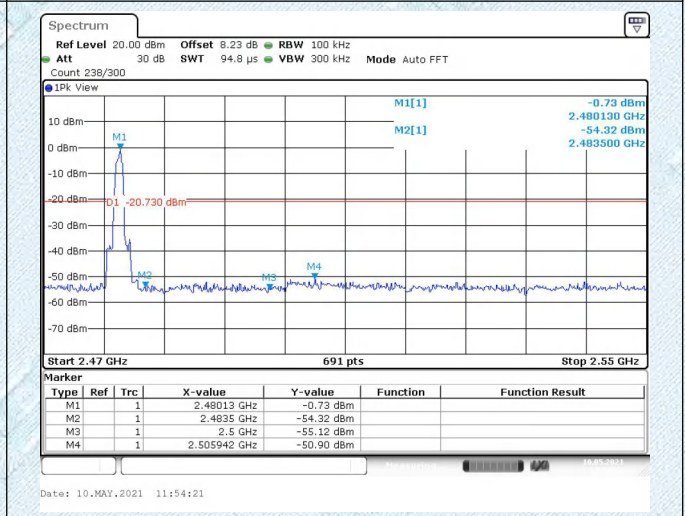

3DH5

CH00-SE

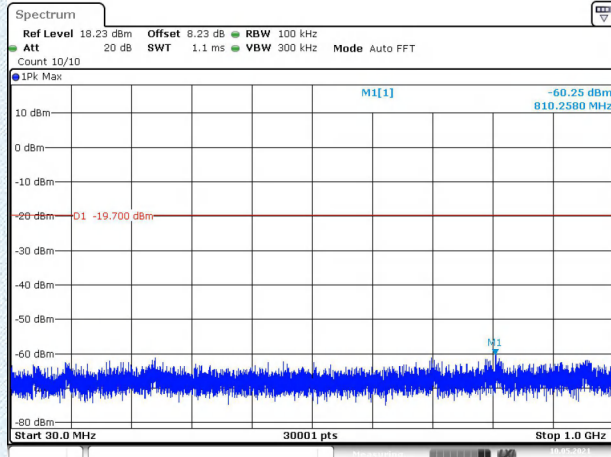

Date: 10.MAY.2021 11:50:04

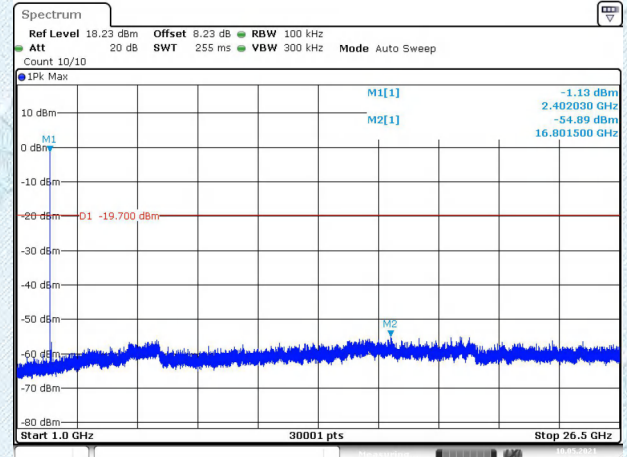

Date: 10.MAY.2021 11:50:27

CH39-SE

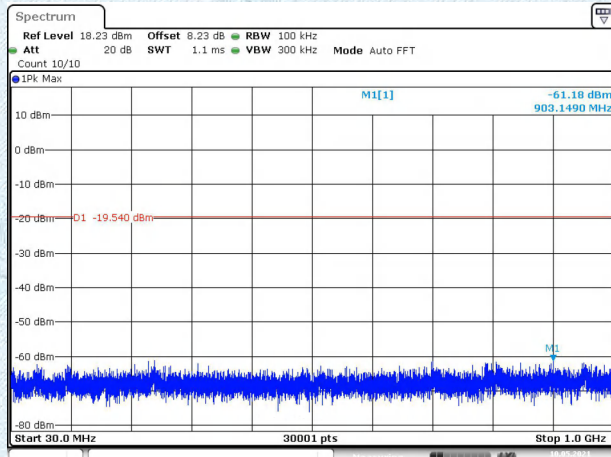

Date: 10.MAY.2021 11:51:41

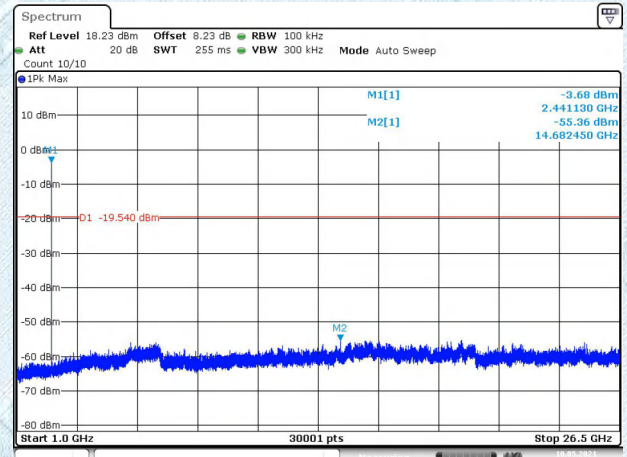

Date: 10.MAY.2021 11:52:04

CH78-SE

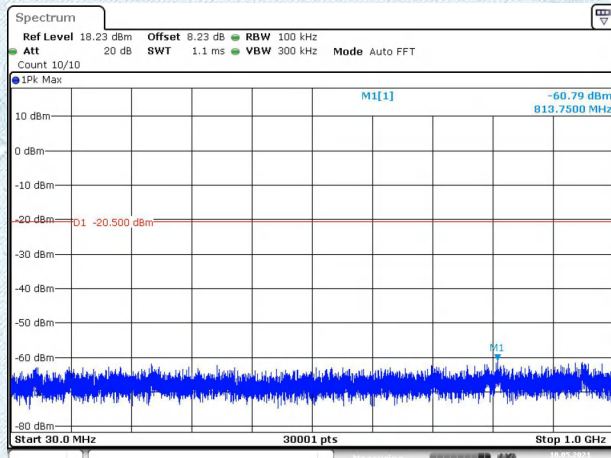

Date: 10.MAY.2021 11:54:57

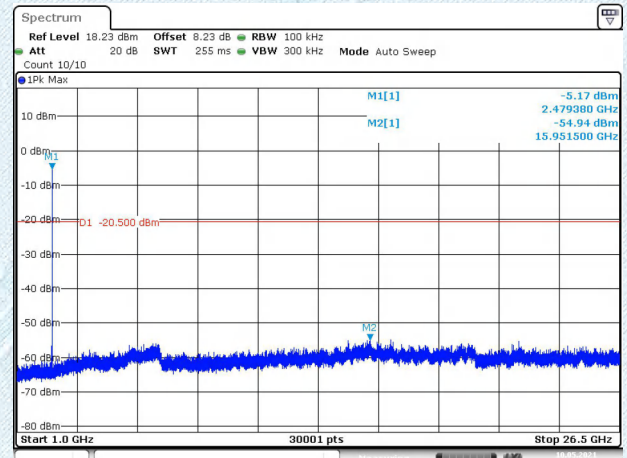

Date: 10.MAY.2021 11:55:20

DH5(2402)-Hopping on

DH5(2480)-Hopping on

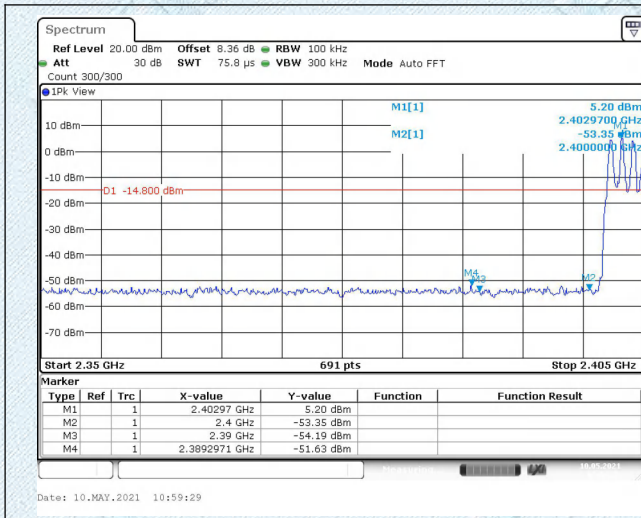

2DH5(2402)-Hopping on

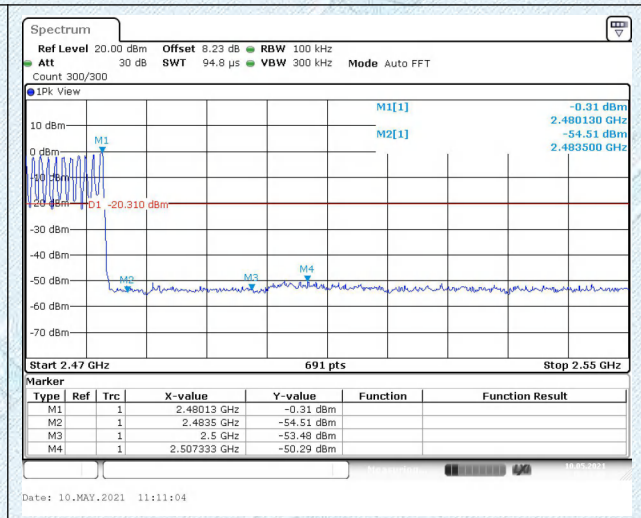

2DH5(2480)-Hopping on

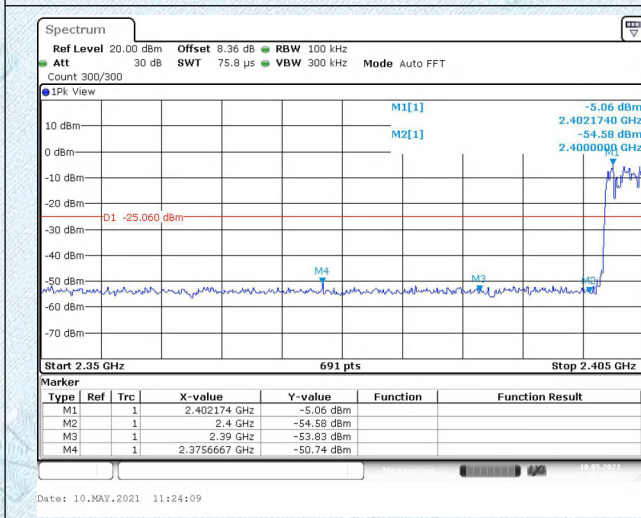

3DH5(2402)-Hopping on

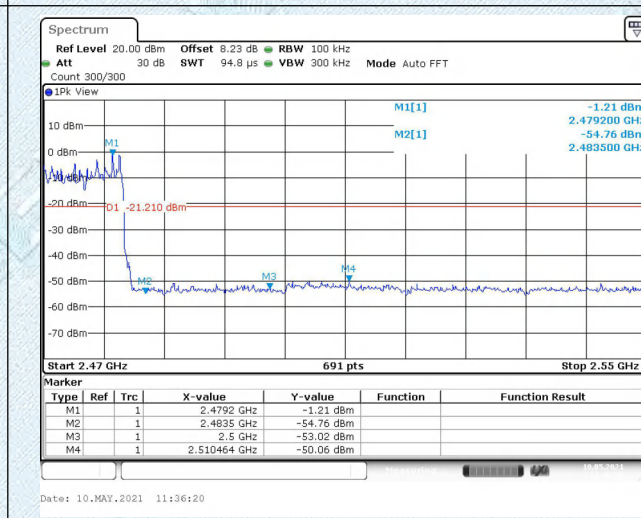

3DH5(2480)-Hopping on

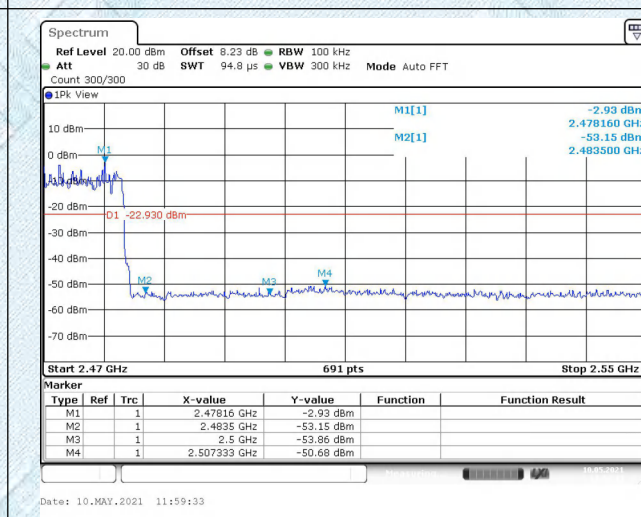
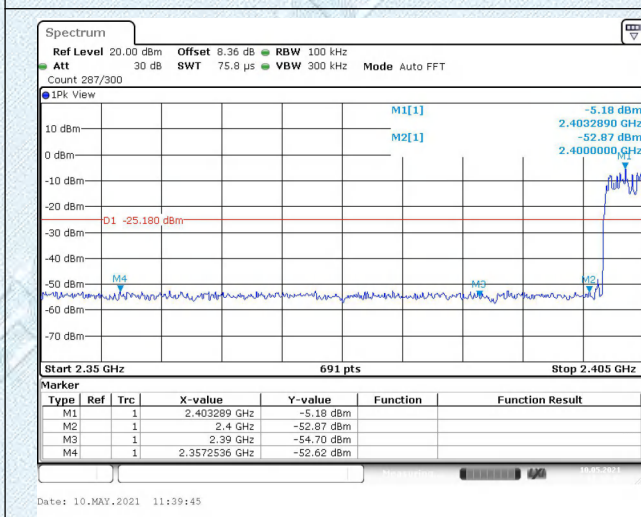

3.10. Radiated Spurious Emissions

Limit

Radiated Emission Limits (9 kHz~1000 MHz)

Frequency (MHz)	Field Strength (microvolt/meter)	Measurement Distance (meters)
0.009~0.490	2400/F(KHz)	300
0.490~1.705	24000/F(KHz)	30
1.705~30.0	30	30
30~88	100	3
88~216	150	3
216~960	200	3
Above 960	500	3

Radiated Emission Limit (Above 1000MHz)

Frequency (MHz)	Distance Meters(at 3m)	
	Peak	Average
Above 1000	74	54

Note:

- (1) The tighter limit applies at the band edges.
- (2) Emission Level (dBuV/m)=20log Emission Level (uV/m).

Test Configuration

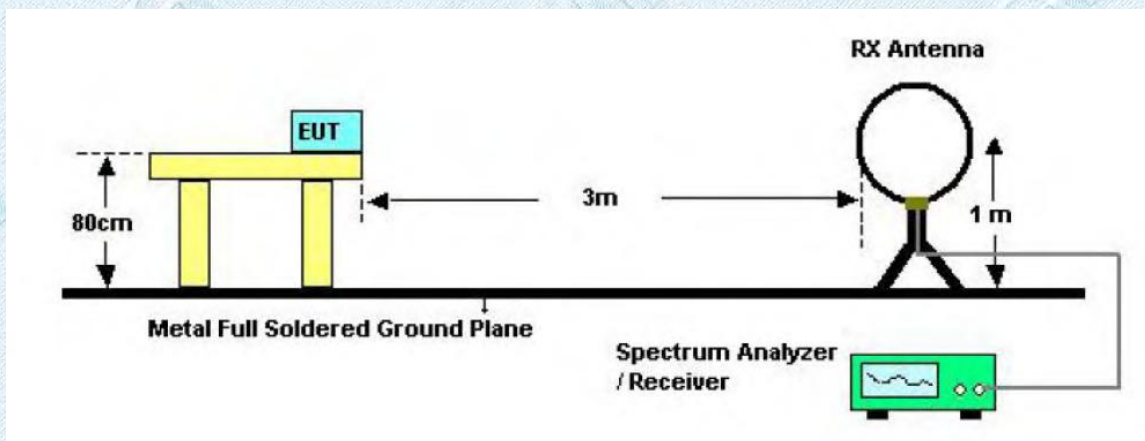

Below 30MHz Test Setup

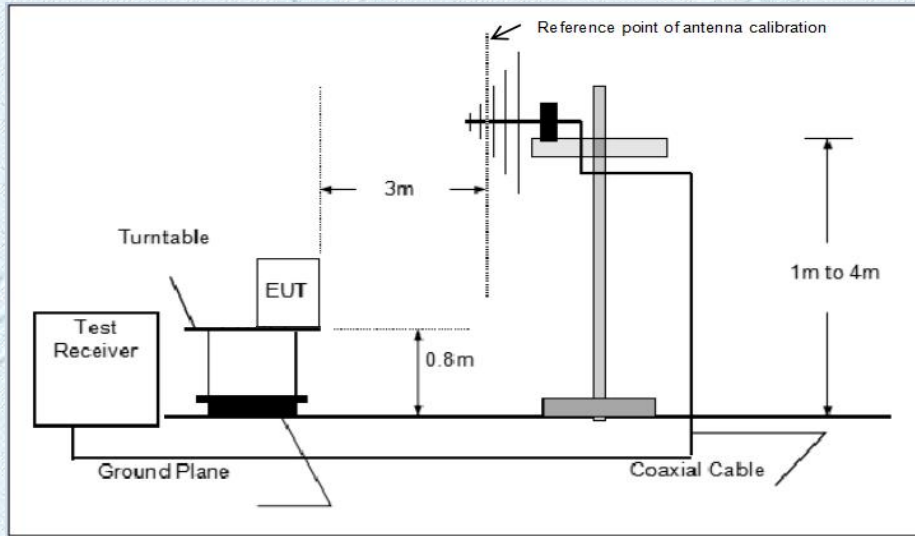

Below 1000MHz Test Setup

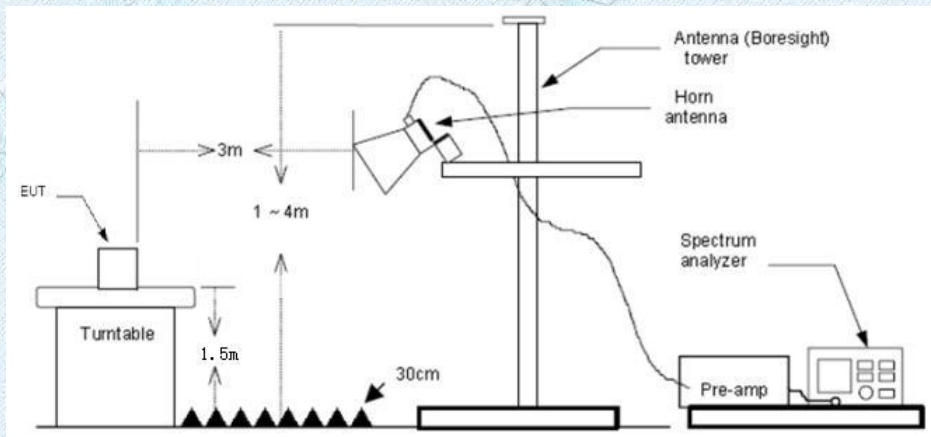

Above 1GHz Test Setup

Test Procedure

1. The EUT was setup and tested according to ANSI C63.10:2013
2. The EUT is placed on a turn table which is 0.8 meter above ground for below 1 GHz, and 1.5 m for above 1 GHz. The turn table is rotated 360 degrees to determine the position of the maximum emission level.
3. The EUT was set 3 meters from the receiving antenna, which was mounted on the top of a variable height antenna tower.
4. For each suspected emission, the EUT was arranged to its worst case and then tune the Antenna tower (from 1 m to 4 m) and turntable (from 0 degree to 360 degrees) to find the maximum reading. A pre-amp and a high pass filter are used for the test in order to get better signal level to comply with the guidelines.
5. Set to the maximum power setting and enable the EUT transmit continuously.
6. Use the following spectrum analyzer settings
 - (1) Span shall wide enough to fully capture the emission being measured;
 - (2) Below 1 GHz:
 RBW=120 kHz, VBW=300 kHz, Sweep=auto, Detector function=peak, Trace=max hold;
 If the emission level of the EUT measured by the peak detector is 3 dB lower than the applicable limit, the peak emission level will be reported. Otherwise, the emission measurement will be repeated using the quasi-peak detector and reported.
 - (3) From 1 GHz to 10th harmonic:
 RBW=1MHz, VBW=3MHz Peak detector for Peak value.
 RBW=1MHz, VBW=10Hz Peak detector for Average value.

Test Mode

Please refer to the clause 2.3.

Test Result**9 KHz~30 MHz and 18GHz~25GHz**

From 9 KHz~30 MHz and 18GHz~25GHz: Conclusion: PASS

Note:

- 1) Measurement = Reading level + Correct Factor
Correct Factor=Antenna Factor + Cable Loss -Preamplifier Factor
- 2) The peak level is lower than average limit(54 dBuV/m), this data is the too weak instrument of signal is unable to test.
- 3) The emission levels of other frequencies are very lower than the limit and not show in test report.
- 4) The amplitude of spurious emissions which are attenuated by more than 20dB below the permissible value has no need to be reported.
- 5) Pre-scan DH5, 2DH5 and 3DH5 modulation, and found the DH5 modulation 2402MHz which it is worse case for 30MHz-1GHz , so only show the test data for worse case.
- 6) Pre-scan DH5, 2DH5 and 3DH5 modulation, and found the DH5 modulation which it is worse case for above 1GHz, so only show the test data for worse case.

RADIATED EMISSION BELOW 30MHZ

No emission found between lowest internal used/generated frequencies to 30MHz.

30MHz-1GHz

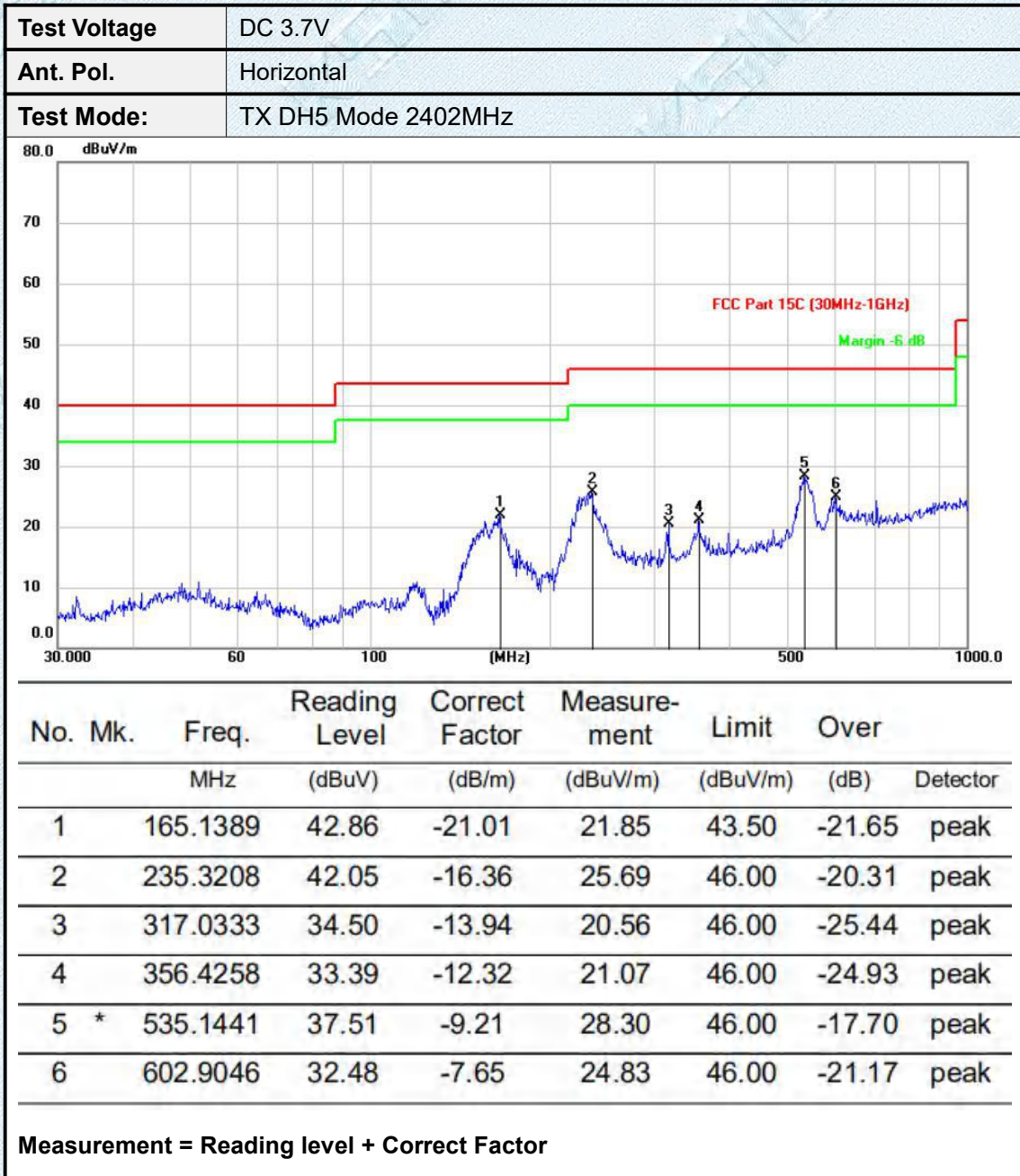

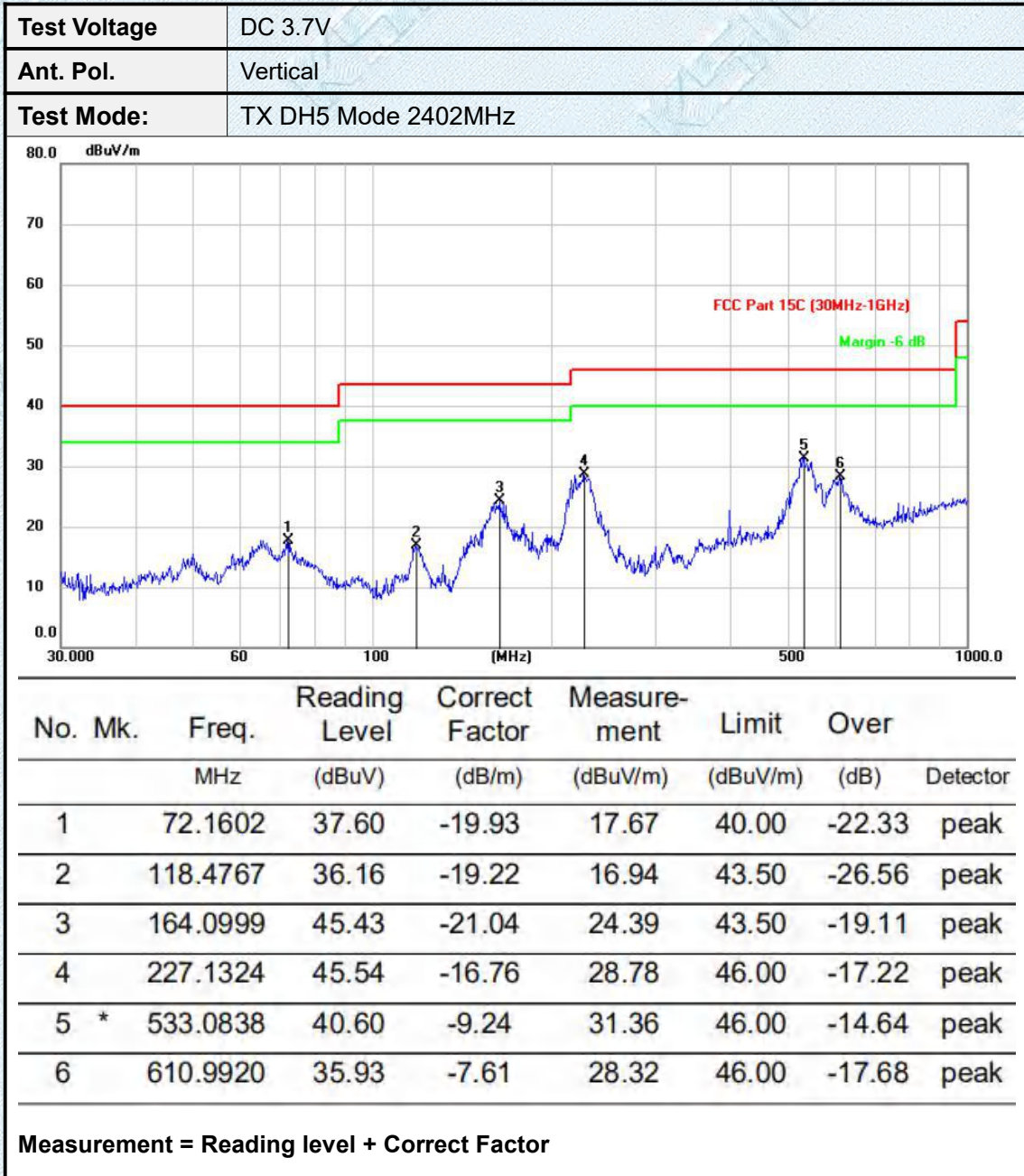

Adobe 1GHz

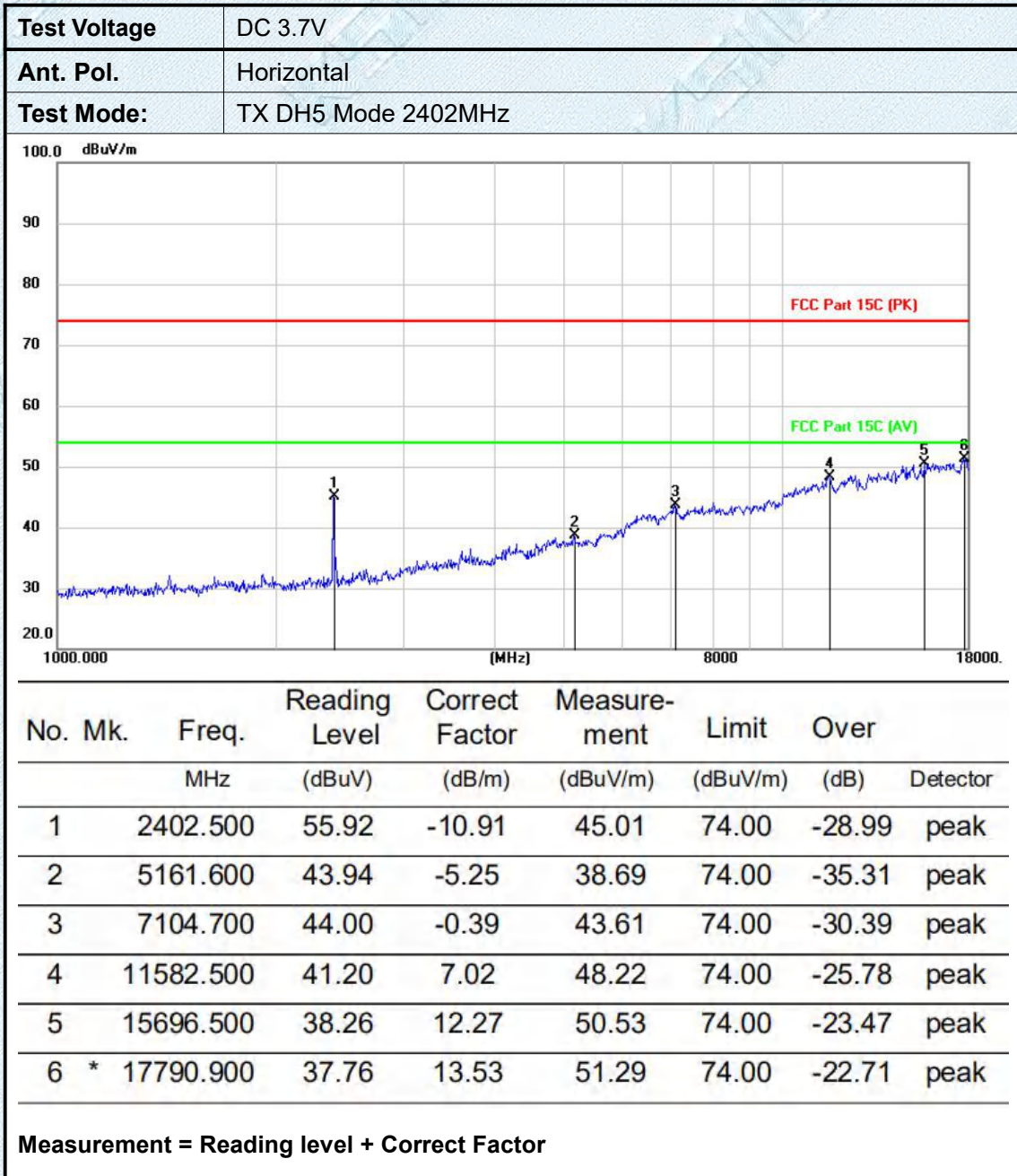

Test Voltage	DC 3.7V
Ant. Pol.	Vertical
Test Mode:	TX DH5 Mode 2402MHz



No.	Mk.	Freq. MHz	Reading Level (dBuV)	Correct Factor (dB/m)	Measure- ment (dBuV/m)	Limit (dBuV/m)	Over (dB)	Detector
1		2402.500	47.05	-10.91	36.14	74.00	-37.86	peak
2		3718.300	55.49	-9.14	46.35	74.00	-27.65	peak
3		5977.600	48.91	-3.85	45.06	74.00	-28.94	peak
4		8015.900	41.84	2.07	43.91	74.00	-30.09	peak
5		12629.700	40.16	9.22	49.38	74.00	-24.62	peak
6	*	17789.200	38.47	13.52	51.99	74.00	-22.01	peak

Measurement = Reading level + Correct Factor

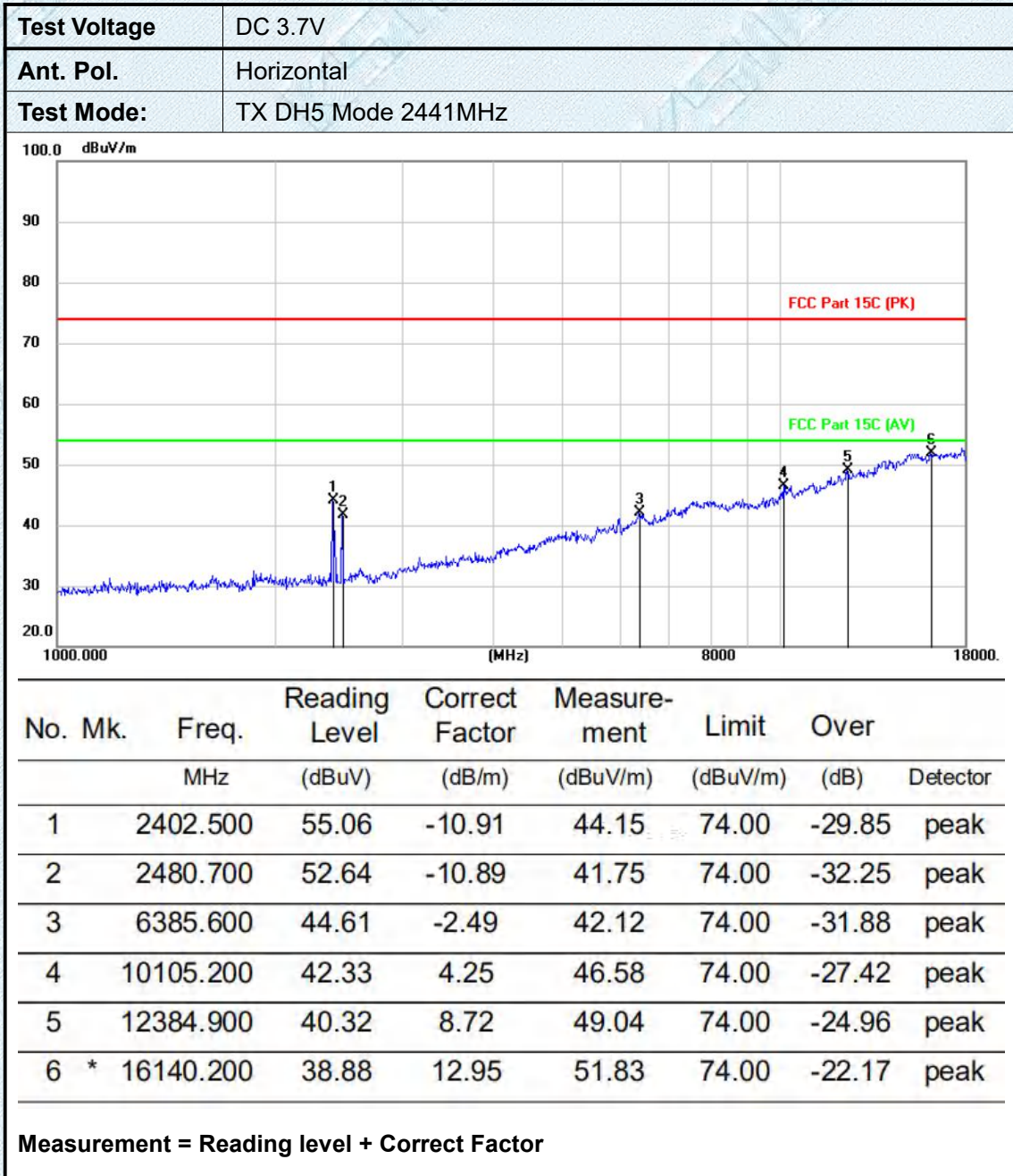

Test Voltage	DC 3.7V
Ant. Pol.	Vertical
Test Mode:	TX DH5 Mode 2441MHz

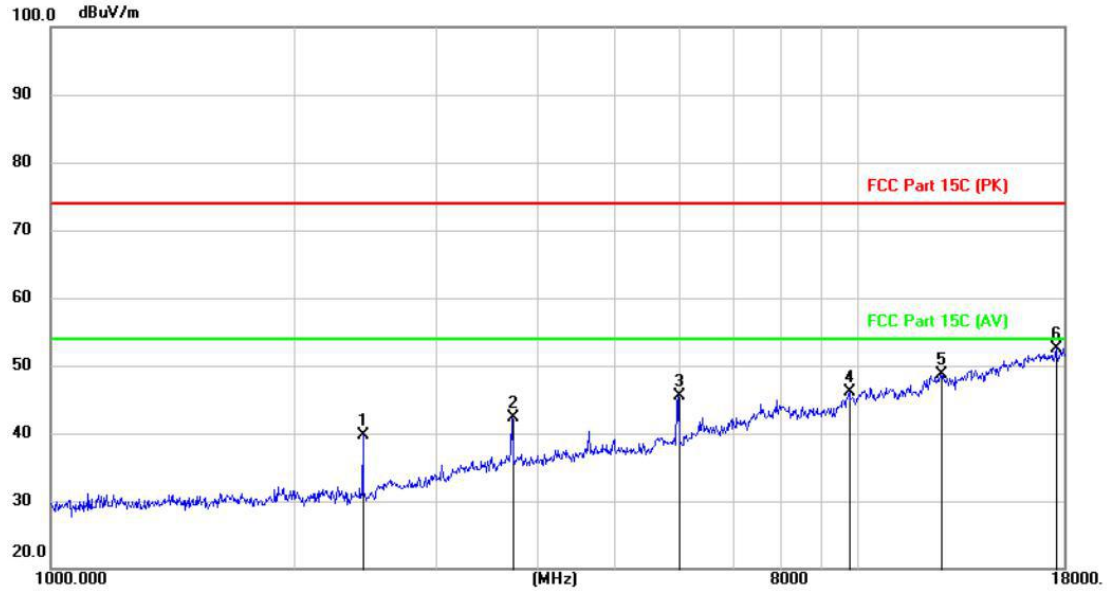

No.	Mk.	Freq. MHz	Reading Level (dBuV)	Correct Factor (dB/m)	Measure- ment (dBuV/m)	Limit (dBuV/m)	Over (dB)	Detector
1		2441.600	50.67	-10.90	39.77	74.00	-34.23	peak
2		3731.900	51.32	-9.09	42.23	74.00	-31.77	peak
3		5987.800	49.26	-3.83	45.43	74.00	-28.57	peak
4		9763.500	42.52	3.55	46.07	74.00	-27.93	peak
5		12660.300	39.49	9.27	48.76	74.00	-25.24	peak
6	*	17612.400	39.09	13.46	52.55	74.00	-21.45	peak

Measurement = Reading level + Correct Factor

Test Voltage	DC 3.7V
Ant. Pol.	Horizontal
Test Mode:	TX DH5 Mode 2480MHz



No.	Mk.	Freq. MHz	Reading Level (dBuV)	Correct Factor (dB/m)	Measure- ment (dBuV/m)	Limit (dBuV/m)	Over (dB)	Detector
1		2400.800	52.71	-10.92	41.79	74.00	-32.21	peak
2		5131.000	43.47	-5.26	38.21	74.00	-35.79	peak
3		8024.400	43.20	2.06	45.26	74.00	-28.74	peak
4		11482.200	40.04	6.81	46.85	74.00	-27.15	peak
5		13340.300	39.11	10.39	49.50	74.00	-24.50	peak
6	*	16886.500	38.82	13.21	52.03	74.00	-21.97	peak

Measurement = Reading level + Correct Factor

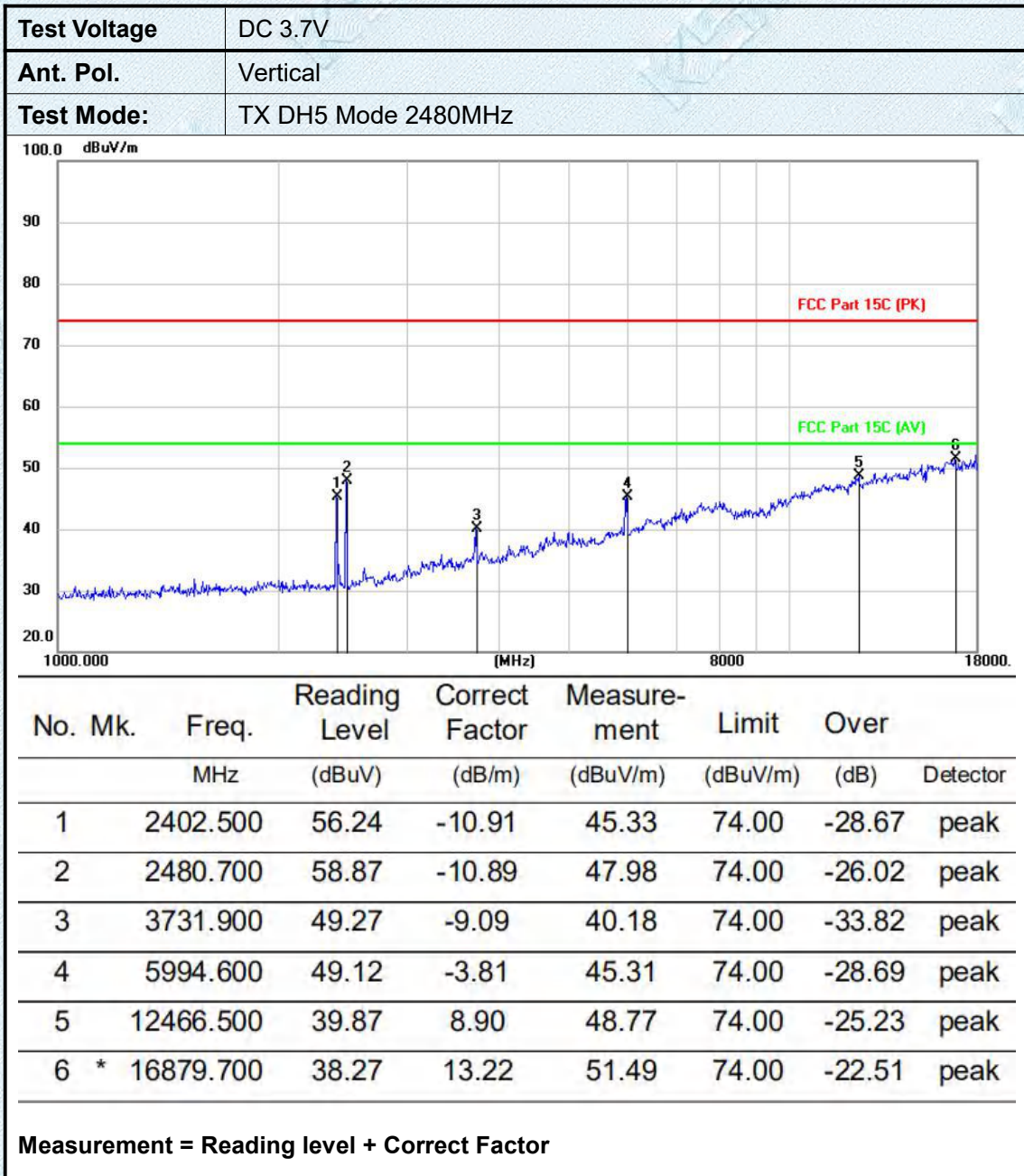

Note:

- 1.All test modes had been tested. The GFSK modulation is the worst case and recorded in the report.
- 2.The main frequency has been screened by the filter .

3.11. Pseudorandom Frequency Hopping Sequence

LIMIT

FCC CFR Title 47 Part 15 Subpart C Section 15.247 (a)(1):

Frequency hopping systems shall have hopping channel carrier frequencies separated by a minimum of 25 kHz or the 20 dB bandwidth of the hopping channel, whichever is greater. Alternatively, frequency hopping systems operating in the 2400–2483.5 MHz band may have hopping channel carrier frequencies that are separated by 25 kHz or two-thirds of the 20 dB bandwidth of the hopping channel, whichever is greater, provided the systems operate with an output power no greater than 125 mW. The system shall hop to channel frequencies that are selected at the system hopping rate from a pseudo randomly ordered list of hopping frequencies. Each frequency must be used equally on the average by each transmitter. The system receivers shall have input bandwidths that match the hopping channel bandwidths of their corresponding transmitters and shall shift frequencies in synchronization with the transmitted signals.

TEST RESULTS

The pseudorandom frequency hopping sequence may be generated in a nine-stage shift register whose 5th and 9th stage outputs are added in a modulo-two addition stage. And the result is fed back to the input of the first stage. The sequence begins with the first one of 9 consecutive ones, for example: the shift register is initialized with nine ones.

- Number of shift register stages: 9
- Length of pseudo-random sequence: $2^9 - 1 = 511$ bits
- Longest sequence of zeros: 8 (non-inverted signal)

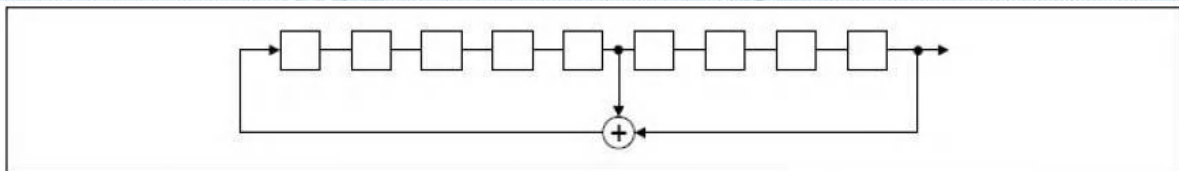

Linear Feedback Shift Register for Generation of the PRBS sequence

An example of pseudorandom frequency hopping sequence as follows:

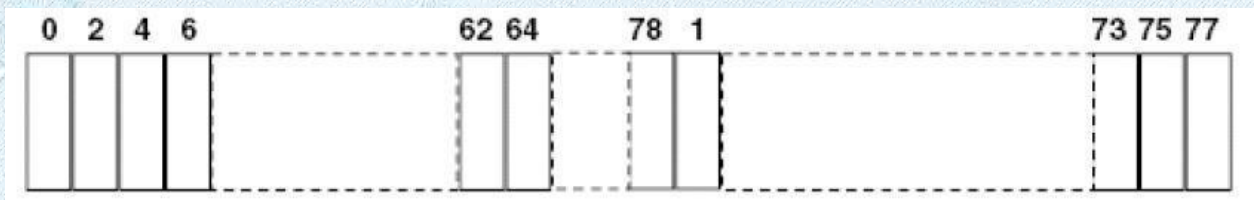

Each frequency used equally one the average by each transmitter.

The system receiver have input bandwidths that match the hopping channel bandwidths of their corresponding transmitter and shift frequencies in synchronization with the transmitted signals.

4.EUT TEST PHOTOS

Radiated Measurement (Below 1GHz)

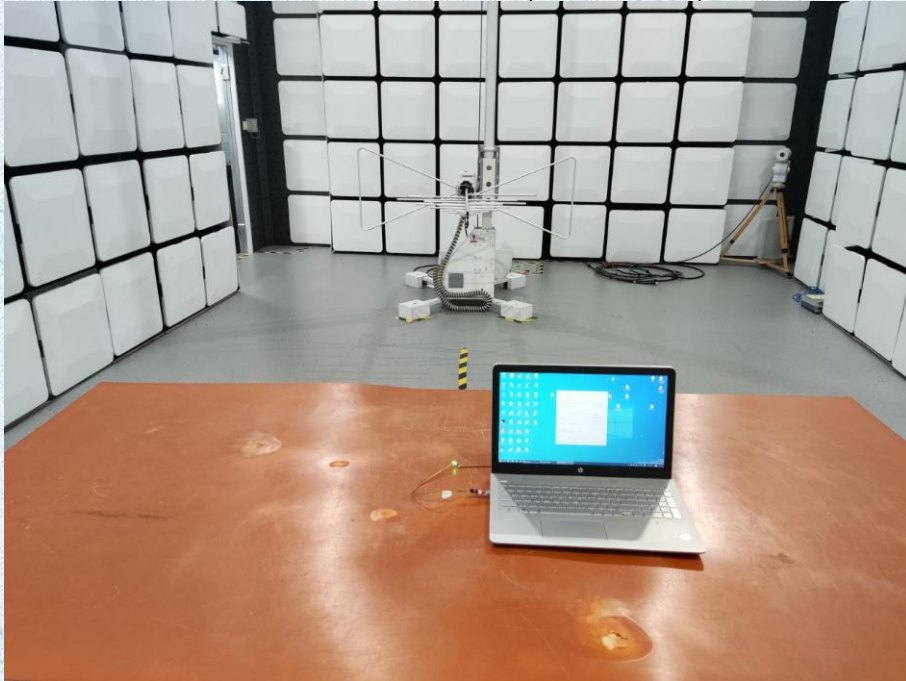

Radiated Measurement (Above 1GHz)



CONDUCTED EMISSION TEST SETUP

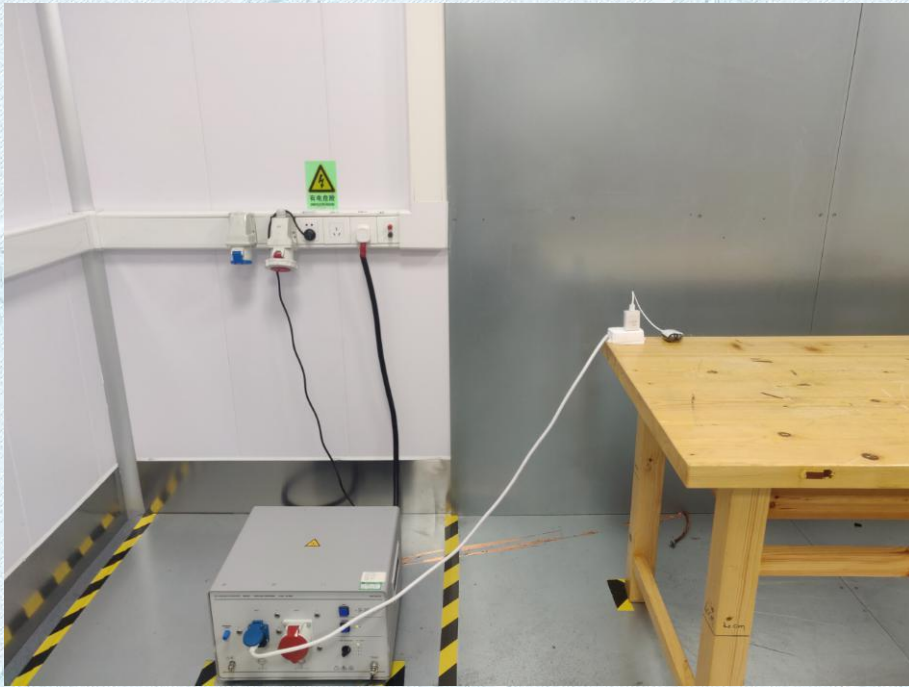

RF Conducted



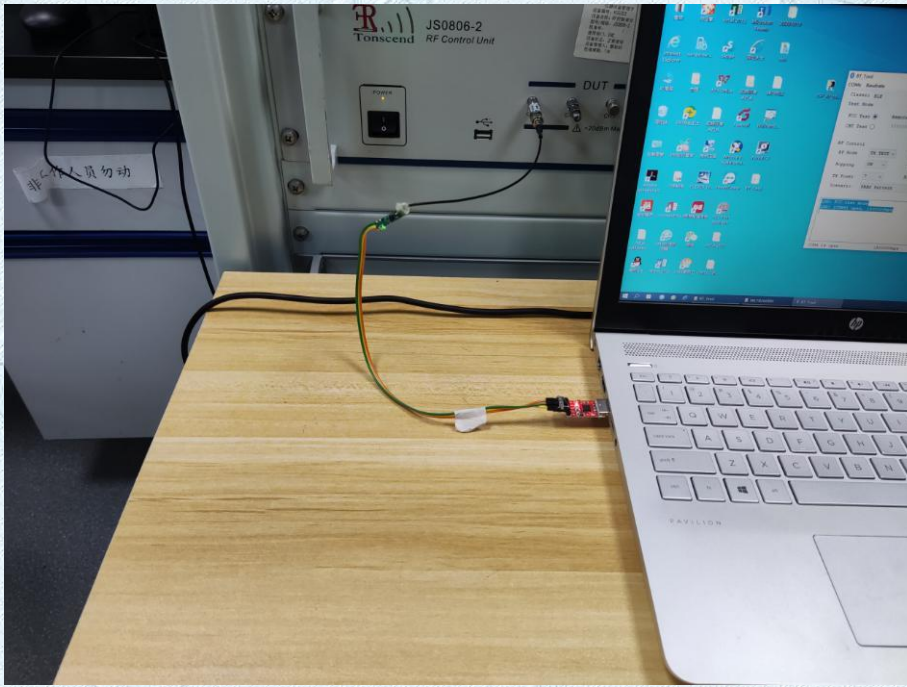

5. PHOTOGRAPHS OF EUT CONSTRUCTIONAL

External Photographs

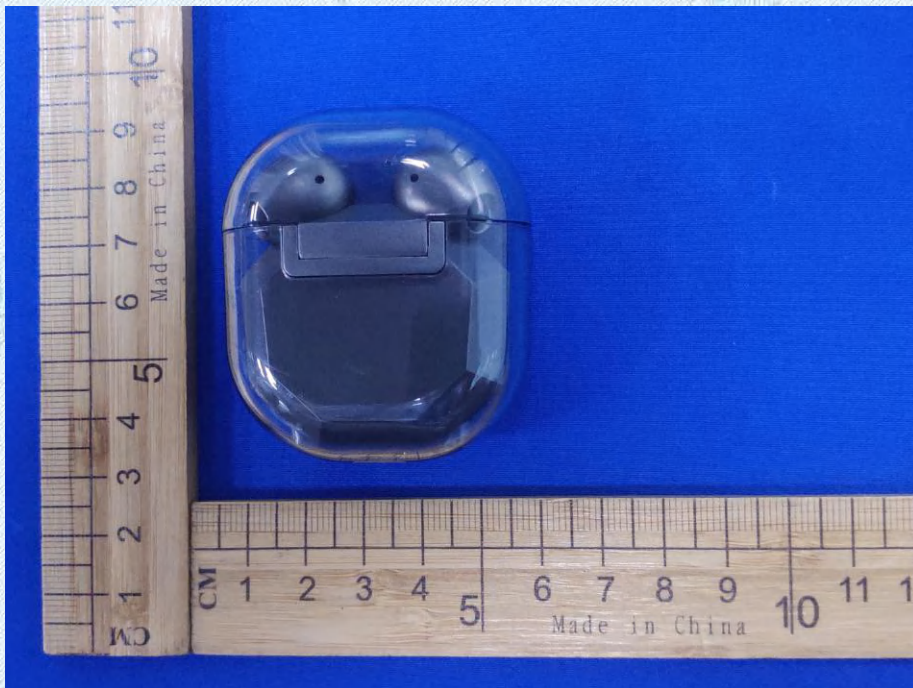
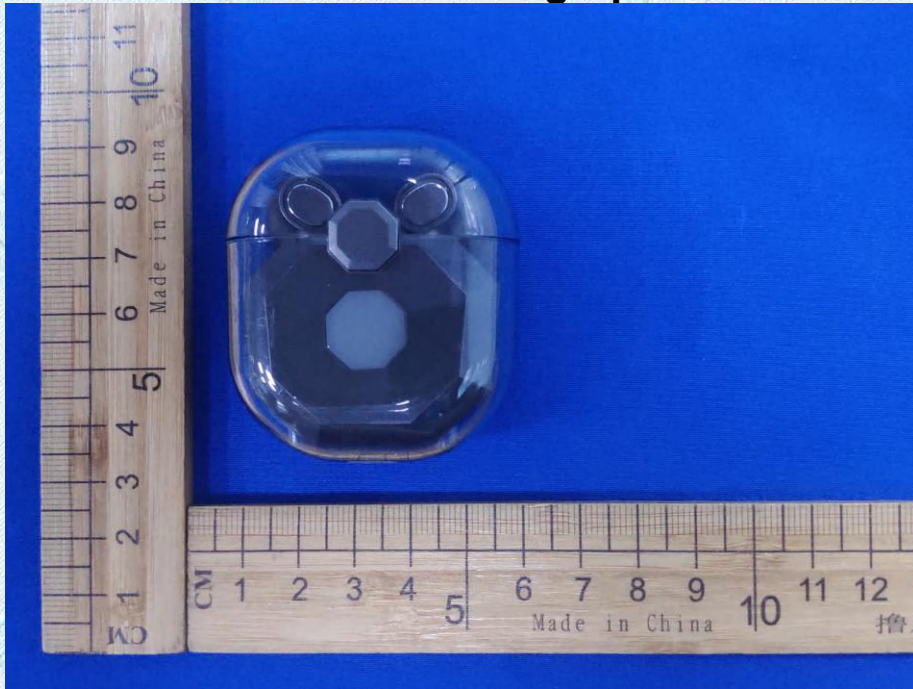

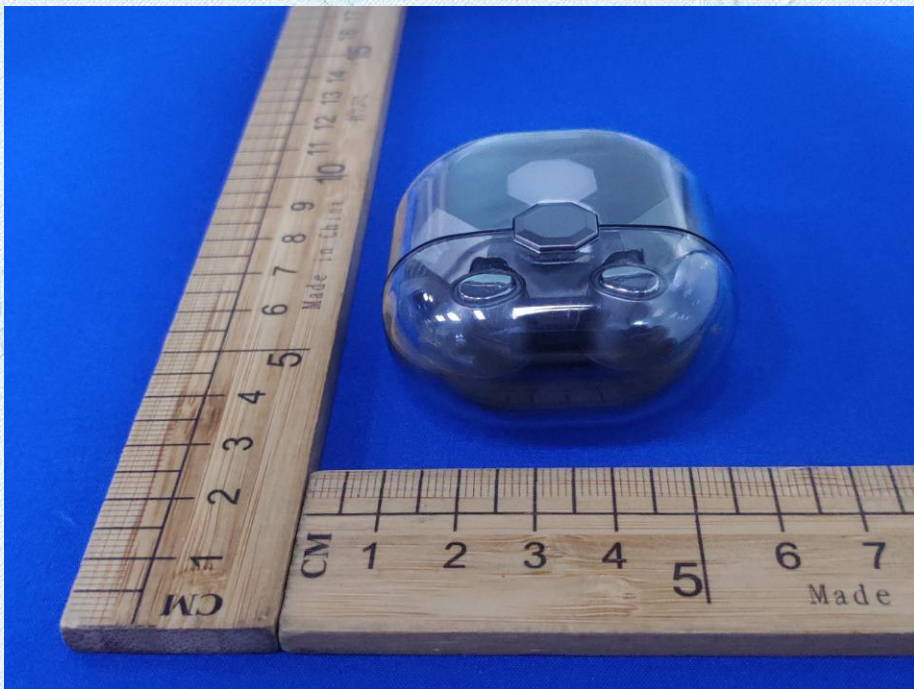
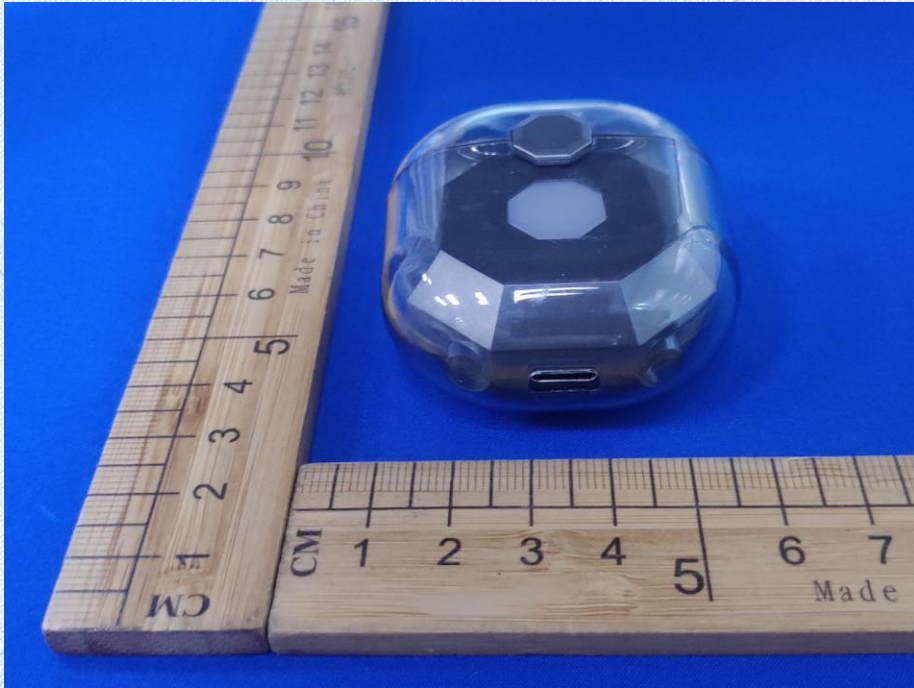

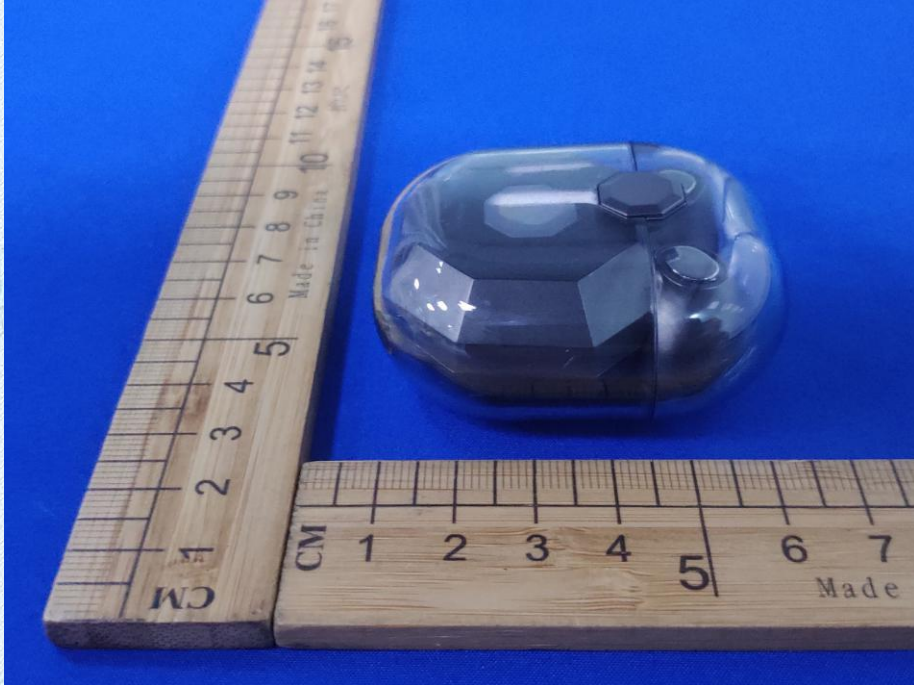
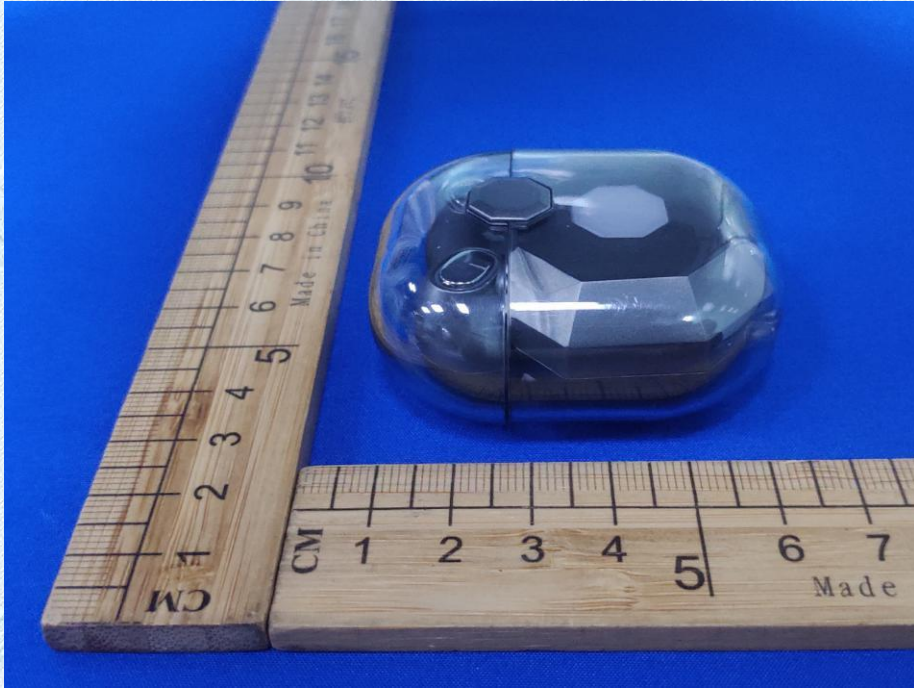

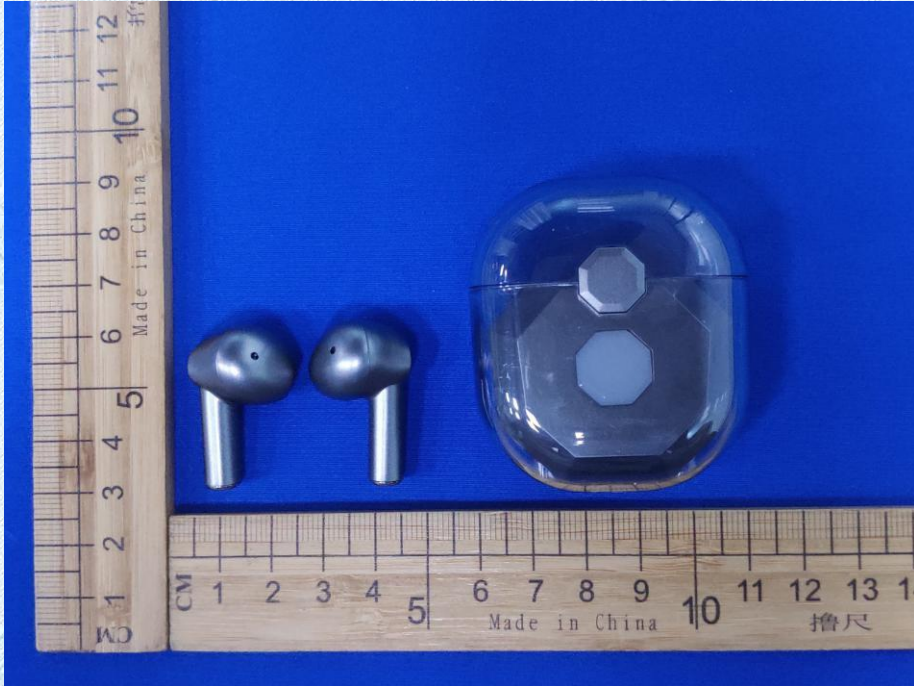

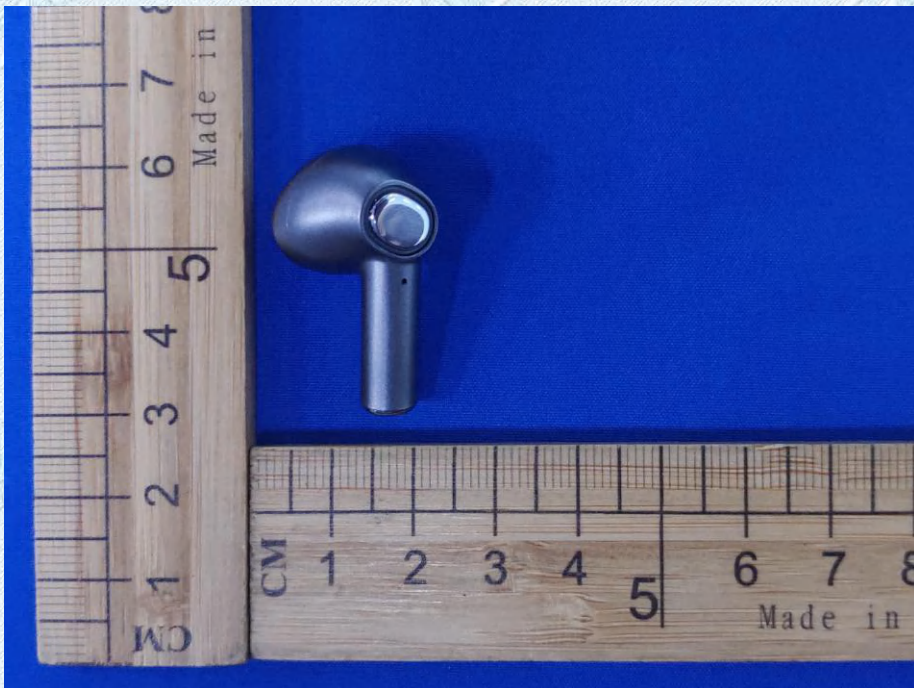
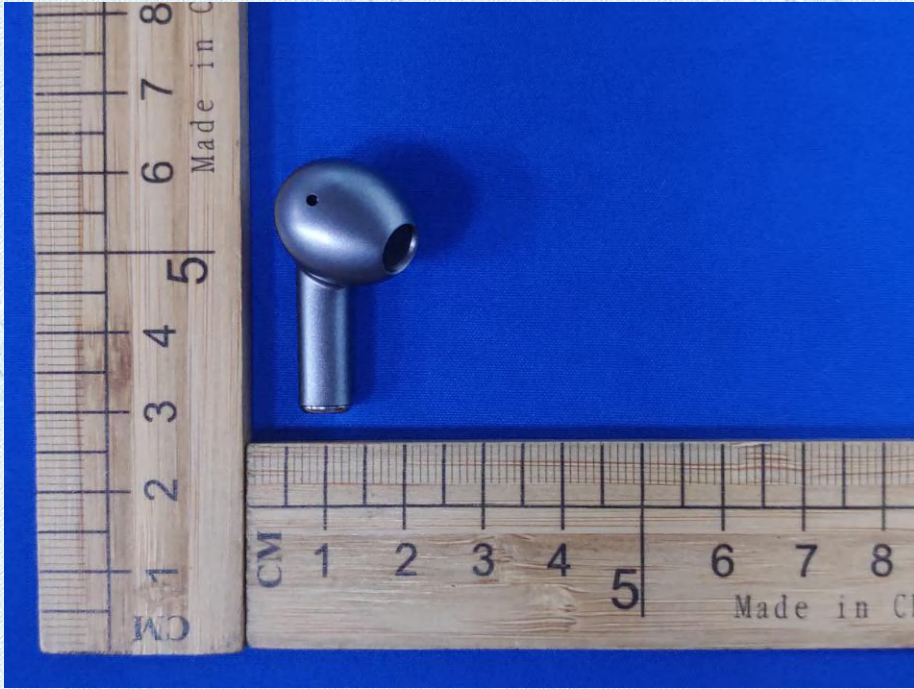

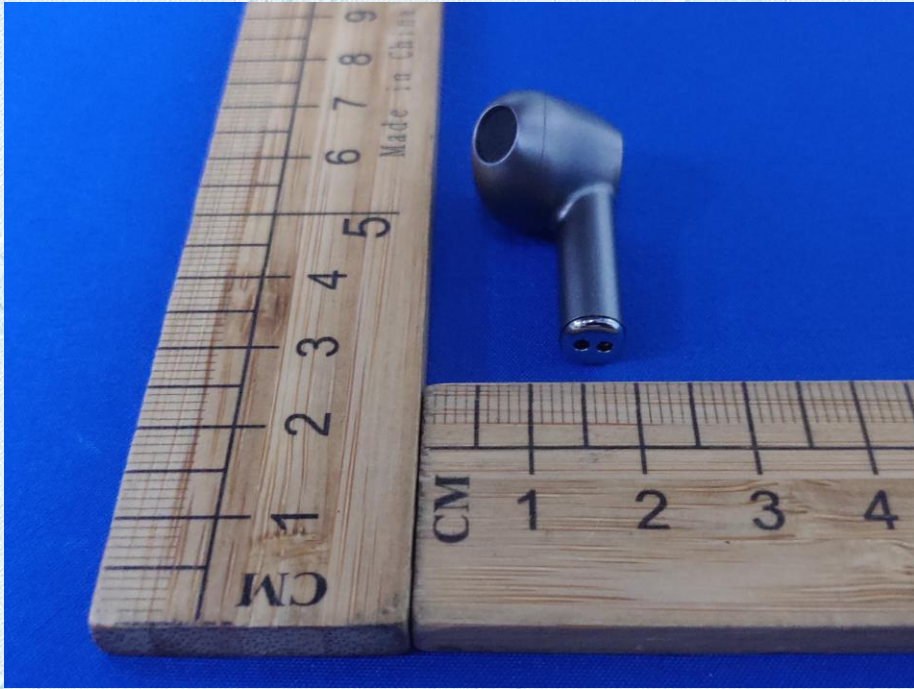



Internal photos

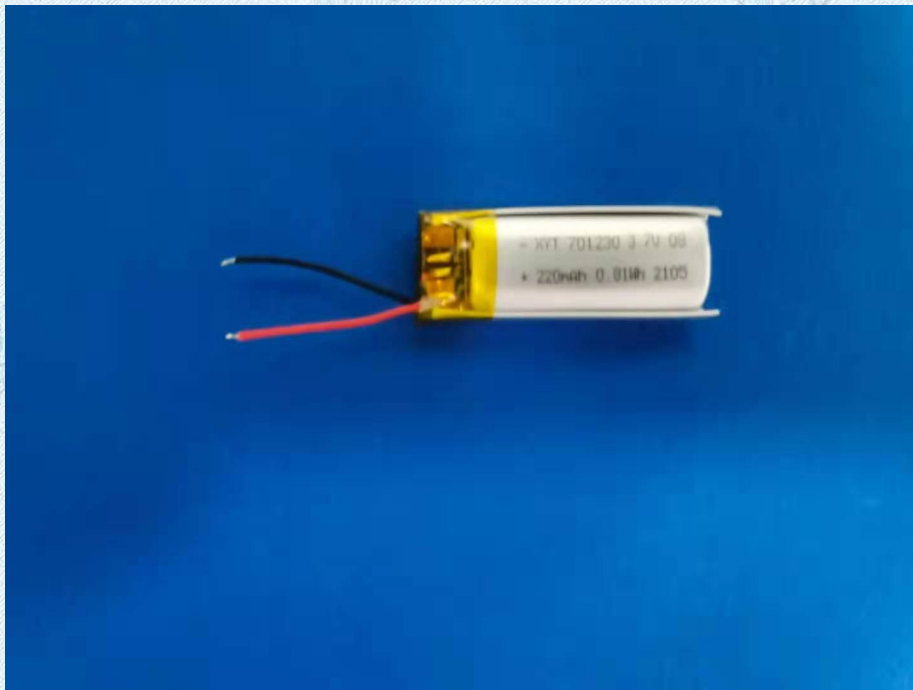

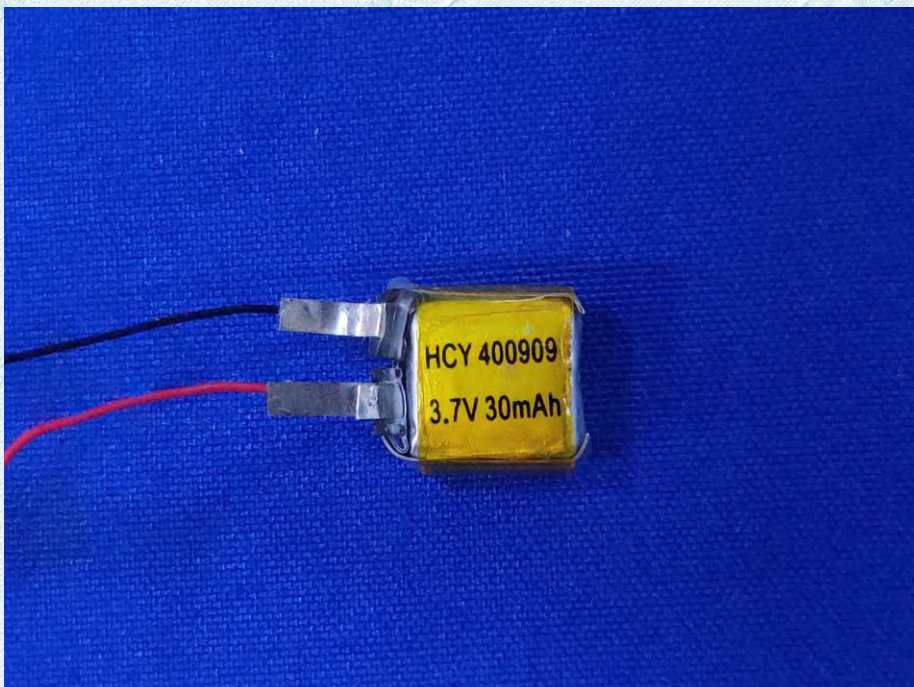
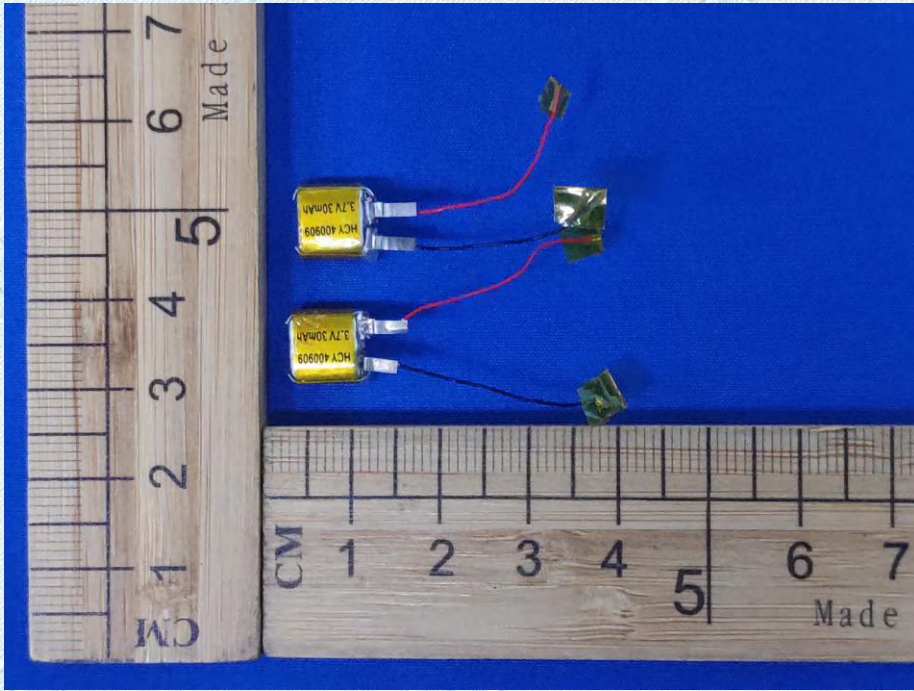

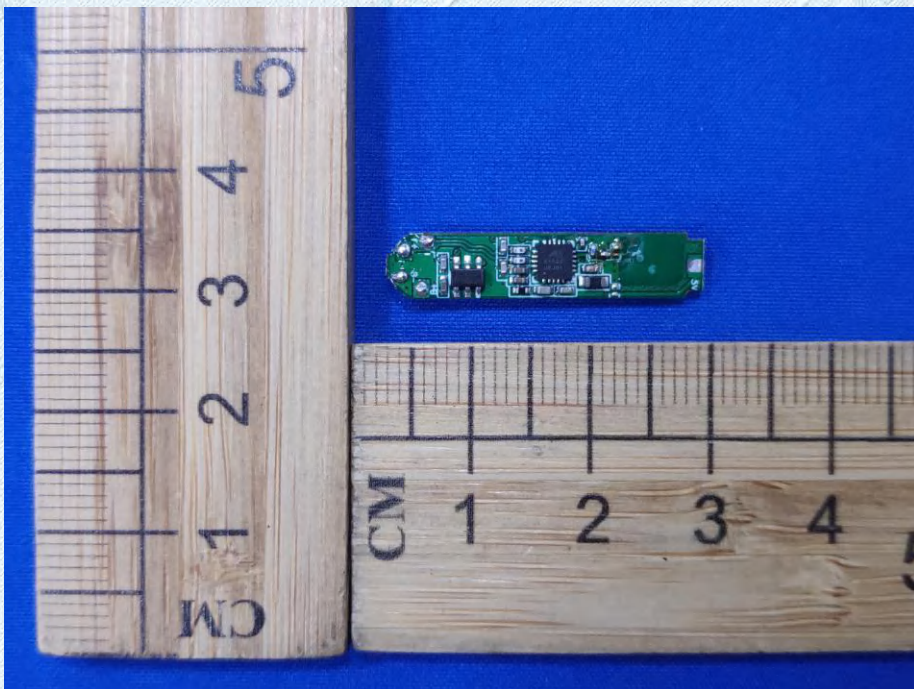

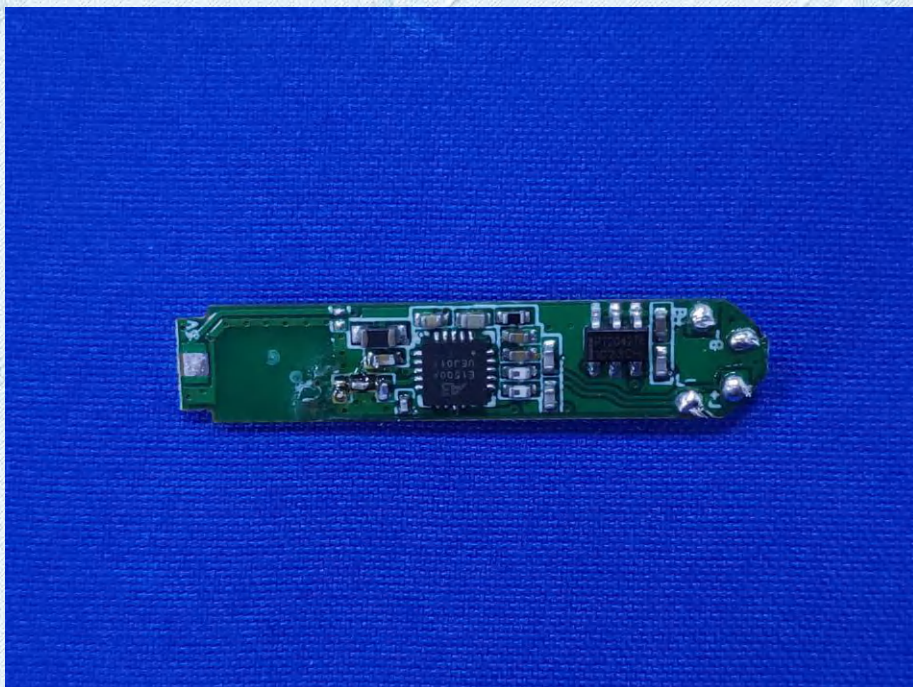
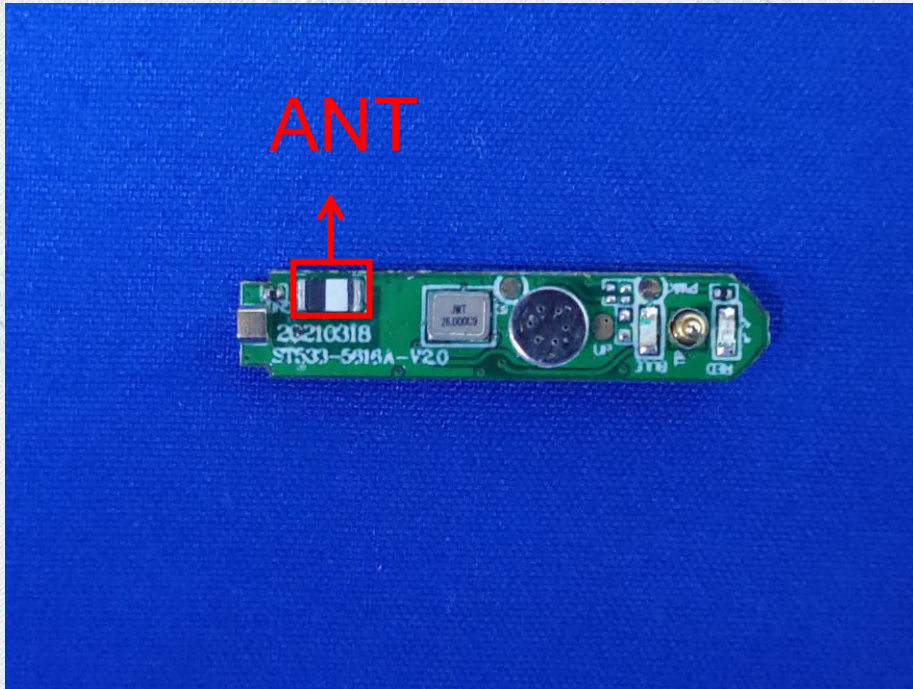

*****THE END*****