



InterLab[®]

Final Report on

Cinterion Wireless Module PXS8

Report Reference: MDE_CINTE_1203_FCC22b_V1
acc. Title 47 CFR chapter I part 22 subpart H

Date: June 27, 2012

Test Laboratory:

7Layers AG
Borsigstr. 11
40880 Ratingen
Germany



Note:
The following test results relate only to the devices specified in this document. This report shall not be reproduced in parts without the written approval of the test laboratory.

7Layers AG
Borsigstrasse 11
40880 Ratingen, Germany
Phone: +49 (0) 2102 749 0
Fax: +49 (0) 2102 749 350
www.7Layers.com

Aufsichtsratsvorsitzender •
Chairman of the Supervisory Board:
Ralf Mertens
Vorstand • Board:
Dr. H.-J. Meckelburg

Registergericht • registered in:
Düsseldorf, HRB 44096
USt-IdNr • VAT No.:
DE 203159652
TAX No. 147/5869/0385

1 Administrative Data

1.1 Project Data

Project Responsible: Mr. Pascal Jordan
Date Of Test Report: 2012/06/27
Date of first test: 2012/03/13
Date of last test: 2012/05/24

1.2 Applicant Data

Company Name: Cinterion Wireless Modules GmbH
Street: Siemensdamm 50
City: 13629 Berlin
Country: Germany
Contact Person: Mr. Thorsten Liebig
Function: Manager Approval
Department: Approvals & Standardization
Phone: +49 (30) 31102-8241
Mobile: +49 (160) 7074027
E-Mail: thorsten.liebig@cinterion.com

1.3 Test Laboratory Data

The following list shows all places and laboratories involved for test result generation:

7 layers DE

Company Name : 7 layers AG
Street : Borsigstrasse 11
City : 40880 Ratingen
Country : Germany
Contact Person : Mr. Michael Albert
Phone : +49 2102 749 201
Fax : +49 2102 749 444
E Mail : michael.albert@7Layers.de

Laboratory Details

<i>Lab ID</i>	<i>Identification</i>	<i>Responsible</i>	<i>Accreditation Info</i>
Lab 1	Radiated Emissions	Mr. Robert Machulec Mr. Andreas Petz	DAkKS-Registration no. D-PL-12140-01-01
Lab 2	Radio Lab	Mr. Robert Machulec Mr. Andreas Petz	DAkKS-Registration no. D-PL-12140-01-01



1.4 Signature of the Testing Responsible

Marco Kullik
responsible for tests performed in: Lab 1, Lab 2

1.5 Signature of the Accreditation Responsible

Accreditation scope responsible person
responsible for Lab 1, Lab 2



2 Test Object Data

2.1 General OUT Description

The following section lists all OUTs (Object's Under Test) involved during testing.

OUT: PXS8

Type / Model / Family:	Cinterion Wireless Module PXS8
Product Category:	Module
Manufacturer:	
Company Name:	Cinterion Wireless Modules GmbH
Street:	Siemensdamm 50
City:	13629 Berlin
Country:	Germany
Contact Person:	Mr. Thorsten Liebig
Function:	Manager Approval
Department:	Approvals & Standardization
Phone:	+49 (30) 31102-8241
Mobile:	+49 (160) 7074027
E-Mail:	thorsten.liebig@cinterion.com

Parameter List:

Parameter name	Value
Parameter for Scope FCC_v2:	
Antenna gain 1900 band	not specified (dBi)
Antenna gain 850 band	not specified (dBi)
DC Power Supply	4.2 (V)
highest channel	251 (848.8MHz) for GSM850, 810 (1909.8MHz) for GSM1900, 4233 (846.6MHz) for FDD5, 9538 (1907.6MHz) for FDD2, 1013 (824.7MHz) for BC0, 1175 (1908.75MHz) for BC1
lowest channel	128 (824.2MHz) for GSM850, 512 (1850.2MHz) for GSM1900, 4132 (826.4MHz) for FDD5, 262 (1852.4MHz) for FDD2, 384 (836.5MHz) for BC0, 25 (1851.25MHz) for BC1
mid channel	190 (836.6MHz) for GSM850, 661 (1880.0MHz) for GSM1900, 4183 (836.6MHz) for FDD5, 9400 (1880MHz) for FDD2, 777 (848.3MHz) for BC0, 600 (1880.0MHz) for BC1



2.2 Detailed Description of OUT Samples

Sample : b01

<i>OUT Identifier</i>	PXS8		
<i>Sample Description</i>	Sample #02		
<i>Serial No.</i>	S30960-S2600-A100-1		
<i>HW Status</i>	B2		
<i>SW Status</i>	Rev. 00.100		
<i>Date of Receipt</i>	2012/03/02		
<i>Low Voltage</i>	3.3 V	<i>Low Temp.</i>	-10 °C
<i>High Voltage</i>	4.2 V	<i>High Temp.</i>	+55 °C
<i>Nominal Voltage</i>	4.2 V	<i>Normal Temp.</i>	+23 °C

2.3 OUT Features

Features for OUT: PXS8

<i>Designation</i>	<i>Description</i>	<i>Allowed Values</i>	<i>Supported Value(s)</i>
Features for scope: FCC_v2			
AC	The OUT is powered by or connected to AC Mains		
CDMA2000_800	EUT supports CDMA2000 in band 824.7MHz - 848.3MHz (BC0)		
CDMA2000_1900	EUT supports CDMA2000 in band 1851.25MHz - 1908.75MHz (BC1)		
CDMA2000_EV-DO_800	EUT supports CDMA2000 EV-DO in band 824.7MHz - 848.3MHz (BC0)		
CDMA2000_EV-DO_1900	EUT supports CDMA2000 EV-DO in band 1851.25MHz - 1908.75MHz (BC1)		
DC	The OUT is powered by or connected to DC Mains		
EDGE850	EUT supports EDGE in the band 824 MHz - 849 MHz		
EDGE1900	EUT supports EDGE in the band 1850 MHz - 1910 MHz		
FDD2	EUT supports UMTS FDD2 in the band 1850 MHz - 1910 MHz		
FDD5	EUT supports UMTS FDD5 in the band 824 MHz - 849 MHz		
GSM850	EUT supports GSM850 band 824MHz - 849MHz		
HSDPA-FDD2	EUT supports UMTS FDD2 HSDPA in the band 1850 MHz - 1910 MHz		
HSDPA-FDD5	EUT supports UMTS FDD5 HSDPA in the band 824 MHz - 849 MHz		
HSUPA-FDD2	EUT supports UMTS FDD2 HSUPA in the band 1850 MHz - 1910 MHz		
HSUPA-FDD5	EUT supports UMTS FDD5 HSUPA in the band 824 MHz - 849 MHz		
PantC	permanent fixed antenna connector, which may be built-in, designed as an indispensable part of the equipment		
PCS1900	EUT supports PCS1900 band 1850MHz - 1910MHz		

2.4 Auxiliary Equipment

<i>AE No.</i>	<i>Type Designation</i>	<i>Serial No.</i>	<i>HW Status</i>	<i>SW Status</i>	<i>Description</i>
AE 02	-	-	-	-	Flex cable
AE Ant1	-	-	-	-	GSM/UMTS antenna
AE 03	-	-	-	-	Shielded housing
AE Ant2	-	-	-	-	UMTS antenna
AE Ant3	ANN-MS-0-005	601657	-	-	GPS antenna
AE 01	M827B DSB75_B1.1_0152	-	-	-	Evaluation board



2.5 Setups used for Testing

For each setup a relation is given to determine if and which samples and auxiliary equipment is used. The left side list all OUT samples and the right side lists all auxiliary equipment for the given setup.

<i>Setup No.</i>	<i>List of OUT samples</i>	<i>List of auxiliary equipment</i>	
<i>Sample No.</i>	<i>Sample Description</i>	<i>AE No.</i>	<i>AE Description</i>
B01_cond (Conducted setup #02)			
<i>Sample: b01</i>	Sample #02	AE 02	Flex cable
		AE 01	Evaluation board
B01_rad (Radiated setup #01)			
<i>Sample: b01</i>	Sample #02	AE 02	Flex cable
		AE Ant1	GSM/UMTS antenna
		AE 03	Shielded housing
		AE Ant2	UMTS antenna
		AE Ant3	GPS antenna
		AE 01	Evaluation board

3 Results

3.1 General

Documentation of tested devices:

Available at the test laboratory.

Interpretation of the test results:

The results of the inspection are described on the following pages, where 'Conformity' or 'Passed' means that the certification criteria were verified and that the tested device is conform to the applied standard.

In cases where 'Declaration' is printed, the required documents are available in the manufacturers product documentation.

In cases where 'not applicable' is printed, the test case requirements are not relevant to the specific equipment implementation.

Note:

This Test Report replaces the Test Report MDE_CINTE_1203_FCCa.

3.2 List of the Applicable Body

(Body for Scope: FCC_v2)

<i>Designation</i>	<i>Description</i>
FCC47CFRChIPART22PUBLIC MOBILE SERVICES	Part 22, Subpart H - Cellular Radiotelephone Service



Reference: MDE_CINTE_1203_FCC22b_V1

acc. Title 47 CFR chapter I part 22 subpart H

3.3 List of Test Specification

Test Specification: **FCC part 2 and 22**
Version 10-1-11 Edition
Title: PART 2 - GENERAL RULES AND REGULATIONS
PART 22 - PUBLIC MOBILE SERVICES



3.4 Summary

<i>Test Case Identifier / Name Test (condition)</i>	<i>Result</i>	<i>Date of Test</i>	<i>Lab Ref.</i>	<i>Setup</i>
22.1 RF Power Output §2.1046, §22.913				
22.1; Frequency Band = BC0, Mode = CDMA2000, Channel = 1013, Frequency = 824.7MHz, Method = conducted	Passed	2012/04/17	Lab 2	B01_cond
22.1; Frequency Band = BC0, Mode = CDMA2000, Channel = 1013, Frequency = 824.7MHz, Method = radiated	Passed	2012/04/27	Lab 1	B01_rad
22.1; Frequency Band = BC0, Mode = CDMA2000, Channel = 384, Frequency = 836.5MHz, Method = conducted	Passed	2012/04/17	Lab 2	B01_cond
22.1; Frequency Band = BC0, Mode = CDMA2000, Channel = 384, Frequency = 836.5MHz, Method = radiated	Passed	2012/04/27	Lab 1	B01_rad
22.1; Frequency Band = BC0, Mode = CDMA2000, Channel = 777, Frequency = 848.3MHz, Method = conducted	Passed	2012/04/17	Lab 2	B01_cond
22.1; Frequency Band = BC0, Mode = CDMA2000, Channel = 777, Frequency = 848.3MHz, Method = radiated	Passed	2012/04/27	Lab 1	B01_rad
22.1; Frequency Band = BC0, Mode = CDMA2000_EV-DO, Channel = 1013, Frequency = 824.7MHz, Method = conducted	Passed	2012/04/17	Lab 2	B01_cond
22.1; Frequency Band = BC0, Mode = CDMA2000_EV-DO, Channel = 1013, Frequency = 824.7MHz, Method = radiated	Passed	2012/05/24	Lab 1	B01_rad
22.1; Frequency Band = BC0, Mode = CDMA2000_EV-DO, Channel = 384, Frequency = 836.5MHz, Method = conducted	Passed	2012/04/17	Lab 2	B01_cond
22.1; Frequency Band = BC0, Mode = CDMA2000_EV-DO, Channel = 384, Frequency = 836.5MHz, Method = radiated	Passed	2012/05/24	Lab 1	B01_rad
22.1; Frequency Band = BC0, Mode = CDMA2000_EV-DO, Channel = 777, Frequency = 848.3MHz, Method = conducted	Passed	2012/04/17	Lab 2	B01_cond
22.1; Frequency Band = BC0, Mode = CDMA2000_EV-DO, Channel = 777, Frequency = 848.3MHz, Method = radiated	Passed	2012/05/24	Lab 1	B01_rad
22.2 Frequency stability §2.1055				
22.2; Frequency Band = BC0, Mode = CDMA2000, Channel = 384, Frequency = 836.5MHz	Passed	2012/04/18	Lab 2	B01_cond
22.2; Frequency Band = BC0, Mode = CDMA2000_EV-DO, Channel = 384, Frequency = 836.5MHz	Passed	2012/04/18	Lab 2	B01_cond



<i>Test Case Identifier / Name</i> <i>Test (condition)</i>	<i>Result</i>	<i>Date of Test</i>	<i>Ref.</i>	<i>Setup</i>
22.3 Spurious emissions at antenna terminals §2.1051, §22.917				
22.3; Frequency Band = BC0, Mode = CDMA2000, Channel = 1013, Frequency = 824.7MHz	Passed	2012/04/17	Lab 2	B01_cond
22.3; Frequency Band = BC0, Mode = CDMA2000, Channel = 384, Frequency = 836.5MHz	Passed	2012/04/17	Lab 2	B01_cond
22.3; Frequency Band = BC0, Mode = CDMA2000, Channel = 777, Frequency = 848.3MHz	Passed	2012/04/17	Lab 2	B01_cond
22.3; Frequency Band = BC0, Mode = CDMA2000_EV-DO, Channel = 1013, Frequency = 824.7MHz	Passed	2012/04/17	Lab 2	B01_cond
22.3; Frequency Band = BC0, Mode = CDMA2000_EV-DO, Channel = 384, Frequency = 836.5MHz	Passed	2012/04/17	Lab 2	B01_cond
22.3; Frequency Band = BC0, Mode = CDMA2000_EV-DO, Channel = 777, Frequency = 848.3MHz	Passed	2012/04/17	Lab 2	B01_cond
22.4 Field strength of spurious radiation §2.1053, §22.917				
22.4; Frequency Band = BC0, Mode = CDMA2000, Channel = 1013, Frequency = 824.7MHz	Passed	2012/03/20	Lab 1	B01_rad
22.4; Frequency Band = BC0, Mode = CDMA2000, Channel = 384, Frequency = 836.5MHz	Passed	2012/03/20	Lab 1	B01_rad
22.4; Frequency Band = BC0, Mode = CDMA2000, Channel = 777, Frequency = 848.3MHz	Passed	2012/04/25	Lab 1	B01_rad
22.4; Frequency Band = BC0, Mode = CDMA2000_EV-DO, Channel = 1013, Frequency = 824.7MHz	Passed	2012/03/13	Lab 1	B01_rad
22.4; Frequency Band = BC0, Mode = CDMA2000_EV-DO, Channel = 384, Frequency = 836.5MHz	Passed	2012/03/13	Lab 1	B01_rad
22.4; Frequency Band = BC0, Mode = CDMA2000_EV-DO, Channel = 777, Frequency = 848.3MHz	Passed	2012/03/13	Lab 1	B01_rad
22.5 Emission and Occupied Bandwidth §2.1049, §22.917				
22.5; Frequency Band = BC0, Mode = CDMA2000_EV-DO; Channel = 777, Frequency = 848.3MHz	Passed	2012/04/17	Lab 2	B01_cond
22.5; Frequency Band = BC0, Mode = CDMA2000, Channel = 1013, Frequency = 824.7MHz	Passed	2012/04/17	Lab 2	B01_cond
22.5; Frequency Band = BC0, Mode = CDMA2000, Channel = 384 Frequency = 836.5MHz	Passed	2012/04/17	Lab 2	B01_cond
22.5; Frequency Band = BC0, Mode = CDMA2000, Channel = 777, Frequency = 848.3MHz	Passed	2012/04/17	Lab 2	B01_cond
22.5; Frequency Band = BC0, Mode = CDMA2000_EV-DO, Channel = 1013, Frequency = 824.7MHz	Passed	2012/04/17	Lab 2	B01_cond
22.5; Frequency Band = BC0, Mode = CDMA2000_EV-DO, Channel = 384 Frequency = 836.5MHz	Passed	2012/04/17	Lab 2	B01_cond



Reference: MDE_CINTE_1203_FCC22b_V1

acc. Title 47 CFR chapter I part 22 subpart H
Lab

<i>Test Case Identifier / Name</i> <i>Test (condition)</i>	<i>Result</i>	<i>Date of Test</i>	<i>Ref.</i>	<i>Setup</i>
22.6 Band edge compliance §2.1053, §22.917				
22.6; Frequency Band = BC0, Mode = CDMA2000, Channel = 1013, Frequency = 824.7MHz	Passed	2012/04/17	Lab 2	B01_cond
22.6; Frequency Band = BC0, Mode = CDMA2000, Channel = 777, Frequency = 848.3MHz	Passed	2012/04/17	Lab 2	B01_cond
22.6; Frequency Band = BC0, Mode = CDMA2000_EV-DO, Channel = 1013, Frequency = 824.7MHz	Passed	2012/04/17	Lab 2	B01_cond
22.6; Frequency Band = BC0, Mode = CDMA2000_EV-DO, Channel = 777, Frequency = 848.3MHz	Passed	2012/04/17	Lab 2	B01_cond



3.5 Detailed Results

3.5.1 22.1 RF Power Output §2.1046, §22.913

Test: 22.1; Frequency Band = BC0, Mode = CDMA2000, Channel = 1013, Frequency = 824.7MHz, Method = conducted

<i>Result:</i>	Passed
<i>Setup No.:</i>	B01_cond
<i>Date of Test:</i>	2012/04/17 13:40
<i>Body:</i>	FCC47CFRChIPART22PUBLIC MOBILE SERVICES
<i>Test Specification:</i>	FCC part 2 and 22

Detailed Results:

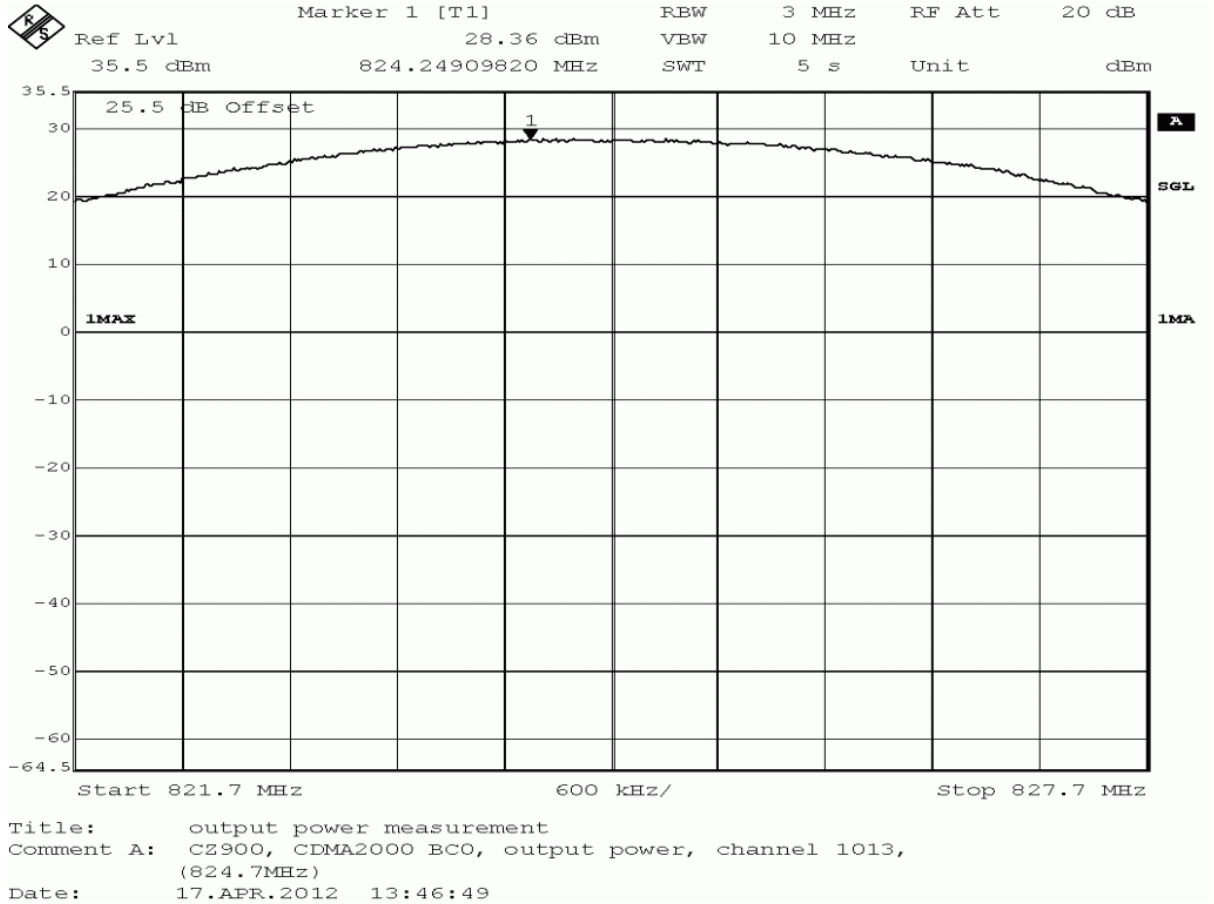



detector	trace	resolution bandwidth /kHz	conducted power /dBm	limit /dBm	margin /dB	verdict
peak	maxhold	3000	28.4	38.45	10.1	passed
average	maxhold	3000	22.7	38.45	15.8	passed
rms	maxhold	3000	23.1	38.45	15.4	passed

no external antenna gain is specified, the verdict is valid for the gain of an external antenna equal or less than 12.2 dBi (related to peak-value, worst-case)

Test: 22.1; Frequency Band = BC0, Mode = CDMA2000, Channel = 1013, Frequency = 824.7MHz, Method = radiated

Result: Passed
Setup No.: B01_rad
Date of Test: 2012/04/27 18:39
Body: FCC47CFRChIPART22PUBLIC MOBILE SERVICES
Test Specification: FCC part 2 and 22

Detailed Results:

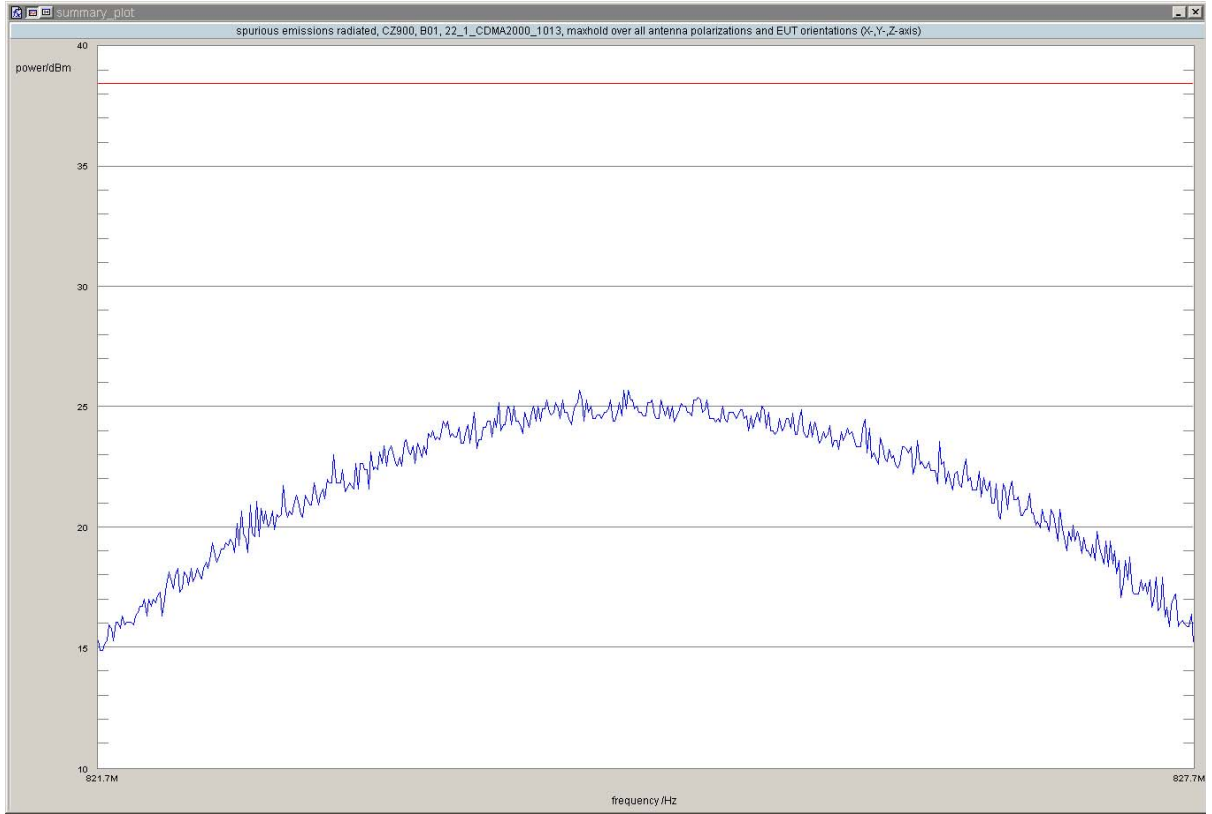

detector	trace	resolution bandwidth /kHz	frequency /MHz	peak value /dBm	limit /dBm	margin to limit /dB	azimuth /°	antenna polarization	EUT orientation	verdict
peak	maxhold	3000	824.3	25.69	38.45	12.76	30.0	vertical	horizontal	passed

no further values have been found with a margin of less than 20 dB

Test: 22.1; Frequency Band = BC0, Mode = CDMA2000, Channel = 384, Frequency = 836.5MHz, Method = conducted

Result: Passed

Setup No.: B01_cond

Date of Test: 2012/04/17 13:37

Body: FCC47CFRChIPART22PUBLIC MOBILE SERVICES

Test Specification: FCC part 2 and 22

Detailed Results:

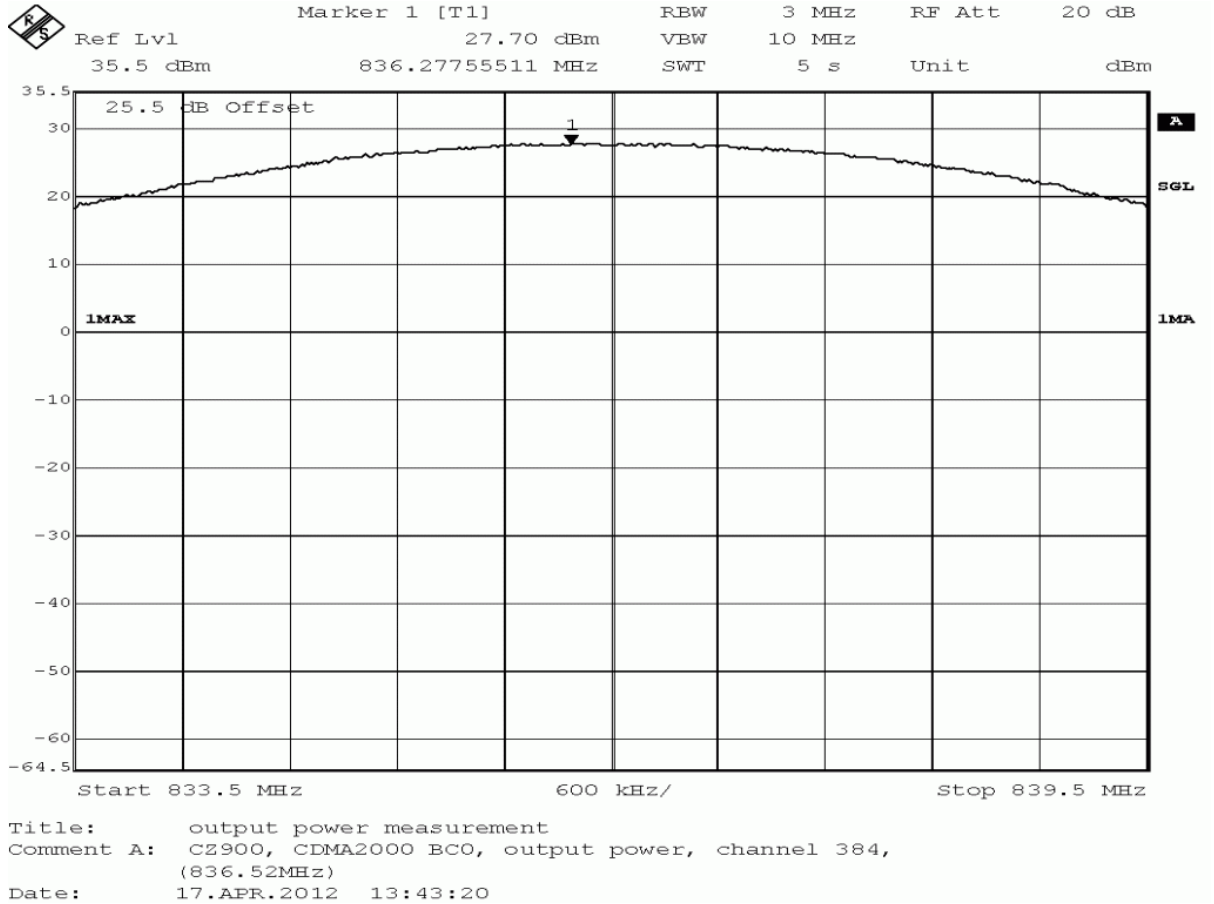



detector	trace	resolution bandwidth /kHz	conducted power /dBm	limit /dBm	margin /dB	verdict
peak	maxhold	3000	27.7	38.45	10.8	passed
average	maxhold	3000	22.5	38.45	15.9	passed
rms	maxhold	3000	22.8	38.45	15.6	passed

no external antenna gain is specified, the verdict is valid for the gain of an external antenna equal or less than 12.9 dBi (related to peak-value, worst-case)

Test: 22.1; Frequency Band = BC0, Mode = CDMA2000, Channel = 384, Frequency = 836.5MHz, Method = radiated

Result: Passed
Setup No.: B01_rad
Date of Test: 2012/04/27 17:55
Body: FCC47CFRChIPART22PUBLIC MOBILE SERVICES
Test Specification: FCC part 2 and 22

Detailed Results:

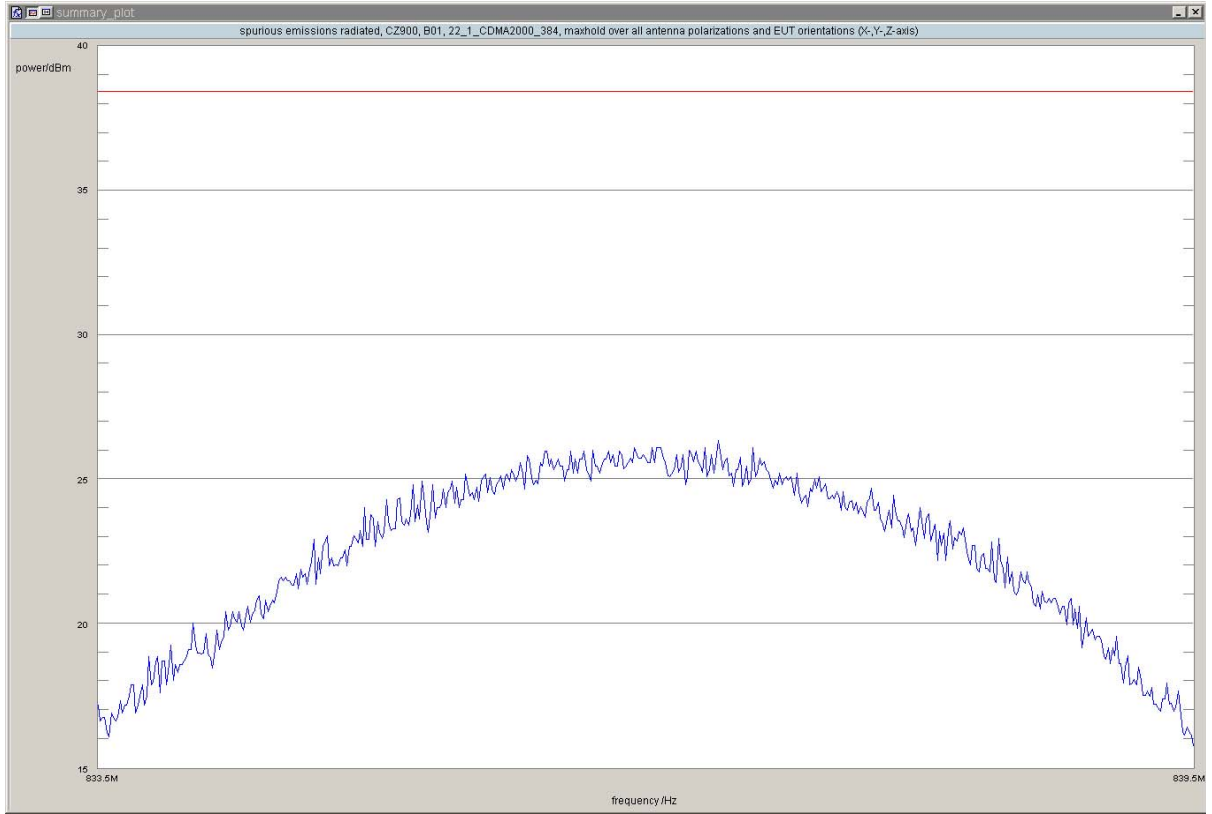

detector	trace	resolution bandwidth /kHz	frequency /MHz	peak value /dBm	limit /dBm	margin to limit /dB	azimuth /°	antenna polarization	EUT orientation	verdict
peak	maxhold	3000	836.9	26.35	38.45	12.10	30.0	vertical	horizontal	passed

no further values have been found with a margin of less than 20 dB

Test: 22.1; Frequency Band = BC0, Mode = CDMA2000, Channel = 777, Frequency = 848.3MHz, Method = conducted

Result: Passed

Setup No.: B01_cond

Date of Test: 2012/04/17 13:35

Body: FCC47CFRChIPART22PUBLIC MOBILE SERVICES

Test Specification: FCC part 2 and 22

Detailed Results:

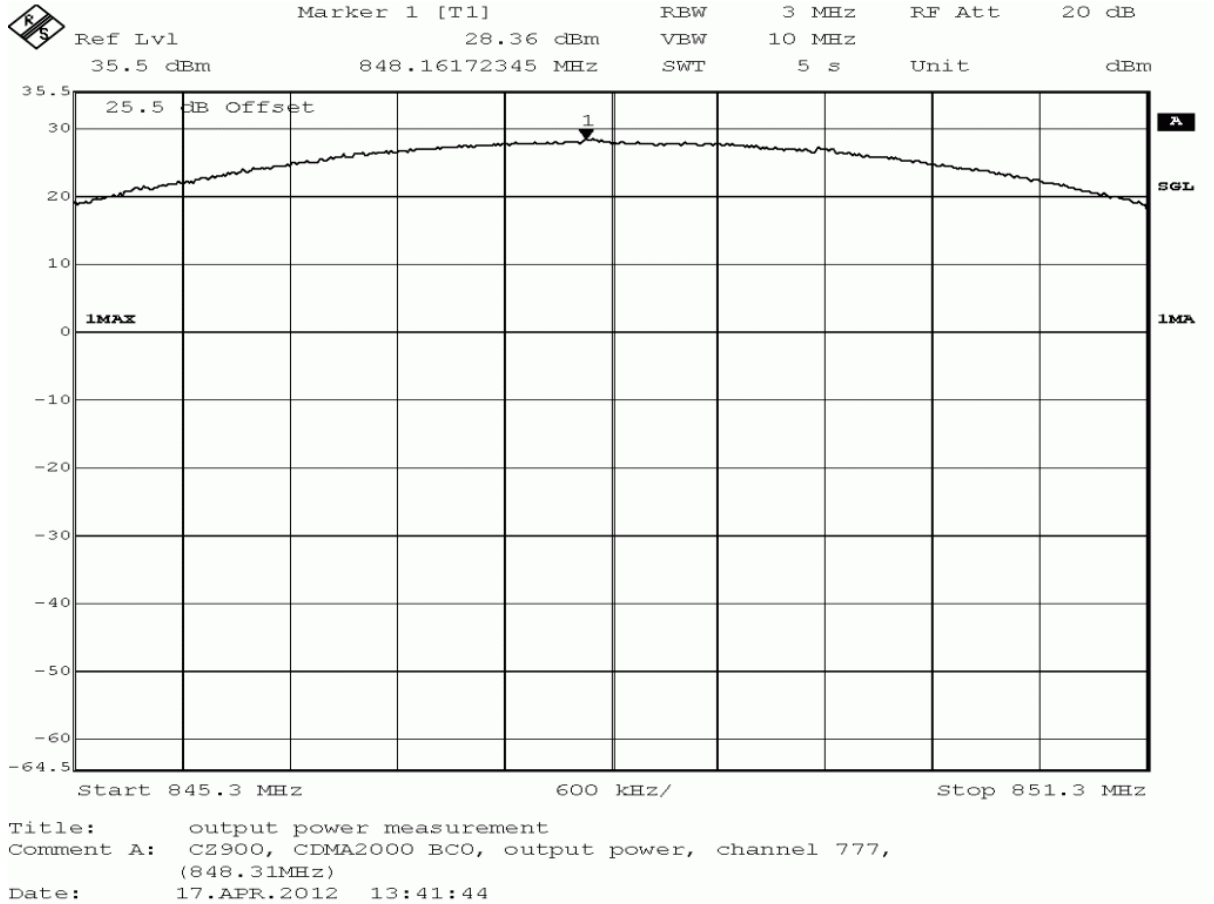



detector	trace	resolution bandwidth /kHz	conducted power /dBm	limit /dBm	margin /dB	verdict
peak	maxhold	3000	28.4	38.45	10.1	passed
average	maxhold	3000	22.4	38.45	16.1	passed
rms	maxhold	3000	22.6	38.45	15.8	passed

no external antenna gain is specified, the verdict is valid for the gain of an external antenna equal or less than 12.2 dBi (related to peak-value, worst-case)

Test: 22.1; Frequency Band = BC0, Mode = CDMA2000, Channel = 777, Frequency = 848.3MHz, Method = radiated

Result: Passed
Setup No.: B01_rad
Date of Test: 2012/04/27 18:16
Body: FCC47CFRChIPART22PUBLIC MOBILE SERVICES
Test Specification: FCC part 2 and 22

Detailed Results:

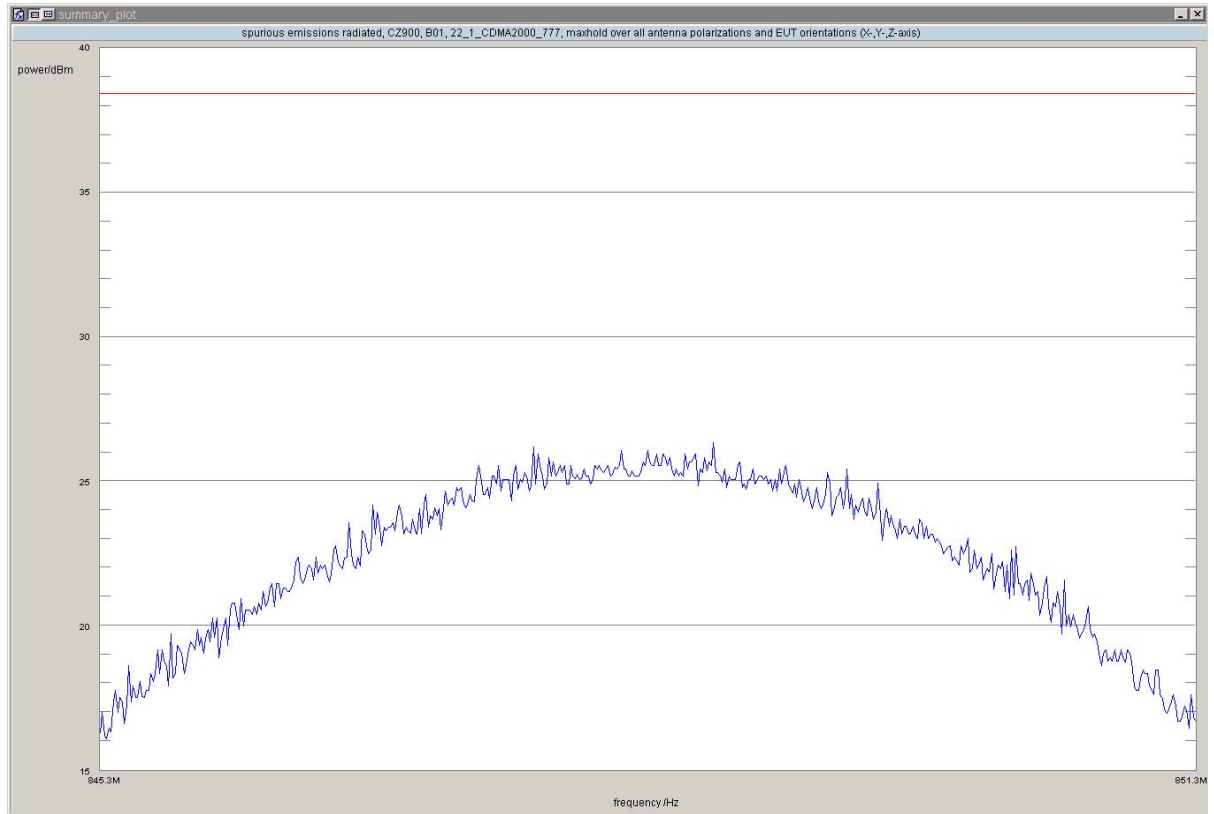

detector	trace	resolution bandwidth /kHz	frequency /MHz	peak value /dBm	limit /dBm	margin to limit /dB	azimuth /°	antenna polarization	EUT orientation	verdict
peak	maxhold	3000	848.7	26.33	38.45	12.12	90.0	horizontal	vertical	passed

no further values have been found with a margin of less than 20 dB

Test: 22.1; Frequency Band = BC0, Mode = CDMA2000_EV-DO, Channel = 1013, Frequency = 824.7MHz, Method = conducted

Result: Passed

Setup No.: B01_cond

Date of Test: 2012/04/17 14:12

Body: FCC47CFRChIPART22PUBLIC MOBILE SERVICES

Test Specification: FCC part 2 and 22

Detailed Results:

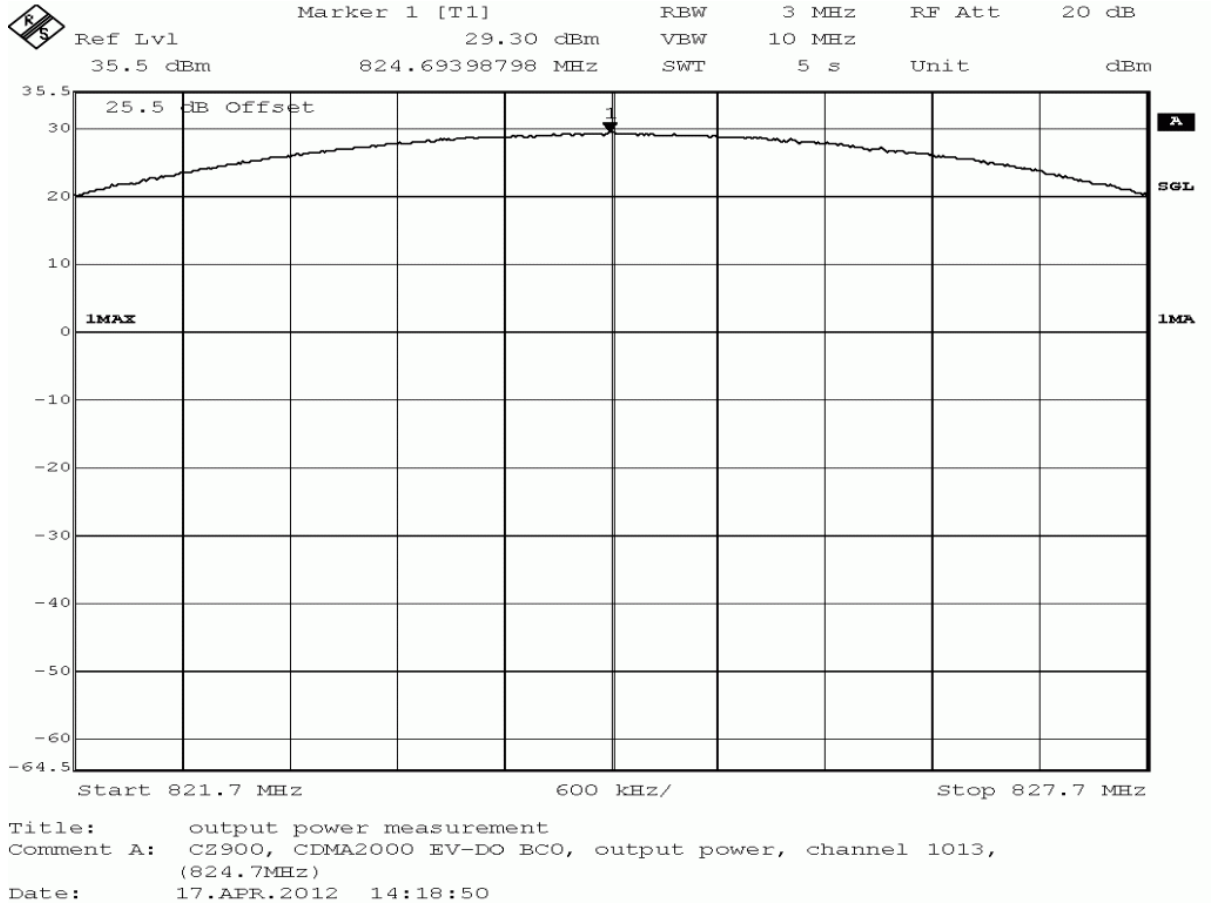



detector	trace	resolution bandwidth /kHz	conducted power /dBm	limit /dBm	margin /dB	verdict
peak	maxhold	3000	29.3	38.45	9.2	passed
average	maxhold	3000	22.4	38.45	16.0	passed
rms	maxhold	3000	23.0	38.45	15.4	passed

no external antenna gain is specified, the verdict is valid for the gain of an external antenna equal or less than 11.3 dBi (related to peak-value, worst-case)

Test: 22.1; Frequency Band = BC0, Mode = CDMA2000_EV-DO, Channel = 1013, Frequency = 824.7MHz, Method = radiated

Result: Passed
Setup No.: B01_rad
Date of Test: 2012/05/24 11:44
Body: FCC47CFRChIPART22PUBLIC MOBILE SERVICES
Test Specification: FCC part 2 and 22

Detailed Results:

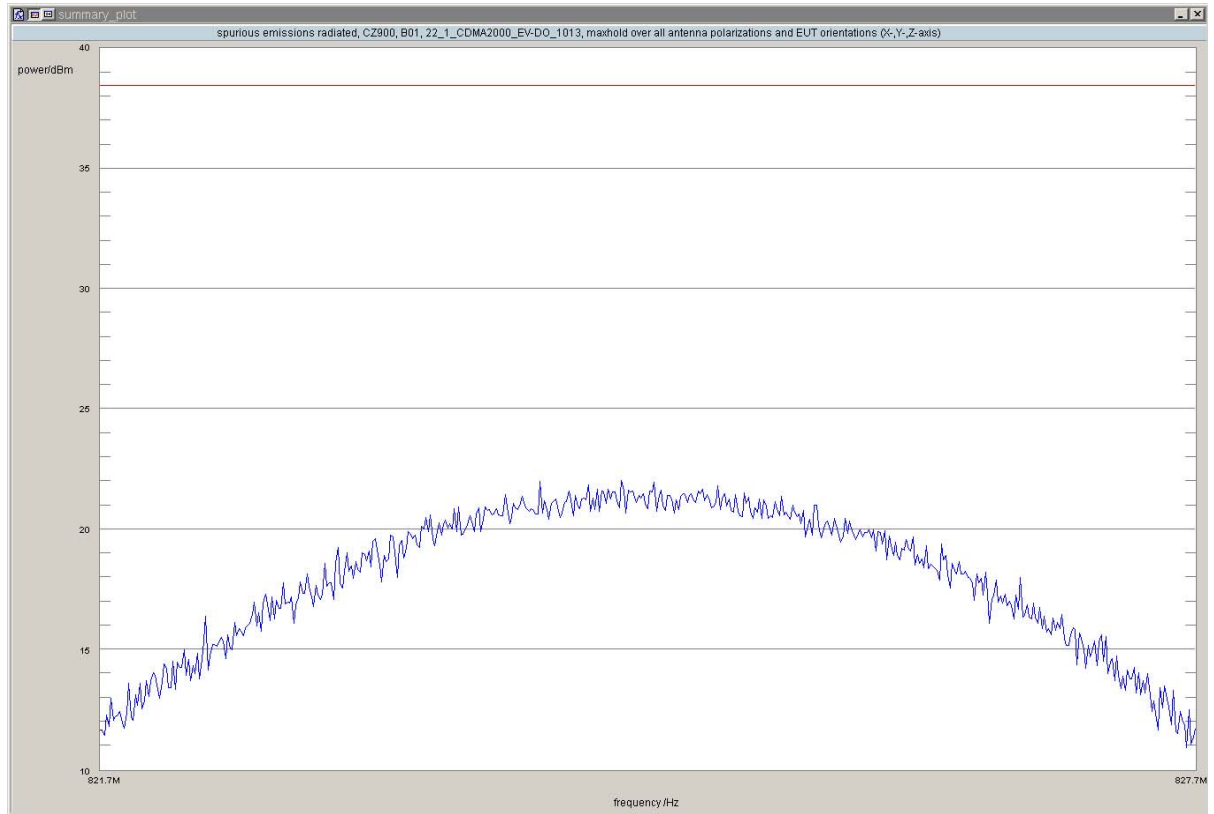

detector	trace	resolution bandwidth /kHz	frequency /MHz	peak value /dBm	limit /dBm	margin to limit /dB	azimuth /°	antenna polarization	EUT orientation	verdict
rms	maxhold	3000	824.5	22.01	38.45	16.44	90.0	horizontal	vertical	passed

no further values have been found with a margin of less than 20 dB

Test: 22.1; Frequency Band = BC0, Mode = CDMA2000_EV-DO, Channel = 384, Frequency = 836.5MHz, Method = conducted

Result: Passed

Setup No.: B01_cond

Date of Test: 2012/04/17 14:30

Body: FCC47CFRChIPART22PUBLIC MOBILE SERVICES

Test Specification: FCC part 2 and 22

Detailed Results:

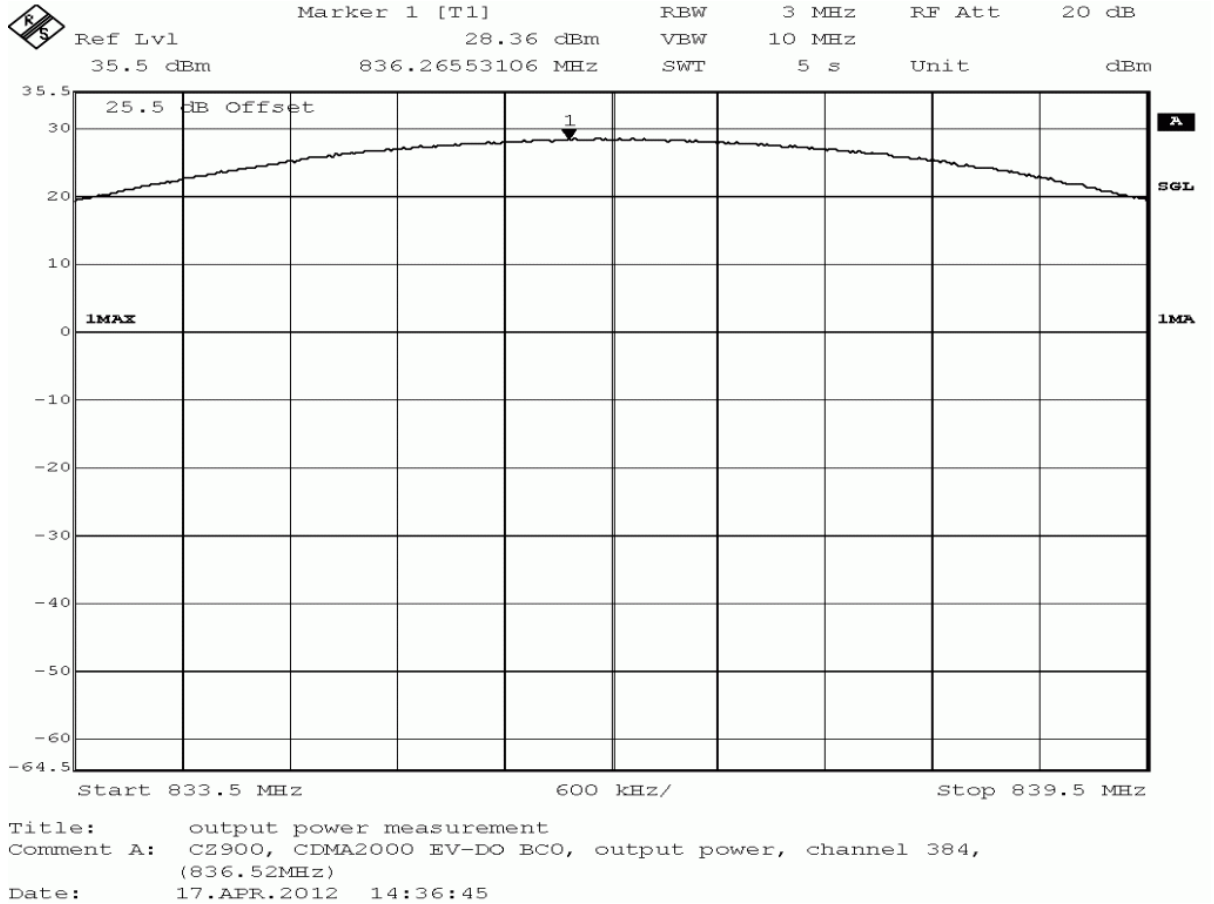



detector	trace	resolution bandwidth /kHz	conducted power /dBm	limit /dBm	margin /dB	verdict
peak	maxhold	3000	28.4	38.45	10.1	passed
average	maxhold	3000	22.2	38.45	16.3	passed
rms	maxhold	3000	22.8	38.45	15.6	passed

no external antenna gain is specified, the verdict is valid for the gain of an external antenna equal or less than 12.2 dBi (related to peak-value, worst-case)

Test: 22.1; Frequency Band = BC0, Mode = CDMA2000_EV-DO, Channel = 384, Frequency = 836.5MHz, Method = radiated

Result: Passed
Setup No.: B01_rad
Date of Test: 2012/05/24 12:17
Body: FCC47CFRChIPART22PUBLIC MOBILE SERVICES
Test Specification: FCC part 2 and 22

Detailed Results:

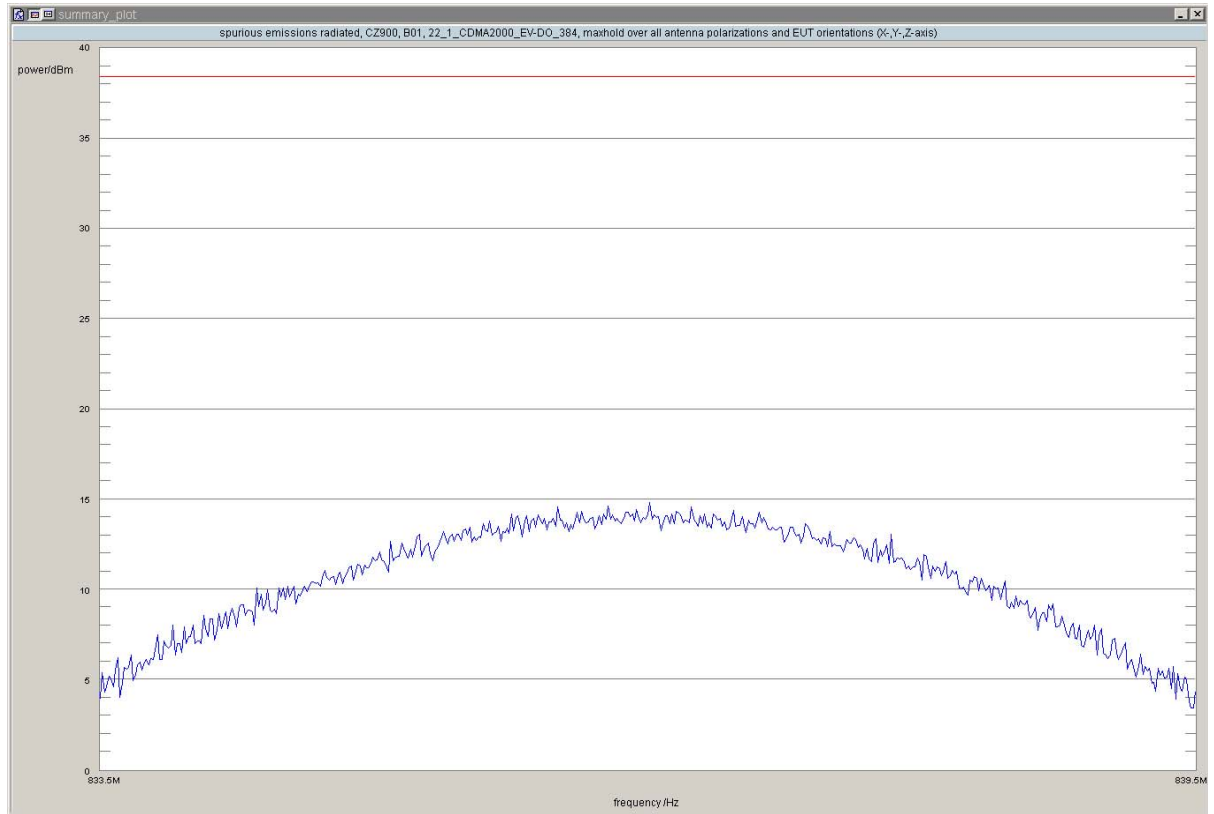

detector	trace	resolution bandwidth /kHz	frequency /MHz	peak value /dBm	limit /dBm	margin to limit /dB	azimuth /°	antenna polarization	EUT orientation	verdict
rms	maxhold	3000	836.5	14.82	38.45	23.63	90.0	horizontal	vertical	passed

no further values have been found with a margin of less than 20 dB

Test: 22.1; Frequency Band = BC0, Mode = CDMA2000_EV-DO, Channel = 777, Frequency = 848.3MHz, Method = conducted

Result: Passed

Setup No.: B01_cond

Date of Test: 2012/04/17 14:18

Body: FCC47CFRChIPART22PUBLIC MOBILE SERVICES

Test Specification: FCC part 2 and 22

Detailed Results:

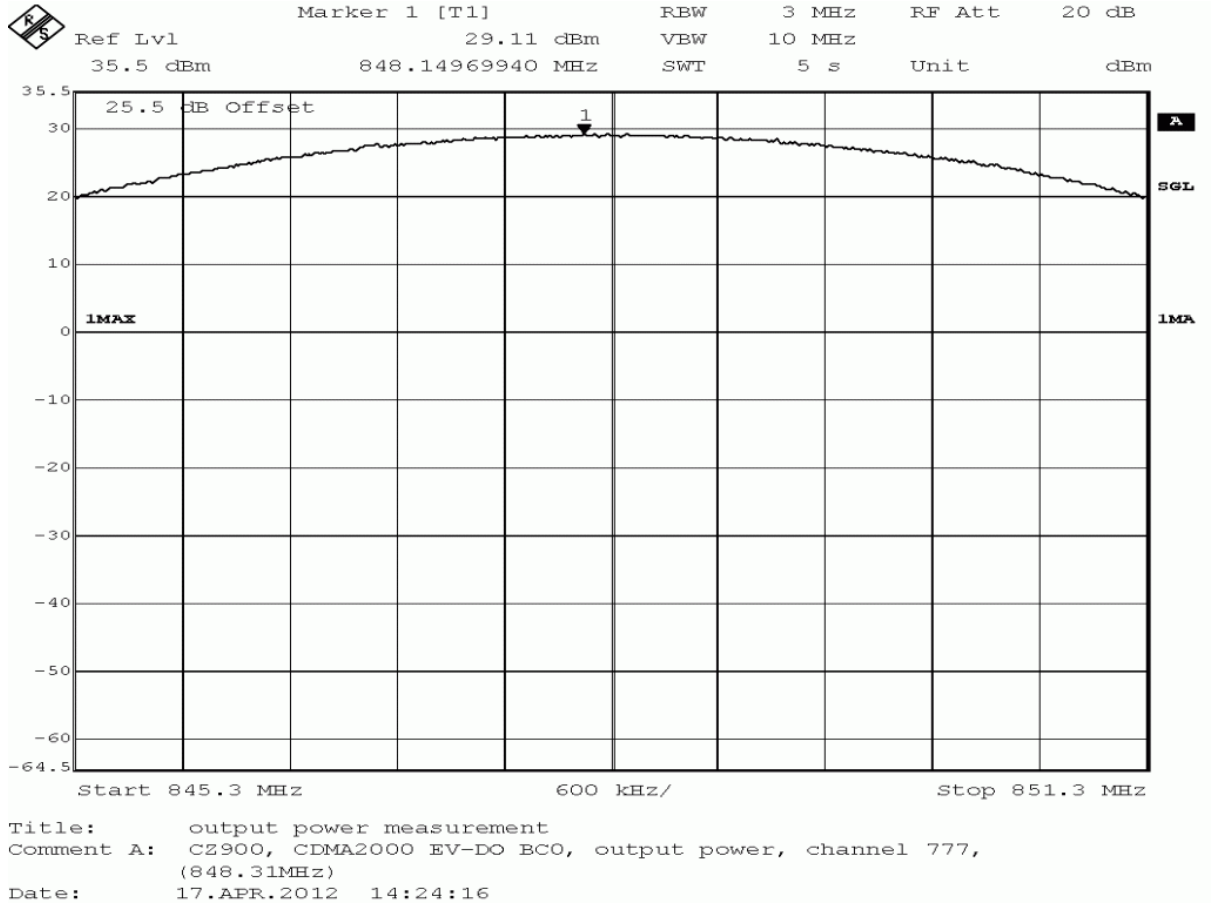



detector	trace	resolution bandwidth /kHz	conducted power /dBm	limit /dBm	margin /dB	verdict
peak	maxhold	3000	29.1	38.45	9.3	passed
average	maxhold	3000	22.1	38.45	16.4	passed
rms	maxhold	3000	22.7	38.45	15.7	passed

no external antenna gain is specified, the verdict is valid for the gain of an external antenna equal or less than 11.5 dBi (related to peak-value, worst-case)

Test: 22.1; Frequency Band = BC0, Mode = CDMA2000_EV-DO, Channel = 777, Frequency = 848.3MHz, Method = radiated

Result: Passed
Setup No.: B01_rad
Date of Test: 2012/05/24 12:41
Body: FCC47CFRChIPART22PUBLIC MOBILE SERVICES
Test Specification: FCC part 2 and 22

Detailed Results:

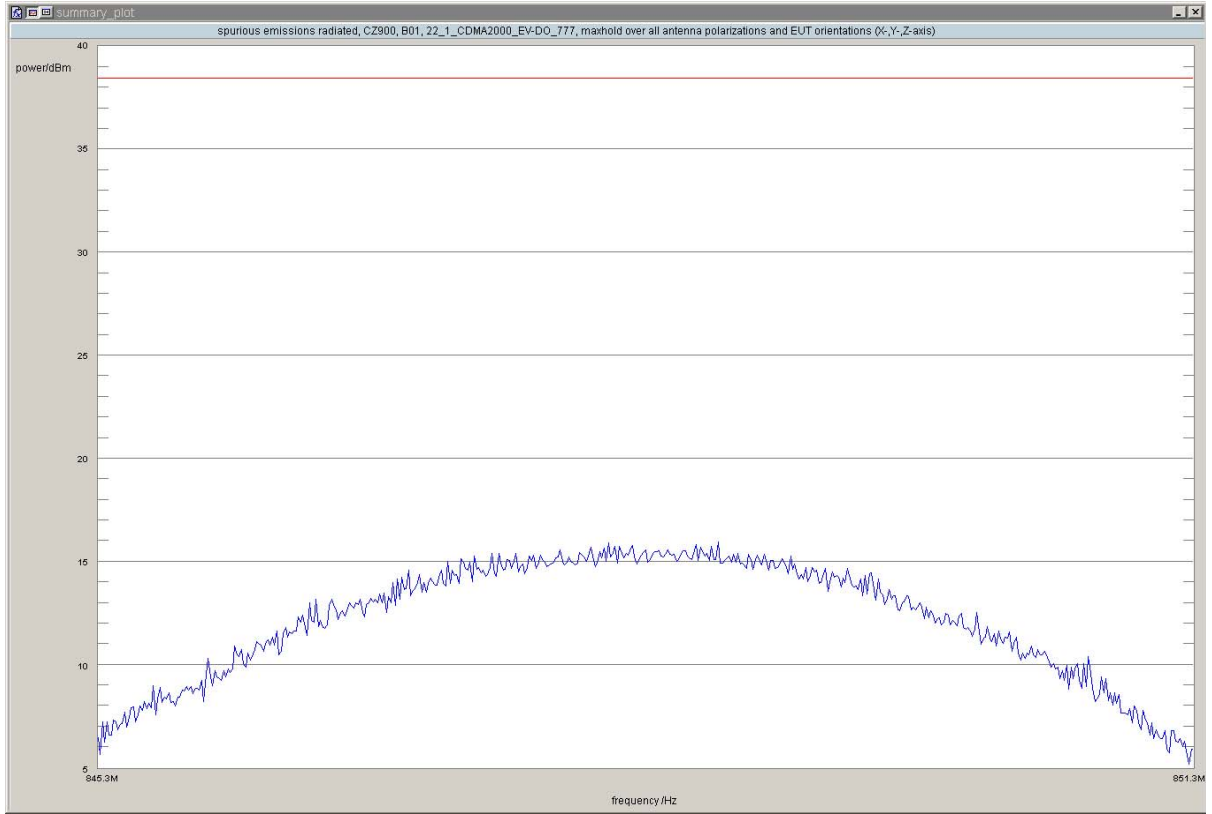

detector	trace	resolution bandwidth /kHz	frequency /MHz	peak value /dBm	limit /dBm	margin to limit /dB	azimuth /°	antenna polarization	EUT orientation	verdict
rms	maxhold	3000	848.7	15.95	38.45	22.50	90.0	horizontal	vertical	passed

no further values have been found with a margin of less than 20 dB



3.5.2 22.2 Frequency stability §2.1055

Test: 22.2; Frequency Band = BC0, Mode = CDMA2000, Channel = 384, Frequency = 836.5MHz

Result: Passed
 Setup No.: B01_cond
 Date of Test: 2012/04/18 18:28
 Body: FCC47CFRChIPART22PUBLIC MOBILE SERVICES
 Test Specification: FCC part 2 and 22

Detailed Results:

Temp. °C	Duration min	Voltage	Limit Hz	Freq. error Average (Hz)	Freq. error Max. (Hz)	Verdict
-30	0	normal	2095.5	-3	-7	passed
-30	5			-3	-6	passed
-30	10			-3	-6	passed
-20	0	normal	2095.5	-4	-7	passed
-20	5			-3	-6	passed
-20	10			-3	-6	passed
-10	0	normal	2095.5	-2	-3	passed
-10	5			-2	-4	passed
-10	10			-3	-5	passed
0	0	normal	2095.5	-3	-6	passed
0	5			-3	-7	passed
0	10			-1	-6	passed
10	0	normal	2095.5	-4	-8	passed
10	5			1	5	passed
10	10			-1	-8	passed
20	0	low	2095.5	0	7	passed
20	5			2	4	passed
20	10			0	7	passed
20	0	normal = high ¹⁾	2095.5	-2	-8	passed
20	5			-1	-8	passed
20	10			2	5	passed
30	0	normal	2095.5	0	5	passed
30	5			1	4	passed
30	10			3	6	passed
40	0	normal	2095.5	-1	-4	passed
40	5			3	7	passed
40	10			3	6	passed
50	0	normal	2095.5	1	8	passed
50	5			3	7	passed
50	10			3	6	passed

1) The manufacturer declared that normal voltage is equivalent with high voltage.



Test: 22.2; Frequency Band = BC0, Mode = CDMA2000_EV-DO, Channel = 384, Frequency = 836.5MHz

Result: Passed
 Setup No.: B01_cond
 Date of Test: 2012/04/18 18:30
 Body: FCC47CFRChIPART22PUBLIC MOBILE SERVICES
 Test Specification: FCC part 2 and 22

Detailed Results:

Temp. °C	Duration min	Voltage	Limit Hz	Freq. error Average (Hz)	Freq. error Max. (Hz)	Verdict
-30	0	normal	2095.5	-3	-6	passed
-30	5			-4	-6	passed
-30	10			-4	-6	passed
-20	0	normal	2095.5	-4	-6	passed
-20	5			-4	-6	passed
-20	10			-3	-6	passed
-10	0	normal	2095.5	-4	-8	passed
-10	5			-4	-7	passed
-10	10			-3	-6	passed
0	0	normal	2095.5	-4	-6	passed
0	5			-2	5	passed
0	10			-2	-5	passed
10	0	normal	2095.5	-1	-4	passed
10	5			-1	-3	passed
10	10			-1	-4	passed
20	0	low	2095.5	-2	-3	passed
20	5			1	-3	passed
20	10			2	3	passed
20	0	normal = high ¹⁾	2095.5	-1	-4	passed
20	5			2	7	passed
20	10			5	10	passed
30	0	normal	2095.5	2	5	passed
30	5			2	4	passed
30	10			2	5	passed
40	0	normal	2095.5	2	5	passed
40	5			3	5	passed
40	10			3	4	passed
50	0	normal	2095.5	3	5	passed
50	5			4	5	passed
50	10			3	6	passed

1) The manufacturer declared that normal voltage is equivalent with high voltage.



Reference: MDE_CINTE_1203_FCC22b_V1

acc. Title 47 CFR chapter I part 22 subpart H

3.5.3 22.3 Spurious emissions at antenna terminals §2.1051, §22.917

Test: 22.3; Frequency Band = BC0, Mode = CDMA2000, Channel = 1013, Frequency = 824.7MHz

<i>Result:</i>	Passed
<i>Setup No.:</i>	B01_cond
<i>Date of Test:</i>	2012/04/17 11:24
<i>Body:</i>	FCC47CFRChIPART22PUBLIC MOBILE SERVICES
<i>Test Specification:</i>	FCC part 2 and 22

Detailed Results:

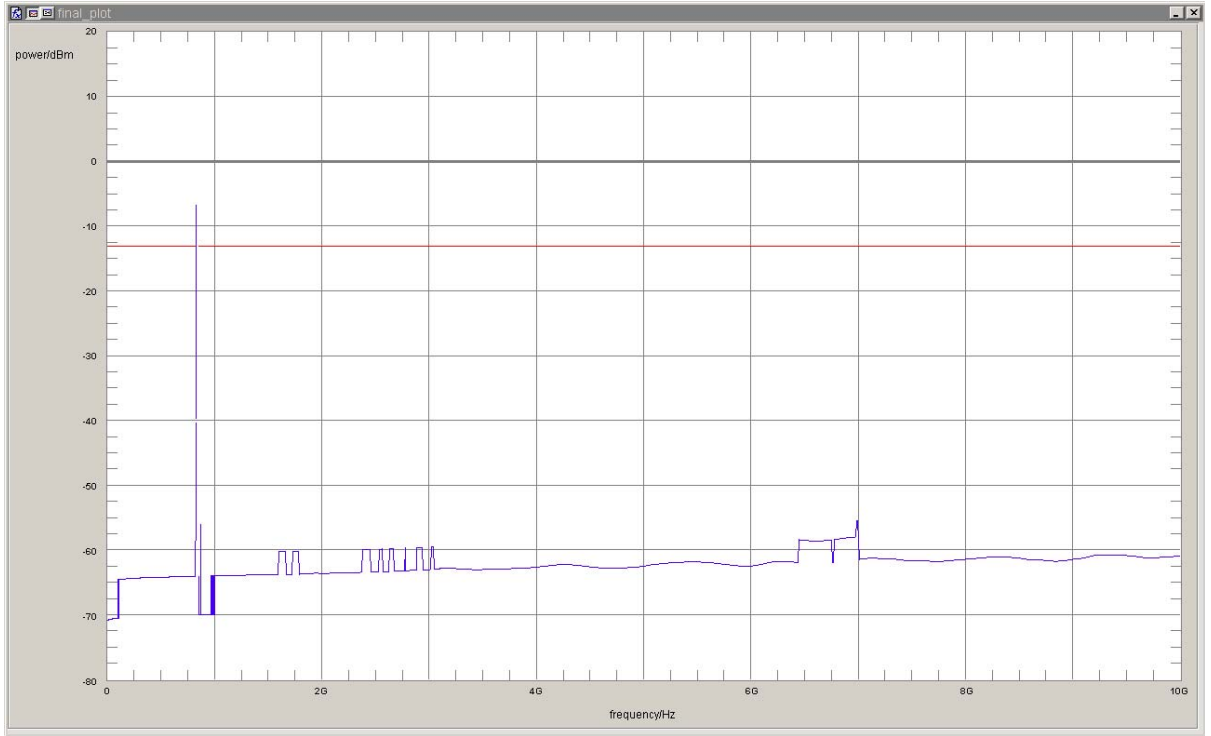

detector	trace	resolution bandwidth /kHz	frequency /MHz	peak value /dBm	margin to limit /dB	limit /dBm	verdict
rms	maxhold	50	824.00	-6.7	-6.3	-13.0	passed

no further values have been found with a margin of less than 20 dB
 peak over limit is the carrier

Test: 22.3; Frequency Band = BC0, Mode = CDMA2000, Channel = 384, Frequency = 836.5MHz

Result: Passed
Setup No.: B01_cond
Date of Test: 2012/04/17 11:30
Body: FCC47CFRChIPART22PUBLIC MOBILE SERVICES
Test Specification: FCC part 2 and 22

Detailed Results:

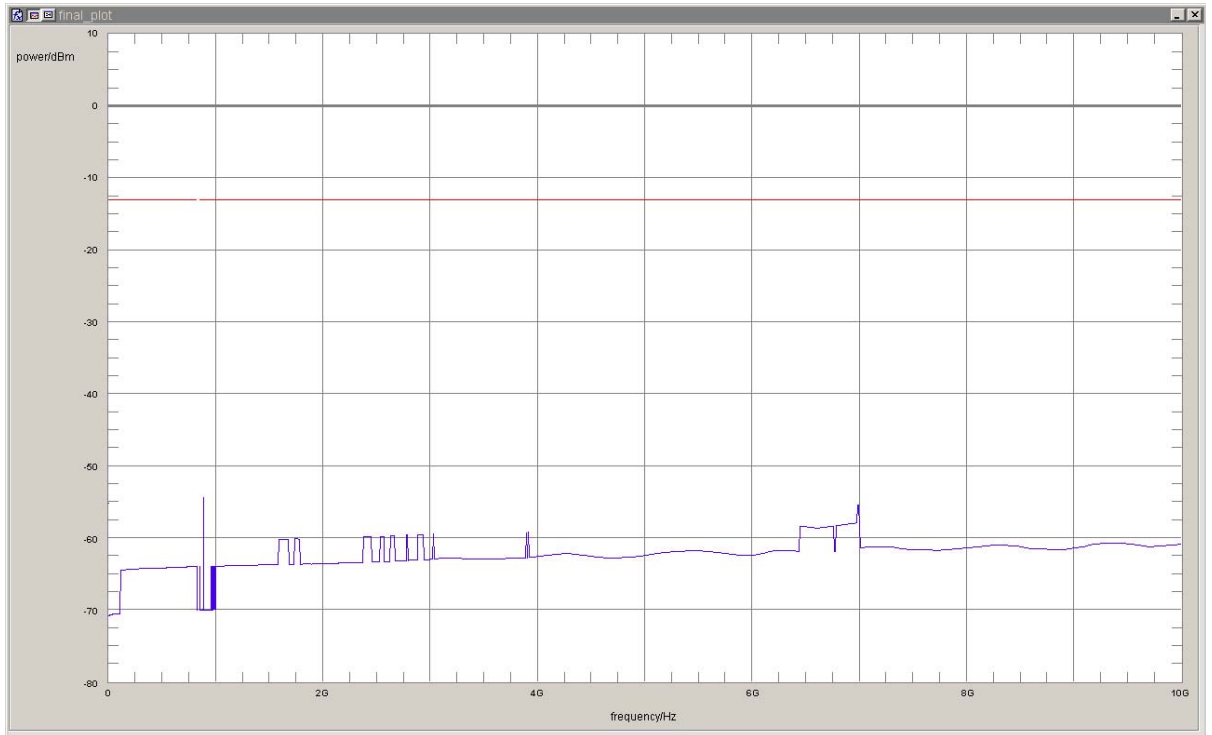

detector	trace	resolution bandwidth /kHz	frequency /MHz	peak value /dBm	margin to limit /dB	limit /dBm	verdict
rms	maxhold	100	881.040	-54.41	41.41	-13	passed

no further values have been found with a margin of less than 20 dB

Test: 22.3; Frequency Band = BC0, Mode = CDMA2000, Channel = 777, Frequency = 848.3MHz

Result: Passed
 Setup No.: B01_cond
 Date of Test: 2012/04/17 11:38
 Body: FCC47CFRChIPART22PUBLIC MOBILE SERVICES
 Test Specification: FCC part 2 and 22

Detailed Results:

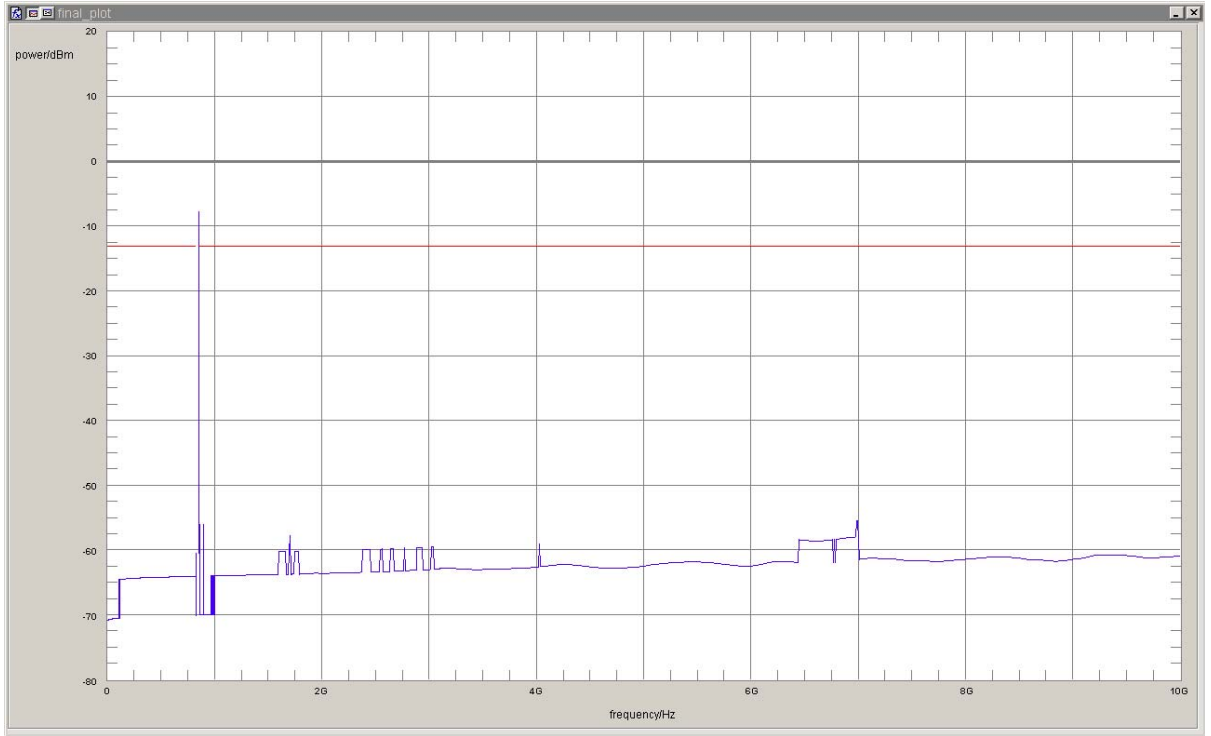

detector	trace	resolution bandwidth /kHz	frequency /MHz	peak value /dBm	margin to limit /dB	limit /dBm	verdict
rms	maxhold	50	849.00	-7.7	-5.3	-13.0	passed
rms	maxhold	50	849.23	-27.7	14.7	-13.0	passed

no further values have been found with a margin of less than 20 dB
 peak over limit is the carrier

Test: 22.3; Frequency Band = BC0, Mode = CDMA2000_EV-DO, Channel = 1013, Frequency = 824.7MHz

Result: Passed
Setup No.: B01_cond
Date of Test: 2012/04/17 14:42
Body: FCC47CFRChIPART22PUBLIC MOBILE SERVICES
Test Specification: FCC part 2 and 22

Detailed Results:

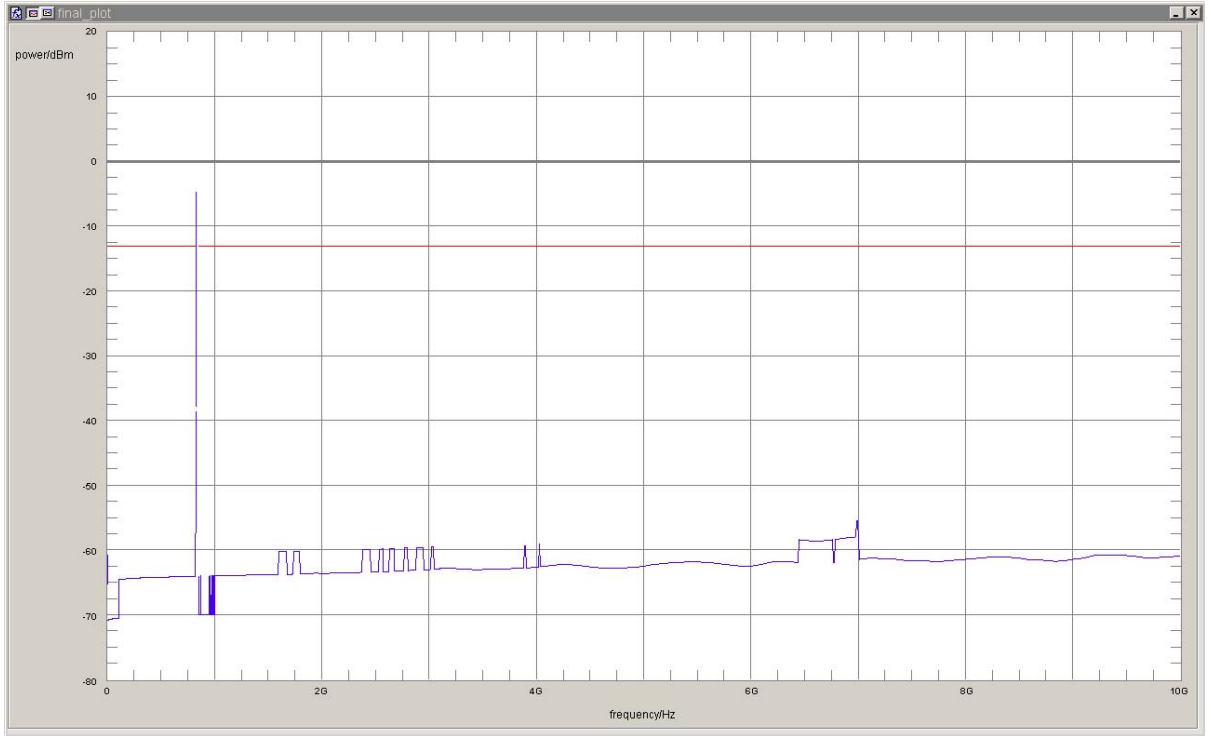

detector	trace	resolution bandwidth /kHz	frequency /MHz	peak value /dBm	margin to limit /dB	limit /dBm	verdict
rms	maxhold	50	823.08	-30.7	17.7	-13.0	passed
rms	maxhold	50	823.28	-29.3	16.3	-13.0	passed
rms	maxhold	50	823.51	-26.9	13.9	-13.0	passed
rms	maxhold	50	824.00	-4.5	-8.5	-13.0	passed

no further values have been found with a margin of less than 20 dB
 peak over limit is the carrier

Test: 22.3; Frequency Band = BC0, Mode = CDMA2000_EV-DO, Channel = 384, Frequency = 836.5MHz

Result: Passed
Setup No.: B01_cond
Date of Test: 2012/04/17 14:33
Body: FCC47CFRChIPART22PUBLIC MOBILE SERVICES
Test Specification: FCC part 2 and 22

Detailed Results:

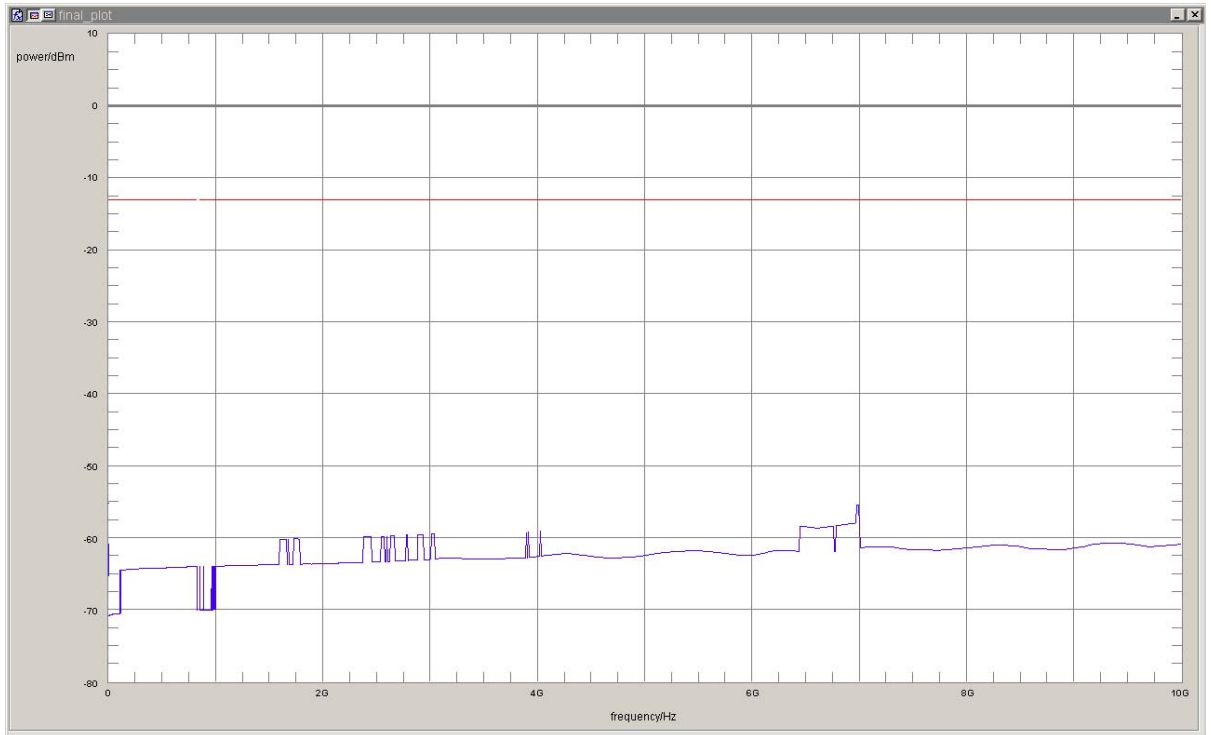

detector	trace	resolution bandwidth /kHz	frequency /MHz	peak value /dBm	margin to limit /dB	limit /dBm	verdict
rms	maxhold	1	0.009	-55.22	42.22	-13	passed

no further values have been found with a margin of less than 20 dB

Test: 22.3; Frequency Band = BC0, Mode = CDMA2000_EV-DO, Channel = 777, Frequency = 848.3MHz

Result: Passed
 Setup No.: B01_cond
 Date of Test: 2012/04/17 14:42
 Body: FCC47CFRChIPART22PUBLIC MOBILE SERVICES
 Test Specification: FCC part 2 and 22

Detailed Results:

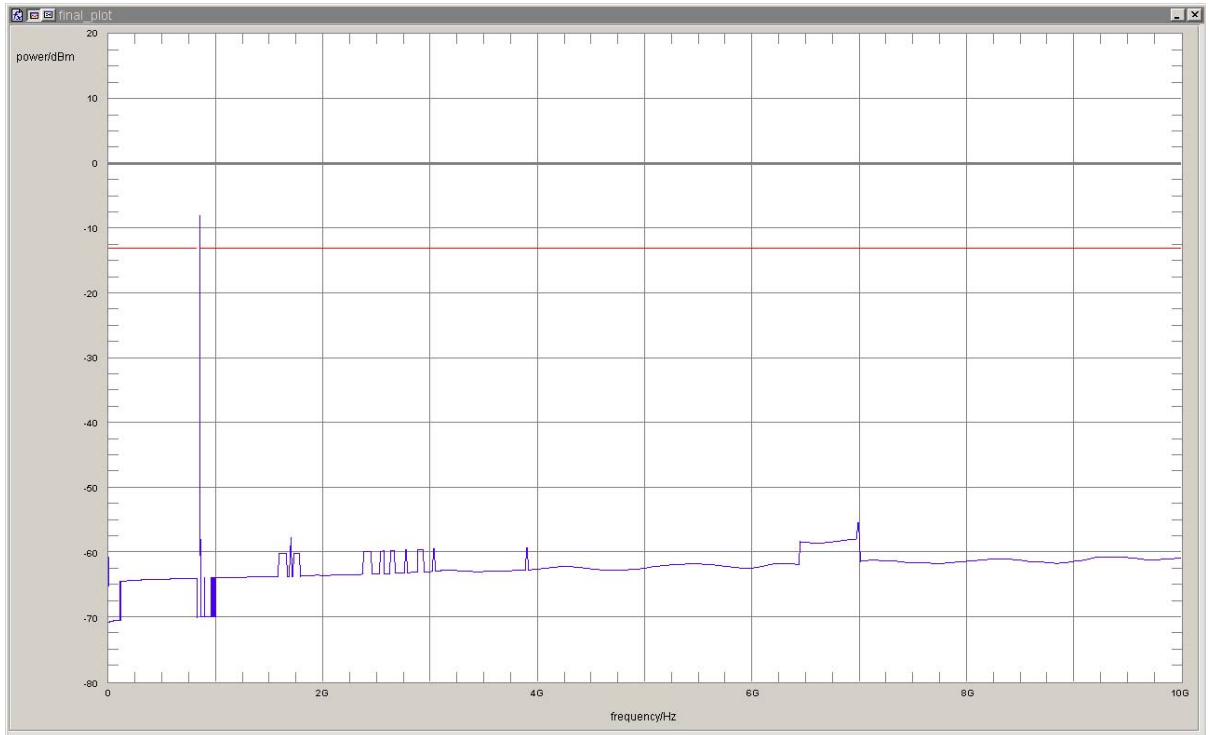

detector	trace	resolution bandwidth /kHz	frequency /MHz	peak value /dBm	margin to limit /dB	limit /dBm	verdict
rms	maxhold	50	849.00	-8.1	-4.9	-13.0	passed

no further values have been found with a margin of less than 20 dB
 peak over limit is the carrier

3.5.4 22.4 Field strength of spurious radiation §2.1053, §22.917

Test: 22.4; Frequency Band = BC0, Mode = CDMA2000, Channel = 1013, Frequency = 824.7MHz

Result: Passed
 Setup No.: B01_rad
 Date of Test: 2012/03/20 15:41
 Body: FCC47CFRChIPART22PUBLIC MOBILE SERVICES
 Test Specification: FCC part 2 and 22

Detailed Results:

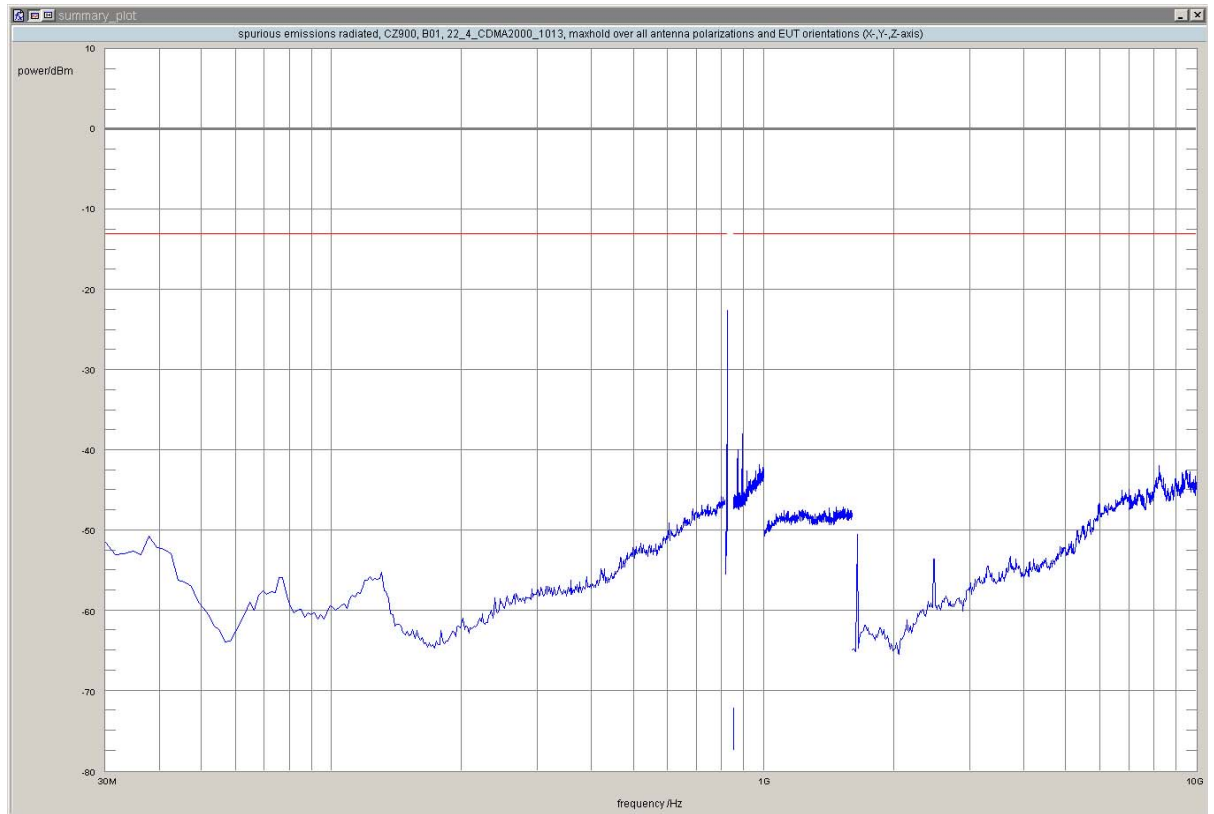

detector	trace	resolution bandwidth /kHz	frequency /MHz	peak value /dBm	limit /dBm	margin to limit /dB	azimuth /°	antenna polarization	EUT orientation	verdict
peak	maxhold	100	822.98	-28.84	-13.00	15.84	-180.0	vertical	horizontal	passed
peak	maxhold	3	823.7756	-32.38	-13.00	19.38	-180.0	vertical	horizontal	passed
peak	maxhold	3	823.7816	-32.35	-13.00	19.35	-90.0	horizontal	vertical	passed
peak	maxhold	3	823.7856	-32.83	-13.00	19.83	0.0	vertical	horizontal	passed
peak	maxhold	3	823.9319	-31.08	-13.00	18.08	0.0	vertical	horizontal	passed
peak	maxhold	3	823.9399	-31.47	-13.00	18.47	90.0	vertical	vertical	passed
peak	maxhold	3	823.9439	-28.22	-13.00	15.22	-180.0	vertical	horizontal	passed
peak	maxhold	3	823.9479	-28.71	-13.00	15.71	90.0	horizontal	vertical	passed
peak	maxhold	3	824.0000	-22.42	-13.00	9.42	-90.0	horizontal	vertical	passed

no further values have been found with a margin of less than 20 dB

Test: 22.4; Frequency Band = BC0, Mode = CDMA2000, Channel = 384, Frequency = 836.5MHz

Result: Passed
 Setup No.: B01_rad
 Date of Test: 2012/03/20 15:54
 Body: FCC47CFRChIPART22PUBLIC MOBILE SERVICES
 Test Specification: FCC part 2 and 22

Detailed Results:

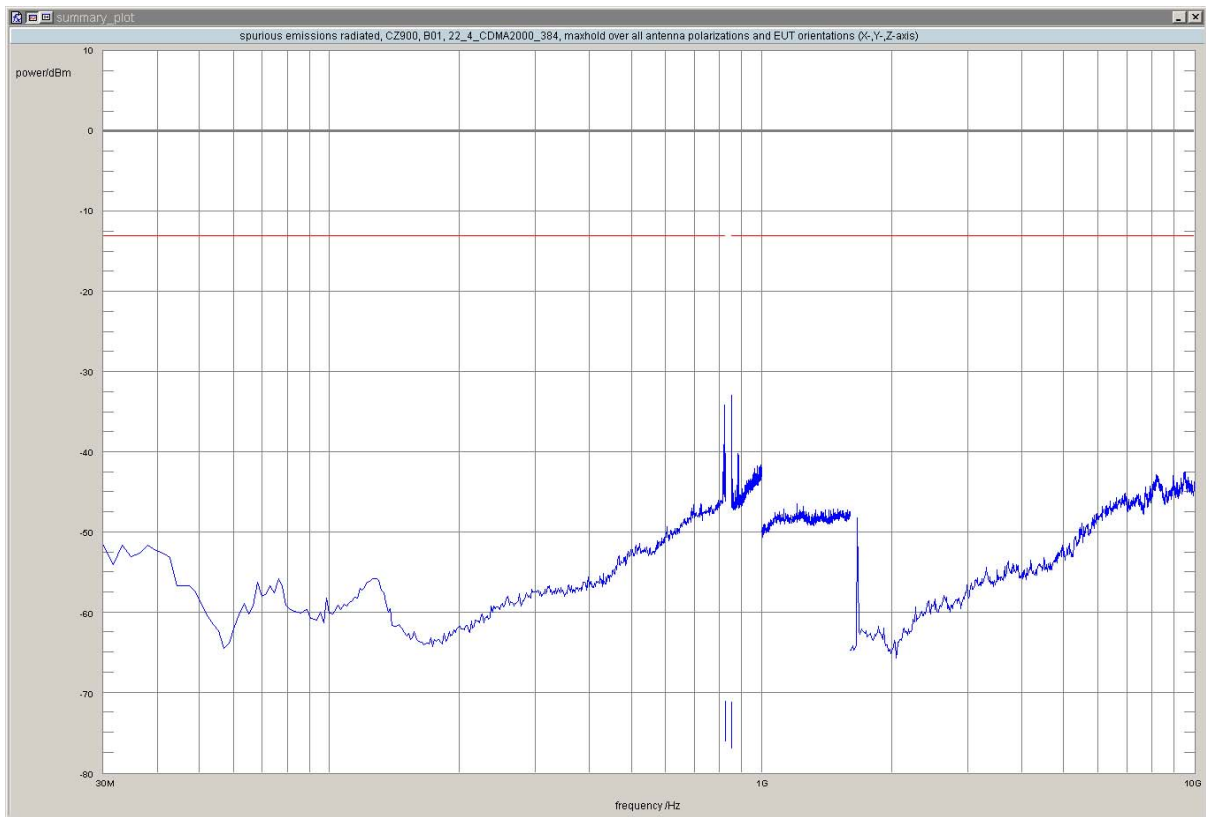

detector	trace	resolution bandwidth /kHz	frequency /MHz	peak value /dBm	limit /dBm	margin to limit /dB	azimuth /°	antenna polarization	EUT orientation	verdict
peak	maxhold	1000	851.8	-32.96	-13.00	19.96	-180.0	vertical	vertical	passed

no further values have been found with a margin of less than 20 dB

Test: 22.4; Frequency Band = BC0, Mode = CDMA2000, Channel = 777, Frequency = 848.3MHz

Result: Passed
 Setup No.: B01_rad
 Date of Test: 2012/04/25 15:55
 Body: FCC47CFRChIPART22PUBLIC MOBILE SERVICES
 Test Specification: FCC part 2 and 22

Detailed Results:

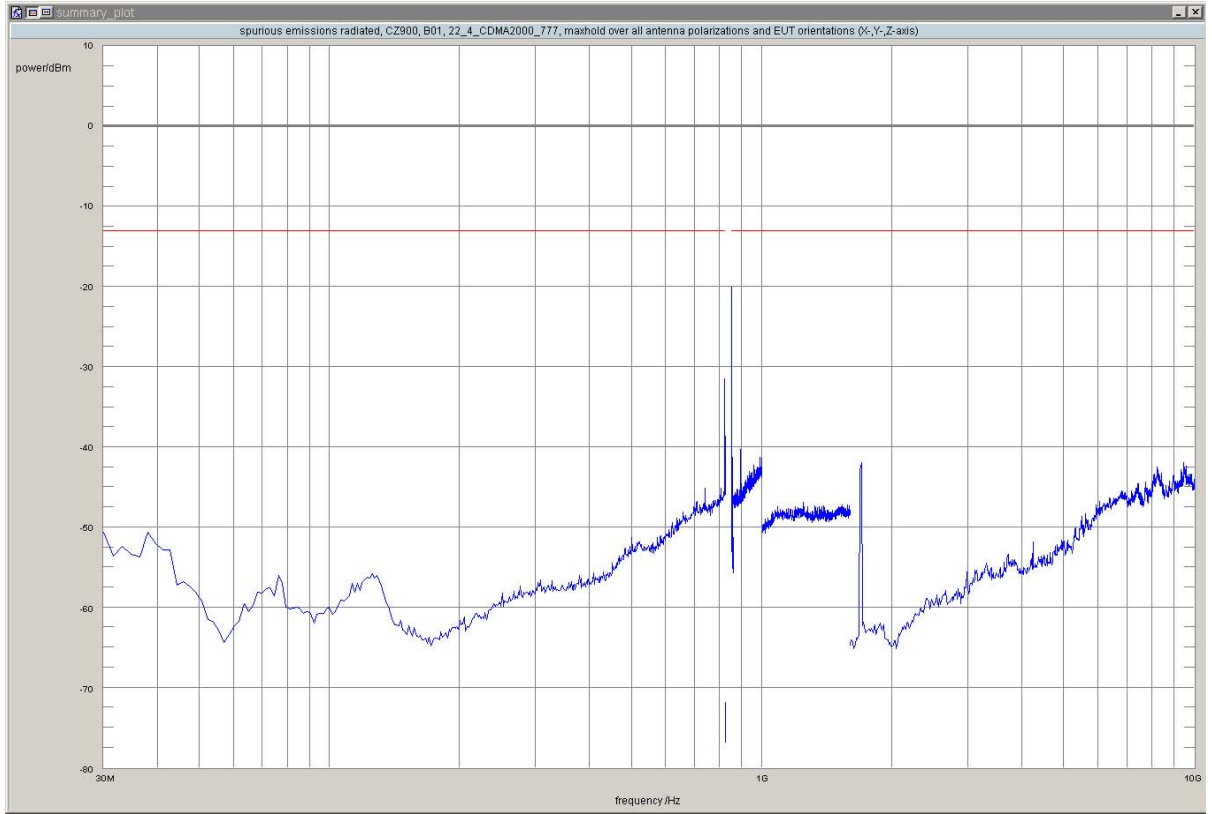

detector	trace	resolution bandwidth /kHz	frequency /MHz	peak value /dBm	limit /dBm	margin to limit /dB	azimuth /°	antenna polarization	EUT orientation	verdict
peak	maxhold	1000	819.8	-31.44	-13.00	18.44	-180.0	vertical	vertical	passed
peak	maxhold	3	849.0000	-20.09	-13.00	7.09	0.0	vertical	horizontal	passed
peak	maxhold	3	849.0581	-32.39	-13.00	19.39	-180.0	vertical	horizontal	passed
peak	maxhold	100	850.13	-30.01	-13.00	17.01	90.0	horizontal	vertical	passed
peak	maxhold	100	850.23	-31.79	-13.00	18.79	-90.0	horizontal	vertical	passed

no further values have been found with a margin of less than 20 dB

Test: 22.4; Frequency Band = BC0, Mode = CDMA2000_EV-DO, Channel = 1013, Frequency = 824.7MHz

Result: Passed

Setup No.: B01_rad

Date of Test: 2012/03/13 15:57

Body: FCC47CFRChIPART22PUBLIC MOBILE SERVICES

Test Specification: FCC part 2 and 22

Detailed Results:

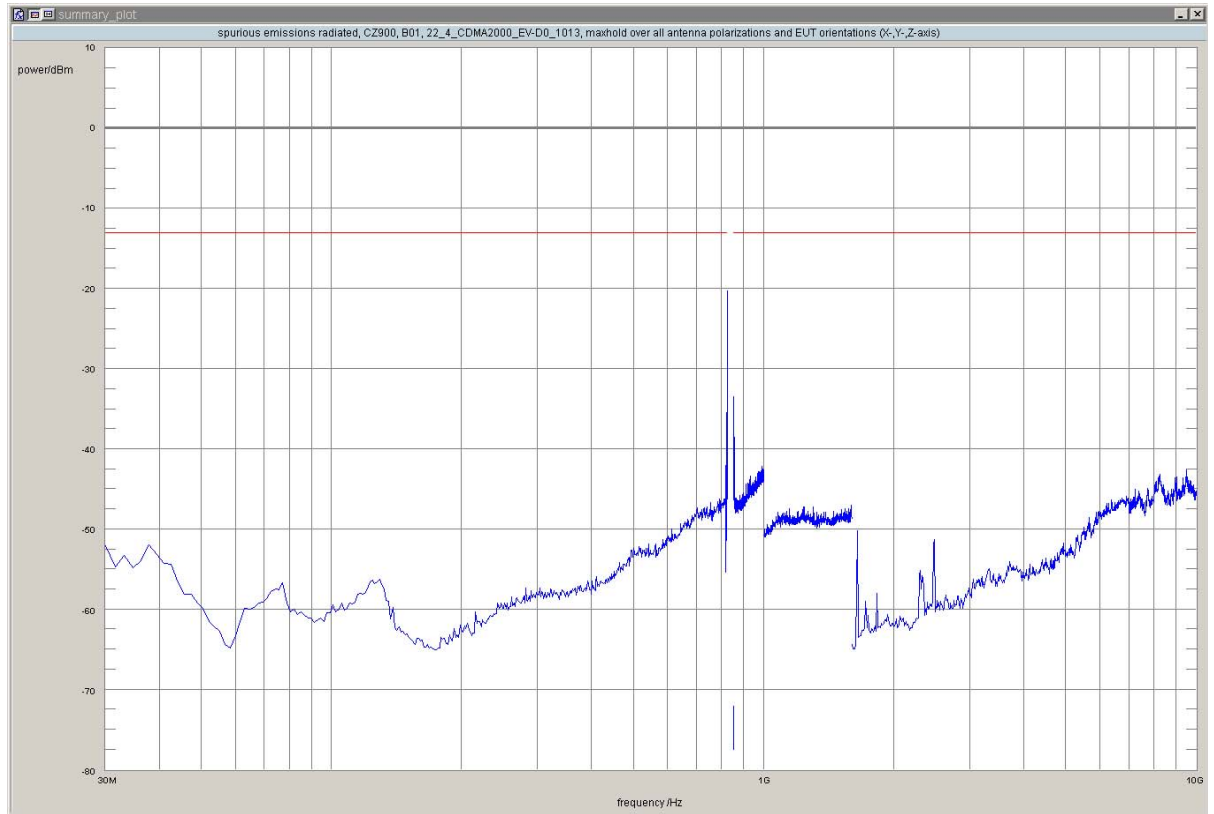

detector	trace	resolution bandwidth /kHz	frequency /MHz	peak value /dBm	limit /dBm	margin to limit /dB	azimuth /°	antenna polarization	EUT orientation	verdict
peak	maxhold	100	822.08	-26.54	-13.00	13.54	90.0	vertical	vertical	passed
peak	maxhold	100	822.30	-30.70	-13.00	17.70	-180.0	horizontal	horizontal	passed
peak	maxhold	100	822.93	-22.33	-13.00	9.33	-180.0	vertical	horizontal	passed
peak	maxhold	3	823.8657	-32.22	-13.00	19.22	-180.0	vertical	horizontal	passed
peak	maxhold	3	823.8758	-32.05	-13.00	19.05	-90.0	vertical	vertical	passed
peak	maxhold	3	823.8958	-32.40	-13.00	19.40	-180.0	vertical	horizontal	passed
peak	maxhold	3	823.9058	-32.40	-13.00	19.40	-180.0	vertical	horizontal	passed
peak	maxhold	3	823.9359	-31.15	-13.00	18.15	-180.0	vertical	horizontal	passed
peak	maxhold	3	824.0000	-20.15	-13.00	7.15	-180.0	vertical	horizontal	passed

no further values have been found with a margin of less than 20 dB

Test: 22.4; Frequency Band = BC0, Mode = CDMA2000_EV-DO, Channel = 384, Frequency = 836.5MHz

Result: Passed

Setup No.: B01_rad

Date of Test: 2012/03/13 16:00

Body: FCC47CFRChIPART22PUBLIC MOBILE SERVICES

Test Specification: FCC part 2 and 22

Detailed Results:

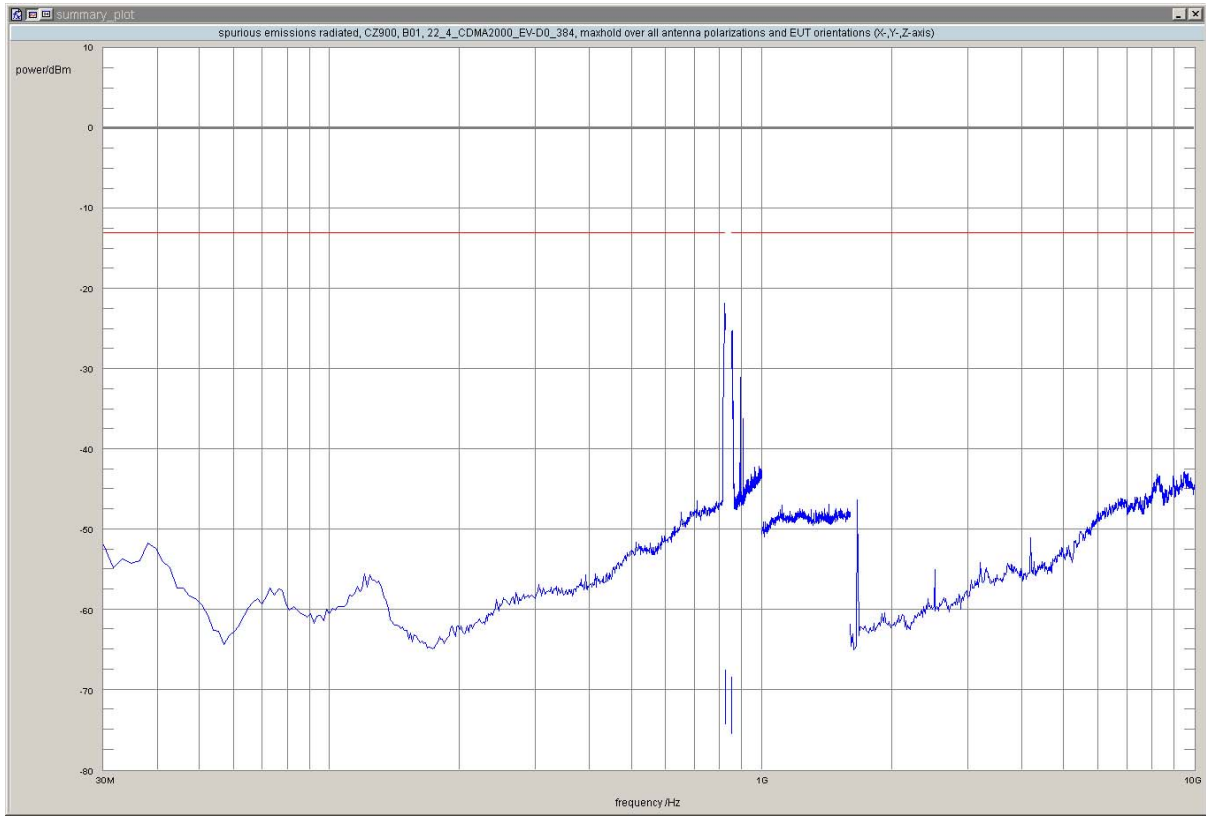

detector	trace	resolution bandwidth /kHz	frequency /MHz	peak value /dBm	limit /dBm	margin to limit /dB	azimuth /°	antenna polarization	EUT orientation	verdict
peak	maxhold	1000	819.8	-21.80	-13.00	8.80	90.0	horizontal	vertical	passed
peak	maxhold	1000	821.4	-24.26	-13.00	11.26	-180.0	vertical	horizontal	passed
peak	maxhold	1000	823.0	-26.64	-13.00	13.64	0.0	vertical	horizontal	passed
peak	maxhold	1000	853.0	-25.20	-13.00	12.20	-180.0	vertical	horizontal	passed
peak	maxhold	1000	854.2	-29.42	-13.00	16.42	-90.0	vertical	vertical	passed
peak	maxhold	1000	891.8	-31.03	-13.00	18.03	-180.0	vertical	vertical	passed

no further values have been found with a margin of less than 20 dB

Test: 22.4; Frequency Band = BC0, Mode = CDMA2000_EV-DO, Channel = 777, Frequency = 848.3MHz

Result: Passed

Setup No.: B01_rad

Date of Test: 2012/03/13 16:01

Body: FCC47CFRChIPART22PUBLIC MOBILE SERVICES

Test Specification: FCC part 2 and 22

Detailed Results:

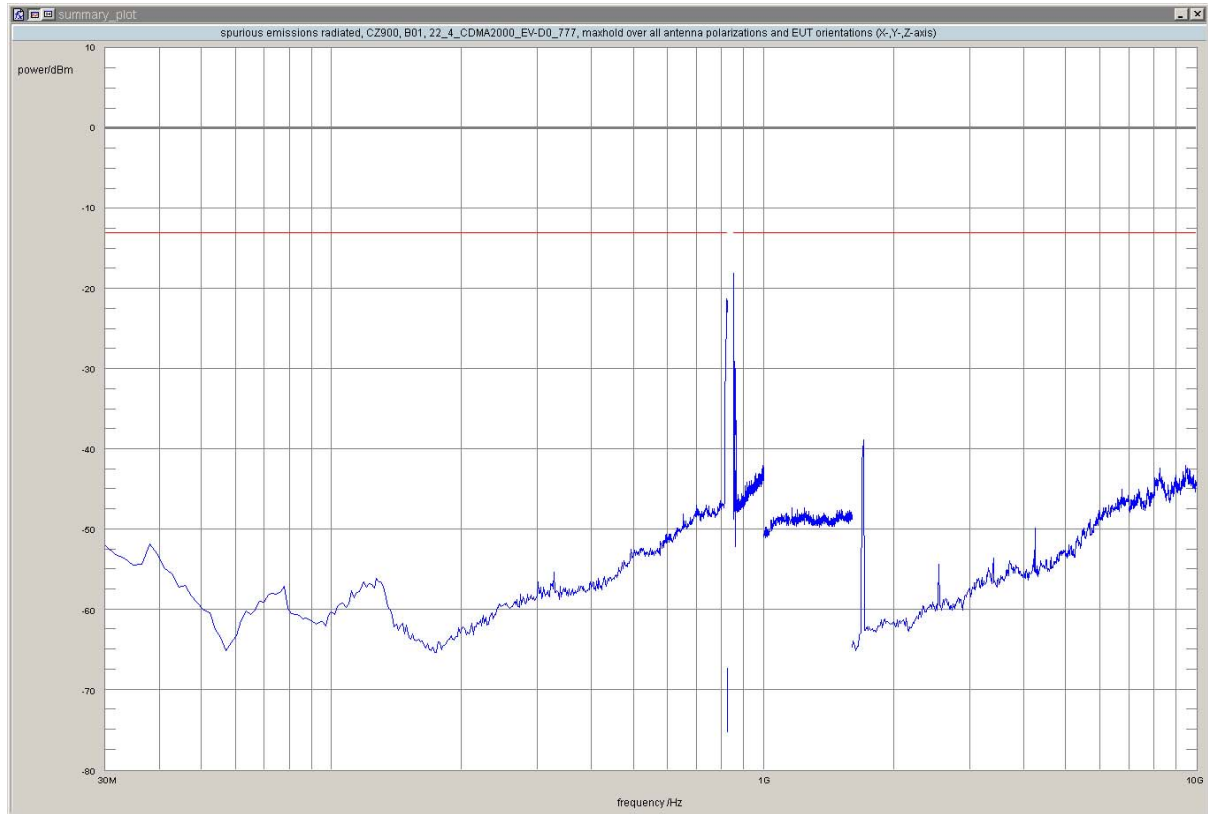

detector	trace	resolution bandwidth /kHz	frequency /MHz	peak value /dBm	limit /dBm	margin to limit /dB	azimuth /°	antenna polarization	EUT orientation	verdict
peak	maxhold	1000	816.6	-32.65	-13.00	19.65	90.0	vertical	vertical	passed
peak	maxhold	1000	818.2	-25.67	-13.00	12.67	-90.0	vertical	vertical	passed
peak	maxhold	1000	819.8	-21.24	-13.00	8.24	-180.0	vertical	horizontal	passed
peak	maxhold	1000	821.4	-23.01	-13.00	10.01	-90.0	horizontal	vertical	passed
peak	maxhold	1000	823.0	-27.40	-13.00	14.40	0.0	horizontal	vertical	passed
peak	maxhold	3	849.0020	-18.09	-13.00	5.09	-180.0	vertical	horizontal	passed
peak	maxhold	3	849.0120	-21.15	-13.00	8.15	0.0	vertical	horizontal	passed
peak	maxhold	3	849.0541	-32.97	-13.00	19.97	-180.0	vertical	horizontal	passed
peak	maxhold	3	849.1383	-32.94	-13.00	19.94	-180.0	vertical	horizontal	passed
peak	maxhold	100	850.22	-20.89	-13.00	7.89	90.0	horizontal	vertical	passed
peak	maxhold	100	853.93	-32.55	-13.00	19.55	0.0	vertical	horizontal	passed
peak	maxhold	1000	859.0	-29.97	-13.00	16.97	-180.0	vertical	horizontal	passed

no further values have been found with a margin of less than 20 dB



Reference: MDE_CINTE_1203_FCC22b_V1

acc. Title 47 CFR chapter I part 22 subpart H

3.5.5 22.5 Emission and Occupied Bandwidth §2.1049, §22.917

Test: 22.5; Frequency Band = BC0, Mode = CDMA2000_EV-DO; Channel = 777, Frequency = 848.3MHz

<i>Result:</i>	Passed
<i>Setup No.:</i>	B01_cond
<i>Date of Test:</i>	2012/04/17 14:29
<i>Body:</i>	FCC47CFRChIPART22PUBLIC MOBILE SERVICES
<i>Test Specification:</i>	FCC part 2 and 22

Detailed Results:

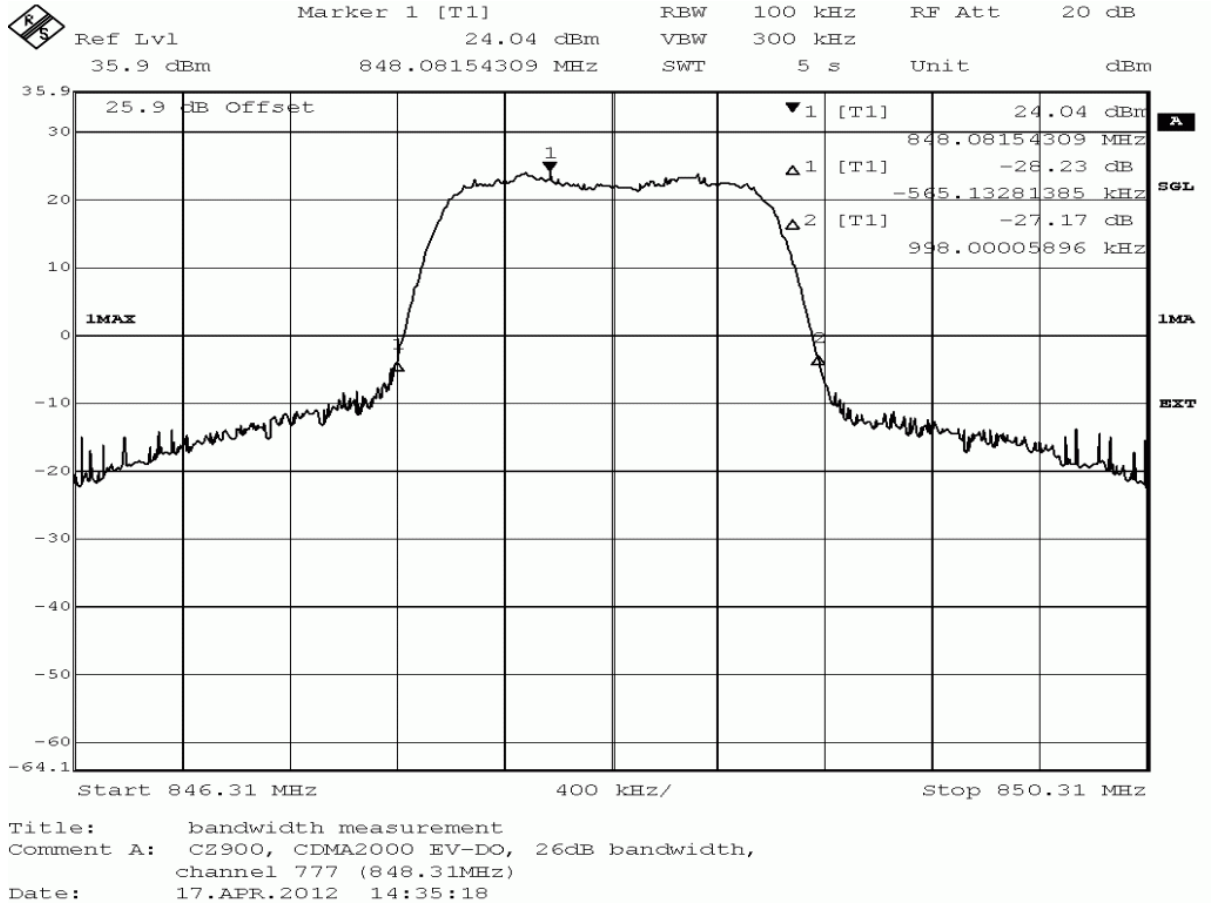

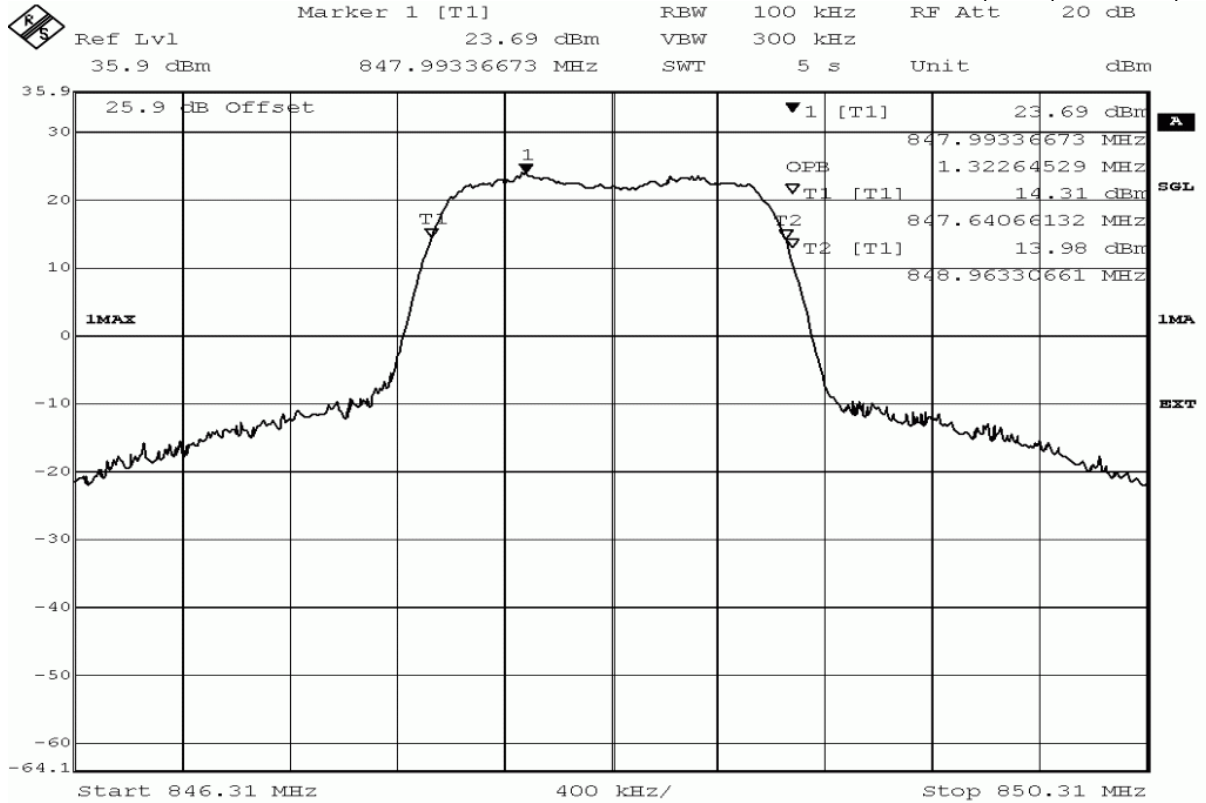

Title: bandwidth measurement
 Comment A: CZ900, CDMA2000 EV-DO, occupied bandwidth (99%),
 channel 777 (848.31MHz)
 Date: 17.APR.2012 14:35:36



detector	trace	resolution bandwidth /kHz	type of measurement	measured value /kHz	verdict
peak	maxhold	100	-26dB bandwidth	1563.1	passed
peak	maxhold	100	99% bandwidth	1322.6	passed

Test: 22.5; Frequency Band = BC0, Mode = CDMA2000, Channel = 1013, Frequency = 824.7MHz

Result: Passed
Setup No.: B01_cond
Date of Test: 2012/04/17 10:53
Body: FCC47CFRChIPART22PUBLIC MOBILE SERVICES
Test Specification: FCC part 2 and 22

Detailed Results:

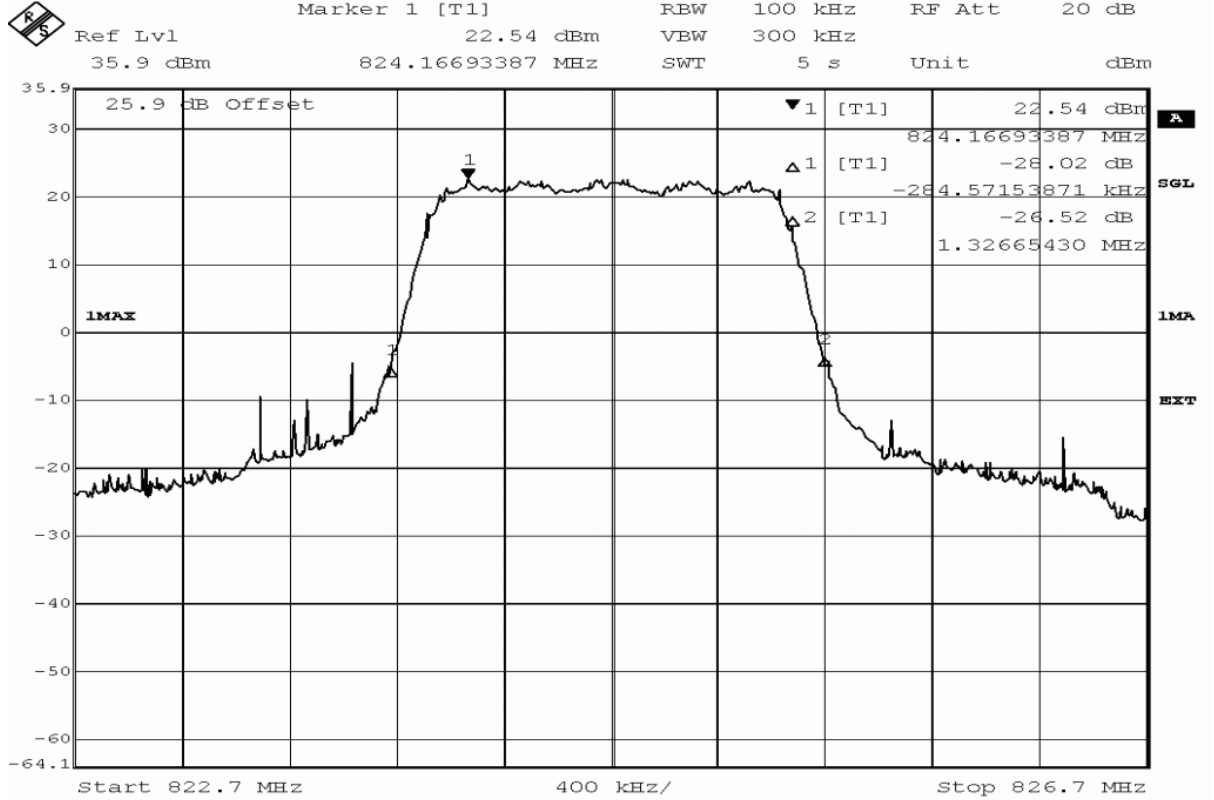

Title: bandwidth measurement
 Comment A: CZ900, CDMA2000 BCO, 26dB bandwidth,
 channel 1013 (824.7MHz)
 Date: 17.APR.2012 10:59:21

acc. Title 47 CFR chapter I part 22 subpart H

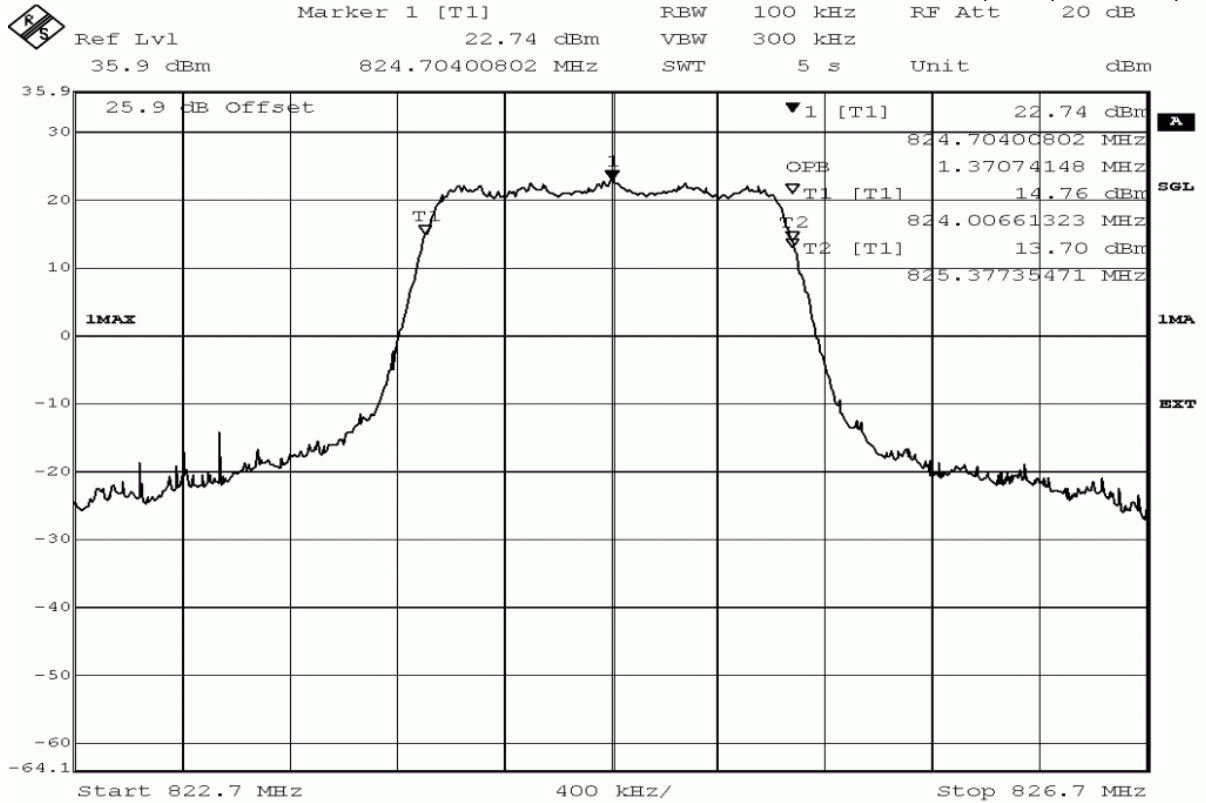

Title: bandwidth measurement
 Comment A: CZ900, CDMA2000 BCO, occupied bandwidth (99%),
 channel 1013 (824.7MHz)
 Date: 17.APR.2012 10:59:39



detector	trace	resolution bandwidth /kHz	type of measurement	measured value /kHz	verdict
peak	maxhold	100	-26dB bandwidth	1611.2	passed
peak	maxhold	100	99% bandwidth	1370.7	passed

Test: 22.5; Frequency Band = BC0, Mode = CDMA2000, Channel = 384 Frequency = 836.5MHz

Result: Passed
Setup No.: B01_cond
Date of Test: 2012/04/17 11:32
Body: FCC47CFRChIPART22PUBLIC MOBILE SERVICES
Test Specification: FCC part 2 and 22

Detailed Results:

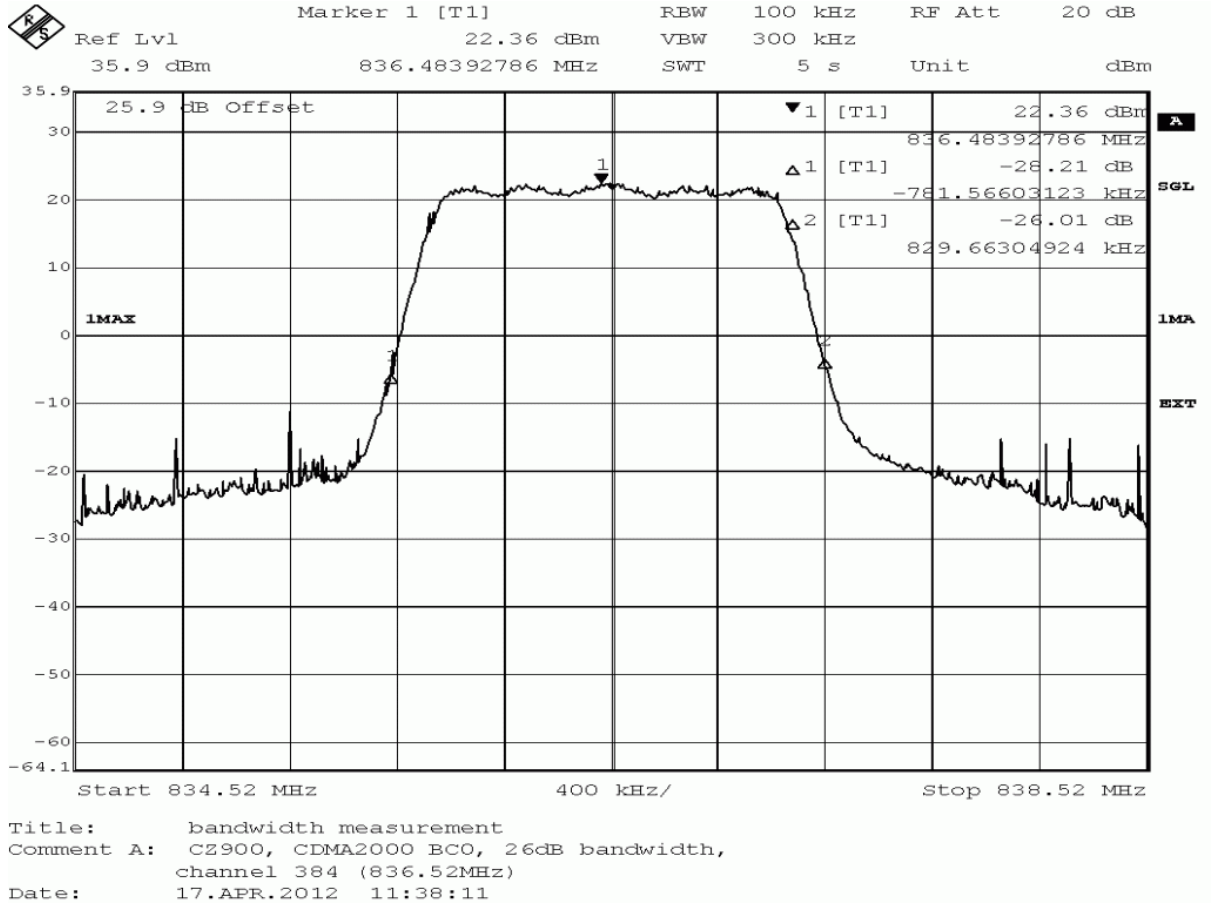

acc. Title 47 CFR chapter I part 22 subpart H

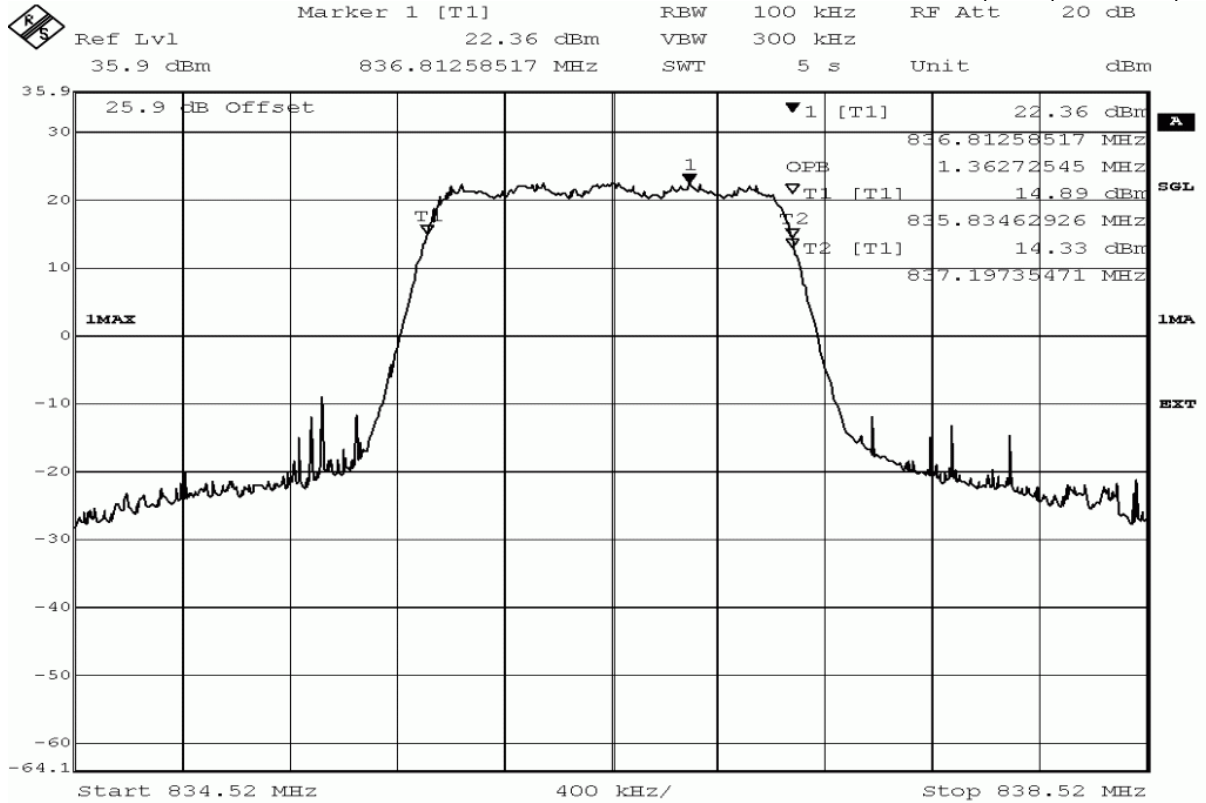

Title: bandwidth measurement
 Comment A: CZ900, CDMA2000 BCO, occupied bandwidth (99%),
 channel 384 (836.52MHz)
 Date: 17.APR.2012 11:38:29



detector	trace	resolution bandwidth /kHz	type of measurement	measured value /kHz	verdict
peak	maxhold	100	-26dB bandwidth	1611.2	passed
peak	maxhold	100	99% bandwidth	1362.7	passed

Test: 22.5; Frequency Band = BC0, Mode = CDMA2000, Channel = 777, Frequency = 848.3MHz

Result: Passed
Setup No.: B01_cond
Date of Test: 2012/04/17 11:40
Body: FCC47CFRChIPART22PUBLIC MOBILE SERVICES
Test Specification: FCC part 2 and 22

Detailed Results:

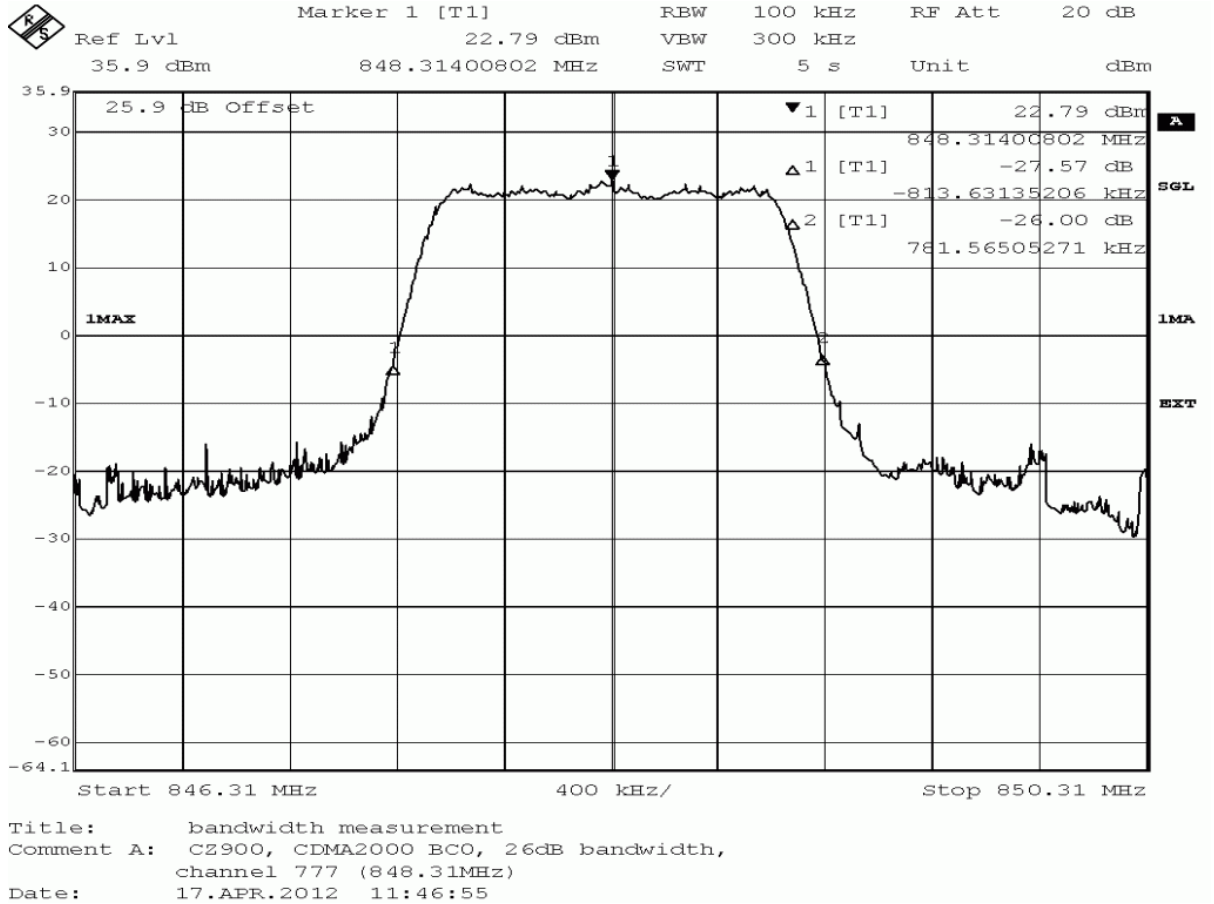

acc. Title 47 CFR chapter I part 22 subpart H

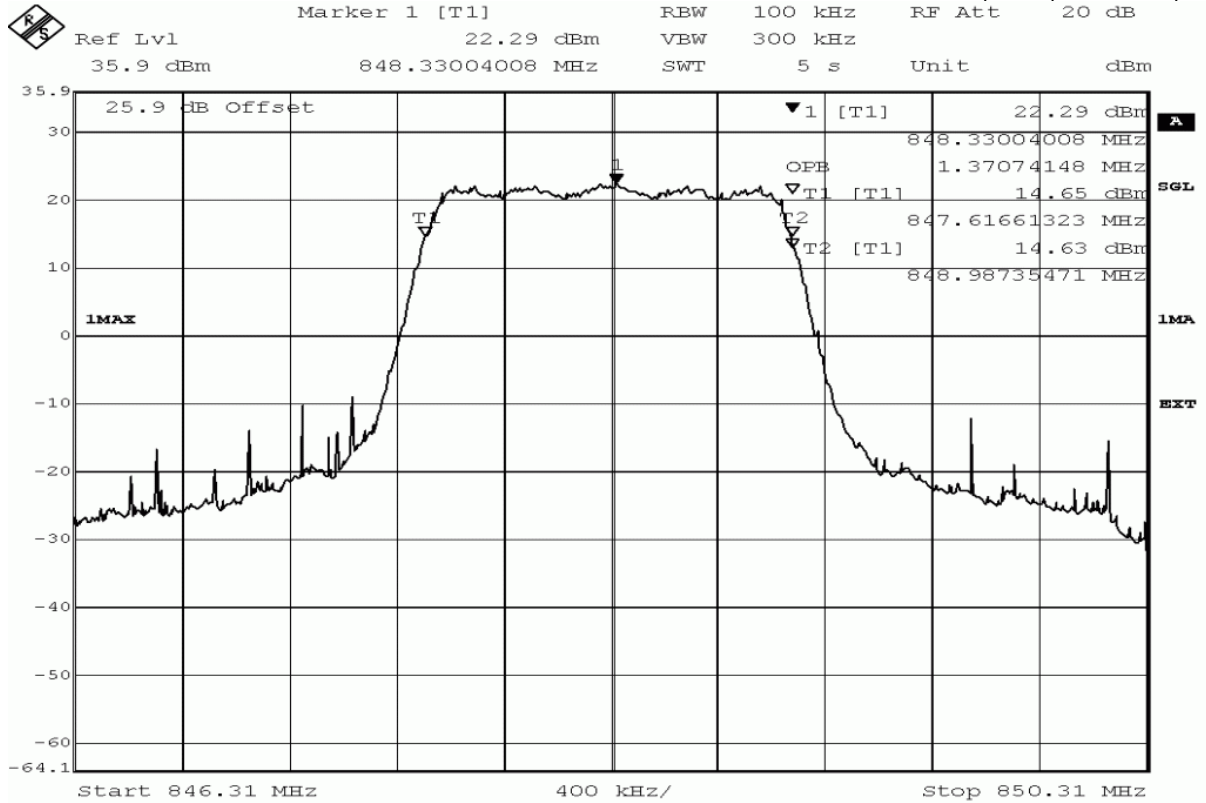

Title: bandwidth measurement
 Comment A: CZ900, CDMA2000 BCO, occupied bandwidth (99%),
 channel 777 (848.31MHz)
 Date: 17.APR.2012 11:47:13



detector	trace	resolution bandwidth /kHz	type of measurement	measured value /kHz	verdict
peak	maxhold	100	-26dB bandwidth	1595.2	passed
peak	maxhold	100	99% bandwidth	1370.7	passed

Test: 22.5; Frequency Band = BC0, Mode = CDMA2000_EV-DO, Channel = 1013, Frequency = 824.7MHz

Result: Passed

Setup No.: B01_cond

Date of Test: 2012/04/17 14:16

Body: FCC47CFRChIPART22PUBLIC MOBILE SERVICES

Test Specification: FCC part 2 and 22

Detailed Results:

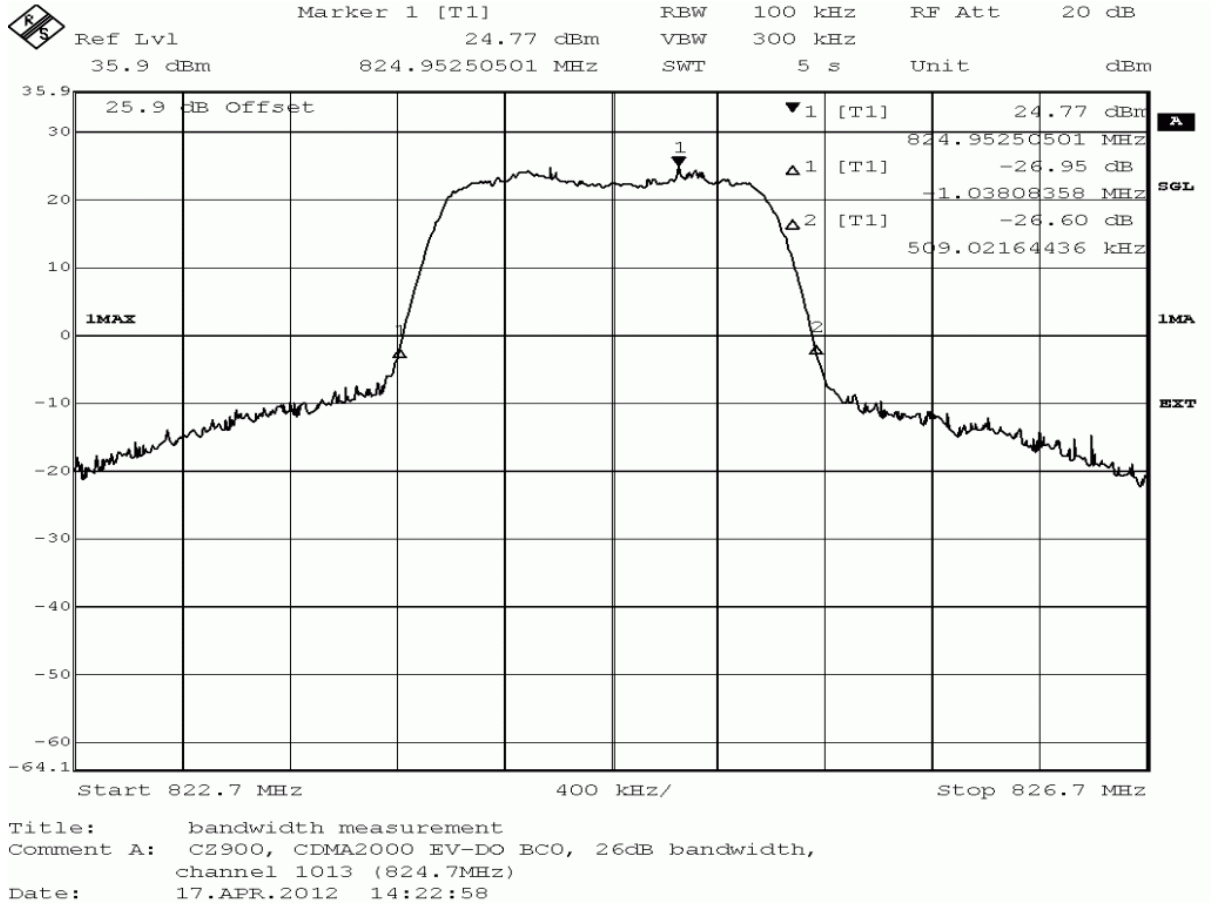

acc. Title 47 CFR chapter I part 22 subpart H

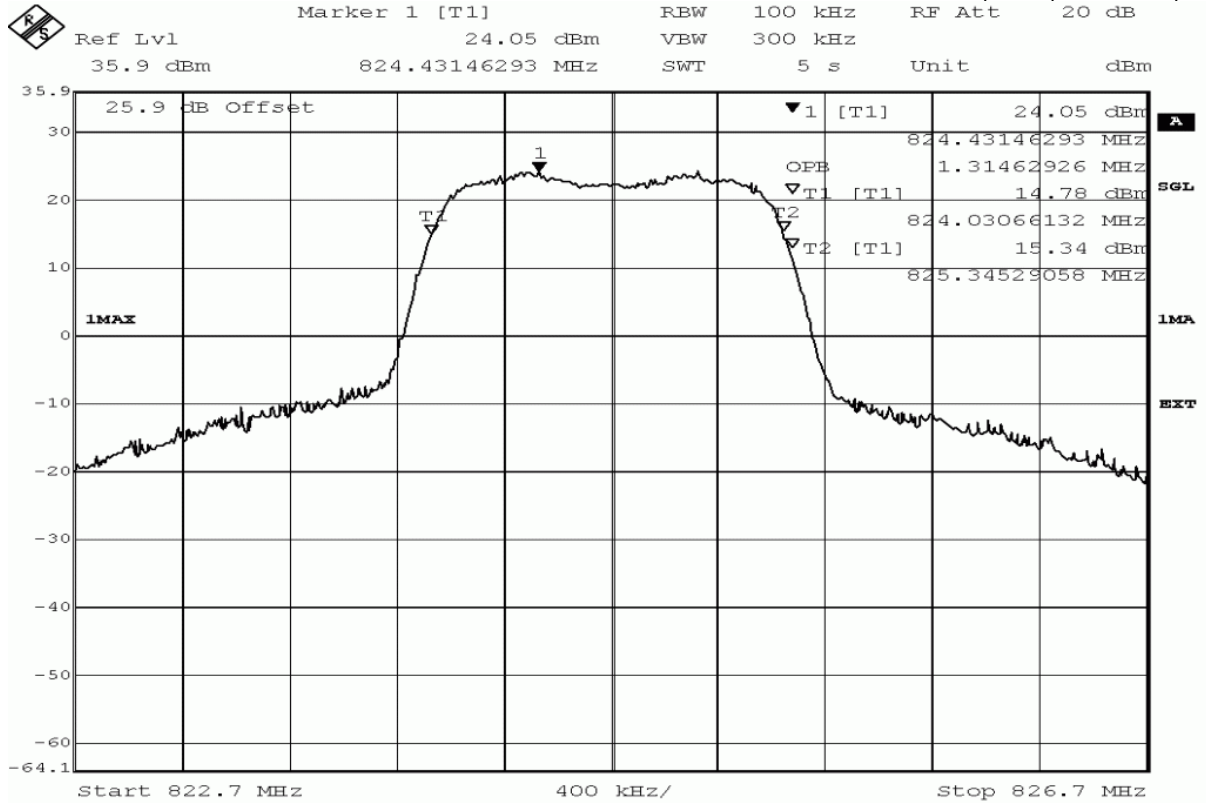

Title: bandwidth measurement
 Comment A: CZ900, CDMA2000 EV-DO BCO, occupied bandwidth (99%),
 channel 1013 (824.7MHz)
 Date: 17.APR.2012 14:23:16



detector	trace	resolution bandwidth /kHz	type of measurement	measured value /kHz	verdict
peak	maxhold	100	-26dB bandwidth	1547.1	passed
peak	maxhold	100	99% bandwidth	1314.6	passed

Test: 22.5; Frequency Band = BC0, Mode = CDMA2000_EV-DO, Channel = 384 Frequency = 836.5MHz

Result: Passed

Setup No.: B01_cond

Date of Test: 2012/04/17 14:34

Body: FCC47CFRChIPART22PUBLIC MOBILE SERVICES

Test Specification: FCC part 2 and 22

Detailed Results:

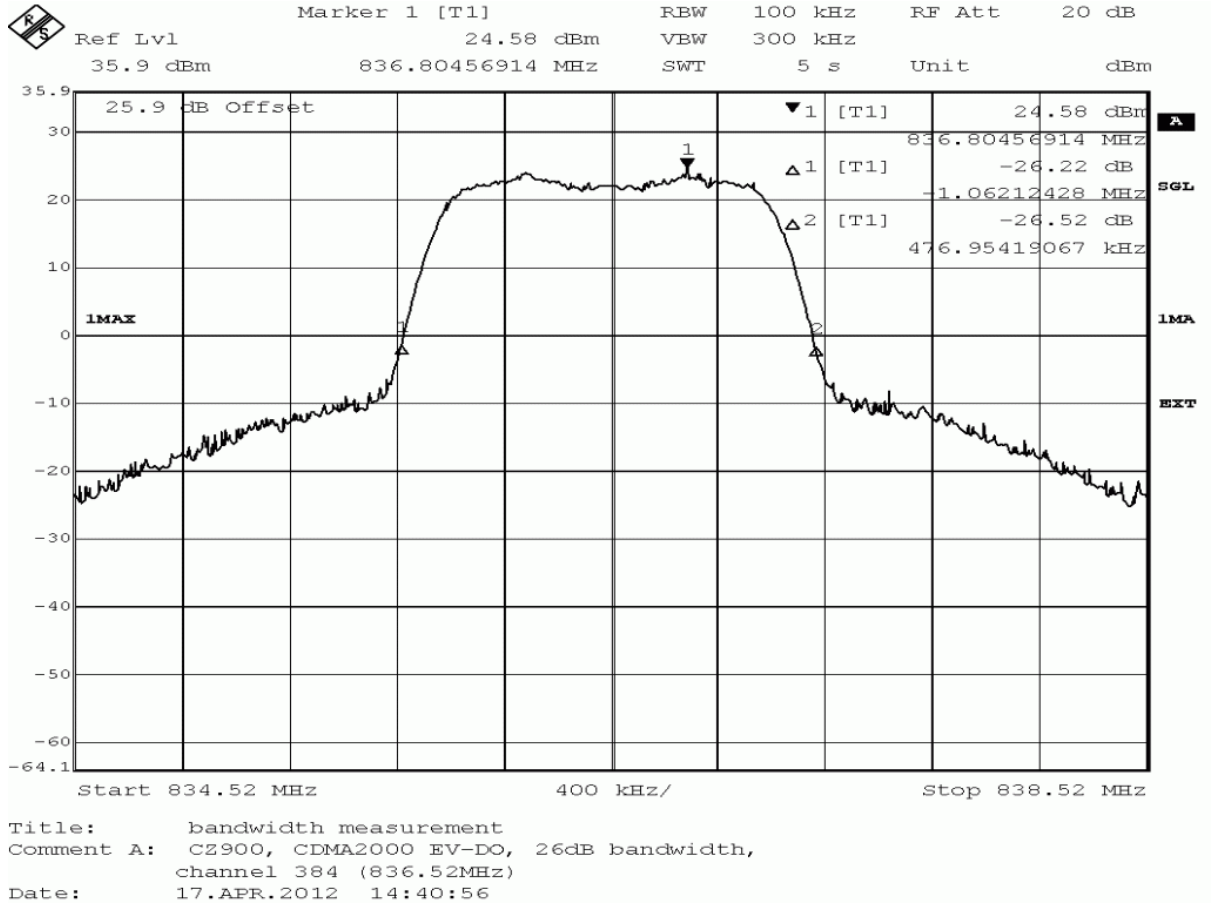

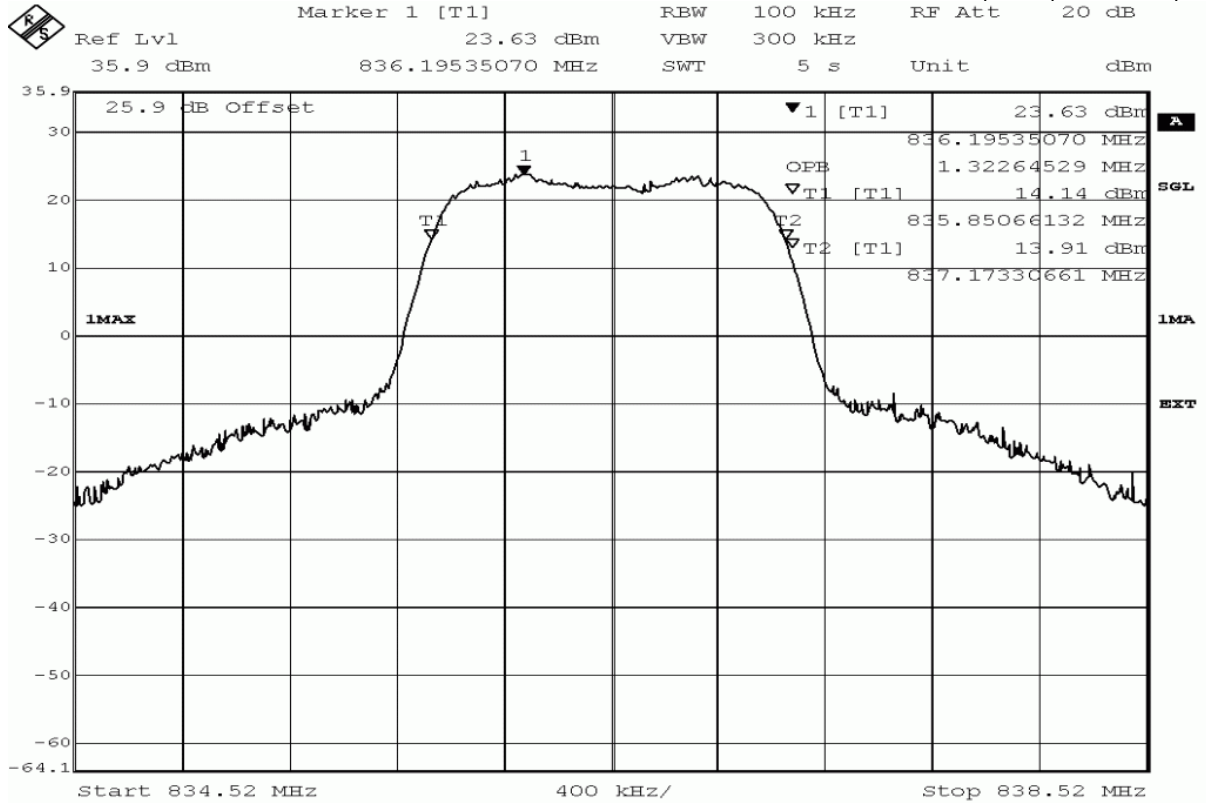

Title: bandwidth measurement
 Comment A: CZ900, CDMA2000 EV-DO, occupied bandwidth (99%),
 channel 384 (836.52MHz)
 Date: 17.APR.2012 14:41:14



detector	trace	resolution bandwidth /kHz	type of measurement	measured value /kHz	verdict
peak	maxhold	100	-26dB bandwidth	1539.1	passed
peak	maxhold	100	99% bandwidth	1322.6	passed



Reference: MDE_CINTE_1203_FCC22b_V1

acc. Title 47 CFR chapter I part 22 subpart H

3.5.6 22.6 Band edge compliance §2.1053, §22.917

Test: 22.6; Frequency Band = BC0, Mode = CDMA2000, Channel = 1013, Frequency = 824.7MHz

<i>Result:</i>	Passed
<i>Setup No.:</i>	B01_cond
<i>Date of Test:</i>	2012/04/17 11:47
<i>Body:</i>	FCC47CFRChIPART22PUBLIC MOBILE SERVICES
<i>Test Specification:</i>	FCC part 2 and 22

Detailed Results:



Ref Lvl	Marker 1 [T1]	RBW	10 kHz	RF Att	30 dB
26.5 dBm	-17.68 dBm	VBW	10 kHz		
	823.99989980 MHz	SWT	10 s	Unit	dBm

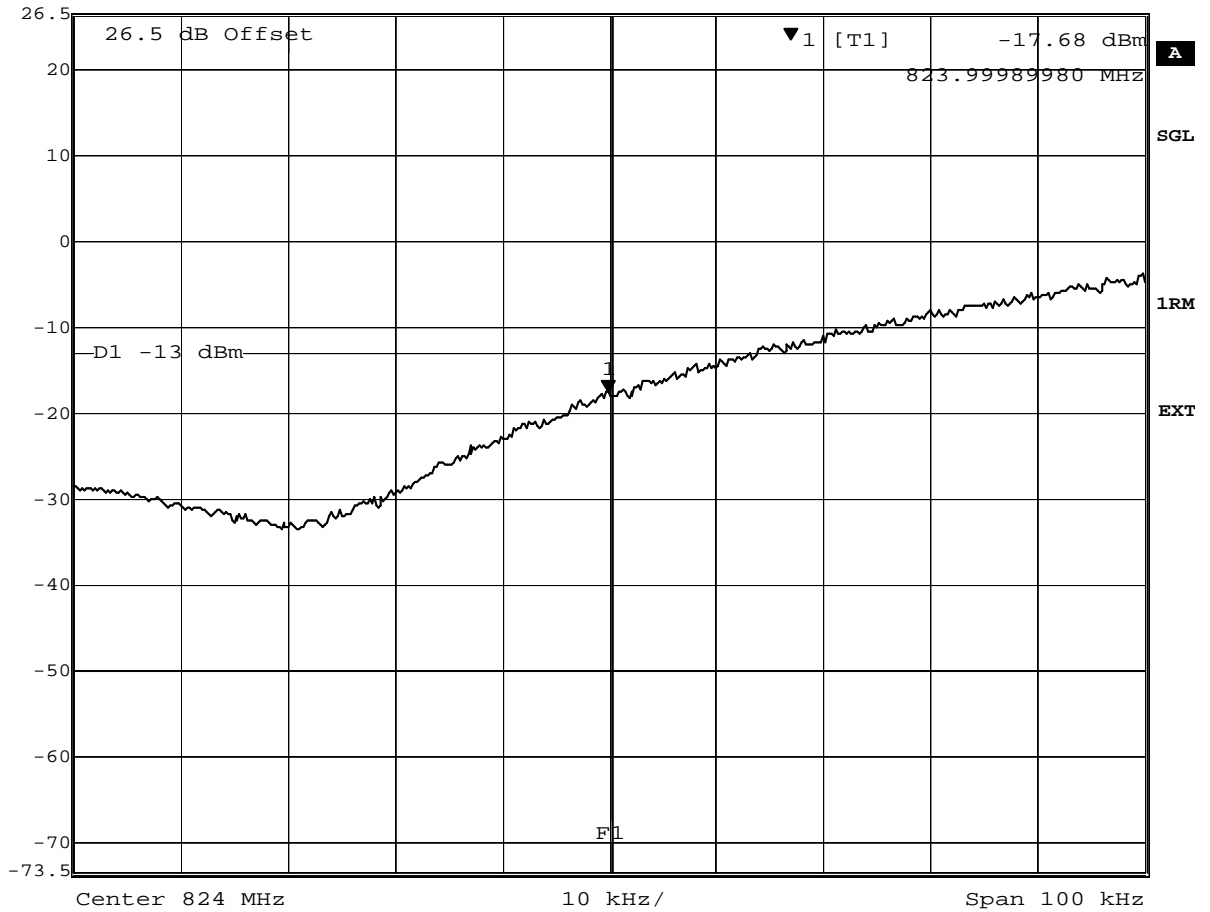

Date: 16.APR.2012 23:04:17

added by operator

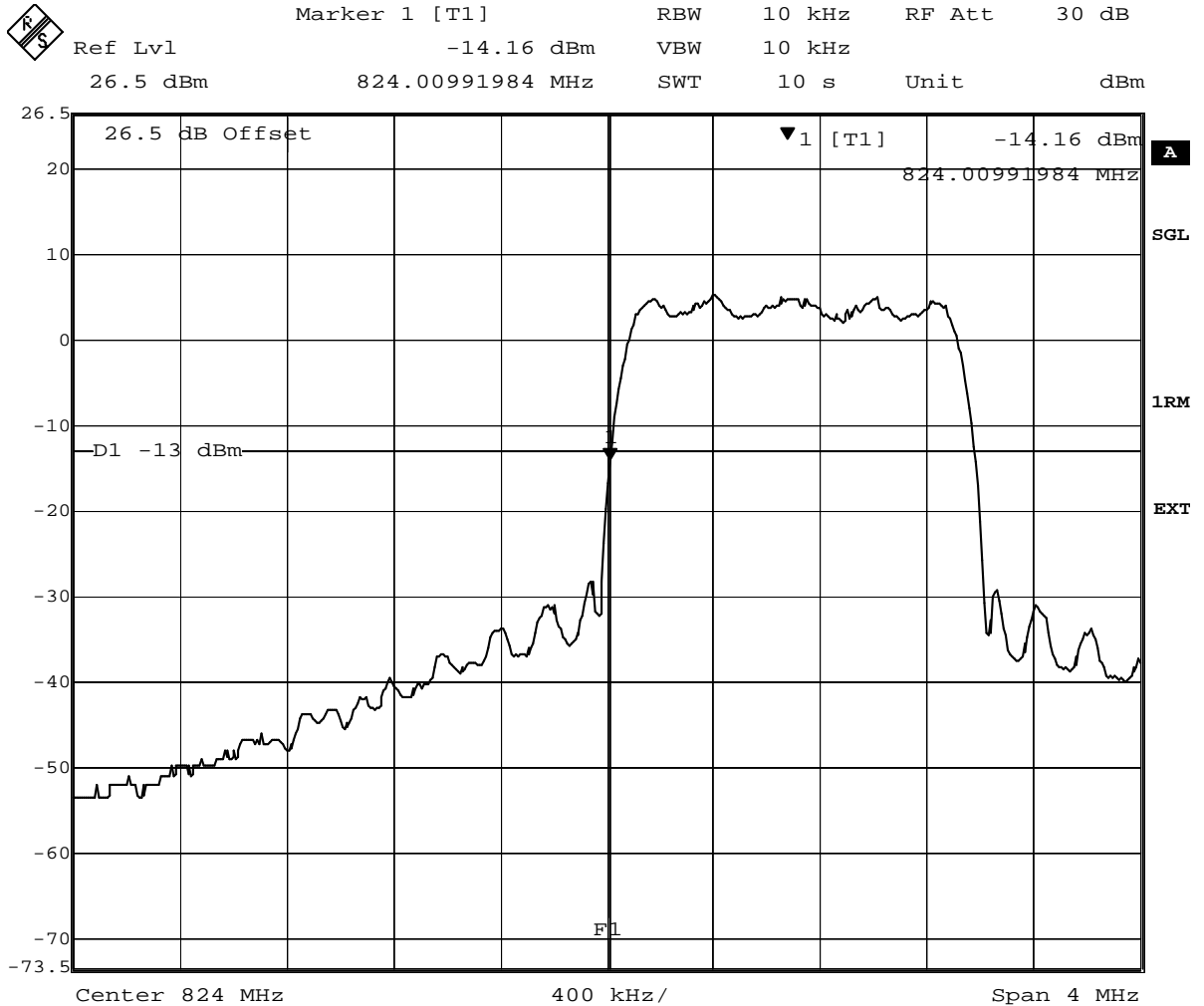

Date: 16.APR.2012 23:02:49

added by operator

detector	trace	resolution bandwidth /kHz	frequency /MHz	peak value /dBm	margin to limit /dB	limit /dBm	verdict
rms	maxhold	10	824.000	-17.9	4.9	-13.0	passed
corrected	RBW	12	824.000	-16.9	3.9	-13.0	passed

Test: 22.6; Frequency Band = BC0, Mode = CDMA2000, Channel = 777, Frequency = 848.3MHz

Result: Passed
 Setup No.: B01_cond
 Date of Test: 2012/04/17 11:47
 Body: FCC47CFRChIPART22PUBLIC MOBILE SERVICES
 Test Specification: FCC part 2 and 22

Detailed Results:



Ref Lvl	Marker 1 [T1]	RBW	10 kHz	RF Att	30 dB
26.5 dBm	-15.02 dBm	VBW	10 kHz		
	849.00000000 MHz	SWT	10 s	Unit	dBm

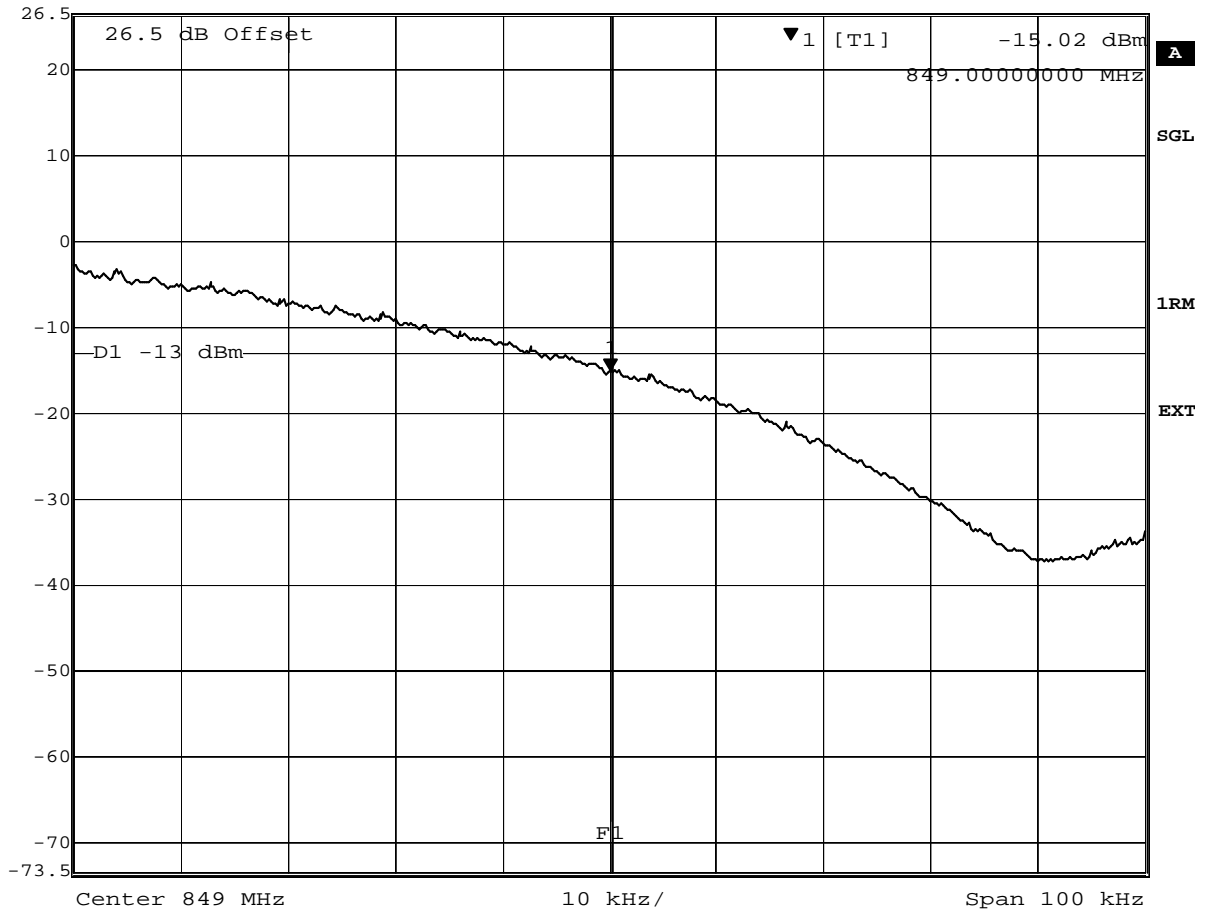

Date: 16.APR.2012 23:01:00

added by operator

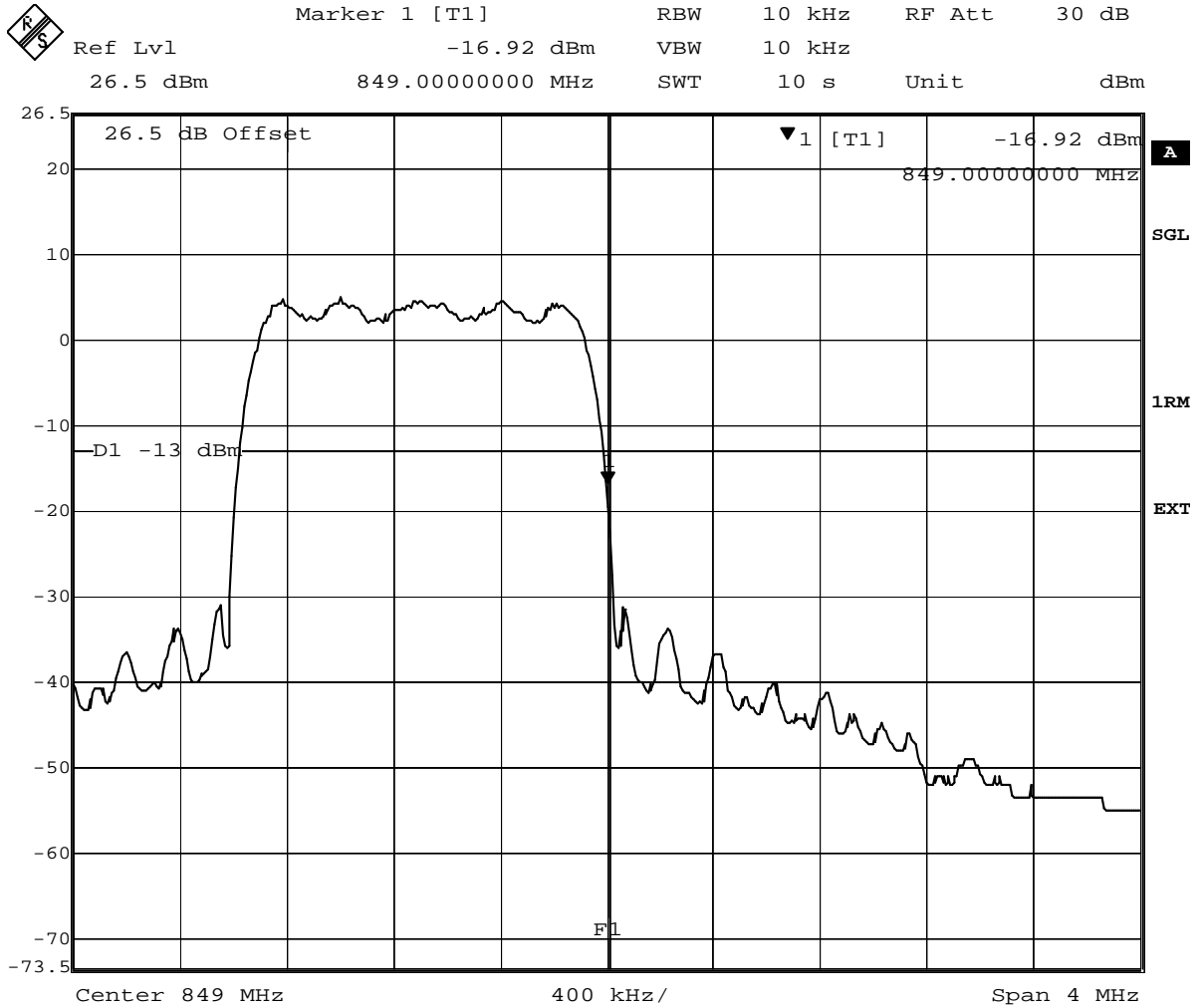

Date: 16.APR.2012 22:59:44

added by operator

detector	trace	resolution bandwidth /kHz	frequency /MHz	peak value /dBm	margin to limit /dB	limit /dBm	verdict
rms	maxhold	10	849.000	-14.1	1.1	-13.0	passed
corrected	RBW	12	849.000	-31.1	0.1	-13.0	passed

Test: 22.6; Frequency Band = BC0, Mode = CDMA2000_EV-DO, Channel = 1013, Frequency = 824.7MHz

Result: Passed
 Setup No.: B01_cond
 Date of Test: 2012/04/17 11:47
 Body: FCC47CFRChIPART22PUBLIC MOBILE SERVICES
 Test Specification: FCC part 2 and 22

Detailed Results:



Ref Lvl	Marker 1 [T1]	RBW	10 kHz	RF Att	30 dB
26.5 dBm	-17.18 dBm	VBW	10 kHz		
	824.00000000 MHz	SWT	10 s	Unit	dBm

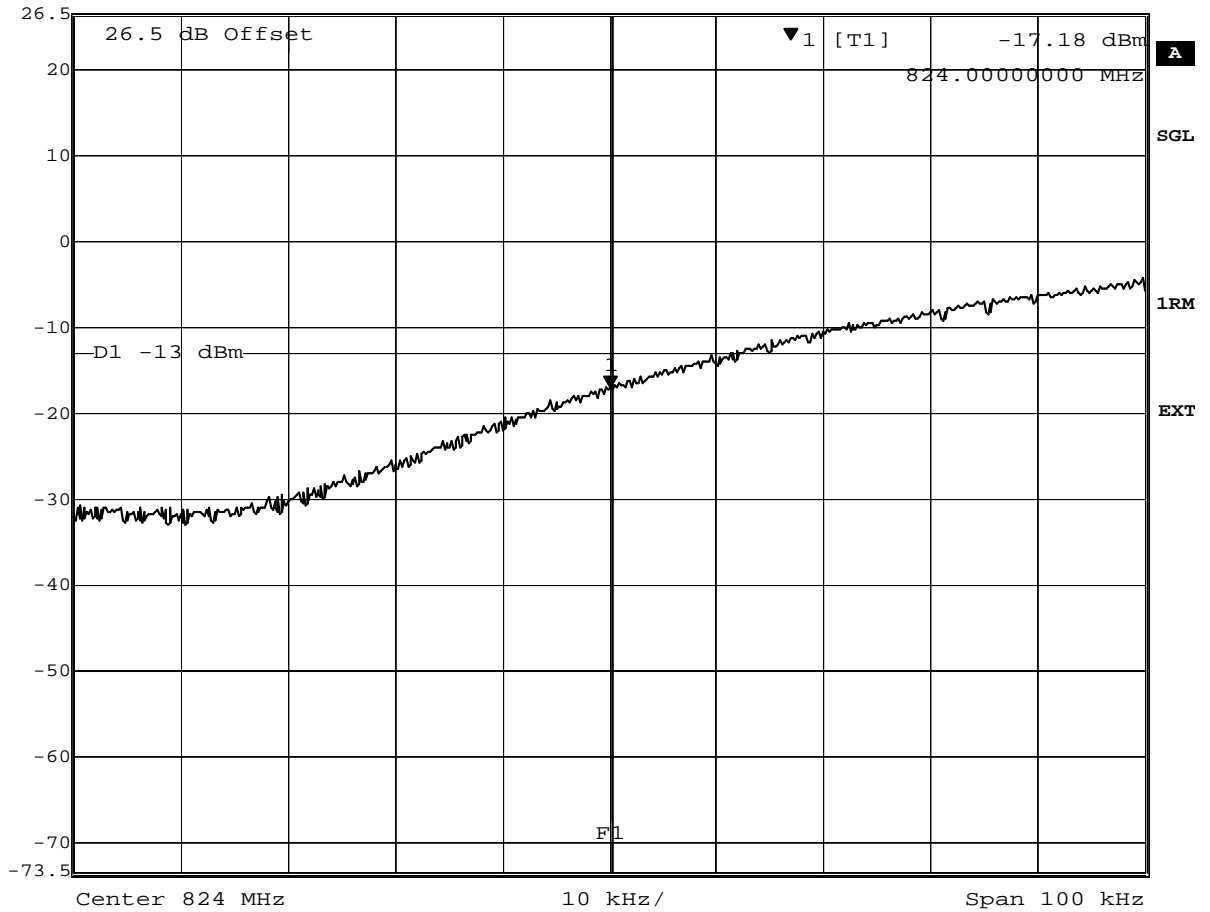

Date: 16.APR.2012 22:01:36

added by operator

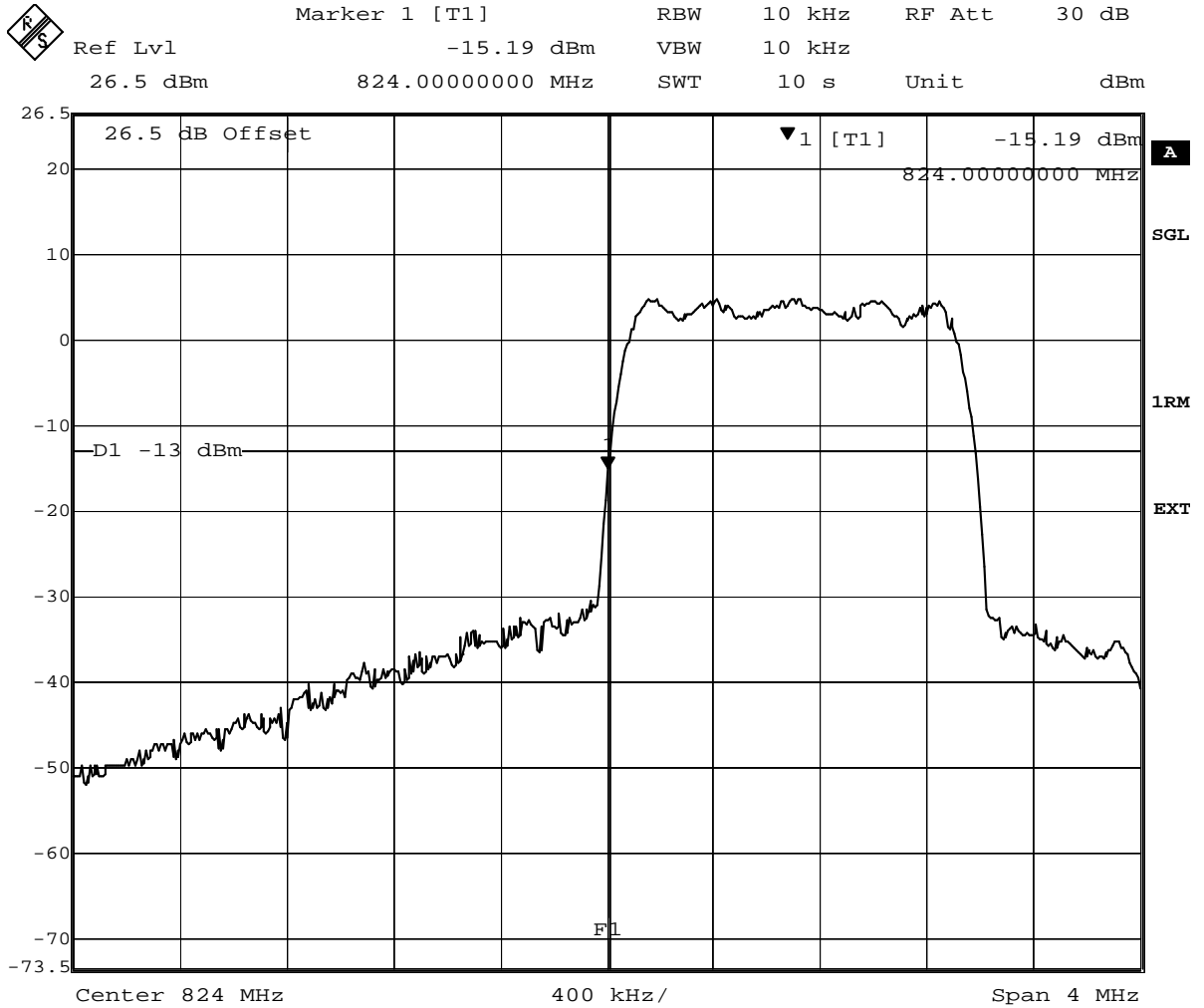

Date: 16.APR.2012 22:03:46

added by operator

detector	trace	resolution bandwidth /kHz	frequency /MHz	peak value /dBm	margin to limit /dB	limit /dBm	verdict
rms	maxhold	10	824.000	-17.2	4.2	-13.0	passed
corrected	RBW	12	824.000	-16.2	3.2	-13.0	passed

Test: 22.6; Frequency Band = BC0, Mode = CDMA2000_EV-DO, Channel = 777, Frequency = 848.3MHz

Result: Passed
 Setup No.: B01_cond
 Date of Test: 2012/04/17 11:47
 Body: FCC47CFRChIPART22PUBLIC MOBILE SERVICES
 Test Specification: FCC part 2 and 22

Detailed Results:



Ref Lvl	Marker 1 [T1]	RBW	10 kHz	RF Att	30 dB
26.5 dBm	-14.13 dBm	VBW	10 kHz		
	849.00060120 MHz	SWT	10 s	Unit	dBm

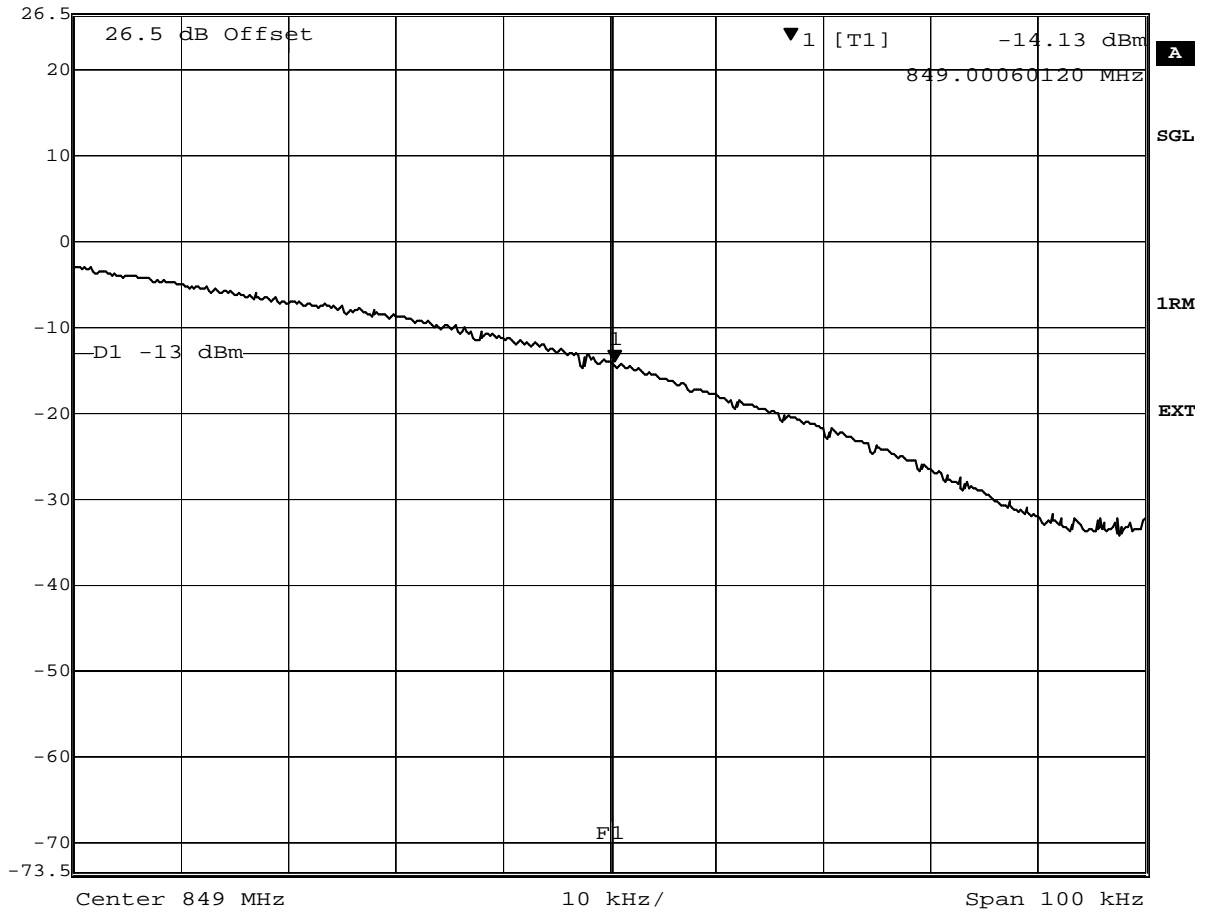

Date: 16.APR.2012 21:54:05

added by operator

acc. Title 47 CFR chapter I part 22 subpart H

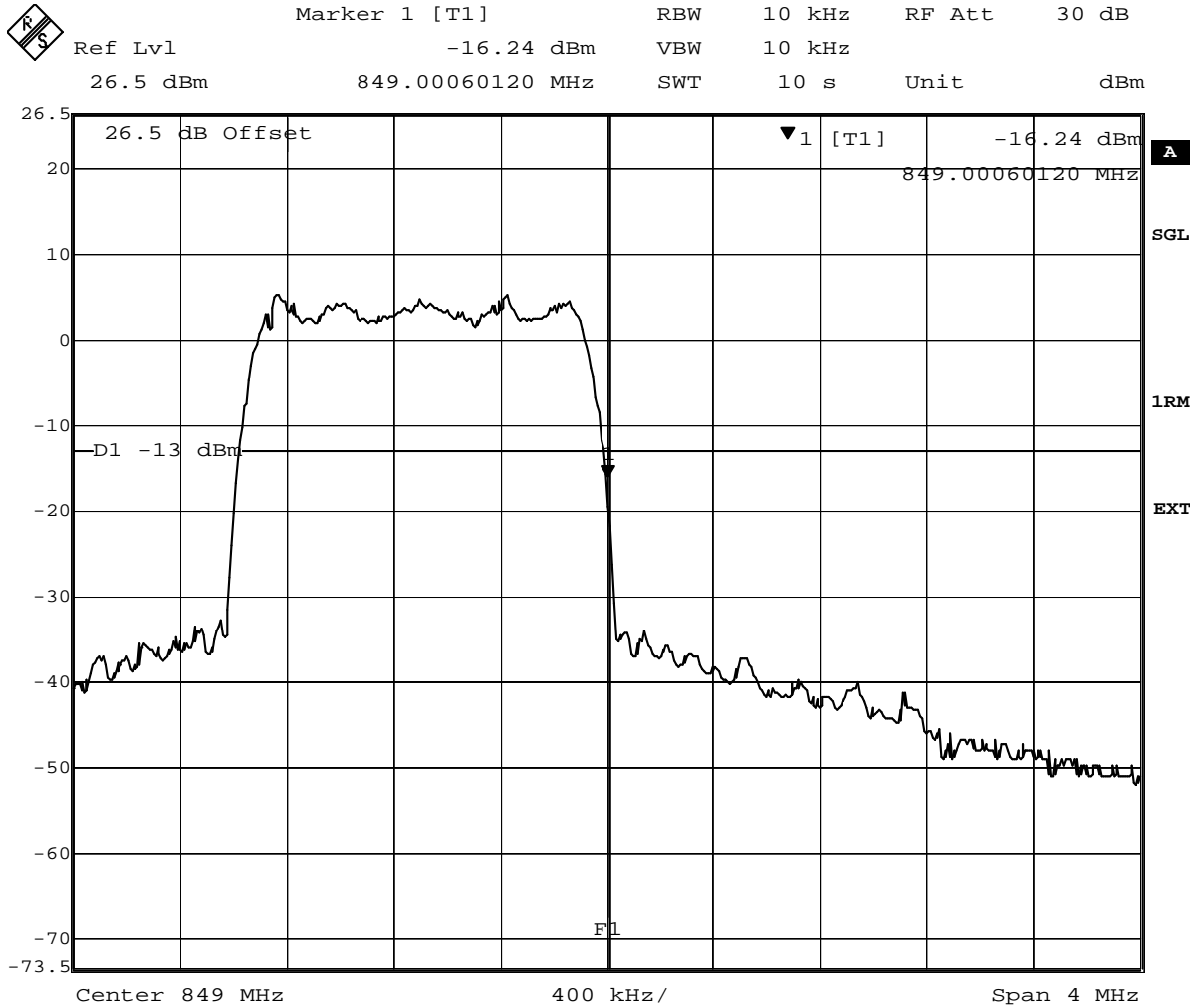

Date: 16.APR.2012 21:55:44

added by operator

detector	trace	resolution bandwidth /kHz	frequency /MHz	peak value /dBm	margin to limit /dB	limit /dBm	verdict
rms	maxhold	10	849.000	-15	2	-13.0	passed
corrected	RBW	12	849.000	-14	1	-13.0	passed

4 Test Equipment Details

4.1 List of Used Test Equipment

The calibration, hardware and software states are shown for the testing period.

Test Equipment Anechoic Chamber

Lab ID:	Lab 1
Manufacturer:	Frankonia
Description:	Anechoic Chamber for radiated testing
Type:	10.58x6.38x6.00 m ³

Single Devices for Anechoic Chamber

Single Device Name	Type	Serial Number	Manufacturer
Air compressor	none	-	Atlas Copco
Anechoic Chamber	10.58 x 6.38 x 6.00 m ³	none	Frankonia
	<i>Calibration Details</i>		<i>Last Execution Next Exec.</i>
	FCC listing 96716 3m Part15/18		2011/01/11 2014/01/10
	IC listing 3699A-1 3m		2011/02/07 2014/02/06
Controller Maturo	MCU	961208	Maturo GmbH
EMC camera	CE-CAM/1	-	CE-SYS
EMC camera Nr.2	CCD-400E	0005033	Mitsubishi
Filter ISDN	B84312-C110-E1		Siemens&Matsushita
Filter Universal 1A	BB4312-C30-H3	-	Siemens&Matsushita

Test Equipment Auxiliary Equipment for Radiated emissions

Lab ID:	Lab 1
Description:	Equipment for emission measurements
Serial Number:	see single devices

Single Devices for Auxiliary Equipment for Radiated emissions

Single Device Name	Type	Serial Number	Manufacturer
Antenna mast	AS 620 P	620/37	HD GmbH
Biconical dipole	VUBA 9117	9117-108	Schwarzbeck
	<i>Calibration Details</i>		<i>Last Execution Next Exec.</i>
	Standard Calibration		2008/10/27 2013/10/26
	Standard Calibration		2012/01/18 2015/01/17
Broadband Amplifier 18MHz-26GHz	JS4-18002600-32-5P	849785	Miteq
	<i>Calibration Details</i>		<i>Last Execution Next Exec.</i>
	Path Calibration		2011/11/15 2012/05/14
Broadband Amplifier 1GHz-4GHz	AFS4-01000400-1Q-10P-4	-	Miteq
	<i>Calibration Details</i>		<i>Last Execution Next Exec.</i>
	Path Calibration		2011/11/15 2012/05/14
Broadband Amplifier 30MHz-18GHz	JS4-00101800-35-5P	896037	Miteq
	<i>Calibration Details</i>		<i>Last Execution Next Exec.</i>
	Path Calibration		2011/11/15 2012/05/14
Cable "ESI to EMI Antenna"	EcoFlex10	W18.01- 2+W38.01-2	Kabel Kusch

Single Devices for Auxiliary Equipment for Radiated emissions (continued)

<i>Single Device Name</i>	<i>Type</i>	<i>Serial Number</i>	<i>Manufacturer</i>	
	<i>Calibration Details</i>		<i>Last Execution</i>	<i>Next Exec.</i>
	Path Calibration		2011/11/15	2012/05/14
Cable "ESI to Horn Antenna"	UFB311A+UFB293C	W18.02-2+W38.02-2	Rosenberger Micro-Coax	
	<i>Calibration Details</i>		<i>Last Execution</i>	<i>Next Exec.</i>
	Path Calibration		2011/11/15	2012/05/14
Double-ridged horn	HF 906	357357/001	Rohde & Schwarz GmbH & Co. KG	
	<i>Calibration Details</i>		<i>Last Execution</i>	<i>Next Exec.</i>
	Standard Calibration		2009/04/16	2012/04/15
	Standard Calibration		2012/05/18	2015/05/17
Double-ridged horn	HF 906	357357/002	Rohde & Schwarz GmbH & Co. KG	
	<i>Calibration Details</i>		<i>Last Execution</i>	<i>Next Exec.</i>
	Standard Calibration		2009/04/28	2012/04/27
High Pass Filter	4HC1600/12750-1.5-KK	9942011	Trilithic	
	<i>Calibration Details</i>		<i>Last Execution</i>	<i>Next Exec.</i>
	Path Calibration		2011/11/15	2012/05/14
High Pass Filter	5HC2700/12750-1.5-KK	9942012	Trilithic	
	<i>Calibration Details</i>		<i>Last Execution</i>	<i>Next Exec.</i>
	Path Calibration		2011/11/15	2012/05/14
High Pass Filter	5HC3500/12750-1.2-KK	200035008	Trilithic	
	<i>Calibration Details</i>		<i>Last Execution</i>	<i>Next Exec.</i>
	Path Calibration		2011/11/15	2012/05/14
High Pass Filter	WHKX 7.0/18G-8SS	09	Wainwright	
	<i>Calibration Details</i>		<i>Last Execution</i>	<i>Next Exec.</i>
	Path Calibration		2011/11/15	2012/05/14
Log.-per. Antenna	HL 562 Ultralog	830547/003	Rohde & Schwarz GmbH & Co. KG	
	<i>Calibration Details</i>		<i>Last Execution</i>	<i>Next Exec.</i>
	Standard Calibration		2009/05/27	2012/05/26
Loop Antenna	HFH2-Z2	829324/006	Rohde & Schwarz GmbH & Co. KG	
	<i>Calibration Details</i>		<i>Last Execution</i>	<i>Next Exec.</i>
	Standard calibration		2011/10/27	2014/10/26
Pyramidal Horn Antenna 26,5 GHz	3160-09	00083069	EMCO Elektronik GmbH	
Pyramidal Horn Antenna 40 GHz	3160-10	00086675	EMCO Elektronik GmbH	
Tilt device Maturo (Rohacell)	Antrieb TD1.5-10kg	TD1.5-10kg/024/3790709	Maturo GmbH	



Test Equipment Auxiliary Test Equipment

Lab ID: Lab 1, Lab 2
Manufacturer: see single devices
Description: Single Devices for various Test Equipment
Type: various
Serial Number: none

Single Devices for Auxiliary Test Equipment

<i>Single Device Name</i>	<i>Type</i>	<i>Serial Number</i>	<i>Manufacturer</i>
Broadband Power Divider N (Aux)	1506A / 93459	LM390	Weinschel Associates
Broadband Power Divider SMA	WA1515	A855	Weinschel Associates
Digital Multimeter 03 (Multimeter)	Fluke 177	86670383	Fluke Europe B.V.
	<i>Calibration Details</i>		<i>Last Execution</i> <i>Next Exec.</i>
	Customized calibration		2011/10/19 2013/10/18
Fibre optic link Satellite (Aux)	FO RS232 Link	181-018	Pontis
Fibre optic link Transceiver (Aux)	FO RS232 Link	182-018	Pontis
Isolating Transformer	LTS 604	1888	Thalheimer Transformatorenwerke GmbH
Notch Filter Ultra Stable (Aux)	WRCA800/960-6EEK	24	Wainwright
Vector Signal Generator	SMIQ 03B	832492/061	Rohde & Schwarz GmbH & Co.KG

Test Equipment Digital Signalling Devices

Lab ID: Lab 1, Lab 2
Description: Signalling equipment for various wireless technologies.

Single Devices for Digital Signalling Devices

Single Device Name	Type	Serial Number	Manufacturer
Bluetooth Signalling Unit CBT	CBT	100589	Rohde & Schwarz GmbH & Co. KG
	<i>Calibration Details</i>		<i>Last Execution</i> <i>Next Exec.</i>
	Standard calibration		2011/11/24 2014/11/23
CMW500	CMW500	107500	Rohde & Schwarz GmbH & Co.KG
	<i>Calibration Details</i>		<i>Last Execution</i> <i>Next Exec.</i>
	Initial factory calibration		2012/01/26 2014/01/25
	<i>HW/SW Status</i>		<i>Date of Start</i> <i>Date of End</i>
	Firmware: V.2.01.25		2012/04/20
	Tools: V 7.53.3.362		
	License Proxy: V 6.10.9.14		
	Rel-7:		
	KC42x ver. 11.36.0.1		
	Rel-8:		
KC501: 1.04.5.24, 1.04.8.31, 1.05.1.34, 1.05.5.39, 1.06.5.44, 1.06.7.47, 1.07.0.49, 1.07.2.51			
KC503: 1.04.8.4, 1.05.1.6, 1.05.5.10, 1.05.6.12, 1.06.7.15, 1.07.0.17, 1.07.2.18			
KC507: 1.05.0.3, 1.06.0.7, 1.06.5.11, 1.07.0.13			
KC508: 1.05.0.2, 1.06.0.6, 1.06.5.11, 1.07.0.13			
KC551: 1.04.1.4, 1.04.8.7, 1.04.9.8, 1.05.5.9, 1.06.5.11, 1.06.7.13, 1.07.0.15, 1.07.2.17			
KC553: 1.04.8.4, 1.04.9.6, 1.05.5.7, 1.06.5.9, 1.06.7.11, 1.07.0.13, 1.07.2.14			
InterLab® LSIM Test Solution 1.6.7.4			
InterLab® LSAT Test Solution 1.6.7.4			

Universal Radio Communication Tester	CMU 200	102366	Rohde & Schwarz GmbH & Co. KG
	<i>Calibration Details</i>		<i>Last Execution</i> <i>Next Exec.</i>
	Standard calibration		2011/05/26 2013/05/25
	<i>HW/SW Status</i>		<i>Date of Start</i> <i>Date of End</i>
Hardware:		2007/07/16	
B11, B21V14, B21-2, B41, B52V14, B52-2, B53-2, B56V14, B68 3v04, PCMCIA, U65V04			
Software:			
K21 4v21, K22 4v21, K23 4v21, K24 4v21, K42 4v21, K43 4v21, K53 4v21, K56 4v22, K57 4v22, K58 4v22, K59 4v22, K61 4v22, K62 4v22, K63 4v22, K64 4v22, K65 4v22, K66 4v22, K67 4v22, K68 4v22, K69 4v22			
Firmware:			
µP1 8v50 02.05.06			

Universal Radio Communication Tester	CMU 200	837983/052	Rohde & Schwarz GmbH & Co. KG
	<i>Calibration Details</i>		<i>Last Execution</i> <i>Next Exec.</i>
	Standard calibration		2011/12/07 2014/12/06
<i>HW/SW Status</i>		<i>Date of Start</i> <i>Date of End</i>	

Single Devices for Digital Signalling Devices (continued)

<i>Single Device Name</i>	<i>Type</i>	<i>Serial Number</i>	<i>Manufacturer</i>
	HW options: B11, B21V14, B21-2, B41, B52V14, B52-2, B53-2, B54V14, B56V14, B68 3v04, B95, PCMCIA, U65V02 SW options: K21 4v11, K22 4v11, K23 4v11, K24 4v11, K27 4v10, K28 4v10, K42 4v11, K43 4v11, K53 4v10, K65 4v10, K66 4v10, K68 4v10, Firmware: µP1 8v40 01.12.05 ---		2007/01/02
	SW: K62, K69		2008/11/03

Test Equipment Emission measurement devices

Lab ID: Lab 1
Description: Equipment for emission measurements
Serial Number: see single devices

Single Devices for Emission measurement devices

<i>Single Device Name</i>	<i>Type</i>	<i>Serial Number</i>	<i>Manufacturer</i>
Personal Computer	Dell	30304832059	Dell
Power Meter	NRVD	828110/016	Rohde & Schwarz GmbH & Co.KG
	<i>Calibration Details</i>		<i>Last Execution Next Exec.</i>
	Standard calibration		2012/05/22 2013/05/21
	Standard calibration		2011/05/03 2012/05/02
Sensor Head A	NRV-Z1	827753/005	Rohde & Schwarz GmbH & Co.KG
	<i>Calibration Details</i>		<i>Last Execution Next Exec.</i>
	Standard calibration		2012/05/21 2013/05/20
	Standard calibration		2011/05/02 2012/05/01
Signal Generator	SMR 20	846834/008	Rohde & Schwarz GmbH & Co. KG
	<i>Calibration Details</i>		<i>Last Execution Next Exec.</i>
	standard calibration		2011/05/12 2014/05/11
Spectrum Analyzer	ESIB 26	830482/004	Rohde & Schwarz GmbH & Co. KG
	<i>Calibration Details</i>		<i>Last Execution Next Exec.</i>
	Standard Calibration		2011/12/05 2013/12/04
	<i>HW/SW Status</i>		<i>Date of Start Date of End</i>
	Firmware-Update 4.34.4 from 3.45 during calibration		2009/12/03



Test Equipment Radio Lab Test Equipment

Lab ID: Lab 2
Description: Radio Lab Test Equipment

Single Devices for Radio Lab Test Equipment

Single Device Name	Type	Serial Number	Manufacturer
Broadband Power Divider SMA	WA1515	A856	Weinschel Associates
Coax Attenuator 10dB SMA 2W	4T-10	F9401	Weinschel Associates
Coax Attenuator 10dB SMA 2W	56-10	W3702	Weinschel Associates
Coax Attenuator 10dB SMA 2W	56-10	W3711	Weinschel Associates
Coax Cable Huber&Suhner	Sucotest 2,0m		Rosenberger Micro-Coax
Coax Cable Rosenberger Micro Coax FA210A0010003030 SMA/SMA 1,0m	FA210A0010003030	54491-2	Rosenberger Micro-Coax
Power Meter	NRVD	828110/016	Rohde & Schwarz GmbH & Co.KG
	<i>Calibration Details</i>		<i>Last Execution Next Exec.</i>
	Standard calibration		2012/05/22 2013/05/21
	Standard calibration		2011/05/03 2012/05/02
RF Step Attenuator RSP	RSP	833695/001	Rohde & Schwarz GmbH & Co.KG
Rubidium Frequency Standard	Datum, Model: MFL	2689/001	Datum-Beverly
	<i>Calibration Details</i>		<i>Last Execution Next Exec.</i>
	Standard calibration		2011/06/17 2012/06/16
Sensor Head A	NRV-Z1	827753/005	Rohde & Schwarz GmbH & Co.KG
	<i>Calibration Details</i>		<i>Last Execution Next Exec.</i>
	Standard calibration		2012/05/21 2013/05/20
	Standard calibration		2011/05/02 2012/05/01
Signal Generator	SMY02	829309/018	Rohde & Schwarz GmbH & Co. KG
	<i>Calibration Details</i>		<i>Last Execution Next Exec.</i>
	Standard calibration		2011/11/04 2014/11/03
Signal Generator SME	SME03	827460/016	Rohde & Schwarz GmbH & Co.KG
	<i>Calibration Details</i>		<i>Last Execution Next Exec.</i>
	Standard calibration		2011/11/25 2014/11/24
Signal Generator SMP	SMP02	836402/008	Rohde & Schwarz GmbH & Co. KG
Spectrum Analyser	FSIQ26	840061/005	Rohde & Schwarz GmbH & Co. KG
	<i>Calibration Details</i>		<i>Last Execution Next Exec.</i>
	Standard calibration		2011/02/10 2013/02/09
Temperature Chamber Vötsch 03	VT 4002	58566002150010	Vötsch



Single Devices for Radio Lab Test Equipment (continued)

<i>Single Device Name</i>	<i>Type</i>	<i>Serial Number</i>	<i>Manufacturer</i>	
	<i>Calibration Details</i>		<i>Last Execution</i>	<i>Next Exec.</i>
	Customized calibration		2012/03/12	2014/03/11
	Specific calibration		2010/03/16	2012/03/15

4.2 Laboratory Environmental Conditions

<i>Laboratory</i>	<i>Date</i>	<i>Temperature</i>	<i>Humidity</i>	<i>Air Pressure</i>
Lab 1	2012/03/13	23 °C	36 %	1028 hPa
	2012/03/20	24 °C	33 %	1030 hPa
	2012/04/25	24 °C	33 %	1030 hPa
	2012/04/27	25 °C	34 %	1010 hPa
	2012/05/24	26 °C	47 %	1018 hPa
Lab 2	2012/04/17	24 °C	32 %	1015 hPa
	2012/04/18	24 °C	32 %	1015 hPa



Reference: MDE_CINTE_1203_FCC22b_V1

acc. Title 47 CFR chapter I part 22 subpart H

5 Annex

5.1 Additional Information for Report



Summary of Test Results

The EUT complied with all performed tests as listed in the summary section of this report.

Technical Report Summary

Type of Authorization :

Certification for a GSM/WCDMA/CDMA2000 cellular radiotelephone device

Applicable FCC Rules

Prepared in accordance with the requirements of FCC Rules and Regulations as listed in 47 CFR Ch.1 Parts 0 to 69. The following subparts are applicable to the results in this test report.

Part 2, Subpart J - Equipment Authorization Procedures, Certification

- § 2.1046 Measurement required: RF power output
- § 2.1049 Measurement required: Occupied bandwidth
- § 2.1051 Measurement required: Spurious emissions at antenna terminals
- § 2.1053 Measurement required: Field strength of spurious radiation
- § 2.1055 Measurement required: Frequency stability
- § 2.1057 Frequency spectrum to be investigated

Part 22, Subpart C – Operational and Technical Requirements

- § 22.355 Frequency tolerance

Part 22, Subpart H – Cellular Radiotelephone Service

- § 22.913 Effective radiated power limits
- § 22.917 Emission limitations for cellular equipment

additional documents

ANSI TIA-603-C-2004

Description of Methods of Measurements

RF Power Output

Standard FCC Part 22, Subpart H

The test was performed according to: FCC §2.1046

Test Description (conducted measurement procedure)

- 1) The EUT was coupled to a Spectrum Analyser and a Digital Communication Tester through a Power Divider. Refer to chapter "Setup Drawings".
 - 2) The total insertion losses for signal path 1 and signal path 2 were measured. The values were used to correct the readings from the Spectrum Analyser and the Digital Communication Tester.
 - 3) A call was established on a Traffic Channel between the EUT and the Digital Communication Tester.
- Important Settings:
- Channel (Frequency): please refer to the detailed results
- 4) The transmitted power of the EUT was recorded by using a CMW500.

Test Description (radiated measurement procedure)

- 1) The EUT was placed inside an anechoic chamber. Refer to chapter "Setup Drawings". The EUT was coupled to a Digital Communication Tester which was located outside the chamber via a small signalling antenna.
 - 2) A call was established on a Traffic Channel between the EUT and the Digital Communication Tester.
- Important Settings:
- Output Power: Maximum
 - Channel: please refer to the detailed results
- 3) A substitution procedure is used so that the readings from the spectrum analyser are corrected and represent directly the equivalent radiated power (related to a $\lambda/2$ dipole).
 - 4) The output power was measured in both vertical and horizontal antenna polarisation during the call is established on the lowest channel, mid channel and on the highest channel. To find the worst case power all orientations (X, Y, Z) of the EUT have been measured.
 - 5) The test procedure according to TIA-603-C-2004 has been considered.

Test Requirements / Limits

§2.1046 Measurements Required: RF Power Output

(a) For transmitters other than single sideband, independent sideband and controlled carrier radiotelephone, power output shall be measured at the RF output terminals when the transmitter is adjusted in accordance with the tune-up procedure to give the values of current and voltage on the circuit elements specified in § 2.1033(c)(8). The electrical characteristics of the output terminals when this test is made shall be stated.

§22.913 Effective radiated power limits

(a)(2) Maximum ERP. ... The ERP of mobile transmitters and auxiliary test transmitters must not exceed 7 Watts.

Emission and Occupied Bandwidth

Standard FCC Part 22, Subpart H

The test was performed according to: FCC §2.1049

Test Description

- 1) The EUT was coupled to a Spectrum Analyser and a Digital Communication Tester through a Power Divider. Refer to chapter "Setup Drawings".
 - 2) The total insertion losses for signal path 1 and signal path 2 were measured. The values were used to correct the readings from the Spectrum Analyser and the Digital Communication Tester.
 - 3) A call was established on a Traffic Channel between the EUT and the Digital Communication Tester.
- Important Settings:
- Output Power: Maximum
 - Channel: please refer to the detailed results
- 4) Important Analyser Settings:
 - Resolution Bandwidth: >1% of the manufacturer's stated occupied bandwidth
 - 5) The maximum spectral level of the modulated signal was recorded as the reference.
 - 6) The emission bandwidth is measured as follows:
the two furthest frequencies above and below the frequency of the maximum reference level where the spectrum is -26 dB down have to be found.

acc. Title 47 CFR chapter I part 22 subpart H

7) The occupied bandwidth (99% Bandwidth) is measured as follows:
the occupied bandwidth, that is the frequency bandwidth such that, below its lower and above its upper frequency limits, the mean powers are each equal to 0.5 percent of the total mean power.

Test Requirements / Limits

§ 2.1049 Measurements required: Occupied bandwidth

The occupied bandwidth, that is the frequency bandwidth such that, below its lower and above its upper frequency limits, the mean powers radiated are each equal to 0.5 percent of the total mean power radiated by a given emission shall be measured under the following conditions (as applicable):

(h) Transmitters employing digital modulation techniques - when modulated by an input signal such that its amplitude and symbol rate represent the maximum rated conditions under which the equipment will be operated. The signal shall be applied through any filter networks, pseudo-random generators or other devices required in normal service. Additionally, the occupied bandwidth shall be shown for operation with any devices used for modifying the spectrum when such devices are optional at the discretion of the user.

Spurious emissions at antenna terminals

Standard FCC Part 22, Subpart H

The test was performed according to FCC §2.1051

Test Description

1) The EUT was coupled to a Spectrum Analyser and a Digital Communication Tester through a Power Divider. Refer to chapter "Setup Drawings".

2) The total insertion losses for signal path 1 and signal path 2 were measured. The values were used to correct the readings from the Spectrum Analyser and the Digital Communication Tester.

3) A call was established on a Traffic Channel between the EUT and the Digital Communication Tester.

Important Settings:

- Output Power: Maximum
- Channel: please refer to the detailed results

4) Important Analyser Settings

- [Resolution Bandwidth]:

a) [$\geq 1\%$ of wanted signal bandwidth] in the Span of 1 MHz directly below and above the PCS-Band,

b) otherwise [100 kHz] (or [1 MHz] for accelerated sweep times)

c) [reduced resolution bandwidth] in case the curve of the analyser IF-Filter or the wanted EUT signal leads to an exceeding of the limit, in this case a correction factor was used

- Sweep Time: depending on the transmitting signal, the span and the resolution bandwidth

5) The spurious emissions peaks were measured in the frequency range from 9 kHz to 10 GHz (up to the 10th harmonic) during the call was established

Test Requirements / Limits

§ 2.1051 Spurious emissions at antenna terminals

The radio frequency voltage or power generated within the equipment and appearing on a spurious frequency shall be checked at the equipment output terminals when properly loaded with a suitable artificial antenna. Curves or equivalent data shall show the magnitude of each harmonic and other spurious emission that can be detected when the equipment is operated under the conditions specified in Sec. 2.1049 as appropriate. The magnitude of spurious emissions which are attenuated more than 20 dB below the permissible value need not be specified.

§ 2.1057 Frequency spectrum to be investigated.

(a) In all of the measurements set forth in Secs. 2.1051 and 2.1053, the spectrum shall be investigated from the lowest radio frequency signal generated in the equipment, without going below 9 kHz, up to at least the frequency shown below:

(1) If the equipment operates below 10 GHz: to the tenth harmonic of the highest fundamental frequency or

acc. Title 47 CFR chapter I part 22 subpart H

to 40 GHz, whichever is lower.

(b) Particular attention should be paid to harmonics and subharmonics of the carrier frequency as well as to those frequencies removed from the carrier by multiples of the oscillator frequency. Radiation at the frequencies of multiplier stages should also be checked.

(c) The amplitude of spurious emissions which are attenuated more than 20 dB below the permissible value need not be reported.

(d) Unless otherwise specified, measurements above 40 GHz shall be performed using a minimum resolution bandwidth of 1 MHz.

§ 22.917 Emission limitations for cellular equipment

(a) The power of any emission outside of the authorized operating frequency ranges must be attenuated below the transmitting power (P) by a factor of at least $43 + 10 \log(P)$ dB.

Remark of the test laboratory: This is calculated to be -13 dBm.

(b) Compliance with these rules is based on the use of measurement instrumentation employing a resolution bandwidth of 100 kHz or greater. In the 1 MHz bands immediately outside and adjacent to the frequency block a resolution bandwidth of at least one percent of the emission bandwidth of the fundamental emission of the transmitter may be employed. A narrower resolution bandwidth is permitted in all cases to improve measurement accuracy provided the measured power is integrated over the full required measurement bandwidth (i.e. 100 kHz or 1 percent of emission bandwidth, as specified). The emission bandwidth is defined as the width of the signal between two points, one below the carrier center frequency and one above the carrier center frequency, outside of which all emissions are attenuated at least 26 dB below the transmitter power.

(c) Licensees in this service may establish an alternative out of band emission limit to be used at specified band edge(s) in specified geographical areas [...].

(d) If any emission from a transmitter operating in this service results in interference to users of another radio service, the FCC may require a greater attenuation of that emission than specified in this section.

For reporting only spurious emission levels reaching to the 20dB margin to limit were noted.

Field strength of spurious radiation

Standard FCC Part 22, Subpart H

The test was performed according to: FCC §2.1053

Test Description

1) The EUT was placed inside an anechoic chamber. Refer to chapter "Setup Drawings". The EUT was coupled to a Digital Communication Tester which was located outside the chamber via a small signalling antenna.

2) A call was established on a Traffic Channel between the EUT and the Digital Communication Tester.

Important Settings:

- Output Power: Maximum

- Channel: please refer to the detailed results

3) A pre-calibration procedure is used so that the readings from the spectrum analyser are corrected and represent directly the equivalent radiated power (related to a $\lambda/2$ dipole).

4) All spurious radiation measurements were made with spectrum analyser and the appropriate calibrated antennas for the frequency range of 30 MHz to 10 GHz (up to the 10th harmonic of the transmit frequency). The frequency range from 9 kHz to 30 MHz has been examined during the conducted spurious emission measurements.

5) Important Analyser Settings

- [Resolution Bandwidth / Video Bandwidth]:

a) [3 kHz / 10 kHz] in the Span of 1 MHz directly below and above the Band,

b) [10 kHz / 30 kHz] in case the curve of the analyser IF-Filter leads to an exceeding of the limit, in this case a worst case correction factor of 20 dB (1 MHz -> 10 kHz) was used

c) [1 MHz / 3 MHz] otherwise

- Sweep Time: depending on the transmitting signal, the span and the resolution bandwidth

6) The spurious emissions peaks were measured in both vertical and horizontal antenna polarization during the call is established on the lowest channel, mid channel and on the highest channel. To find the worst case peaks all orientations (X, Y, Z) of the EUT have been measured.

Test Requirements / Limits

§ 2.1053 Measurements required: Field strength of spurious radiation.

Measurements shall be made to detect spurious emissions that may be radiated directly from the cabinet, control circuits, power leads, or intermediate circuit elements under normal conditions of installation and operation. Curves or equivalent data shall be supplied showing the magnitude of each harmonic and other spurious emission. For this test, single sideband, independent sideband, and controlled carrier transmitters shall be modulated under the conditions specified in paragraph (c) of Sec. 2.1049, as appropriate. For equipment operating on frequencies below 890 MHz, an open field test is normally required, with the measuring instrument antenna located in the far-field at all test frequencies. In the event it is either impractical or impossible to make open field measurements (e.g. a broadcast transmitter installed in a building) measurements will be accepted of the equipment as installed. Such measurements must be accompanied by a description of the site where the measurements were made showing the location of any possible source of reflections which might distort the field strength measurements. Information submitted shall include the relative radiated power of each spurious emission with reference to the rated power output of the transmitter, assuming all emissions are radiated from halfwave dipole antennas.

(b) The measurements specified in paragraph (a) of this section shall be made for the following equipment:

(2) All equipment operating on frequencies higher than 25 MHz.

§ 2.1057 Frequency spectrum to be investigated.

(a) In all of the measurements set forth in Secs. 2.1051 and 2.1053, the spectrum shall be investigated from the lowest radio frequency signal generated in the equipment, without going below 9 kHz, up to at least the frequency shown below:

(1) If the equipment operates below 10 GHz: to the tenth harmonic of the highest fundamental frequency or to 40 GHz, whichever is lower.

(b) Particular attention should be paid to harmonics and subharmonics of the carrier frequency as well as to those frequencies removed from the carrier by multiples of the oscillator frequency. Radiation at the frequencies of multiplier stages should also be checked.

(c) The amplitude of spurious emissions which are attenuated more than 20 dB below the permissible value need not be reported.

(d) Unless otherwise specified, measurements above 40 GHz shall be performed using a minimum resolution bandwidth of 1 MHz.

§ 22.917 Emission limitations for cellular equipment

(a) The power of any emission outside of the authorized operating frequency ranges must be attenuated below the transmitting power (P) by a factor of at least $43 + 10 \log(P)$ dB.

This is calculated to be -13 dBm (effective radiated power) which corresponds to 84.6 dB μ V/m (field strength) in a distance of 3 m.

(b) Compliance with these rules is based on the use of measurement instrumentation employing a resolution bandwidth of 100 kHz or greater. In the 1 MHz bands immediately outside and adjacent to the frequency block a resolution bandwidth of at least one percent of the emission bandwidth of the fundamental emission of the transmitter may be employed. A narrower resolution bandwidth is permitted in all cases to improve measurement accuracy provided the measured power is integrated over the full required measurement bandwidth (i.e. 100 kHz or 1 percent of emission bandwidth, as specified). The emission bandwidth is defined as the width of the signal between two points, one below the carrier center frequency and one above the carrier center frequency, outside of which all emissions are attenuated at least 26 dB below the transmitter power.

(c) Licensees in this service may establish an alternative out of band emission limit to be used at specified band edge(s) in specified geographical areas [...].

(d) If any emission from a transmitter operating in this service results in interference to users of another radio service, the FCC may require a greater attenuation of that emission than specified in this section.

For reporting only spurious emission levels reaching to the 20dB margin to limit were noted.

Frequency stability

Standard FCC Part 22, Subpart H

The test was performed according to FCC §2.1055

Test Description

- 1) The EUT was placed inside a temperature chamber.
 - 2) The EUT was coupled to a Digital Communication Tester. Refer to chapter "Setup Drawings".
 - 3) The climatic chamber was cycled down/up to a certain temperature, starting with the EUT minimum temperature.
 - 4) After the temperature was stabilized the EUT was switched on and a call was established on a Traffic Channel between the EUT and the Digital Communication Tester.
- Important Settings:
- Output Power: Maximum
 - Mid Channel
- 5) The frequency error of the EUT was recorded by using an internal measurement function of the Digital Communication Tester immediately after the call was established, five minutes after the call was established and ten minutes after the call was established.
 - 6) This measurement procedure was performed for temperature variation from -30°C to +50°C in increments of 10°C, if not otherwise stated in the detailed results.
- When the EUT did not operate at certain temperature levels, these measurements were left out.

Test Requirements / Limits

§2.1055 Measurements required: Frequency stability

- (a) The frequency stability shall be measured with variation of ambient temperature as follows:
- (1) From -30° to +50° centigrade for all equipment except that specified in paragraphs (a) (2) and (3) of this section.
 - (b) Frequency measurements shall be made at the extremes of the specified temperature range and at intervals of not more than 10° centigrade through the range. A period of time sufficient to stabilize all of the components of the oscillator circuit at each temperature level shall be allowed prior to frequency measurement. The short term transient effects on the frequency of the transmitter due to keying (except for broadcast transmitters) and any heating element cycling normally occurring at each ambient temperature level also shall be shown. Only the portion or portions of the transmitter containing the frequency determining and stabilizing circuitry need be subjected to the temperature variation test.
 - (d) The frequency stability shall be measured with variation of primary supply voltage as follows:
 - (1) Vary primary supply voltage from 85 to 115 percent of the nominal value for other than hand carried battery equipment.
 - (2) For hand carried, battery powered equipment, reduce primary supply voltage to the battery operating end point which shall be specified by the manufacturer.
 - (3) The supply voltage shall be measured at the input to the cable normally provided with the equipment, or at the power supply terminals if cables are not normally provided. Effects on frequency of transmitter keying (except for broadcast transmitters) and any heating element cycling at the nominal supply voltage and at each extreme also shall be shown.

§22.355 Frequency tolerance

...the carrier frequency of each transmitter in the Public Mobile Service must be maintained within the tolerances given in table C-1 of this section.

Table C-1.- Frequency Tolerance for Transmitters in the Public Mobile Services

Frequency range (MHz)	Base, fixed (ppm)	Mobile up to 3 watts (ppm)	Mobile above 3 watts (ppm)
25 to 50	20.0	20.0	50.0
50 to 450	5.0	5.0	50.0
450 to 512	2.5	5.0	5.0
821 to 896	1.5	2.5	2.5
928 to 929	5.0	n/a	n/a
929 to 960	1.5	n/a	n/a
2110 to 2220	10.0	n/a	n/a

For the mid channel (836.6 MHz) the frequency tolerance is 2.5 ppm (2091.5 Hz).

Band edge compliance

The test was performed according to: FCC §22.913

Test Description

- 1) The EUT was coupled to a Spectrum Analyser and a Digital Communication Tester through a Power Divider. Refer to chapter "Setup Drawings".
- 2) The total insertion losses for signal path 1 and signal path 2 were measured. The values were used to correct the readings from the Spectrum Analyser and the Digital Communication Tester.
- 3) A call was established on a Traffic Channel between the EUT and the Digital Communication Tester.

Important Settings:

- Output Power: Maximum
- Channel: please refer to the detailed results

4) Important Analyser Settings:

- Resolution Bandwidth = Video Bandwidth: >1% of the manufacturer's stated occupied bandwidth

Test Requirements / Limits

§ 22.917 Emission limitations for cellular equipment

Refer to chapter "Field strength of spurious radiation".

Subtests HSDPA

Sub-test	β_c	β_d	β_d (SF)	β_c/β_d	β_{HS} (Note1, Note 2)	CM (dB) (Note 3)	MPR (dB) (Note 3)
1	2/15	15/15	64	2/15	4/15	0.0	0.0
2	12/15 (Note 4)	15/15 (Note 4)	64	12/15 (Note 4)	24/15	1.0	0.0
3	15/15	8/15	64	15/8	30/15	1.5	0.5
4	15/15	4/15	64	15/4	30/15	1.5	0.5

Note 1: $?_{ACK}, ?_{NACK}$ and $?_{CQI} = 30/15$ with $\beta_{hs} = 30/15 * \beta_c$.

Note 2: For the HS-DPCCH power mask requirement test in clause 5.2C, 5.7A, and the Error Vector Magnitude (EVM) with HS-DPCCH test in clause 5.13.1A, and HSDPA EVM with phase discontinuity in clause 5.13.1AA, $?_{ACK}$ and $?_{NACK} = 30/15$ with $\beta_{hs} = 30/15 * \beta_c$, and $?_{CQI} = 24/15$ with $\beta_{hs} = 24/15 * \beta_c$.

Note 3: CM = 1 for $\beta_c/\beta_d = 12/15, \beta_{hs}/\beta_c = 24/15$. For all other combinations of DPDCH, DPCCH and HS-DPCCH the MPR is based on the relative CM difference. This is applicable for only UEs that support HSDPA in release 6 and later releases.

Note 4: For subtest 2 the β_c/β_d ratio of 12/15 for the TFC during the measurement period (TF1, TF0) is achieved by setting the signalled gain factors for the reference TFC (TF1, TF1) to $\beta_c = 11/15$ and $\beta_d = 15/15$.

Subtests HSUPA

Subtest	Mode	Loopback Mode	Rel99 RMC	HSDPA FRC	HSUPA Test	Number of E-DPDCH Channels
1	Rel6 HSUPA	Test Mode 1	12.2kbps RMC	H-Set1	HSUPA Loopback	1
2	Rel6 HSUPA	Test Mode 1	12.2kbps RMC	H-Set1	HSUPA Loopback	1
3	Rel6 HSUPA	Test Mode 1	12.2kbps RMC	H-Set1	HSUPA Loopback	2
4	Rel6 HSUPA	Test Mode 1	12.2kbps RMC	H-Set1	HSUPA Loopback	1
5	Rel6 HSUPA	Test Mode 1	12.2kbps RMC	H-Set1	HSUPA Loopback	1

Subtest	Max UL Data Rate (kb/s)	β_c/β_d	β_{hs}	β_{ed}	CM
1	242.1	11/15	22/15	1309/225	1
2	161.3	6/15	12/15	94/75	3
3	524.7	15/9	30/15	47/15	2
4	197.6	2/15	4/15	56/75	3
5	299.6	15/15	30/15	134/15	1

Setup Drawings

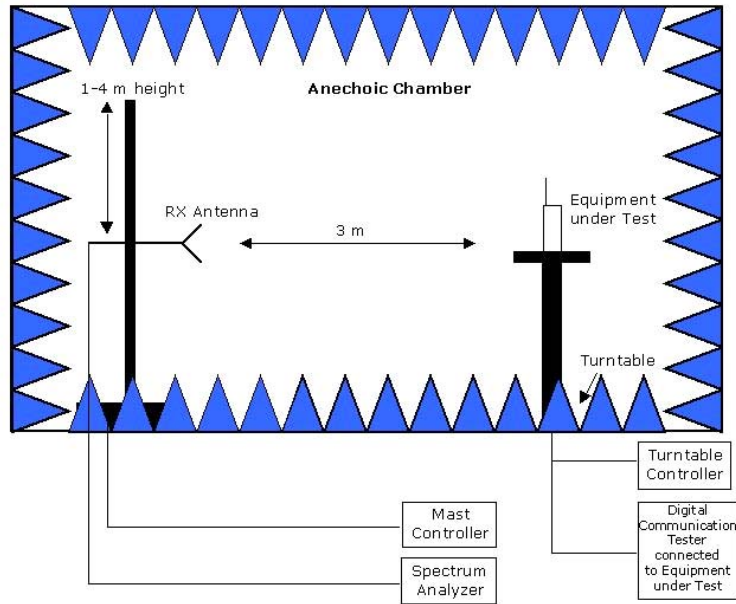

Remark: Depending on the frequency range suitable antenna types, attenuators or preamplifiers are used.

Principle set-up for radiated measurements

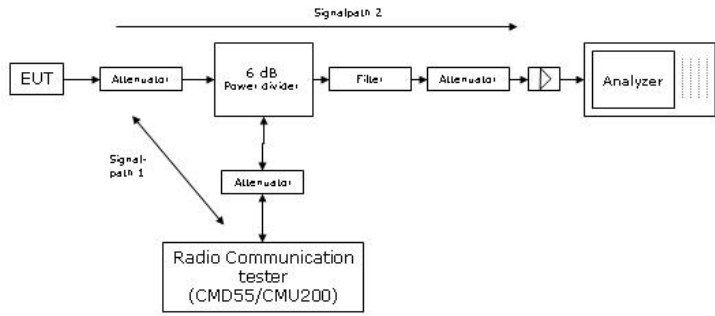

Remark: Depending on the frequency range suitable attenuators and/or filters and/or amplifiers are used.

Principle set-up for conducted measurements under nominal conditions

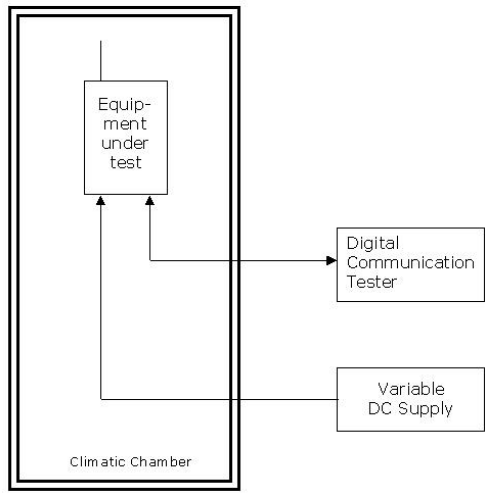

Principle set-up for tests under extreme test conditions



6 Index

1	Administrative Data	2
1.1	Project Data	2
1.2	Applicant Data	2
1.3	Test Laboratory Data	2
1.4	Signature of the Testing Responsible	3
1.5	Signature of the Accreditation Responsible	3
2	Test Object Data	4
2.1	General OUT Description	4
2.2	Detailed Description of OUT Samples	5
2.3	OUT Features	6
2.4	Auxiliary Equipment	6
2.5	Setups used for Testing	7
3	Results	7
3.1	General	7
3.2	List of the Applicable Body	7
3.3	List of Test Specification	8
3.4	Summary	9
3.5	Detailed Results	12
3.5.1	22.1 RF Power Output §2.1046, §22.913	12
3.5.2	22.2 Frequency stability §2.1055	31
3.5.3	22.3 Spurious emissions at antenna terminals §2.1051, §22.917	33
3.5.4	22.4 Field strength of spurious radiation §2.1053, §22.917	40
3.5.5	22.5 Emission and Occupied Bandwidth §2.1049, §22.917	46
3.5.6	22.6 Band edge compliance §2.1053, §22.917	65
4	Test Equipment Details	74
4.1	List of Used Test Equipment	74
4.2	Laboratory Environmental Conditions	80
5	Annex	81



5.1 Additional Information for Report

6 Index

92
