



Product Service

---

**Choose certainty.  
Add value.**

# Report On

FCC DFS Testing of the u-blox WiBear11n / ELLA-W1  
In accordance with FCC 47 CFR Part 15E  
and Industry Canada RSS-247

COMMERCIAL-IN-CONFIDENCE

FCC ID: PV7-WIBEAR11N-DF1, PV7-WIBEAR11N-DF2, XPYELLAW161,  
XPYELLAW163  
IC: 7738A-WB11NDF1, 7738A-WB11NDF2, 8595A-ELLAW161, 8595A-  
ELLAW163

Document 75931212 Report 01 Issue 2

September 2015



Product Service

TÜV SÜD Product Service, Octagon House, Concorde Way, Segensworth North,  
Fareham, Hampshire, United Kingdom, PO15 5RL  
Tel: +44 (0) 1489 558100. Website: [www.tuv-sud.co.uk](http://www.tuv-sud.co.uk)

COMMERCIAL-IN-CONFIDENCE

**REPORT ON**

FCC DFS Testing of the  
u-blox WiBear11n / ELLA-W1  
In accordance with FCC 47 CFR Part 15E  
and Industry Canada RSS-247

Document 75931212 Report 01 Issue 2

September 2015

**PREPARED FOR**

u-blox AG  
Zürcherstrasse 68  
CH-8800 Thalwil  
Switzerland

**PREPARED BY**

**Natalie Bennett**  
Senior Administrator, Project Support

**APPROVED BY**

**Stephen Milliken**  
Authorised Signatory

**DATED**

03 September 2015

**This report has been up-issued to Issue 2 to correct the model name on pages, 4, 14 and 21.**

---

ENGINEERING STATEMENT

The measurements shown in this report were made in accordance with the procedures described on test pages. All reported testing was carried out on a sample equipment to demonstrate limited compliance with FCC 47 CFR Part 15E and Industry Canada RSS-247. The sample tested was found to comply with the requirements defined in the applied rules.

Test Engineer(s);

S Bennett





## CONTENTS

Section	Page No
<b>1</b>	<b>REPORT SUMMARY ..... 3</b>
1.1	Introduction ..... 4
1.2	Test Requirements ..... 5
1.3	Brief Summary of Results ..... 6
1.4	Application Form ..... 7
1.5	Product Information ..... 10
1.6	Test Conditions ..... 10
1.7	Deviations from the Standard ..... 10
1.8	Modification Record ..... 10
1.9	DFS Test System ..... 11
<b>2</b>	<b>TEST DETAILS ..... 13</b>
2.1	Calibration of Test Setup ..... 14
2.2	In-Service Monitoring ..... 21
<b>3</b>	<b>TEST EQUIPMENT USED ..... 28</b>
3.1	Test Equipment Used ..... 29
3.2	Support Test Equipment ..... 30
3.3	Measurement Uncertainty ..... 31
<b>4</b>	<b>PHOTOGRAPHS ..... 32</b>
4.1	Test Set-Up Photographs ..... 33
4.2	DFS Test Equipment ..... 33
<b>5</b>	<b>ACCREDITATION, DISCLAIMERS AND COPYRIGHT ..... 34</b>
5.1	Accreditation, Disclaimers and Copyright ..... 35



Product Service

## **SECTION 1**

### **REPORT SUMMARY**

FCC DFS Testing of the  
u-blox WiBear11n / ELLA-W1  
In accordance with FCC 47 CFR Part 15E and Industry Canada RSS-247



Product Service

## 1.1 INTRODUCTION

The information contained in this report is intended to show the verification of FCC DFS Testing of the u-blox WiBear11n / ELLA-W1 to the requirements of FCC 47 CFR Part 15E and Industry Canada RSS-247.

Objective	To perform DFS Testing to determine the Equipment Under Test's (EUT's) compliance with the Test Specification, for the series of tests carried out.
Manufacturer	u-blox
Model Number(s)	WiBear11n / ELLA-W1
Serial Number(s)	409183
Hardware Version	WiBear11n: E6, ELLA-W1: G8
Software Version	14.44.35
Number of Samples Tested	1
Test Specification/Issue/Date	FCC 47 CFR Part 15E (2014) Industry Canada RSS-247 (Issue 1, May 2015)
Incoming Release Date	Application Form 16 July 2015
Disposal Reference Number Date	Held Pending Disposal Not Applicable Not Applicable
Order Number Date	LALB-201507081_Rev0 8 July 2015
Start of Test	10 July 2015
Finish of Test	16 July 2015
Name of Engineer(s)	S Bennett
Related Document(s)	KDB 905462 D02 v01r02 KDB 905462 D06 v01r02 KDB 905462 D04 v01 KDB 662911 D01 UKAS M3003: Edition 2 (2007) ETSI TR 100 028 (2001)



1.2 TEST REQUIREMENTS

Table 1: Applicability of DFS Requirements Prior to Use of a Channel

Requirement	Operational Mode		
	Master	Client Without Radar Detection	Client With Radar Detection
Non-Occupancy Period	Yes	Not required	Yes
DFS Detection Threshold	Yes	Not required	Yes
Channel Availability Check Time	Yes	Not required	Not required
U-NII Detection Bandwidth	Yes	Not required	Yes

Table 2: Applicability of DFS requirements during normal operation

Requirement	Operational Mode	
	Master Device or Client With Radar Detection	Client Without Radar Detection
DFS Detection Threshold	Yes	Not required
Channel Closing Transmission Time	Yes	Yes
Channel Move Time	Yes	Yes
U-NII Detection Bandwidth	Yes	Not required

Additional requirements for devices with multiple bandwidths modes	Master Device or Client with Radar Detection	Client Without Client Without Radar Detection
U-NII Detection Bandwidth and Statistical Performance Check	All BW modes must be tested	Not required
Channel Move Time and Channel Closing Transmission Time	Test using widest BW mode available	Test using the widest BW mode available for the link
All other tests	Any single BW mode	Not required
<p><b>Note:</b> Frequencies selected for statistical performance check (Section 7.8.4) should include several frequencies within the radar detection bandwidth and frequencies near the edge of the radar detection bandwidth. For 802.11 devices it is suggested to select frequencies in each of the bonded 20 MHz channels and the channel center frequency.</p>		



Product Service

**1.3 BRIEF SUMMARY OF RESULTS**

A brief summary of the tests carried out in accordance with FCC 47 CFR Part 15E and Industry Canada RSS-247 is shown below.

Section	Specification Clause		Test Description	Result	Comments/Base Standard
	Part 15	RSS-247			
802.11a					
2.1	-	-	Calibration of Test Setup	Pass	
2.2	15.407 (h)(2)(iii)(iv)	6.3 (2)(i)(iii)(iv)	In-Service Monitoring	Pass	
802.11n - 40 MHz Bandwidth					
2.1	-	-	Calibration of Test Setup	Pass	
2.2	15.407 (h)(2)(iii)(iv)	6.3 (2)(i)(iii)(iv)	In-Service Monitoring	Pass	



1.4 APPLICATION FORM

EQUIPMENT DESCRIPTION	
Model Name/Number	WiBear11n-DF1/-DF2, ELLA-W161/-W163
Part Number	AN00J93172/AN00J94360, AN00J94362/AN00J93176, ELLA-W161-00B-00, ELLA-W163-00B-00, ELLA-W161-00A-00, ELLA-W163-00A-00
Hardware Version	WiBear11n: E6, ELLA-W1: G8
Software Version	14.44.35
FCC ID	PV7-WIBEAR11N-DF1, PV7-WIBEAR11N-DF2, XPYELLOW161, XPYELLOW163
IC	7738A-WB11NDF1, 7738A-WB11NDF2, 8595A-ELLAW161, 8595A-ELLAW163
Technical Description (Please provide a brief description of the intended use of the equipment)	Short-range radio module supporting IEEE 802.11a/b/g/n Wi-Fi, Bluetooth 3.0+HS

TYPE OF EQUIPMENT	
<input checked="" type="checkbox"/>	Master
<input type="checkbox"/>	Client with Radar Detection
<input checked="" type="checkbox"/>	Client without Radar Detection
<input checked="" type="checkbox"/>	Wi-Fi Direct Support

TRANSMITTER TECHNICAL CHARACTERISTICS	
FREQUENCY CHARACTERISTICS	
<input checked="" type="checkbox"/>	5.150 GHz to 5.250 GHz
<input checked="" type="checkbox"/>	5.250 GHz to 5.350 GHz
<input checked="" type="checkbox"/>	5.470 GHz to 5.725 GHz
<input checked="" type="checkbox"/>	5.725 GHz to 5.825 GHz
<input checked="" type="checkbox"/>	Please confirm the EUT does not operate in the frequency band 5600 – 5650 MHz
<input type="checkbox"/>	Off Channel CAC Implemented
	Off Channel CAC within 5600 – 5650 MHz band                      hours, (1 – 24)
	Off Channel CAC outside 5600 – 5650 MHz band                    minutes, (6 – 240)
Note: DFS is not required in the ranges 5.15 – 5.25 GHz and 5.725 – 5.825 GHz	

TRANSMITTER RF POWER CHARACTERISTICS	
Maximum rated transmitter output power as stated by manufacturer	
Conducted Power	15 dBm
Maximum Antenna Gain	4.6 dBi
EIRP	19.6 dBm
Minimum rated transmitter output power as stated by manufacturer (if applicable)	
Conducted Power	6 dBm
Maximum Antenna Gain	4.6 dBi
EIRP	10.6 dBm
Is TPC supported?	<input checked="" type="checkbox"/> Yes <input type="checkbox"/> No
If Yes, provide a description of operation.	
Power depends on modulation scheme and distance to access point or client.	





Product Service

POWER SOURCE	
<input type="checkbox"/> AC mains supply	State voltage
AC supply frequency (Hz)	VAC
<input checked="" type="checkbox"/> DC supply	
Nominal voltage	3.3

SYSTEM ARCHITECTURE			
<input type="checkbox"/>	Frame Based		
<input checked="" type="checkbox"/>	IP Based		
<input type="checkbox"/>	Other	If other please state	
<input checked="" type="checkbox"/>	802.11(a)	Receiver Bandwidth:	20 MHz
<input checked="" type="checkbox"/>	802.11(n) – 20 MHz	Receiver Bandwidth:	20 MHz
<input checked="" type="checkbox"/>	802.11(n) – 40 MHz	Receiver Bandwidth:	40 MHz
<input type="checkbox"/>	802.11(ac) – 20 MHz	Receiver Bandwidth:	MHz
<input type="checkbox"/>	802.11(ac) – 40 MHz	Receiver Bandwidth:	MHz
<input type="checkbox"/>	802.11(ac) – 80 MHz	Receiver Bandwidth:	MHz

DECLARATION	
No parameter or information relating to the detected radar waveforms is available or accessible to the end user.	
<input checked="" type="checkbox"/> True	<input type="checkbox"/> False

MISCELLANEOUS (Master Device Only)	
Power-on cycle time*	0 s
* Time from switching on the UUT to the point at which Channel Availability Check (CAC) commences	

UNIFORM SPREADING (Master Device Only)	
Describe how the meter provides, on aggregate, uniform channel loading of the spectrum across all channels.	
Channels are randomly selected by the access point.	



Product Service

ANTENNA OPTIONS	
<b>Antenna 1</b>	
Antenna Description:	.On board SMT antenna
Antenna Model:	Antenova A10194
Antenna Maximum Gain:	4.1 dB
Antenna Frequency Range:	4.900 - 5.900 GHz
<b>Antenna 2</b>	
Antenna Description:	Dipole antenna
Antenna Model:	Linx ANT-DB1-RAF-RPS
Antenna Maximum Gain:	4.6 dB
Antenna Frequency Range:	5.150 - 5.850 GHz
<b>Antenna 3</b>	
Antenna Description:	Dipole antenna
Antenna Model:	Taoglas GW.40.2153
Antenna Maximum Gain:	2.5 dB
Antenna Frequency Range:	5.150 - 5.850 GHz
<b>Antenna 4</b>	
Antenna Description:	Dipole antenna
Antenna Model:	Taoglas GW.59.3153
Antenna Maximum Gain:	2.93 dB
Antenna Frequency Range:	5.150 - 5.850 GHz
<b>Antenna 5</b>	
Antenna Description:	
Antenna Model:	
Antenna Maximum Gain:	
Antenna Frequency Range:	

I hereby declare that I am entitled to sign on behalf of the applicant and that the information supplied is correct and complete.

Signature: *Maly* Name: *Matthias Mahlig*  
 Position held: *Manager HW-Engineering* Date: *2015-07-16*



Product Service

## 1.5 PRODUCT INFORMATION

### 1.5.1 Technical Description

The Equipment Under Test (EUT) was a u-blox WiBear11n / ELLA-W1. A full technical description can be found in the manufacturer's documentation.

The EUT is a Client without Radar Detection device.

The following is provided by the applicant as part of the FCC filing:

- A complete User's Manual and/or Professional Installers Manual.
- A Statement of Conformity for the Client in Non-Associated mode is required. The Form 731 application must include a Cover Letter Attachment stating that the client software and associated drivers will not initiate any transmission on DFS frequencies without initiation by a master. This includes restriction on transmissions for beacons and support for ad-hoc peer-to-peer modes.
- A channel/frequency plan for the device showing the channels that have active scanning or passive scanning. Active scanning is where the device can transmit a probe (beacon) and passive scanning is where the device can listen only without probes.
- Software security description.

## 1.6 TEST CONDITIONS

For all tests the EUT was set up in accordance with the relevant test standard and to represent typical operating conditions. See individual test clauses.

The development board was powered from a 10.0 V DC supply, which in turn provided 3.3 V DC to the EUT.

FCC Measurement Facility Registration Number  
90987 Octagon House, Fareham Test Laboratory

## 1.7 DEVIATIONS FROM THE STANDARD

No deviations from the applicable test standard were made during testing.

## 1.8 MODIFICATION RECORD

Modification 0 - No modifications were made to the test sample during testing.



**1.9 DFS TEST SYSTEM**

The DFS system consists of hardware and software. The Hardware uses a PXI chassis with PXI instruments populating the chassis. The instruments used are a Vector Signal Generator, a Digitiser, Frequency References and a Dual Core PC. The measurement and analysis software runs on the PC and controls the instruments within the mainframe via commands on the PXI bus. Various markers are contained within the generated waveforms. The markers are used to trigger the measurement system at the appropriate points. An external trigger is also provided at the SMB output on the Vector Signal Generator which is employed where a Spectrum Analyser is used in place of the Aeroflex Digitiser. These are described within the test procedure for the applicable test.

The Aeroflex DFS software generates the pulses in accordance with KDB 905462 D02 UNII DFS Compliance Procedures New Rules v01r02.

Short Pulse Radar Test Waveform

The short pulse radar simulation is a conventional amplitude pulse with varying pulse widths, pulse rate intervals (PRI) and number of pulses. General characteristics for these types and number of repetitions required by the standard are as follows:

Radar Type	Pulse Width (µsec)	PRI (µsec)	Number of Pulses	Minimum Percentage of Successful Detection	Minimum Number of Trials
0	1	1428	18	See Note 1	See Note 1
1	1	Test A: 15 unique PRI values randomly selected from the list of 23 PRI values in Table 5a	Roundup $\left\{ \left( \frac{1}{360} \right) \right\}$ $\frac{19 - 10^6}{PRI_{\mu sec}}$	60%	30
		Test A: 15 unique PRI values randomly selected from the list of 23 PRI values in Table 5a	-		
2	1-5	150-230	23-29	60%	30
3	6-10	200-500	16-18	60%	30
4	11-20	200-500	12-16	60%	30
Aggregate (Radar Types 1-4)				80%	120
<b>Note 1:</b> Short Pulse Radar Type 0 should be used for the detection bandwidth test, channel move time, and channel closing time tests.					

Long Pulse Radar Test Waveform

Radar Type	Pulse Width (µsec)	Chirp Width (MHz)	PRI (µsec)	Number of Pulses per burst	Number of Bursts	Minimum Percentage of Successful Detection	Minimum Number of Trials
5	50-100	5-20	1000-2000	1-3	8-20	80%	30



Product Service

Frequency Hopping Radar Test Waveform

Radar Type	Pulse Width (µsec)	PRI (µsec)	Pulses per Hop	Hopping Rate (kHz)	Hopping Sequence Length (msec)	Minimum Percentage of Successful Detection	Minimum Number of Trials
6	1	333	9	0.333	300	70%	30



Product Service

## **SECTION 2**

### **TEST DETAILS**

FCC DFS Testing of the  
u-blox WiBear11n / ELLA-W1  
In accordance with FCC 47 CFR Part 15E



Product Service

**2.1 CALIBRATION OF TEST SETUP**

**2.1.1 Specification Reference**

FCC 47 CFR Part 15E, FCC KDB 905462 D02 v01r02

**2.1.2 Equipment Under Test and Modification State**

WiBear11n / ELLA-W1 S/N: 409183 - Modification State 0

**2.1.3 Date of Test**

9 July 2015, 10 July 2015

**2.1.4 Environmental Conditions**

Ambient Temperature	23.7°C
Relative Humidity	48.7 - 48.9%



**2.1.5 Test Results**

802.11a

In this test equipment configuration, Radar signals are injected at the Master. The configuration ensures that the Radar pulses are received only by the Master device and not the Client. To calibrate the Radar pulses, the master was replaced by a Spectrum Analyser. The required Radar Waveform, (Type 0), was loaded into the Arbitrary Waveform Generator. The Spectrum Analyser was set to zero Span and the RBW and VBW set to 3MHz. The sweep time was set to display the entire burst and triggered on the Radar Burst. The output level of the Radar Signal Generator was adjusted to give the correct level as defined in the table below with the 1dB correction accounted for. Trace data showing the used Radar Pulses was recorded.

DFS Detection Thresholds for Master Devices and Client Devices With Radar Detection

Maximum Transmit Power	Value (Notes 1 and 2)
≥ 200 milliwatt	-64 dBm
< 200 milliwatt	-62 dBm

Note 1: This is the level at the input of the receiver assuming a 0 dBi receive antenna.  
 Note 2: Throughout these test procedures an additional 1 dB has been added to the amplitude of the test transmission waveforms to account for variations in measurement equipment. This will ensure that the test signal is at or above the detection threshold level to trigger a DFS response.

Test Equipment Setup

**Setup for Client with injection at the Master**

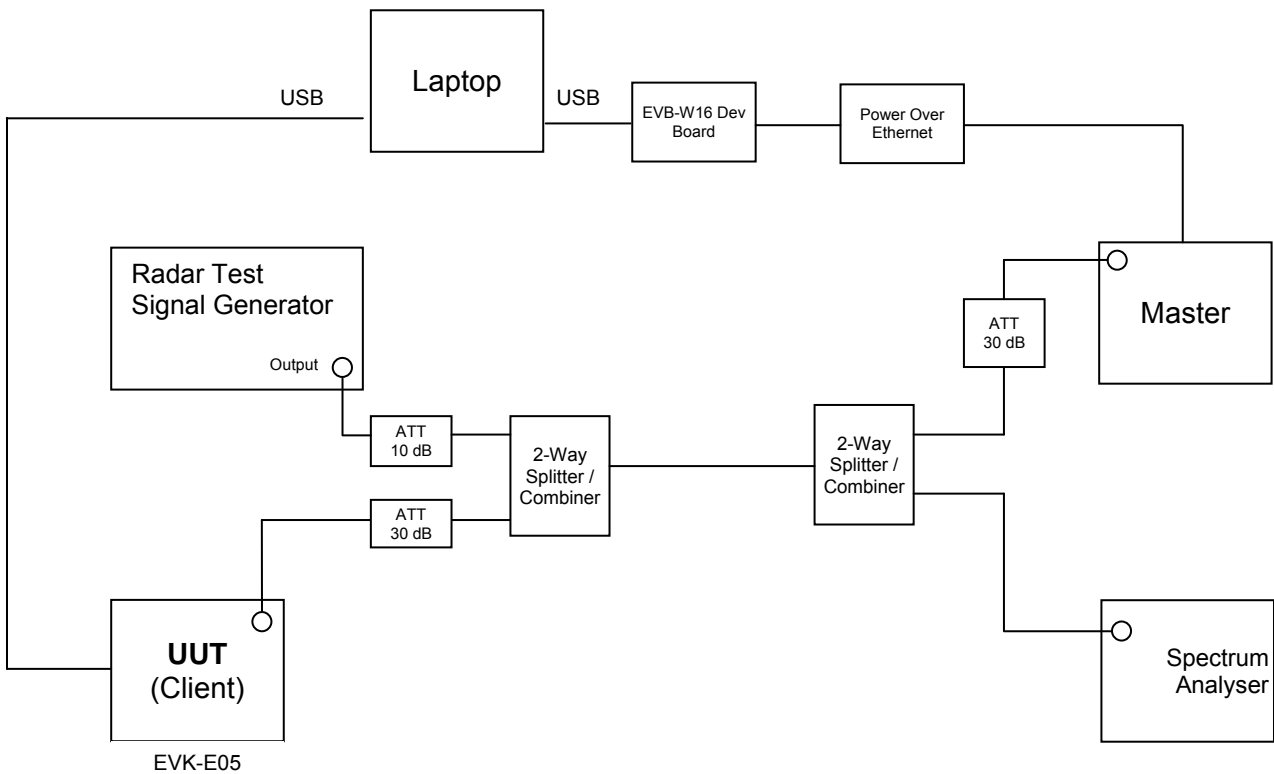





Product Service

Radar Pulse Type 0

Short Radar Pulse Characteristics

Radar Type	Pulse Width (µs)	PRI (µs)	Number of Pulses
0	1	1428	18

Client without Radar Detection

Radar Type 0 Plot

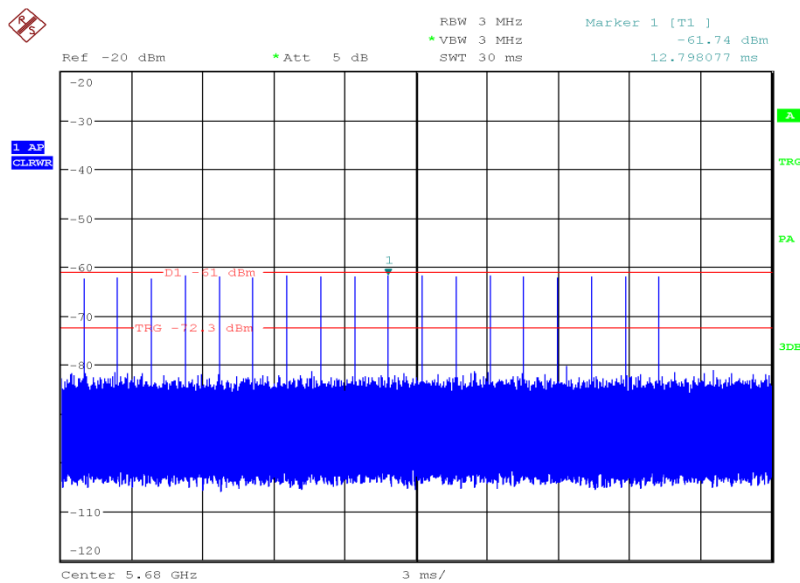

Date: 10.JUL.2015 10:00:12



Product Service

Channel Loading Plot

Channel Loading: 27.24 %

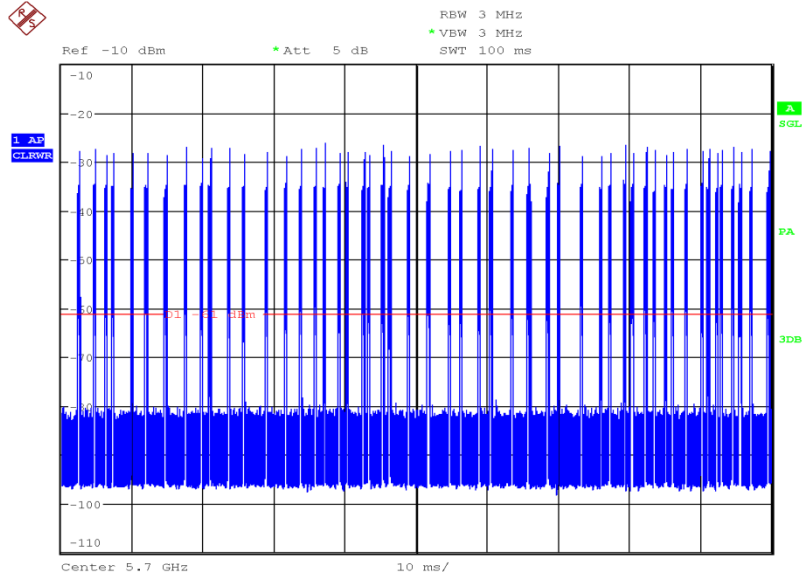

Date: 9.JUL.2015 18:55:26

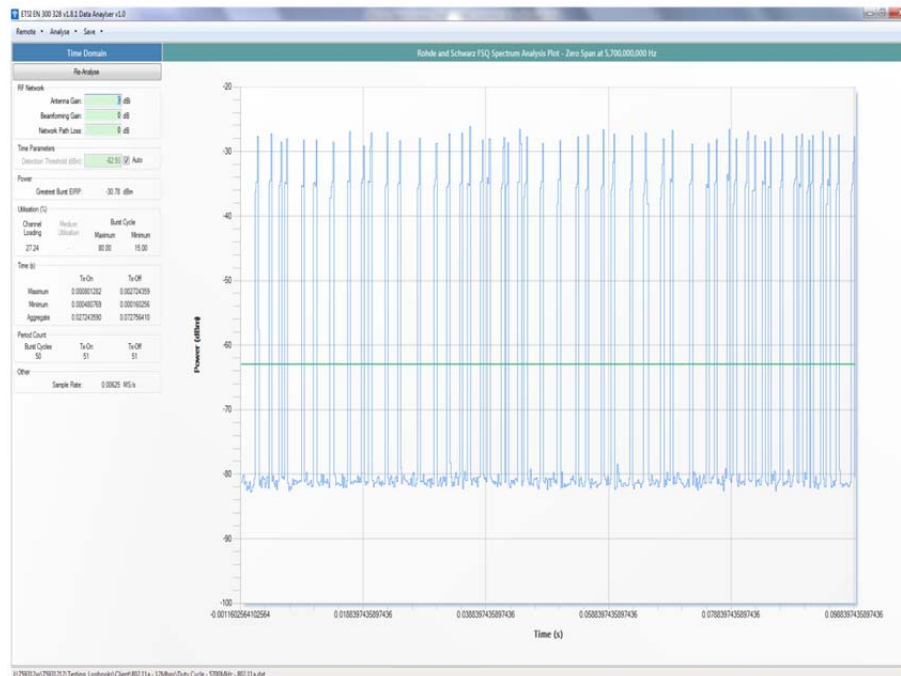



802.11n - 40 MHz Bandwidth

In this test equipment configuration, Radar signals are injected at the Master. The configuration ensures that the Radar pulses are received only by the Master device and not the Client. To calibrate the Radar pulses, the master was replaced by a Spectrum Analyser. The required Radar Waveform, (Type 0), was loaded into the Arbitrary Waveform Generator. The Spectrum Analyser was set to zero Span and the RBW and VBW set to 3MHz. The sweep time was set to display the entire burst and triggered on the Radar Burst. The output level of the Radar Signal Generator was adjusted to give the correct level as defined in the table below with the 1dB correction accounted for. Trace data showing the used Radar Pulses was recorded.

DFS Detection Thresholds for Master Devices and Client Devices With Radar Detection

Maximum Transmit Power	Value (Notes 1 and 2)
≥ 200 milliwatt	-64 dBm
< 200 milliwatt	-62 dBm

Note 1: This is the level at the input of the receiver assuming a 0 dBi receive antenna.  
 Note 2: Throughout these test procedures an additional 1 dB has been added to the amplitude of the test transmission waveforms to account for variations in measurement equipment. This will ensure that the test signal is at or above the detection threshold level to trigger a DFS response.

Test Equipment Setup

**Setup for Client with injection at the Master**

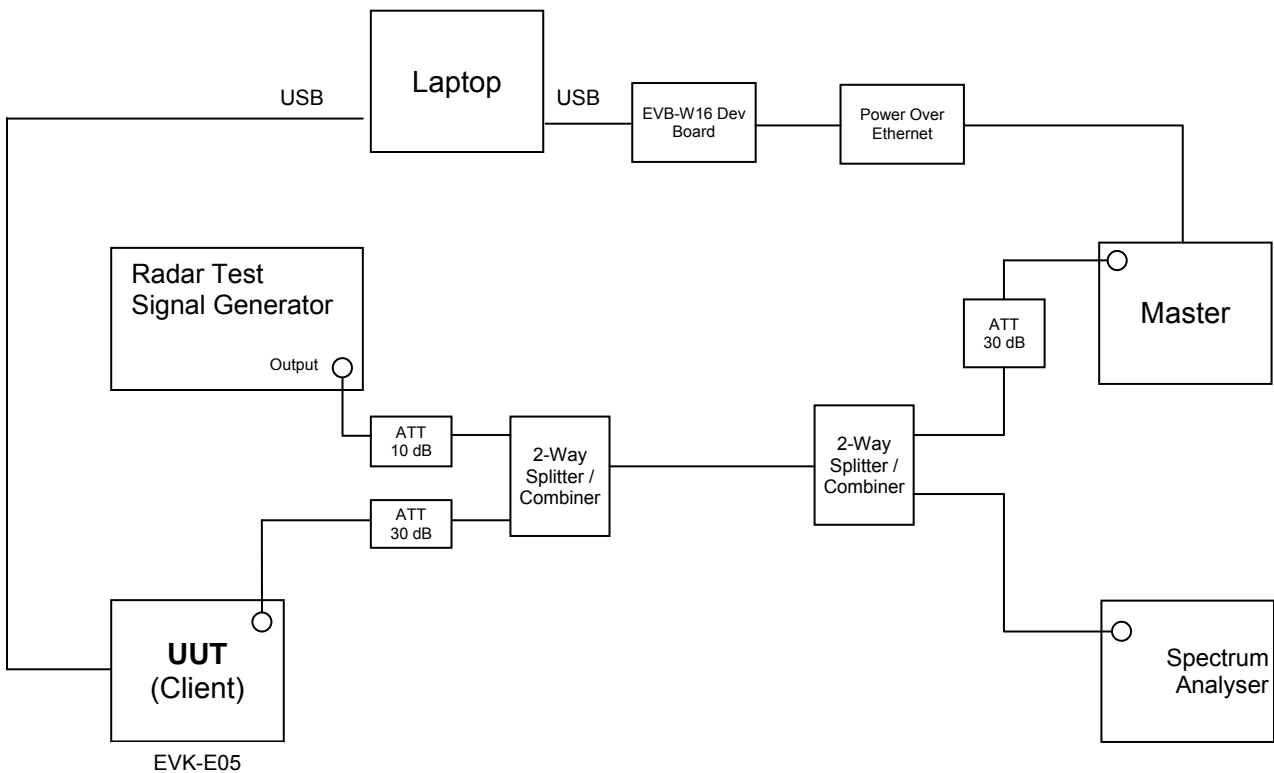

Note: For 802.11n – 40 MHz testing, 2 ports of the DFS Master were combined.



Product Service

Radar Pulse Type 0

Short Radar Pulse Characteristics

Radar Type	Pulse Width (µs)	PRI (µs)	Number of Pulses
0	1	1428	18

Client without Radar Detection

Radar Type 0 Plot

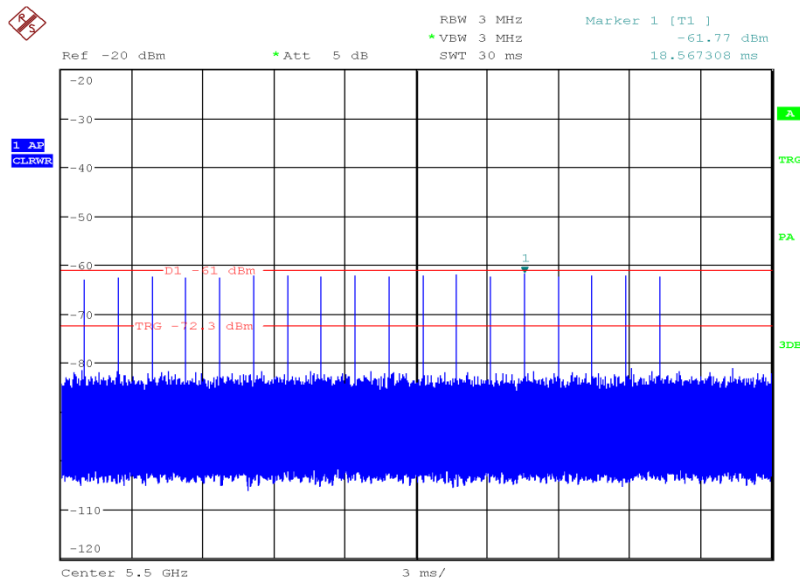

Date: 10.JUL.2015 09:56:14



Product Service

Channel Loading Plot

Channel Loading: 32.69 %

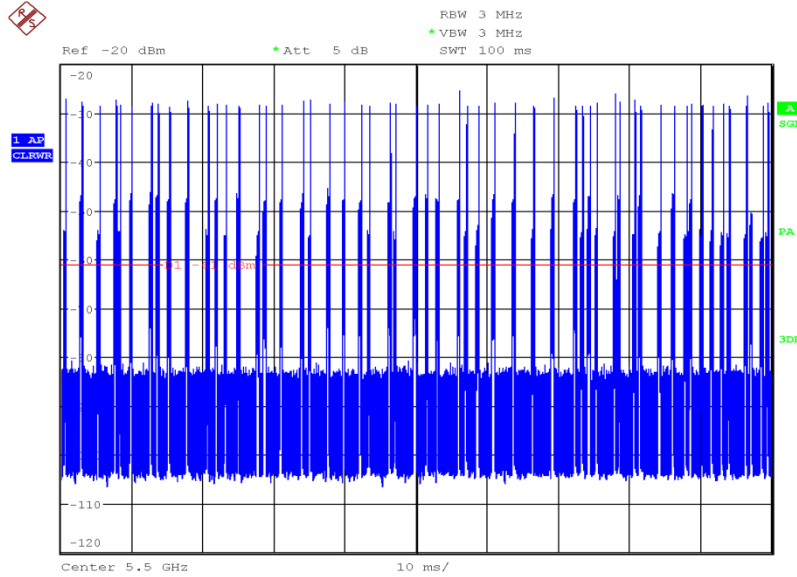

Date: 10.JUL.2015 09:18:47

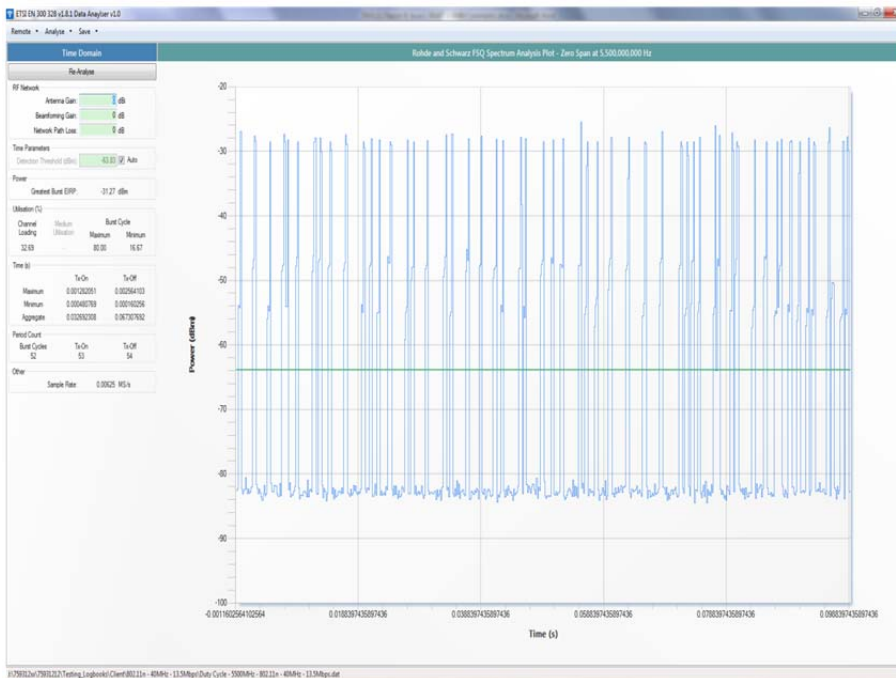



## 2.2 IN-SERVICE MONITORING

### 2.2.1 Specification Reference

FCC 47 CFR Part 15E, Clause 15.407 (h)(2)(iii)(iv)  
 Industry Canada RSS-247, Clause 6.3 (2)(i)(iii)(iv)

### 2.2.2 Equipment Under Test and Modification State

WiBear11n / ELLA-W1 S/N: 409183 - Modification State 0

### 2.2.3 Date of Test

10 July 2015 & 15 July 2015

### 2.2.4 Test Equipment Used

The major items of test equipment used for the above tests are identified in Section 3.1.

### 2.2.5 Test Procedure

#### Client Without DFS

Testing was carried out in accordance with KDB 905462 D02 v01r02 Clause 7.8.3.

Initially, the UUT was removed from the test setup and replaced with a Spectrum Analyser. A Type 0 Radar burst was sent from the signal generator and its level adjusted until the required level of -61dBm was achieved. The Spectrum Analyser was then replaced with the UUT.

The EUT was associated with the FCC Approved Master device FCC ID: LDK105061 and LDK102062 and IC: 2461B-102061 and 2461B-102062. A laptop was connected via a USB cable to the Master device and initial testing was carried out to determine which data rates/modulation schemes produced a duty cycle of >17 %. The EUT was then configured to send equal length packets with a random ping interval as defined in Clause 7.7(b). A Unicast, (UDP), protocol was used as described in Clause 7.7(d).

The UUT was configured to transfer data between the Master and Client, (as described above). Using the Aeroflex DFS Software, the Radar burst was injected to the Master. The test software triggered the capture mechanism of the PXI Digitiser and data was collected of the Radar burst, the Master and Client devices. The data was analysed with the Channel Move time being measured at the final point where transmissions ceased. It was checked that all transmissions stopped within the 10 second period defined from the point of the end of the final Radar pulse + 10 seconds. In addition, the aggregate on time during the first 200ms and the following 9.8 seconds of the Channel Move Time was computed by the Aeroflex DFS Software.

In addition, the Non-Occupancy period was tested, where it was ensured that no transmissions were measured following the conclusion of the injected Radar pulses. The limit lines on the plot show 10 seconds after the end of the Radar burst and a time period of 30 minutes later, (1810 seconds).

The markers on the trace data correspond to the following time periods:

Red - End Of Radar Burst, (T1)



Product Service

Purple- End Of 200ms Period, (T1 + 200 ms)

Yellow- End Of Channel Move Time, (T1 + 10 seconds)

**2.2.6 Environmental Conditions**

Ambient Temperature 23.6 - 23.7°C  
 Relative Humidity 48.7 - 48.9%

**2.2.7 Test Results**

802.11a, In-Service Monitoring Results – 5520 MHz

Channel Move Time	0.044 seconds
Channel Closing Time (Aggregate Time During 200ms)	0.258 ms
Channel Closing Time (Aggregate Time During +200ms to 10s)	0.000 ms
Channel Closing Time (Aggregate Time During 10s)	0.258 ms

Overall Power vs Time Display, showing channel closing and move time

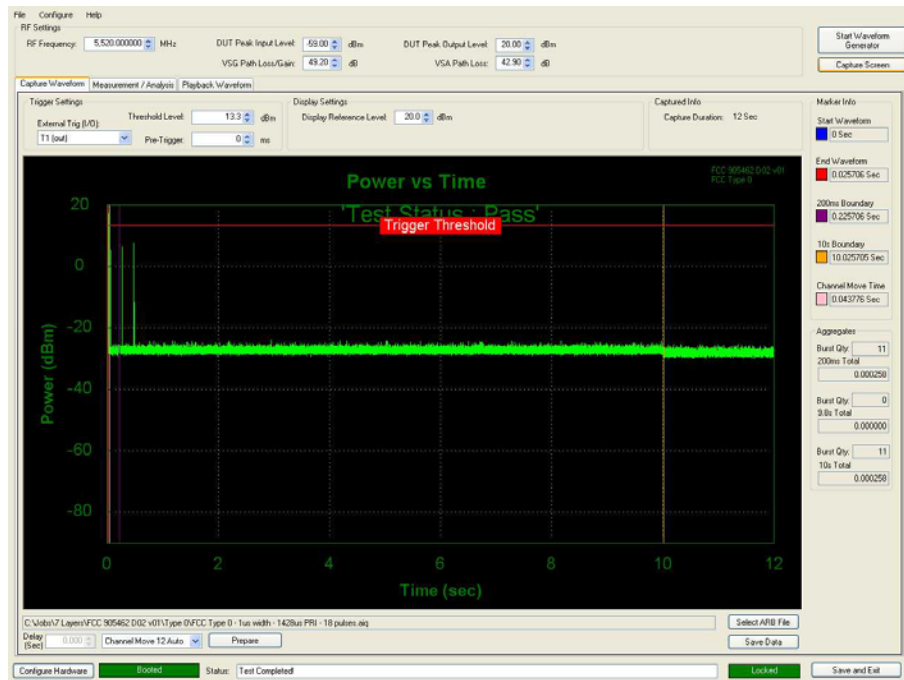



Product Service

### Zoom of Radar Burst, Access Point and Client Signalling

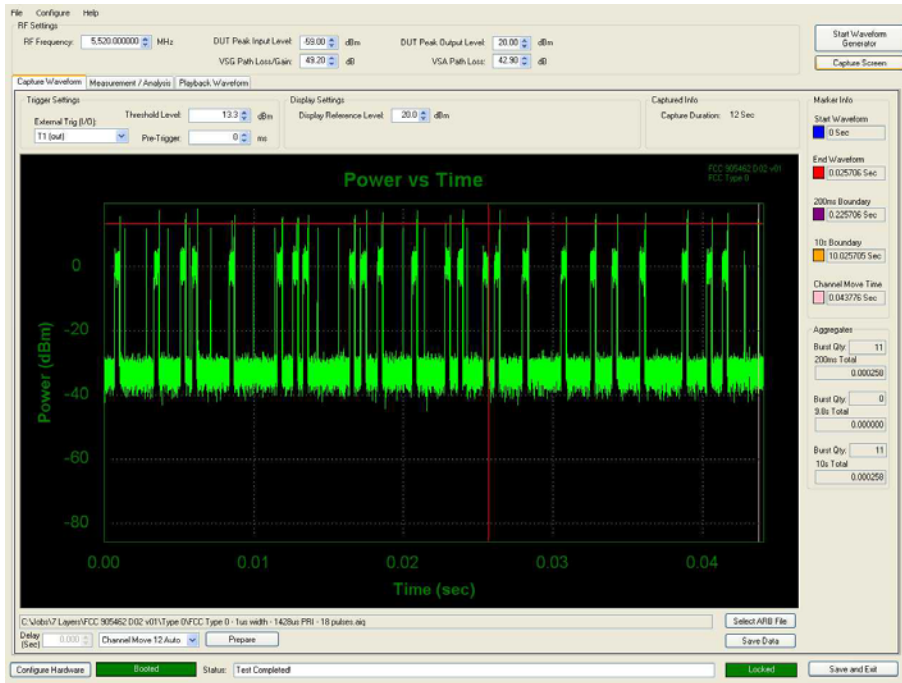

### Non-occupancy Period

The EUT did not resume transmissions during the non-occupancy period.

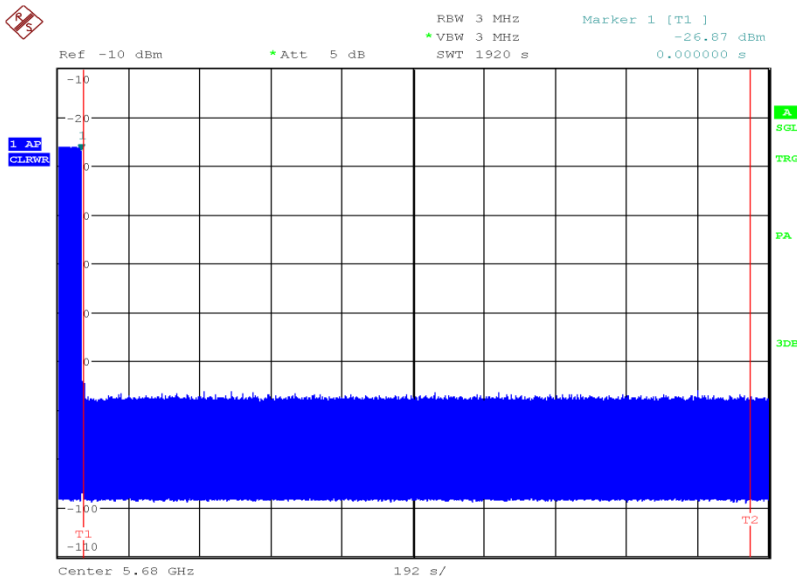





Product Service

FCC 47 CFR Part 15, Limit Clause 15.407 (h)(2)(iii)

Channel Move Time	<10 seconds
Channel Closing Time (Aggregate Time During 200ms)	<200 ms
Channel Closing Time (Aggregate Time During +200ms to 10s)	<60 ms

FCC 47 CFR Part 15, Limit Clause 15.407 (h)(2)(iv)

Non-occupancy Period	> 30 minutes
----------------------	--------------



802.11n - 40 MHz Bandwidth, In-Service Monitoring Results – 5670 MHz

Channel Move Time	4.45 seconds
Channel Closing Time (Aggregate Time During 200ms)	0.616 ms
Channel Closing Time (Aggregate Time During +200ms to 10s)	0.540 ms
Channel Closing Time (Aggregate Time During 10s)	1.156 ms

Overall Power vs Time Display, showing channel closing and move time

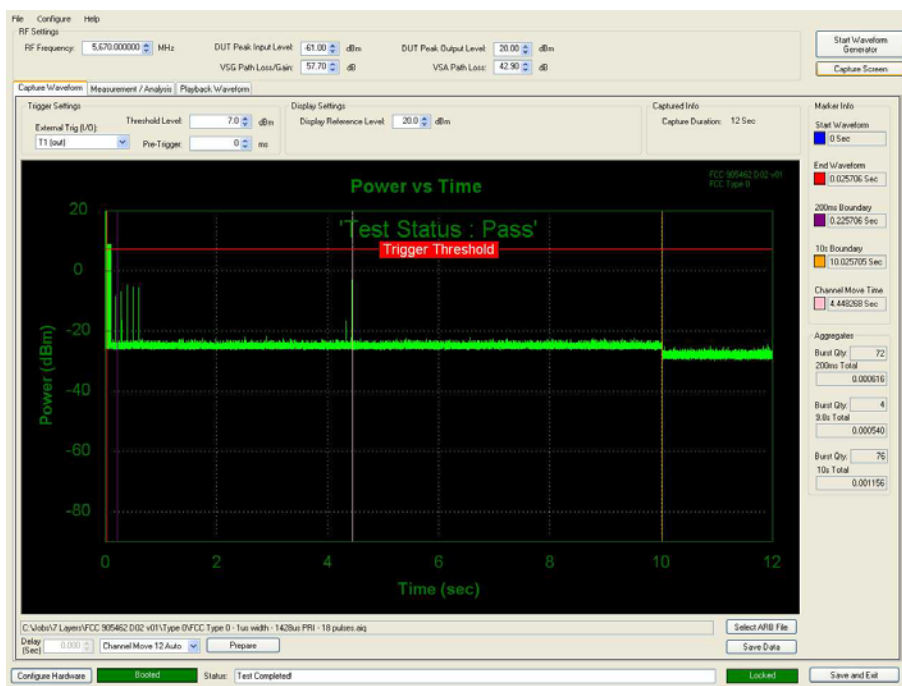



Product Service

### Zoom of Radar Burst, Access Point and Client Signalling

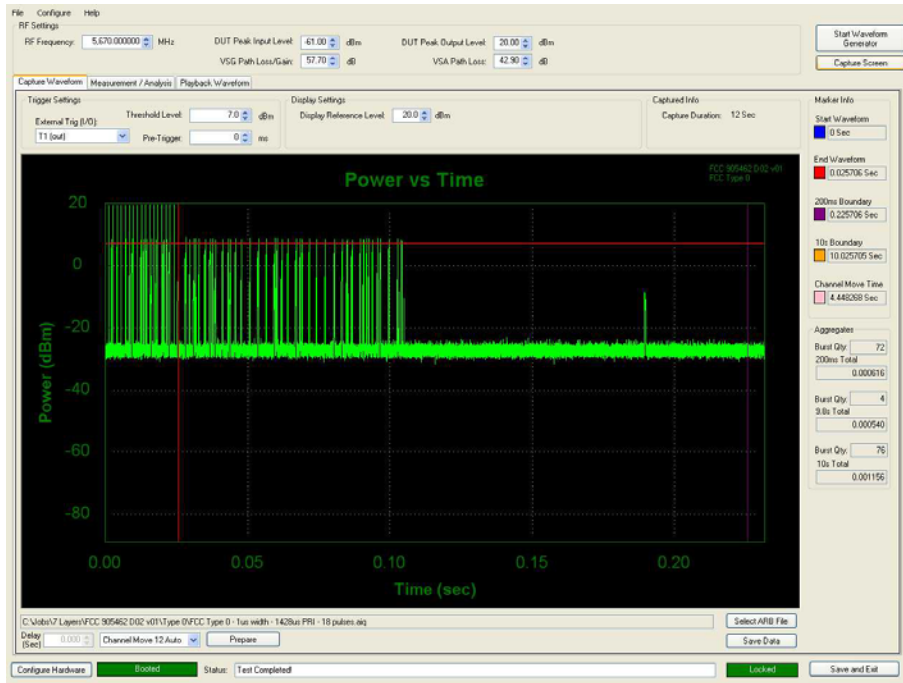

### Non-occupancy Period

The EUT did not resume transmissions during the non-occupancy period.

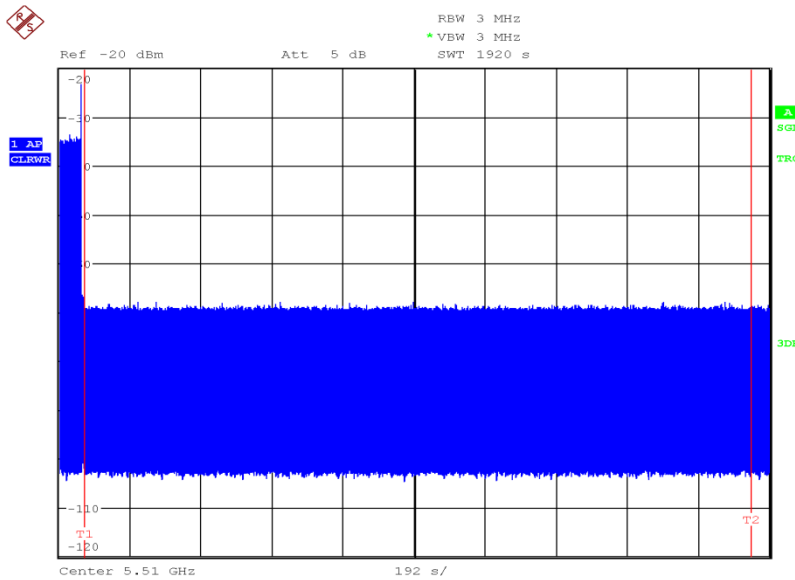

Date: 10.JUL.2015 11:15:04



Product Service

FCC 47 CFR Part 15, Limit Clause 15.407 (h)(2)(iii)

Channel Move Time	<10 seconds
Channel Closing Time (Aggregate Time During 200ms)	<200 ms
Channel Closing Time (Aggregate Time During +200ms to 10s)	<60 ms

FCC 47 CFR Part 15, Limit Clause 15.407 (h)(2)(iv)

Non-occupancy Period	> 30 minutes
----------------------	--------------



Product Service

### **SECTION 3**

#### **TEST EQUIPMENT USED**



Product Service

### 3.1 TEST EQUIPMENT USED

List of absolute measuring and other principal items of test equipment.

Instrument	Manufacturer	Type No.	TE No.	Calibration Period (months)	Calibration Due
<b>Section 2.1 - In-Service Monitoring</b>					
30dB/2W Attenuator	Narda	4772-30	460	-	TU
Multimeter	Iso-tech	IDM101	2424	12	26-Sep-2015
Programmable Power Supply	Iso-tech	IPS 2010	2435	-	O/P Mon
Hygrometer	Rotronic	I-1000	2891	12	16-Jul-2015
Termination (50ohm, 1W)	Suhner		3080	12	5-Mar-2016
Power Divider	Weinschel	1506A	3345	12	2-Jun-2016
Signal Analyser	Rohde & Schwarz	FSQ 26	3545	12	6-Aug-2015
PXI Digital RF Signal Generator	Aeroflex	3025	4015	24	3-Oct-2015
1800-6000 MHz Power Splitter	Mini-Circuits	ZN2PD-63-S+	4055	-	O/P Mon
1800-6000 MHz Power Splitter	Mini-Circuits	ZN2PD-63-S+	4056	-	O/P Mon
Attenuator	Seaelectro	SO-674-1010-89	N/S	-	TU
30dB Attenuator	Narda	4772-30	463	-	TU
PXI Digital RF Digitizer	Aeroflex	3035	4012	24	3-Oct-2015
PXI Digital RF Signal Generator	Aeroflex	3010	4013	24	3-Oct-2015
PXI Digital RF Signal Generator	Aeroflex	3011	4014	24	3-Oct-2015

TU – Traceability Unscheduled

O/P MON – Output Monitored with Calibrated Equipment



Product Service

**3.2 SUPPORT TEST EQUIPMENT**

Instrument	Manufacturer	Type No.	Serial Number
Access Point	Cisco	AIR-AP1252AG-A-K9	FTX143490WE
Laptop	Fujitsu	Litebook S7220	YKKF052471



Product Service

### 3.3 MEASUREMENT UNCERTAINTY

For a 95% confidence level, the measurement uncertainties for defined systems are:-

Test Discipline	MU
In-Service Monitoring	Time: $\pm 0.47\%$ Power: $\pm 1.29$ dB





Product Service

## **SECTION 4**

### **PHOTOGRAPHS**



Product Service

#### 4.1 TEST SET-UP PHOTOGRAPHS

See test set-up photographs exhibit "75931212 FCC Set Up Photos.pdf".

#### 4.2 DFS TEST EQUIPMENT

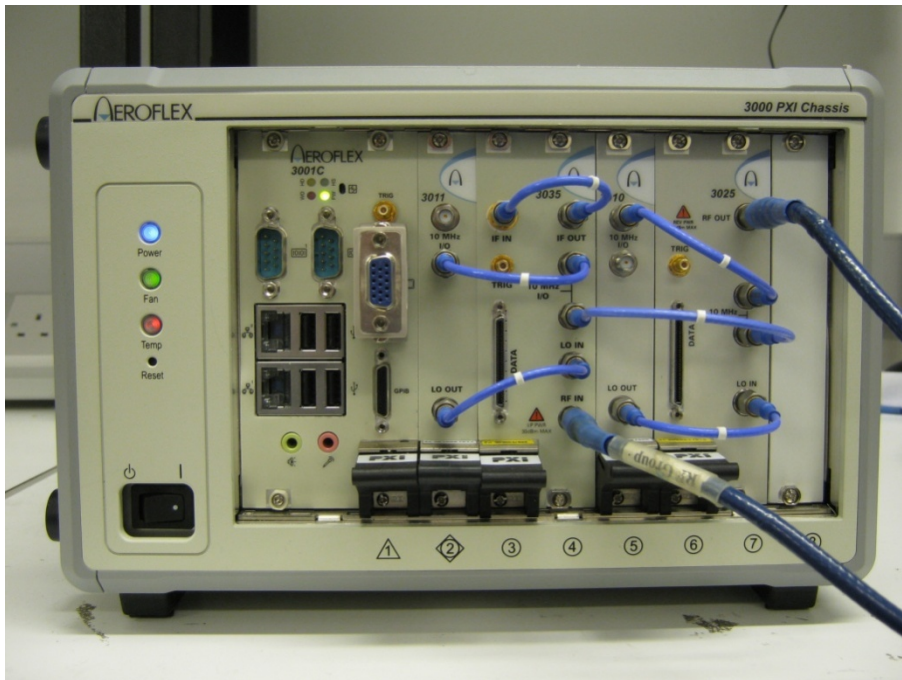

Test Set Up



Product Service

## **SECTION 5**

### **ACCREDITATION, DISCLAIMERS AND COPYRIGHT**



Product Service

## 5.1 ACCREDITATION, DISCLAIMERS AND COPYRIGHT



This report relates only to the actual item/items tested.

Our UKAS Accreditation does not cover opinions and interpretations and any expressed are outside the scope of our UKAS Accreditation.

Results of tests not covered by our UKAS Accreditation Schedule are marked NUA  
(Not UKAS Accredited).

This report must not be reproduced, except in its entirety, without the written permission of  
TÜV SÜD Product Service

© 2015 TÜV SÜD Product Service