

FCC 47 CFR PART 15 SUBPART C
CERTIFICATION TEST REPORT for BT(DTS)

For

Nerve and Muscle Stimulator

MODEL : XFT-2001EA

FCC ID: 2AS2I2001EA

Trade Mark:N/A

REPORT NO: ES190321985W

ISSUE DATE: March 29, 2019

Prepared for

Shenzhen XFT Medical Limited

Room 203, Building 1, Biomedicine Innovations Industrial Park, #14 Jinhui
Road, Pingshan New District, Shenzhen, China

Prepared by

EMTEK(SHENZHEN) CO., LTD.

Bldg 69, Majialong Industry Zone, Nanshan District, Shenzhen,
Guangdong, China

TEL: 86-755-26954280

FAX: 86-755-26954282

Table of Contents

1	TEST RESULT CERTIFICATION	3
2	EUT TECHNICAL DESCRIPTION	4
3	SUMMARY OF TEST RESULT	5
4	TEST METHODOLOGY	6
	4.1 GENERAL DESCRIPTION OF APPLIED STANDARDS	6
	4.2 MEASUREMENT EQUIPMENT USED	6
	4.3 DESCRIPTION OF TEST MODES	7
5	FACILITIES AND ACCREDITATIONS	8
	5.1 FACILITIES	8
	5.2 LABORATORY ACCREDITATIONS AND LISTINGS	8
6	TEST SYSTEM UNCERTAINTY	9
7	SETUP OF EQUIPMENT UNDER TEST	10
	7.1 RADIO FREQUENCY TEST SETUP 1	10
	7.2 RADIO FREQUENCY TEST SETUP 2	10
	7.3 CONDUCTED EMISSION TEST SETUP	11
	7.4 SUPPORT EQUIPMENT	12
8	TEST REQUIREMENTS	13
	8.1 DTS 6DB BANDWIDTH	13
	8.2 MAXIMUM PEAK CONDUCTED OUTPUT POWER	16
	8.3 MAXIMUM POWER SPECTRAL DENSITY	19
	8.4 UNWANTED EMISSIONS IN NON-RESTRICTED FREQUENCY BANDS	22
	8.5 RADIATED SPURIOUS EMISSION	27
	8.6 CONDUCTED EMISSIONS TEST	39
	8.7 ANTENNA APPLICATION	42

1 TEST RESULT CERTIFICATION

Applicant : Shenzhen XFT Medical Limited
 Address : Room 203, Building 1, Biomedicine Innovations Industrial Park, #14 Jinhui Road, Pingshan New District, Shenzhen, China
 Manufacturer : Shenzhen XFT Medical Limited
 Address : Room 203, Building 1, Biomedicine Innovations Industrial Park, #14 Jinhui Road, Pingshan New District, Shenzhen, China
 EUT : Nerve and Muscle Stimulator
 Model Name : XFT-2001EA
 Trademark : N/A

Measurement Procedure Used:

APPLICABLE STANDARDS	
STANDARD	TEST RESULT
FCC 47 CFR Part 2 , Subpart J FCC 47 CFR Part 15, Subpart C	PASS

The above equipment was tested by EMTEK(SHENZHEN) CO., LTD. The test data, data evaluation, test procedures, and equipment configurations shown in this report were made in accordance with the procedures given in ANSI C63.10 (2013) and the energy emitted by the sample EUT tested as described in this report is in compliance with the requirements of FCC Rules Part 2 and Part 15.247

The test results of this report relate only to the tested sample identified in this report

Date of Test : March 18, 2019 to March 28, 2019

Prepared by : 
Sewen Guo /Editor

Reviewer : 
Joe Xia/Editor

Approve & Authorized Signer : 
Lisa Wang/Manager



2 EUT TECHNICAL DESCRIPTION

Trade name :	Foot Drop System
Product Name :	Nerve and Muscle Stimulator
Model :	XFT-2001EA
Device Type :	Bluetooth V4.0
Data Rate :	1Mbps for GFSK modulation
Modulation:	Bluetooth DTS: GFSK
Operating Frequency Range:	2402-2480MHz
Number of Channels:	40 Channels for Bluetooth DTS;
Transmit Power Max:	-12.92 dBm
Antenna Type:	Ceramic chip antenna
Antenna Gain:	0 dBi;
Power supply	<input checked="" type="checkbox"/> DC supply: 5.0V for adapter
	<input checked="" type="checkbox"/> Adapter supply: Model: GTM41078-0605-USB Input: 100-240V,50/60Hz,0.3A Output: 5.0V,1.2A
Battery:	520mAh/3.7V, lithium battery
Temperature Range:	5°C ~ +40C

Note: for more details, please refer to the User's manual of the EUT.

3 SUMMARY OF TEST RESULT

FCC Part Clause	Test Parameter	Verdict
15.247(a)(2)	DTS (6dB) Bandwidth	PASS
15.247(b)(3)	Maximum Peak Conducted Output Power	PASS
15.247(e)	Maximum Power Spectral Density Level	PASS
15.247(d)	Unwanted Emission Into Non-Restricted Frequency Bands	PASS
15.247(d) 15.209	Unwanted Emission Into Restricted Frequency Bands (conducted)	PASS
15.247(d) 15.209	Radiated Spurious Emission	PASS
15.207	Conducted Emission Test	PASS
15.247(b)	Antenna Application	PASS
	NOTE1: N/A (Not Applicable) NOTE2: According to FCC OET KDB 558074, the report use radiated measurements in the restricted frequency bands. In addition, the radiated test is also performed to ensure the emissions emanating from the device cabinet also comply with the applicable limits.	

RELATED SUBMITTAL(S) / GRANT(S):

This submittal(s) (test report) is intended for FCC ID: 2AS2I2001EA filing to comply with Section 15.247 of the FCC Part 15, Subpart C Rules.

4 TEST METHODOLOGY

4.1 GENERAL DESCRIPTION OF APPLIED STANDARDS

According to its specifications, the EUT must comply with the requirements of the following standards:

FCC 47 CFR Part 2, Subpart J

FCC 47 CFR Part 15, Subpart C

FCC KDB 558074 D01 15.247 Meas Guidance v05r02

4.2 MEASUREMENT EQUIPMENT USED

4.2.1 Conducted Emission Test Equipment

EQUIPMENT TYPE	MFR	MODEL NUMBER	SERIAL NUMBER	LAST CAL.	DUE CAL.
Test Receiver	Rohde & Schwarz	ESCS30	828985/018	05/16/2018	05/15/2019
L.I.S.N.	Schwarzbeck	NNLK8129	8129203	05/16/2018	05/15/2019
50Ω Coaxial Switch	Anritsu	MP59B	M20531	05/16/2018	05/15/2019
Pulse Limiter	Rohde & Schwarz	ESH3-Z2	100006	05/16/2018	05/15/2019
Voltage Probe	Rohde & Schwarz	TK9416	N/A	05/16/2018	05/15/2019
I.S.N	Rohde & Schwarz	ENY22	1109.9508.02	05/16/2018	05/15/2019

4.2.2 Radiated Emission Test Equipment

EQUIPMENT TYPE	MFR	MODEL NUMBER	SERIAL NUMBER	LAST CAL.	DUE CAL.
EMI Test Receiver	Rohde & Schwarz	ESU	1302.6005.26	05/16/2018	05/15/2019
Pre-Amplifier	HP	8447D	2944A07999	05/16/2018	05/15/2019
Bilog Antenna	Schwarzbeck	VULB9163	142	05/16/2018	05/15/2019
Loop Antenna	ARA	PLA-1030/B	1029	05/16/2018	05/15/2019
Horn Antenna	Schwarzbeck	BBHA 9170	BBHA9170399	05/16/2018	05/15/2019
Horn Antenna	Schwarzbeck	BBHA 9120	D143	05/16/2018	05/15/2019
Cable	Schwarzbeck	AK9513	ACRX1	05/16/2018	05/15/2019
Cable	Rosenberger	N/A	FP2RX2	05/16/2018	05/15/2019
Cable	Schwarzbeck	AK9513	CRPX1	05/16/2018	05/15/2019
Cable	Schwarzbeck	AK9513	CRRX2	05/16/2018	05/15/2019

4.2.3 Radio Frequency Test Equipment

EQUIPMENT TYPE	MFR	MODEL NUMBER	SERIAL NUMBER	LAST CAL.	DUE CAL.
Spectrum Analyzer	Agilent	E4407B	88156318	05/16/2018	05/15/2019
Signal Analyzer	Agilent	N9010A	My53470879	05/16/2018	05/15/2019
Power meter	Anritsu	ML2495A	0824006	05/16/2018	05/15/2019
Power sensor	Anritsu	MA2411B	0738172	05/16/2018	05/15/2019
Spectrum Analyzer	Rohde & Schwarz	FSV40	100967	05/16/2018	05/15/2019

Remark: Each piece of equipment is scheduled for calibration once a year.

4.3 DESCRIPTION OF TEST MODES

The EUT has been tested under its typical operating condition.

The EUT configuration for testing is installed on RF field strength measurement to meet the Commissions requirement and operating in a manner which intends to maximize its emission characteristics in a continuous normal application.

The Transmitter was operated in the normal operating mode. The TX frequency was fixed which was for the purpose of the measurements.

Test of channel included the lowest and middle and highest frequency to perform the test, then record on this report.

Those data rates (Bluetooth V4.0 DTS :1Mbps) were used for all test.

Pre-defined engineering program for regulatory testing used to control the EUT for staying in continuous transmitting and receiving mode is programmed.

Frequency and Channel list for Bluetooth V4.0 DTS:

Channel	Frequency (MHz)	Channel	Frequency (MHz)	Channel	Frequency (MHz)
0	2402	19	2440
1	2404	20	2442	37	2476
2	2406	21	2444	38	2478
...	39	2480

Note: $f_c = 2402\text{MHz} + k \times 1\text{MHz}$ $k=1$ to 39

Test Frequency and channel for Bluetooth V4.0 DTS:

Lowest Frequency		Middle Frequency		Highest Frequency	
Channel	Frequency (MHz)	Channel	Frequency (MHz)	Channel	Frequency (MHz)
0	2402	20	2442	39	2480

5 FACILITIES AND ACCREDITATIONS

5.1 FACILITIES

All measurement facilities used to collect the measurement data are located at

Bldg 69, Majialong Industry Zone District, Nanshan District, Shenzhen, China

The sites are constructed in conformance with the requirements of ANSI C63.7, ANSI C63.10 and CISPR Publication 22.

5.2 LABORATORY ACCREDITATIONS AND LISTINGS

Site Description

EMC Lab.

: Accredited by CNAS, 2016.10.24
 The certificate is valid until 2022.10.28
 The Laboratory has been assessed and proved to be in compliance with
 CNAS-CL01:2006 (identical to ISO/IEC 17025:2005)
 The Certificate Registration Number is L2291.

Accredited by TUV Rheinland Shenzhen 2016.05.19
 The Laboratory has been assessed according to the requirements
 ISO/IEC 17025.

Accredited by FCC, August 06, 2018
 Designation Number: CN1204
 Test Firm Registration Number: 882943
 Accredited by A2LA, August 31, 2020
 The Certificate Registration Number is 4321.01.

Accredited by Industry Canada, November 09, 2018
 The Conformity Assessment Body Identifier is CN0008.

Name of Firm

: EMTEK (SHENZHEN) CO., LTD.

Site Location

: Bldg 69, Majialong Industry Zone,
 Nanshan District, Shenzhen, Guangdong, China

6 TEST SYSTEM UNCERTAINTY

The following measurement uncertainty levels have been estimated for tests performed on the apparatus:

Test Parameter	Measurement Uncertainty
RF Output Power	±1.0%
Power Spectral Density	±0.9%
Duty Cycle and Tx-Sequence and Tx-Gap	±1.3%
Medium Utilisation Factor	±1.5%
Occupied Channel Bandwidth	±2.3%
Transmitter Unwanted Emission in the Out-of Band	±1.2%
Transmitter Unwanted Emissions in the Spurious Domain	±2.7%
Receiver Spurious Emissions	±2.7%
Temperature	±3.2%
Humidity	±2.5%

Measurement Uncertainty for a level of Confidence of 95%

7 SETUP OF EQUIPMENT UNDER TEST

7.1 RADIO FREQUENCY TEST SETUP 1

The Bluetooth 4.0 DTS component's antenna port(s) of the EUT are connected to the measurement instrument per an appropriate attenuator. The EUT is controlled by PC/software to emit the specified signals for the purpose of measurements.

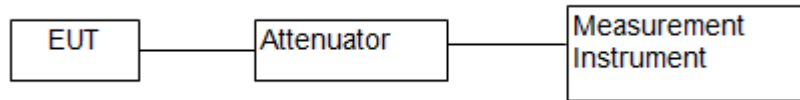

7.2 RADIO FREQUENCY TEST SETUP 2

The test site semi-anechoic chamber has met the requirement of NSA tolerance 4 dB according to the standards: ANSI C63.10. The test distance is 3m. The setup is according to the requirements in Section 13.1.4.1 of ANSI C63.10-2013 and CAN/CSA-CEI/IEC CISPR 22.

Below 30MHz:

The EUT is placed on a turntable 0.8 meters above the ground in the chamber, 3 meter away from the antenna (loop antenna). The Antenna should be positioned with its plane vertical at the specified distance from the EUT and rotated about its vertical axis for maximum response at each azimuth about the EUT. The center of the loop shall be 1 m above the ground. For certain applications, the loop antenna plane may also need to be positioned horizontally at the specified distance from the EUT.

30MHz-1GHz:

The EUT is placed on a turntable 0.8 meters above the ground in the chamber, 3 meter away from the antenna. The maximal emission value is acquired by adjusting the antenna height, polarisation and turntable azimuth. Normally, the height range of antenna is 1 m to 4 m, the azimuth range of turntable is 0° to 360°, and the receive antenna has two polarizations Vertical (V) and Horizontal (H).

Above 1GHz:

The EUT is placed on a turntable 1.5 meters above the ground in the chamber, 3 meter away from the antenna. The maximal emission value is acquired by adjusting the antenna height, polarisation and turntable azimuth. Normally, the height range of antenna is 1 m to 4 m, the azimuth range of turntable is 0° to 360°, and the receive antenna has two polarizations Vertical (V) and Horizontal (H).

(a) Radiated Emission Test Set-Up, Frequency Below 30MHz

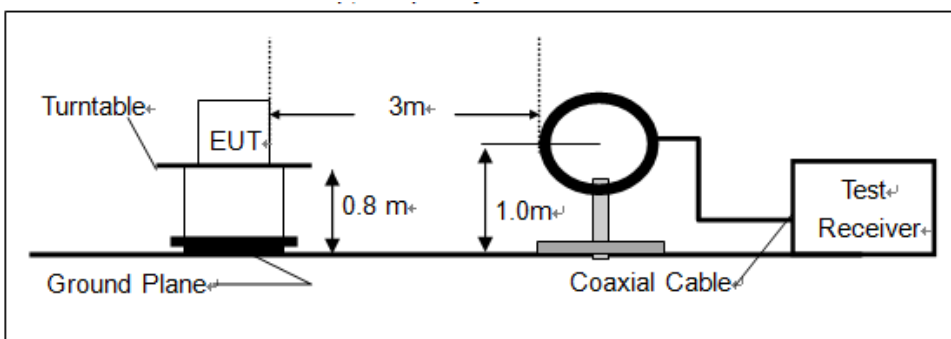

(b) Radiated Emission Test Set-Up, Frequency Below 1000MHz

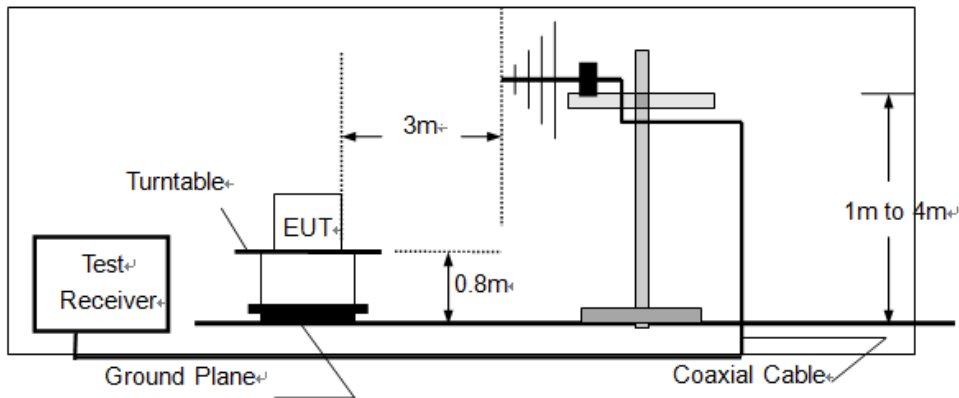

(c) Radiated Emission Test Set-Up, Frequency above 1000MHz

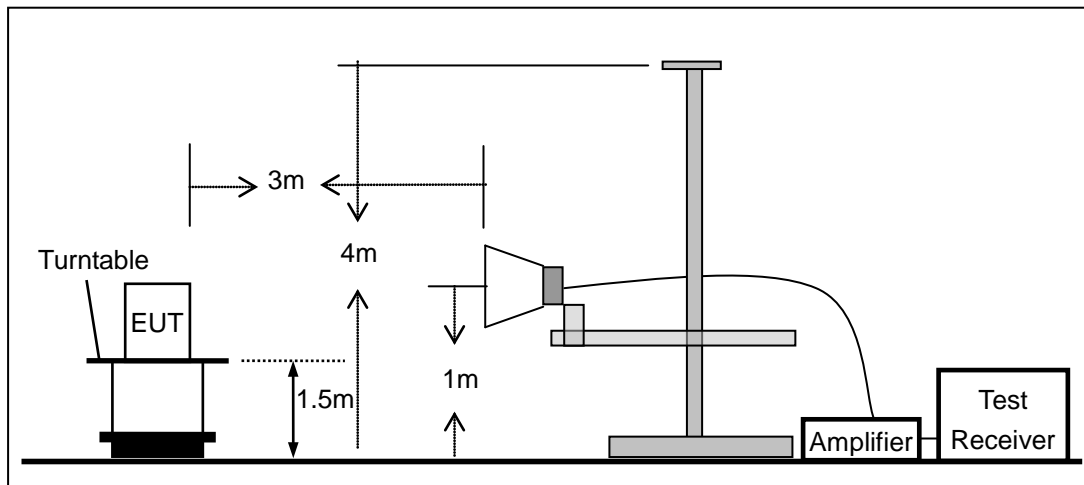

7.3 CONDUCTED EMISSION TEST SETUP

The mains cable of the EUT (maybe per AC/DC Adapter) must be connected to LISN. The LISN shall be placed 0.8 m from the boundary of EUT and bonded to a ground reference plane for LISN mounted on top of the ground reference plane. This distance is between the closest points of the LISN and the EUT. All other units of the EUT and associated equipment shall be at least 0.8m from the LISN.

Ground connections, where required for safety purposes, shall be connected to the reference ground point of the LISN and, where not otherwise provided or specified by the manufacturer, shall be of same length as the mains cable and run parallel to the mains connection at a separation distance of not more than 0.1 m.

According to the requirements in Section 13.1.4.1 of ANSI C63.10-2013 Conducted emissions from the EUT measured in the frequency range between 0.15 MHz and 30 MHz using CISPR Quasi-Peak and average detector mode.

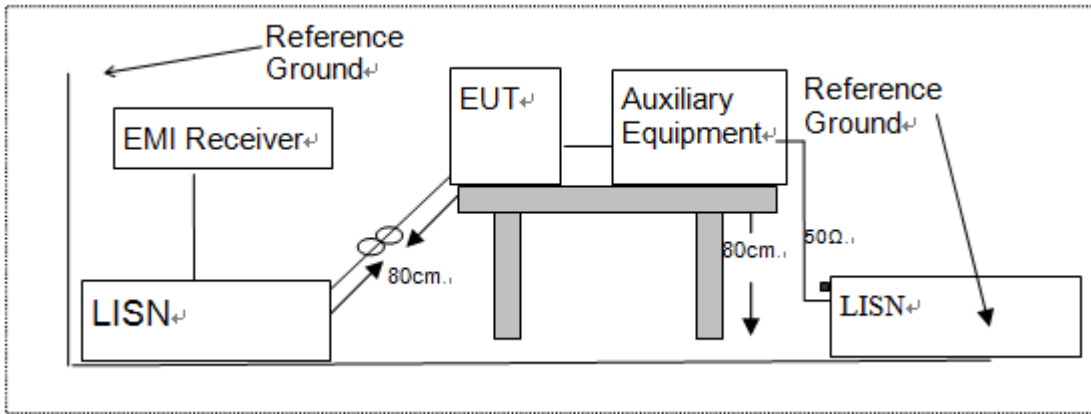

7.4 SUPPORT EQUIPMENT

EUT Cable List and Details			
Cable Description	Length (m)	Shielded/Unshielded	With / Without Ferrite
AC cable	0.8	Unshielded	With Ferrite
/	/	/	/

Auxiliary Cable List and Details			
Cable Description	Length (m)	Shielded/Unshielded	With / Without Ferrite
/	/	/	/

Auxiliary Equipment List and Details			
Description	Manufacturer	Model	Serial Number
Notebook	acer	ZR1	LXTECOCO76643158 372500
/	/	/	/

Notes:

1. All the equipment/cables were placed in the worst-case configuration to maximize the emission during the test.
2. Grounding was established in accordance with the manufacturer's requirements and conditions for the intended use.

8 TEST REQUIREMENTS

8.1 DTS 6DB BANDWIDTH

8.1.1 Applicable Standard

According to FCC Part 15.247(a)(2) and KDB 558074 D01 15.247 Meas Guidance V05r02

8.1.2 Conformance Limit

The minimum -6 dB bandwidth shall be at least 500 kHz.

8.1.3 Test Configuration

Test according to clause 7.1 radio frequency test setup 1

8.1.4 Test Procedure

The EUT was operating in Bluetooth 4.0 DTS mode and controlled its channel. Printed out the test result from the spectrum by hard copy function.

The RF output of EUT was connected to the spectrum analyzer by RF cable and attenuator. The path loss was compensated to the results for each measurement.

Set to the maximum power setting and enable the EUT transmit continuously

Set RBW = 100 kHz.

Set the video bandwidth (VBW) =300 kHz.

Set Span=2 times OBW

Set Detector = Peak.

Set Trace mode = max hold.

Set Sweep = auto couple.

Allow the trace to stabilize.

Measure the maximum width of the emission that is constrained by the frequencies associated with the two outermost amplitude points (upper and lower frequencies) that are attenuated by 6 dB relative to the maximum level measured in the fundamental emission.

Measure and record the results in the test report.

Test Results

Temperature:	26° C
Relative Humidity:	54%
ATM Pressure:	1011 mbar

Operation Mode	Channel Number	Channel Frequency (MHz)	Measurement Bandwidth (kHz)	Limit (kHz)	Verdict
Bluetooth 4.0 DTS	0	2402	686.0	>500	PASS
	20	2442	677.3	>500	PASS
	39	2480	694.6	>500	PASS

Test Model DTS (6dB) Bandwidth
Bluetooth4.0 DTS
Channel 0: 2402MHz

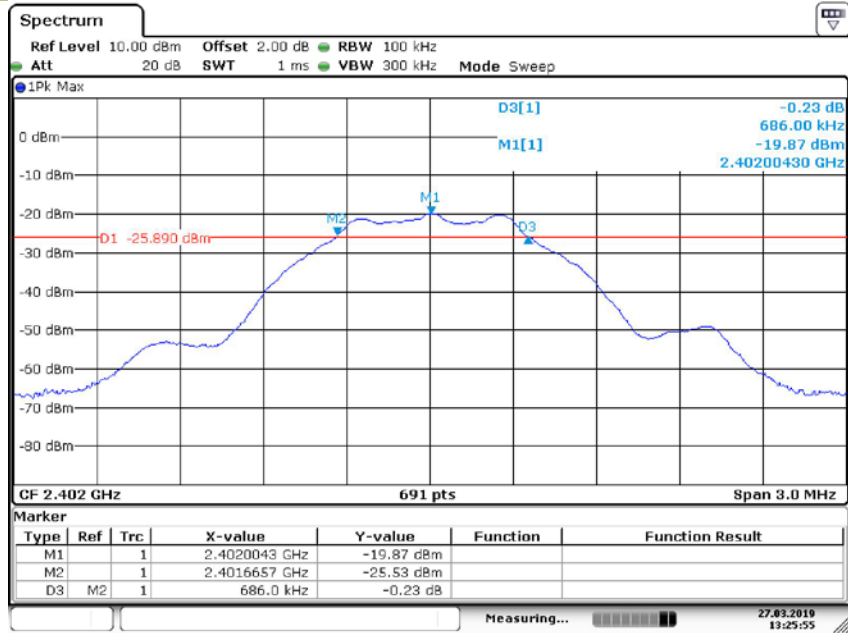

Date: 27.MAR.2019 13:25:55

Test Model DTS (6dB) Bandwidth
Bluetooth4.0 DTS
Channel 20: 2442MHz

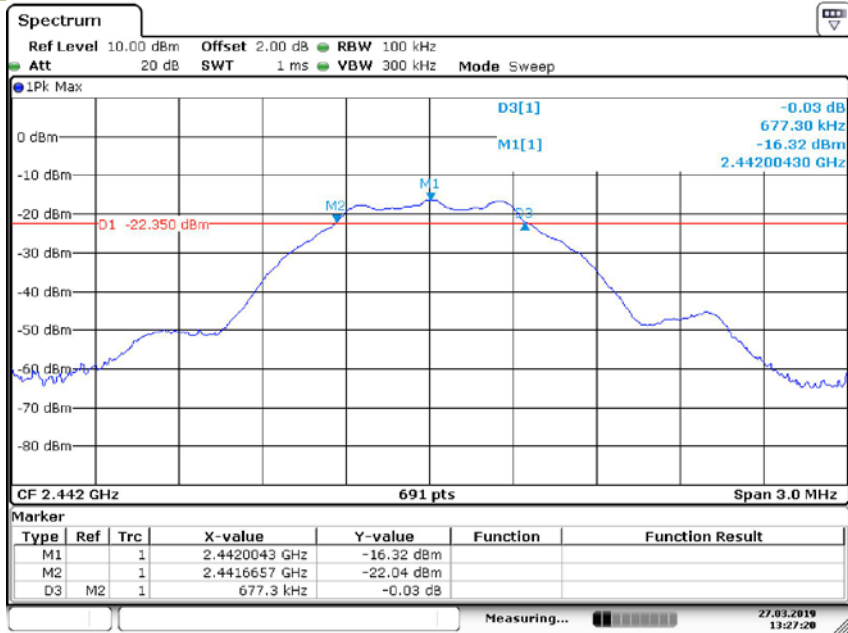

Date: 27.MAR.2019 13:27:19

Test Model

DTS (6dB) Bandwidth
BluetoothV4.0 DTS
Channel 39: 2480MHz

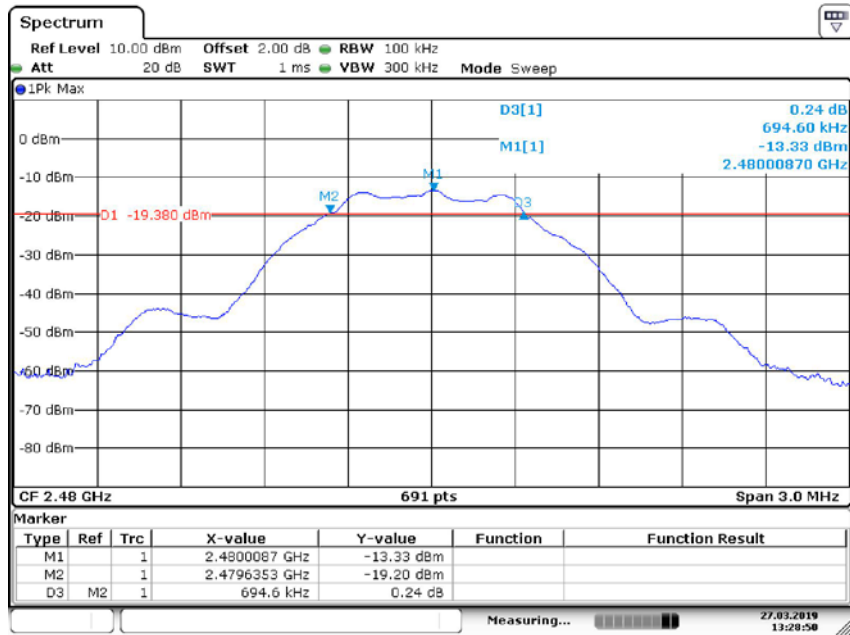

Date: 27.MAR.2019 13:28:50

8.2 MAXIMUM PEAK CONDUCTED OUTPUT POWER

8.2.1 Applicable Standard

According to FCC Part 15.247(b)(3) and KDB 558074 D01 15.247 Meas Guidance V05r02

8.2.2 Conformance Limit

The maximum peak conducted output power of the intentional radiator for systems using digital modulation in the 2400 - 2483.5 MHz bands shall not exceed: 1 Watt (30dBm).

8.2.3 Test Configuration

Test according to clause 7.1 radio frequency test setup 1

8.2.4 Test Procedure

■ According to FCC Part 15.247(b)(3)

As an alternative to a peak power measurement, compliance with the one Watt limit can be based on a measurement of the maximum conducted output power. For smart system, Maximum Conducted Output Power is defined as the total transmit power delivered to all antennas and antenna elements averaged across all symbols in the signaling alphabet when the transmitter is operating at its maximum power control level. Power must be summed across all antennas and antenna elements. If multiple modes of operation are possible (e.g., alternative modulation methods), the maximum conducted output power is the highest total transmit power occurring in any mode.

Set the RBW \geq DTS bandwidth (about 1MHz).

Set VBW \approx 3*RBW (about 3MHz)

Set the span \geq 3*RBW

Set Sweep time = auto couple.

Set Detector = peak.

Set Trace mode = max hold.

Allow trace to fully stabilize. Use peak marker function to determine the peak amplitude level.

■ According to FCC Part 15.247(b)(4):

Conducted output power limit specified in paragraph (b) of this section is based on the use of antennas with directional gains that do not exceed 6 dBi. If transmitting antennas of directional gain greater than 6 dBi are used, the conducted output power from the intentional radiator shall be reduced below the stated values in paragraphs (b)(3) of this section, as appropriate, by the amount in dB that the directional gain of the antenna exceeds 6 dBi.

Test Results

Temperature:	26° C
Relative Humidity:	54%
ATM Pressure:	1011 mbar

Operation Mode	Channel Number	Channel Frequency (MHz)	Measurement Level (dBm)	Limit (dBm)	Verdict
Bluetooth V4.0 DTS	0	2402	-19.31	30	PASS
	20	2442	-15.80	30	PASS
	39	2480	-12.92	30	PASS

Test Model	Maximum Conducted Output Power	
	Bluetooth4.0 DTS	
	Channel 0: 2402MHz	GFSK modulation

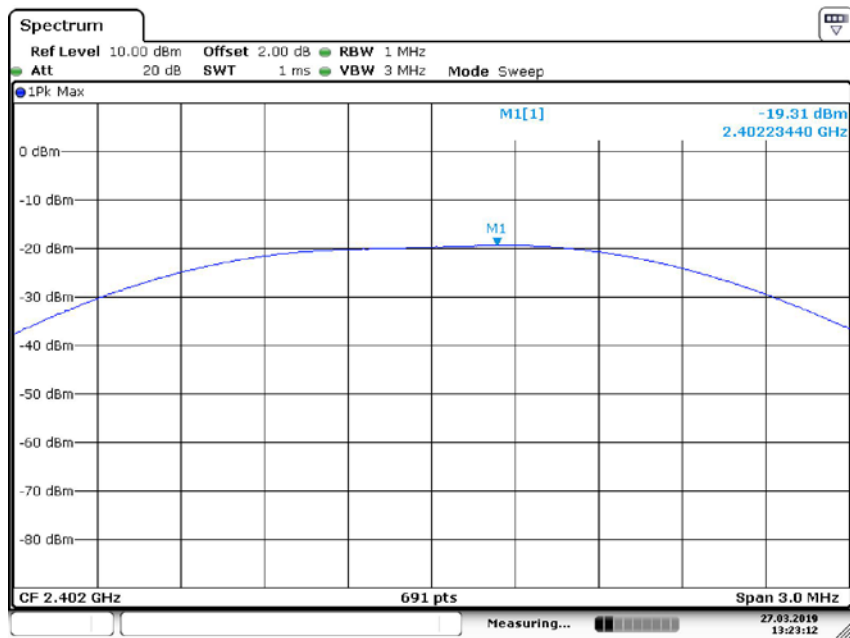

Date: 27.MAR.2019 13:23:12

Test Model	Maximum Conducted Output Power	
	Bluetooth4.0 DTS	
	Channel 20: 2442MHz	GFSK modulation

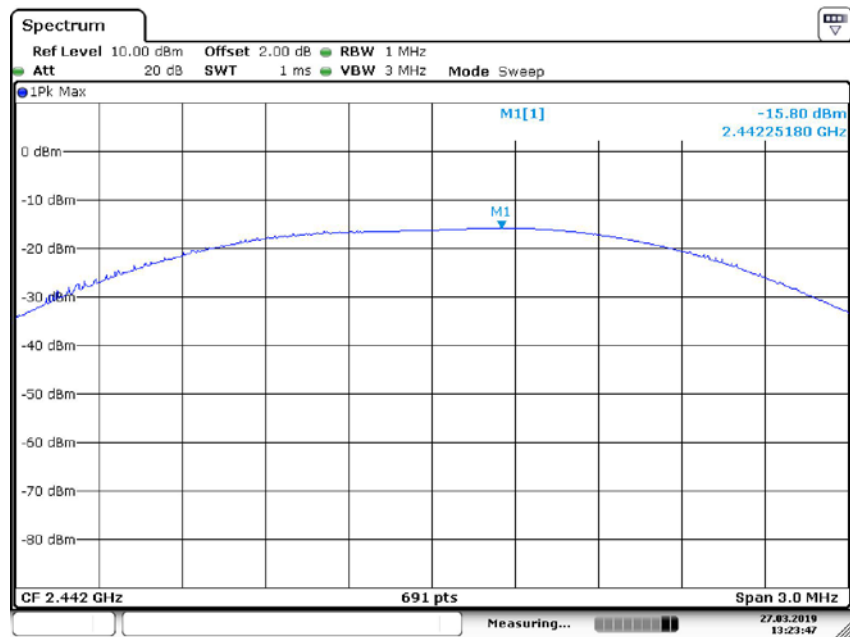

Date: 27.MAR.2019 13:23:47

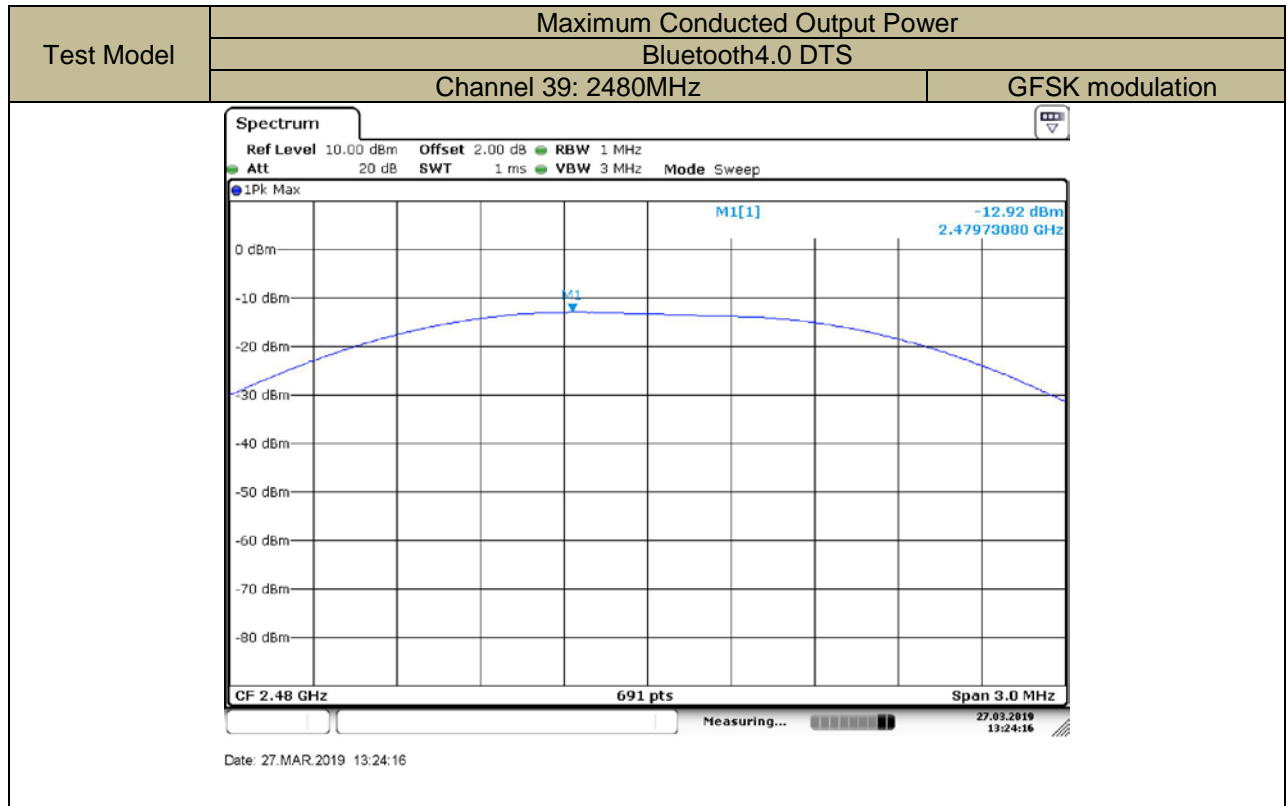

8.3 MAXIMUM POWER SPECTRAL DENSITY

8.3.1 Applicable Standard

According to FCC Part 15.247(e) and KDB 558074 D01 15.247 Meas Guidance V05r02

8.3.2 Conformance Limit

The transmitter power spectral density conducted from the transmitter to the antenna shall not be greater than 8 dBm in any 3 kHz band during any time interval of continuous transmission.

8.3.3 Test Configuration

Test according to clause 7.1 radio frequency test setup 1

8.3.4 Test Procedure

This procedure shall be used if maximum peak conducted output power was used to demonstrate compliance

The transmitter output (antenna port) was connected to the spectrum analyzer

Set analyzer center frequency to DTS channel center frequency.

Set the span to 1.5 times the DTS bandwidth.

Set the RBW to: 3 kHz

Set the VBW to: 10 kHz.

Set Detector = peak.

Set Sweep time = auto couple.

Set Trace mode = max hold.

Allow trace to fully stabilize.

Use the peak marker function to determine the maximum amplitude level within the RBW.

8.3.5 Test Results

Temperature:	26° C
Relative Humidity:	54%
ATM Pressure:	1011 mbar

Operation Mode	Channel Number	Channel Frequency (MHz)	Measurement Level (dBm/3kHz)	Limit (dBm/3kHz)	Verdict
Bluetooth 4.0 DTS	0	2402	-34.94	<8	PASS
	20	2442	-31.53	<8	PASS
	39	2480	-28.36	<8	PASS
Note: N/A					

Test Model Power Spectral Density
Bluetooth 4.0 DTS
Channel 0: 2402MHz

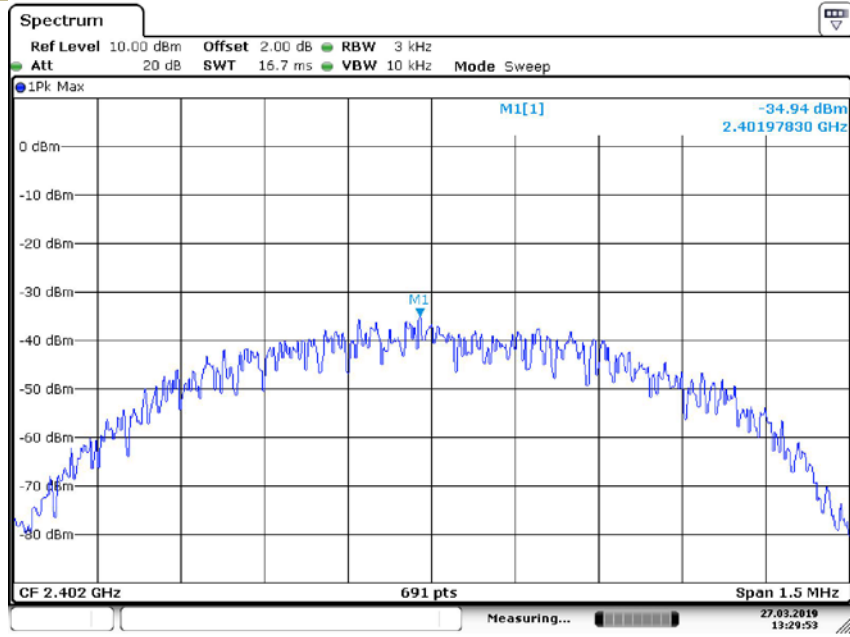

Date: 27.MAR.2019 13:29:53

Test Model Power Spectral Density
Bluetooth 4.0 DTS
Channel 20: 2442MHz

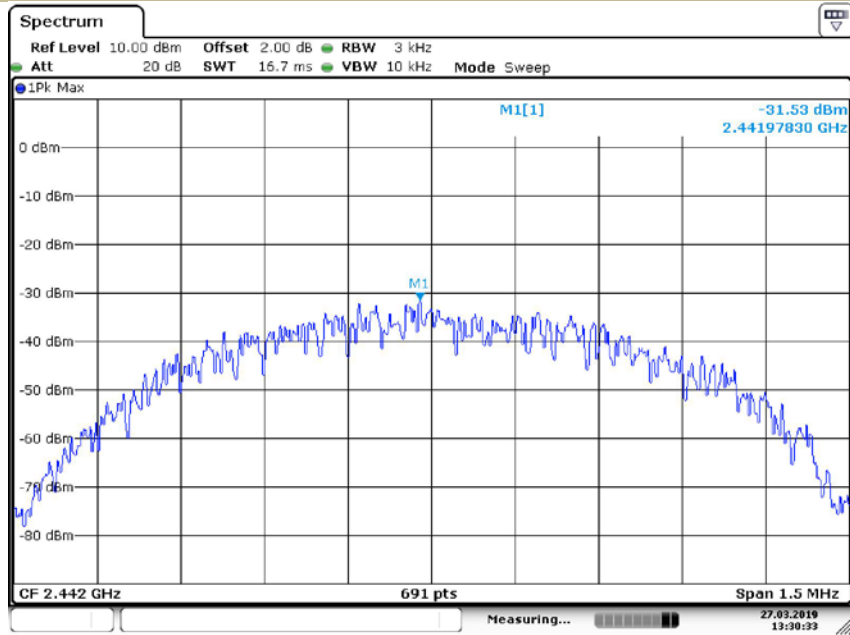

Date: 27.MAR.2019 13:30:33

Test Model

Power Spectral Density
Bluetooth 4.0 DTS
Channel 39: 2480MHz

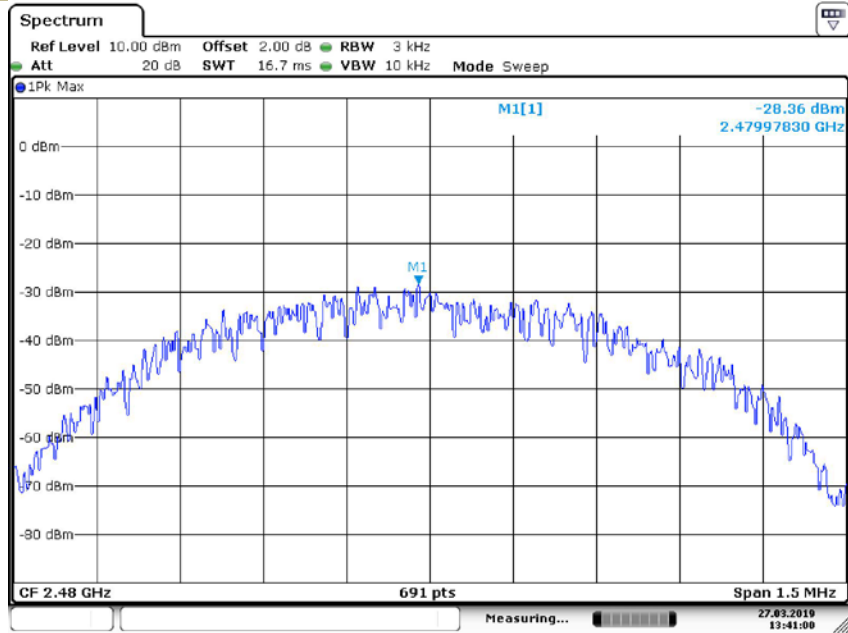

Date: 27.MAR.2019 13:41:00

8.4 UNWANTED EMISSIONS IN NON-RESTRICTED FREQUENCY BANDS

8.4.1 Applicable Standard

According to FCC Part 15.247(d) and KDB 558074 D01 15.247 Meas Guidance V05r02

8.4.2 Conformance Limit

According to FCC Part 15.247(d):

In any 100 kHz bandwidth outside the frequency band in which the spread spectrum or digitally modulated intentional radiator is operating, the radio frequency power that is produced by the intentional radiator shall be at least 20 dB below that in the 100 kHz bandwidth within the band that contains the highest level of the desired power, based on either an RF conducted or a radiated measurement, provided the transmitter demonstrates compliance with the peak conducted power limits. If the transmitter complies with the conducted power limits based on the use of RMS averaging over a time interval, as permitted under paragraph (b)(3) of this section, the attenuation required under this paragraph shall be 30 dB instead of 20 dB.

8.4.3 Test Configuration

Test according to clause 7.1 radio frequency test setup 1

8.4.4 Test Procedure

The transmitter output (antenna port) was connected to the spectrum analyzer

■ Reference level measurement

Establish a reference level by using the following procedure:

Set instrument center frequency to DTS channel center frequency.

Set the span to = 1.5 times the DTS bandwidth.

Set the RBW = 100 kHz.

Set the VBW $\geq 3 \times$ RBW.

Set Detector = peak.

Set Sweep time = auto couple.

Set Trace mode = max hold.

Allow trace to fully stabilize.

Use the peak marker function to determine the maximum PSD level.

Note that the channel found to contain the maximum PSD level can be used to establish the reference level.

■ Emission level measurement

Set the center frequency and span to encompass frequency range to be measured.

Set the RBW = 100 kHz.

Set the VBW = 300 kHz.

Set Detector = peak

Sweep time = auto couple.

Trace mode = max hold.

Allow trace to fully stabilize.

Use the peak marker function to determine the maximum amplitude level.

Ensure that the amplitude of all unwanted emissions outside of the authorized frequency band (excluding restricted frequency bands) are attenuated by at least the minimum requirements . Report the three highest emissions relative to the limit.

8.4.5 Test Results

Temperature:	26° C
Relative Humidity:	54%
ATM Pressure:	1011 mbar

Test Model PSD(Power Spectral Density) RBW=100kHz
Bluetooth 4.0 DTS
Channel 0: 2402MHz

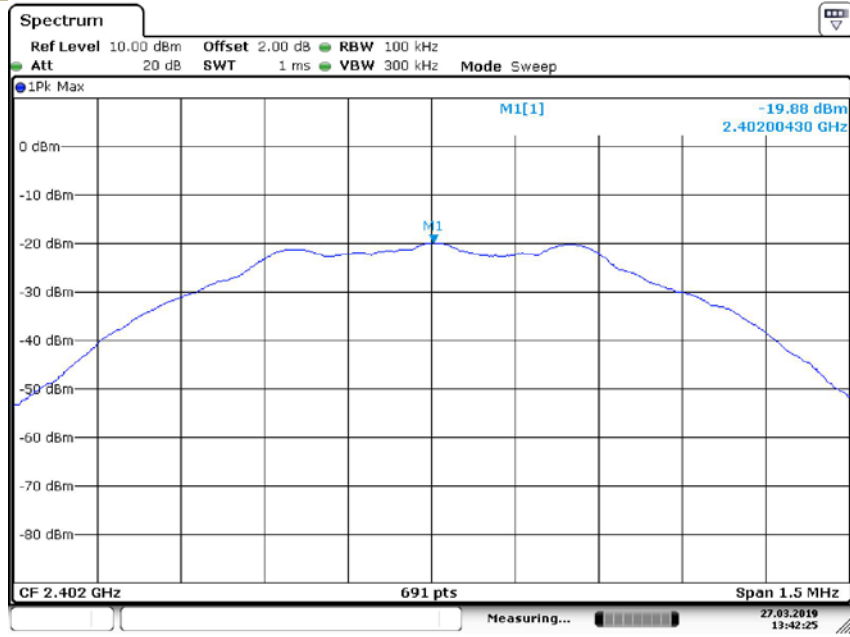

Date: 27.MAR.2019 13:42:25

Test Model Unwanted Emissions in non-restricted frequency bands
Bluetooth 4.0 DTS
Channel 0: 2402MHz

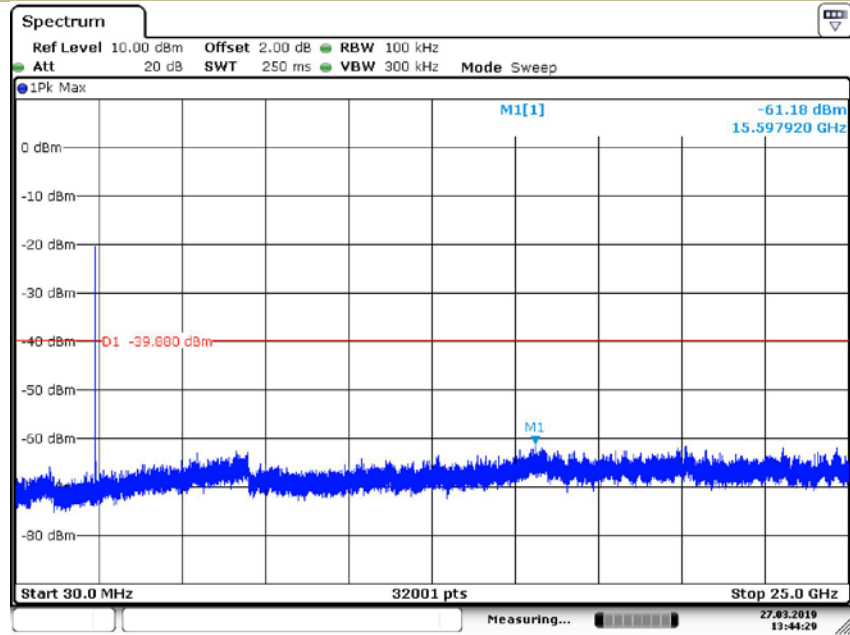

Date: 27.MAR.2019 13:44:29

Test Model Band edge
Bluetooth 4.0 DTS
Channel 0: 2402MHz

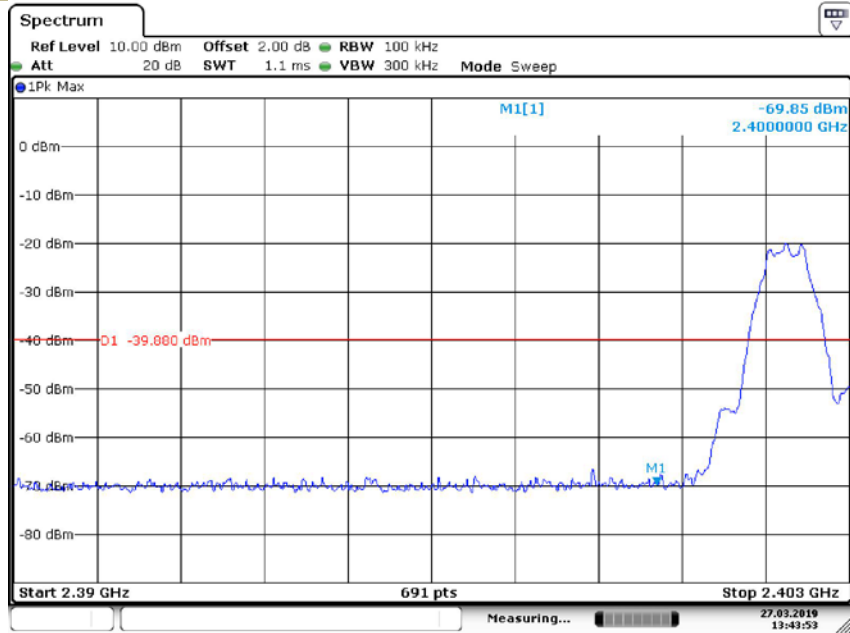

Date: 27.MAR.2019 13:43:53

Test Model PSD(Power Spectral Density) RBW=100kHz
Bluetooth 4.0 DTS
Channel 20: 2442MHz

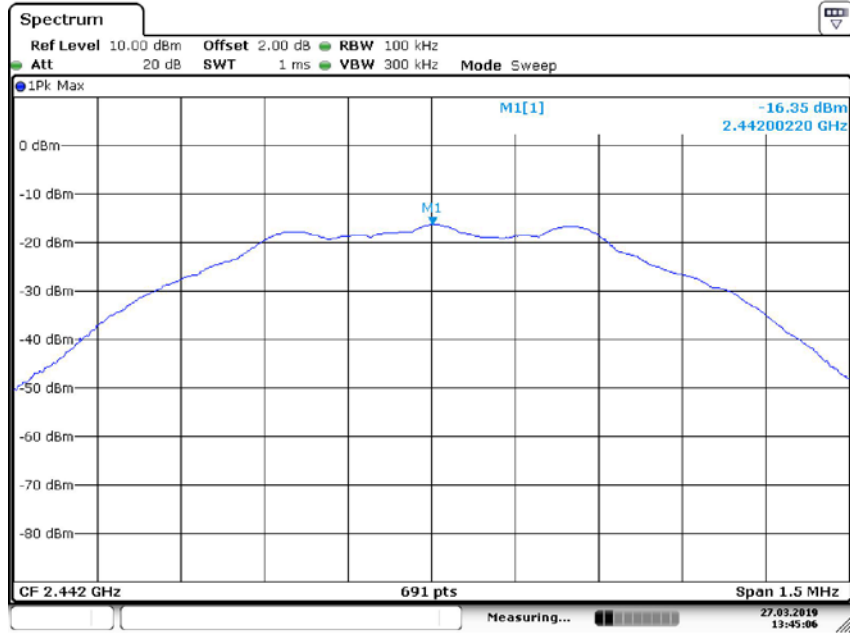

Date: 27.MAR.2019 13:45:07

Test Model Unwanted Emissions In Non-Restricted Frequency Bands
Bluetooth 4.0 DTS
Channel 20: 2442MHz

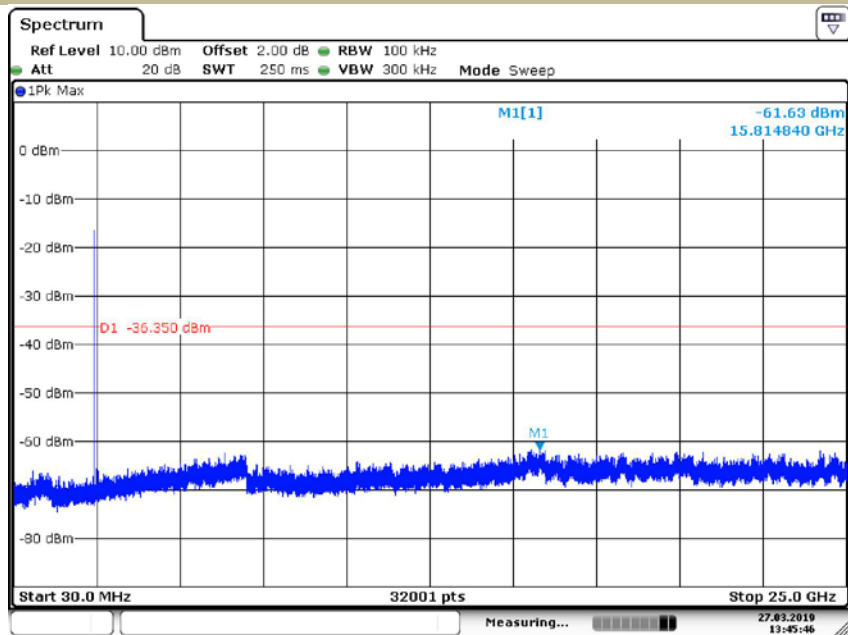

Date: 27.MAR.2019 13:45:46

Test Model PSD(Power Spectral Density) RBW=100kHz
Bluetooth 4.0 DTS
Channel 39: 2480MHz

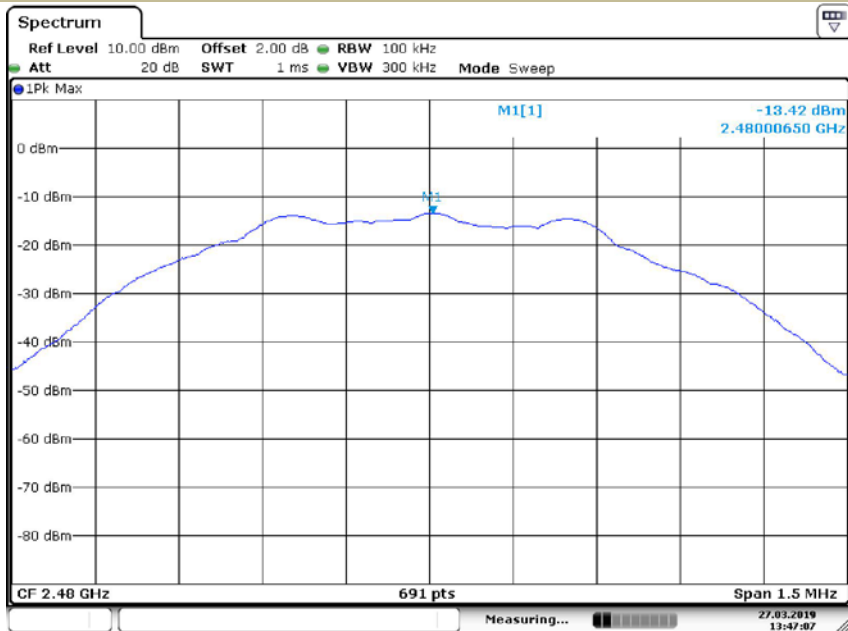

Date: 27.MAR.2019 13:47:07

Test Model Unwanted Emissions In Non-Restricted Frequency Bands
Bluetooth 4.0 DTS
Channel 39: 2480MHz

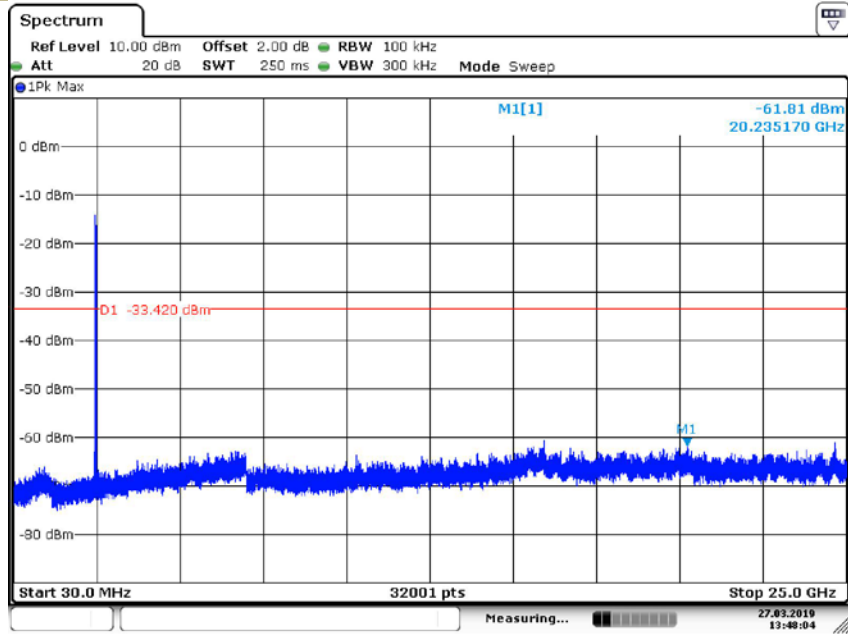

Date: 27.MAR.2019 13:48:04

Test Model Band edge
Bluetooth 4.0 DTS
Channel 39: 2480MHz

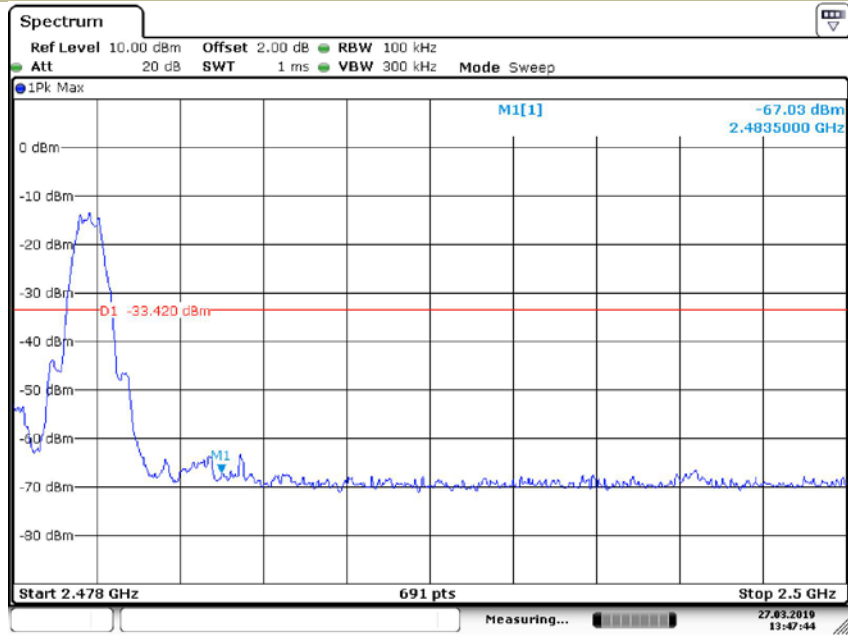

Date: 27.MAR.2019 13:47:44

8.5 RADIATED SPURIOUS EMISSION

8.5.1 Applicable Standard

According to FCC Part 15.247(d) and 15.209 and KDB 558074 D01 15.247 Meas Guidance V05r02

8.5.2 Conformance Limit

According to FCC Part 15.247(d): radiated emissions which fall in the restricted bands, as defined in §15.205(a), must also comply with the radiated emission limits specified in §15.209(a) (see §15.205(c)).

According to FCC Part 15.205, Restricted bands

MHz	MHz	MHz	GHz
0.090-0.110	16.42-16.423	399.9-410	4.5-5.15
10.495-0.505	16.69475-16.69525	608-614	5.35-5.46
2.1735-2.1905	16.80425-16.80475	960-1240	7.25-7.75
4.125-4.128	25.5-25.67	1300-1427	8.025-8.5
4.17725-4.17775	37.5-38.25	1435-1626.5	9.0-9.2
4.20725-4.20775	73-74.6	1645.5-1646.5	9.3-9.5
6.215-6.218	74.8-75.2	1660-1710	10.6-12.7
6.26775-6.26825	123-138	2200-2300	14.47-14.5
8.291-8.294	149.9-150.05	2310-2390	15.35-16.2
8.362-8.366	156.52475-156.52525	2483.5-2500	17.7-21.4
8.37625-8.38675	156.7-156.9	2690-2900	22.01-23.12
8.41425-8.41475	162.0125-167.17	3260-3267	23.6-24.0
12.29-12.293	167.72-173.2	3332-3339	31.2-31.8
12.51975-12.52025	240-285	3345.8-3358	36.43-36.5
12.57675-12.57725	322-335.4	3600-4400	(2)
13.36-13.41			

According to FCC Part 15.205, the level of any transmitter spurious emission in Restricted bands shall not exceed the level of the emission specified in the following table

Restricted Frequency(MHz)	Field Strength ($\mu\text{V/m}$)	Field Strength ($\text{dB}\mu\text{V/m}$)	Measurement Distance
0.009-0.490	2400/F(KHz)	20 log ($\mu\text{V/m}$)	300
0.490-1.705	2400/F(KHz)	20 log ($\mu\text{V/m}$)	30
1.705-30	30	29.5	30
30-88	100	40	3
88-216	150	43.5	3
216-960	200	46	3
Above 960	500	54	3

8.5.3 Test Configuration

Test according to clause 7.2 radio frequency test setup 2

8.5.4 Test Procedure

This test is required for any spurious emission that falls in a Restricted Band, as defined in Section 15.205. It must be performed with the highest gain of each type of antenna proposed for use with the EUT. Use the following spectrum analyzer settings:

The EUT was placed on a turn table which is 0.8m above ground plane.

Maximum procedure was performed on the highest emissions to ensure EUT compliance.

Span = wide enough to fully capture the emission being measured

RBW = 1 MHz for $f \geq 1$ GHz(1GHz to 25GHz), 100 kHz for $f < 1$ GHz(30MHz to 1GHz)

VBW \geq RBW

Sweep = auto

Detector function = peak

Trace = max hold

Follow the guidelines in ANSI C63.10-2013 with respect to maximizing the emission by rotating the EUT, measuring the emission while the EUT is situated in three orthogonal planes (if appropriate), adjusting the measurement antenna height and polarization, etc. A pre-amp and a high pass filter are required for this test, in order to provide the measuring system with sufficient sensitivity. Allow the trace to stabilize. The peak reading of the emission, after being corrected by the antenna factor, cable loss, pre-amp gain, etc., is the peak field strength, which must comply with the limit specified in Section 15.35(b). Submit this data. Now set the VBW to 10 Hz, while maintaining all of the other instrument settings. This peak level, once corrected, must comply with the limit specified in Section 15.209. If the dwell time per channel of the hopping signal is less than 100 ms, then the reading obtained with the 10 Hz VBW may be further adjusted by a “duty cycle correction factor”, derived from $20\log(\text{dwell time}/100 \text{ ms})$, in an effort to demonstrate compliance with the 15.209 limit. Submit this data. Repeat above procedures until all frequency measured was complete.

8.5.5 Test Results

Temperature:	26° C
Relative Humidity:	54%
ATM Pressure:	1011 mbar

■ Spurious Emission below 30MHz (9KHz to 30MHz)

Freq. (MHz)	Ant.Pol. H/V	Emission Level(dBuV/m)		Limit 3m(dBuV/m)		Over(dB)	
		PK	AV	PK	AV	PK	AV
--	--	--	--	--	--	--	--

Note: the amplitude of spurious emission that is attenuated by more than 20dB below the permissible limit has no need to be reported.

Distance extrapolation factor = $40\log(\text{Specific distance}/ \text{test distance})(\text{dB})$;

Limit line=Specific limits(dBuV) + distance extrapolation factor

■ Spurious Emission Above 1GHz (1GHz to 25GHz)

Bluetooth 4.0 DTS mode have been tested, and the worst result was report as below:

Test mode: BLE Frequency: Channel 0: 2402MHz

Freq. (MHz)	Ant.Pol. H/V	Emission Level(dBuV/m)		Limit 3m(dBuV/m)		Over(dB)	
		PK	AV	PK	AV	PK	AV
4804.00	V	55.73	43.12	74	54	-18.27	-10.88
7206.00	V	53.41	39.3	74	54	-20.59	-14.70
9608.00	V	49.8	37.45	74	54	-24.20	-16.55
4804.00	H	56.35	41.70	74	54	-17.65	-12.30
7206.00	H	53.92	39.27	74	54	-20.08	-14.73
9608.00	H	50.15	35.63	74	54	-23.85	-18.37

Test mode: BLE Frequency: Channel 20: 2442MHz

Freq. (MHz)	Ant.Pol. H/V	Emission Level(dBuV/m)		Limit 3m(dBuV/m)		Over(dB)	
		PK	AV	PK	AV	PK	AV
4884.00	V	56.61	41.7	74	54	-17.39	-12.30
7326.00	V	50.11	40.85	74	54	-23.89	-13.15
9768.00	V	47.39	35.95	74	54	-26.61	-18.05
4884.00	H	56.51	42.08	74	54	-17.49	-11.92
7326.00	H	53.55	40.61	74	54	-20.45	-13.39
9768.00	H	50.66	36.27	74	54	-23.34	-17.73

Test mode: BLE

Frequency:

Channel 39: 2480MHz

Freq. (MHz)	Ant.Pol. H/V	Emission Level(dBuV/m)		Limit 3m(dBuV/m)		Over(dB)	
		PK	AV	PK	AV	PK	AV
4960.00	V	58.26	42.07	74	54	-15.74	-11.93
7440.00	V	52.16	40.06	74	54	-21.84	-13.94
9920.00	V	50.63	36.38	74	54	-23.37	-17.62
4960.00	H	57.52	42.35	74	54	-16.48	-11.65
7440.00	H	52.31	38.42	74	54	-21.69	-15.58
9920.00	H	49.78	36.52	74	54	-24.22	-17.48

- Note:**
- (1) All Readings are Peak Value (VBW=3MHz) and Peak Value (VBW=10Hz).
 - (2) Emission Level= Reading Level+Correct Factor +Cable Loss.
 - (3) Correct Factor= Ant_F + Cab_L - Preamp
 - (4)Data of measurement within this frequency range shown "--" in the table above means the reading of emissions are attenuated more than 20dB below the permissible limits or the field strength is too small to be measured.

■ Spurious Emission in Restricted Band 2310-2390MHz and 2483.5-2500MHz

Frequency (MHz)	Polarity	PK(dBuV/m) (VBW=3MHz)	Limit 3m (dBuV/m)	Margin (dB)	AV(dBuV/m) (VBW=10Hz)	Limit 3m (dBuV/m)	Margin (dB)
2390.00	H	47.77	74	-26.23	35.94	54	-18.06
2390.00	V	49.01	74	-24.99	36.34	54	-17.66

Frequency (MHz)	Polarity	PK(dBuV/m) (VBW=3MHz)	Limit 3m (dBuV/m)	Margin (dB)	AV(dBuV/m) (VBW=10Hz)	Limit 3m (dBuV/m)	Margin (dB)
2483.50	H	48.09	74	-25.91	36.46	54	-17.54
2483.50	V	48.95	74	-25.05	35.94	54	-18.06

- Note:**
- (1) All Readings are Peak Value (VBW=3MHz) and Peak Value (VBW=10Hz).
 - (2) Emission Level= Reading Level+Correct Factor +Cable Loss.
 - (3) Correct Factor= Ant_F + Cab_L - Preamp
 - (4)Data of measurement within this frequency range shown “ -- ” in the table above means the reading of emissions are attenuated more than 20dB below the permissible limits or the field strength is too small to be measured.

All the modulation modes were tested, the data of the worst mode are described in the following table

Test Model Spurious Emission in Restricted Band 2310-2390MHz
Bluetooth 4.0 DTS
 Channel 0: 2402MHz H

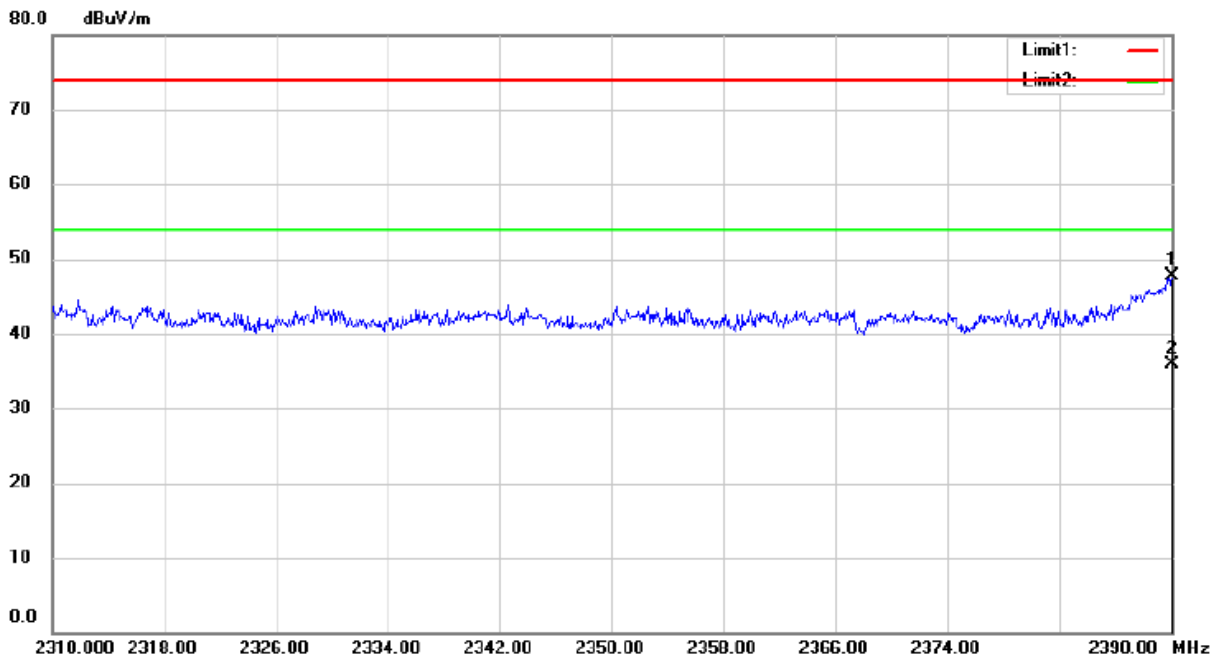

Site 3m Chamber 1# Polarization: **Horizontal** Temperature: 24 C
 Limit: (RE)FCC PART 15C Power: AC 120V/60Hz Humidity: 53 %

Test Model Spurious Emission in Restricted Band 2310-2390MHz
Bluetooth 4.0 DTS
 Channel 0: 2402MHz V

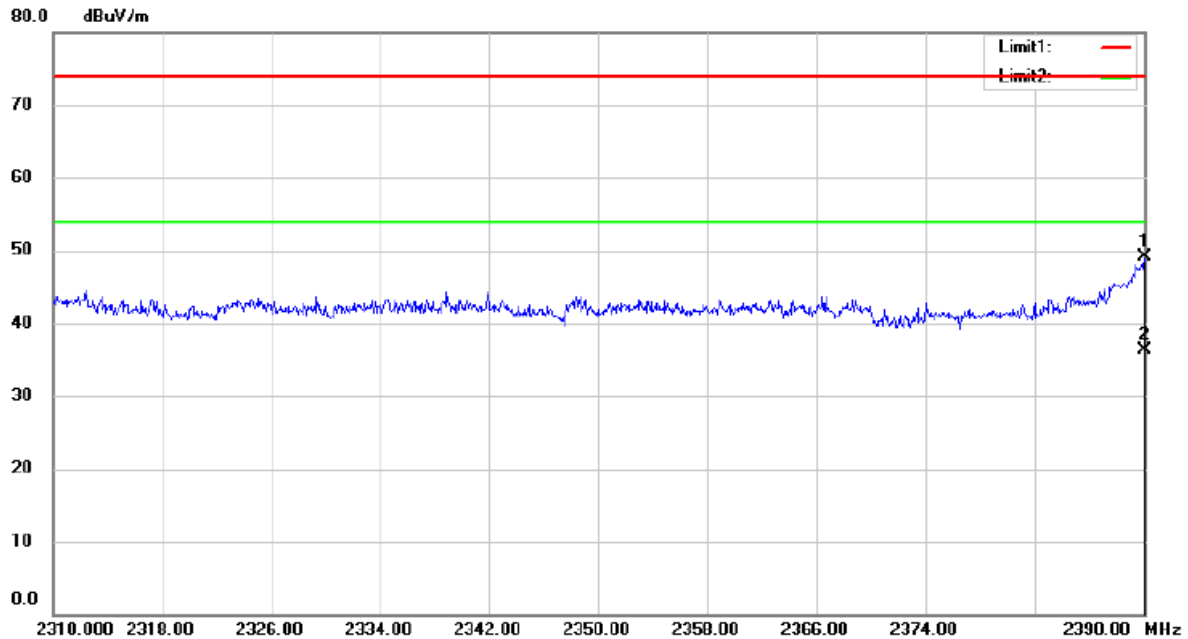

Site 3m Chamber 1# Polarization: **Vertical** Temperature: 24 C
 Limit: (RE)FCC PART 15C Power: AC 120V/60Hz Humidity: 53 %

Spurious Emission in Restricted Band 2483.5-2500MHz
Bluetooth 4.0 DTS
Channel 39: 2480MHz H

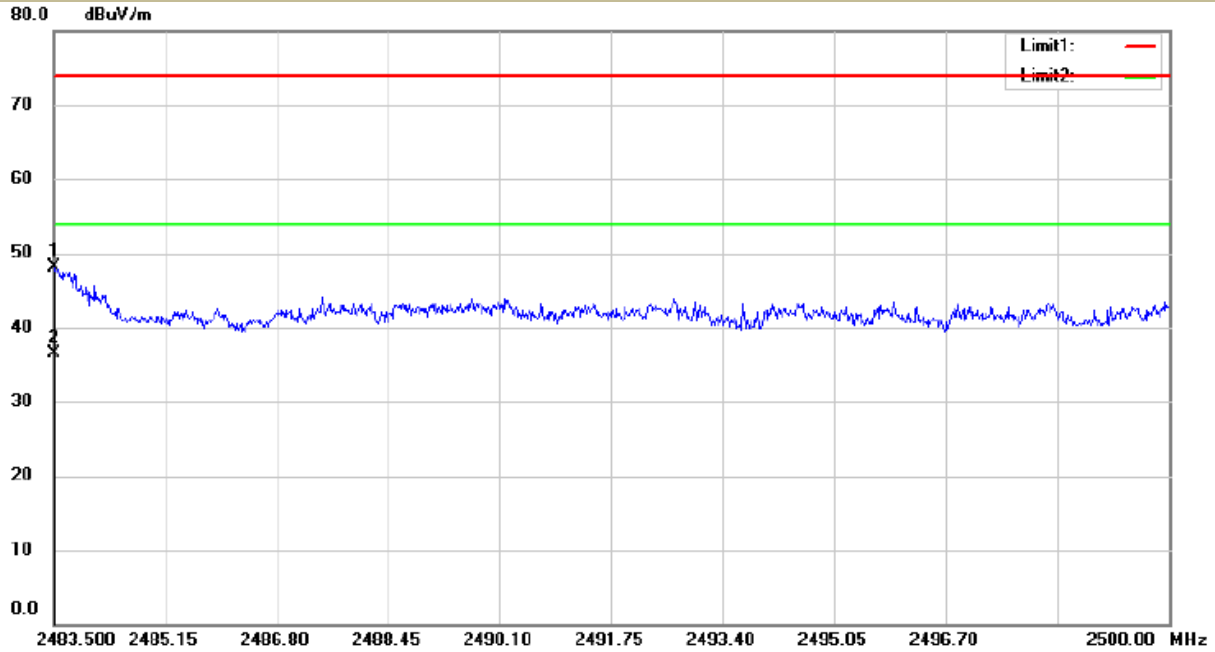

Site 3m Chamber 1# Polarization: **Horizontal** Temperature: 24 C
Limit: (RE)FCC PART 15C Power: AC 120V/60Hz Humidity: 53 %

Spurious Emission in Restricted Band 2483.5-2500MHz
Bluetooth 4.0 DTS
Channel 39: 2480MHz V

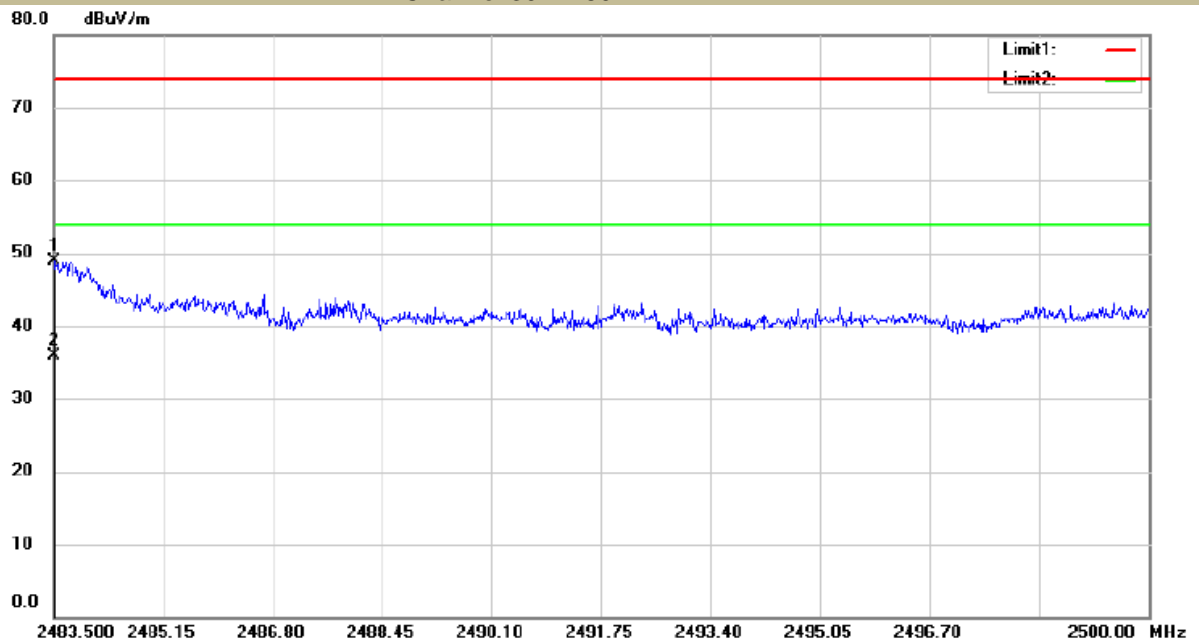

Site 3m Chamber 1# Polarization: **Vertical** Temperature: 24 C
Limit: (RE)FCC PART 15C Power: AC 120V/60Hz Humidity: 53 %

■ Spurious Emission below 1GHz (30MHz to 1GHz)

All modes have been tested, and the worst result recorded was report as below:

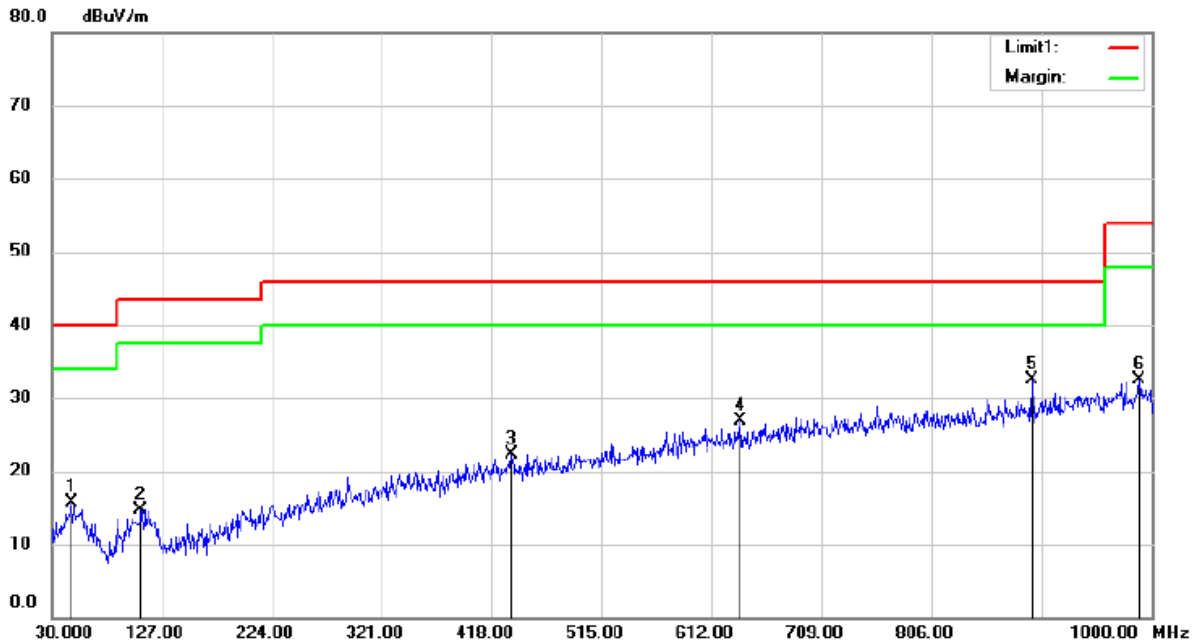

Site 3m Chamber 1#

Polarization: *Horizontal*

Temperature: 27 C

Limit: (RE)FCC PART 15 C

Power: AC 120V/60Hz

Humidity: 43 %

Mode:TX2402MHz

Note:

No.	Mk.	Freq. MHz	Reading Level dBuV	Correct Factor dB	Measure- ment dBuV/m	Limit dBuV/m	Over dB	Antenna Height cm	Table Degree	Detector	Comment
1		48.1875	26.86	-11.19	15.67	40.00	-24.33			QP	
2		109.1762	27.23	-12.51	14.72	43.50	-28.78			QP	
3		435.4600	27.64	-5.37	22.27	46.00	-23.73			QP	
4		637.9474	28.66	-1.78	26.88	46.00	-19.12			QP	
5	*	894.6337	30.58	1.87	32.45	46.00	-13.55			QP	
6		989.2087	28.78	3.75	32.53	54.00	-21.47			QP	

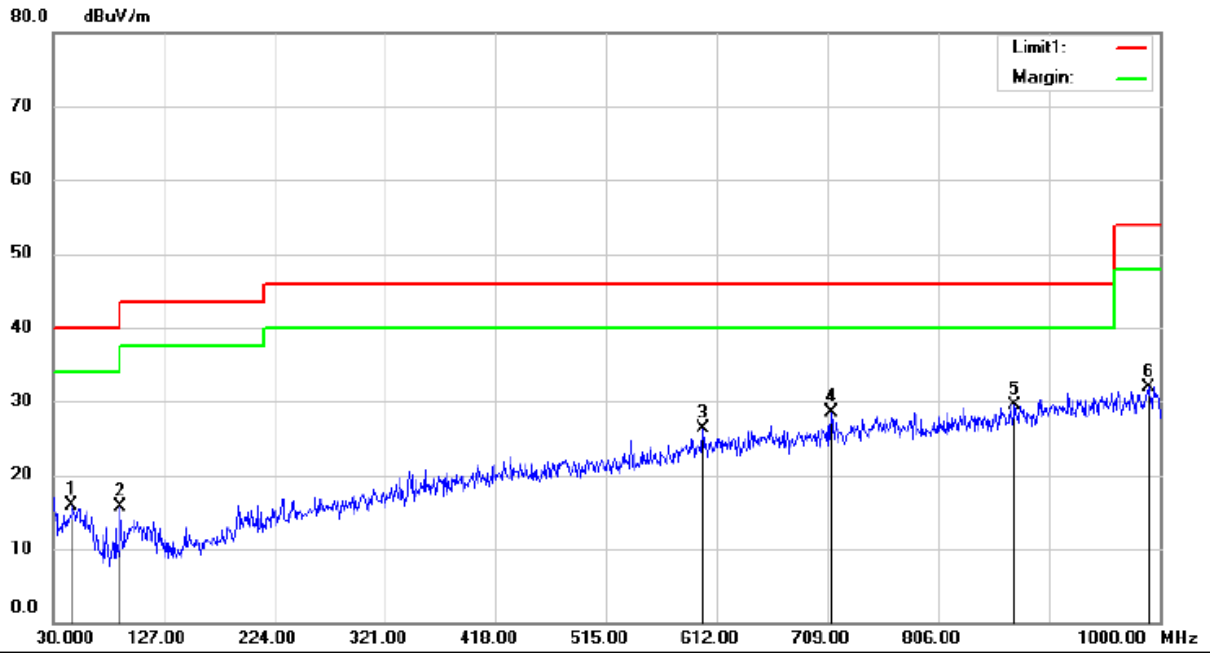

Site 3m Chamber 1# Polarization: **Vertical** Temperature: 27 C
 Limit: (RE)FCC PART 15 C Power: AC 120V/60Hz Humidity: 43 %
 Mode:TX2402MHz
 Note:

No.	Mk.	Freq. MHz	Reading Level dBuV	Correct Factor dB	Measure- ment dBuV/m	Limit dBuV/m	Over dB	Antenna Height cm	Table Degree degree	Detector	Comment
1		46.7324	27.12	-11.24	15.88	40.00	-24.12			QP	
2		90.0187	30.32	-14.61	15.71	43.50	-27.79			QP	
3		600.2387	28.37	-2.15	26.22	46.00	-19.78			QP	
4		712.3950	29.42	-0.83	28.59	46.00	-17.41			QP	
5	*	873.5362	28.05	1.50	29.55	46.00	-16.45			QP	
6		991.0275	28.19	3.79	31.98	54.00	-22.02			QP	

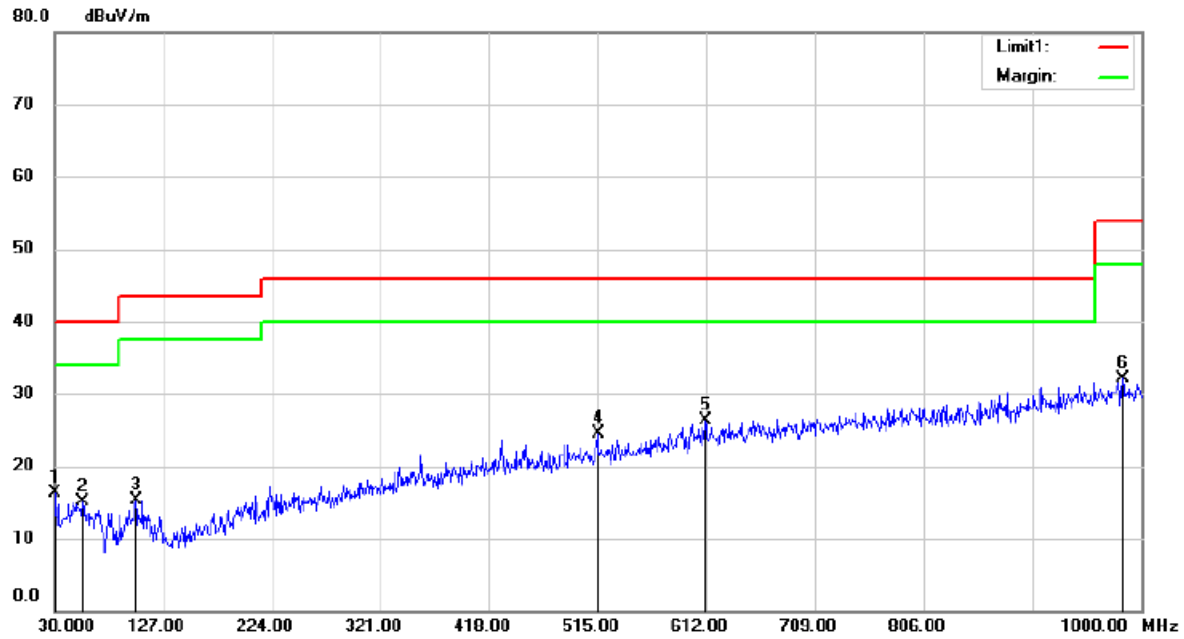

Site: 3m Chamber 1# Polarization: **Vertical** Temperature: 27 C
 Limit: (RE)FCC PART 15 C Power: AC 120V/60Hz Humidity: 43 %

Mode: TX2440MHz

Note:

No.	Mk.	Freq. MHz	Reading Level dBuV	Correct Factor dB	Measure- ment dBuV/m	Limit dBuV/m	Over dB	Detector	Antenna Height cm	Table Degree	Comment
1		30.2423	30.46	-14.13	16.33	40.00	-23.67	QP			
2		55.7050	26.97	-11.80	15.17	40.00	-24.83	QP			
3		102.9925	27.77	-12.41	15.36	43.50	-28.14	QP			
4		515.0000	28.95	-4.48	24.47	46.00	-21.53	QP			
5	*	611.6362	28.28	-2.01	26.27	46.00	-19.73	QP			
6		983.6312	28.55	3.61	32.16	54.00	-21.84	QP			

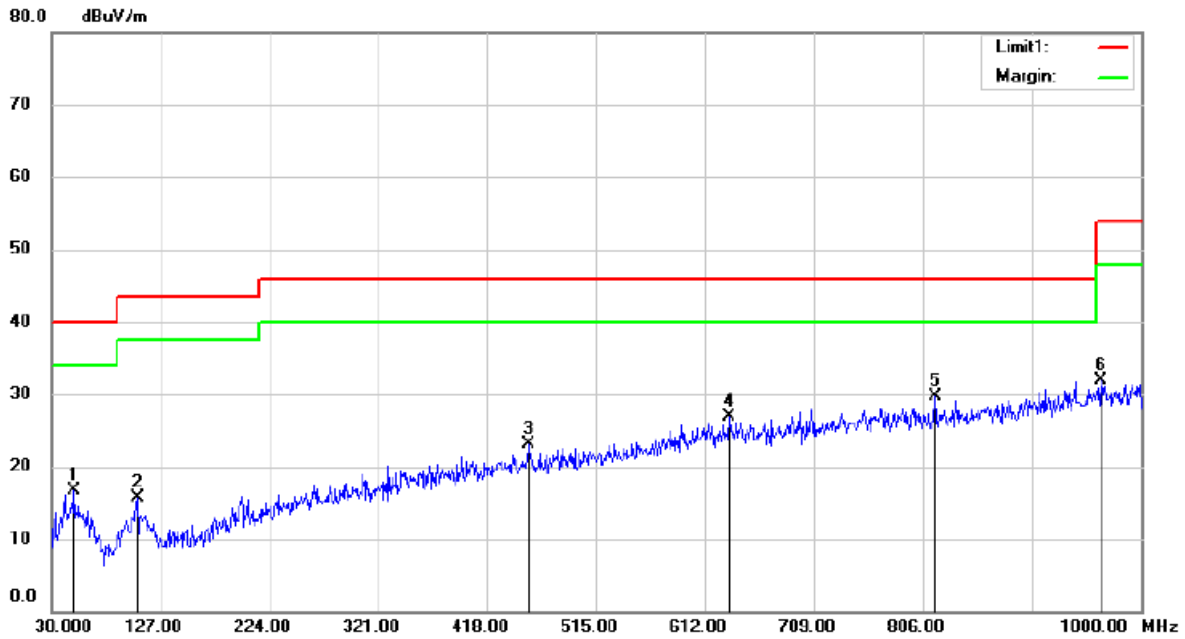

Site: 3m Chamber 1# Polarization: *Horizontal* Temperature: 27 C
 Limit: (RE)FCC PART 15 C Power: AC 120V/60Hz Humidity: 43 %

Mode: TX2440MHz

Note:

No.	Mk.	Freq. MHz	Reading Level dBuV	Correct Factor dB	Measure- ment dBuV/m	Limit dBuV/m	Over dB	Detector	Antenna Height cm	Table Degree	Comment
1		50.8550	27.93	-11.21	16.72	40.00	-23.28	QP			
2		107.2362	28.01	-12.40	15.61	43.50	-27.89	QP			
3		455.3450	28.50	-5.35	23.15	46.00	-22.85	QP			
4		633.8250	28.74	-1.83	26.91	46.00	-19.09	QP			
5	*	817.5187	29.24	0.43	29.67	46.00	-16.33	QP			
6		964.4737	28.67	3.23	31.90	54.00	-22.10	QP			

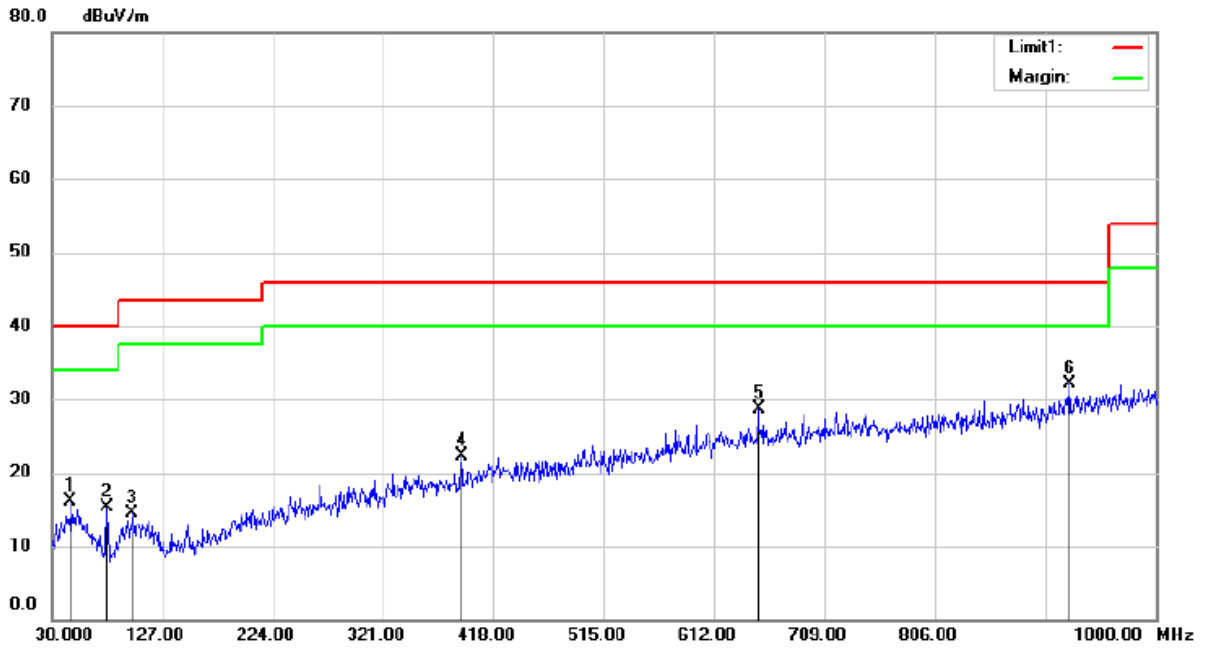

Site 3m Chamber 1#

Polarization: **Horizontal**

Temperature: 27 C

Limit: (RE)FCC PART 15 C

Power: AC 120V/60Hz

Humidity: 43 %

Mode: TX2480MHz

Note:

No.	Mk.	Freq.	Reading Level	Correct Factor	Measurement	Limit	Over	Antenna Height	Table Degree	
		MHz	dBuV	dB	dBuV/m	dBuV/m	dB	cm	degree	Comment
1		46.9750	27.25	-11.23	16.02	40.00	-23.98	QP		
2		79.1062	32.08	-16.87	15.21	40.00	-24.79	QP		
3		101.5374	26.97	-12.54	14.43	43.50	-29.07	QP		
4		389.8700	28.64	-6.35	22.29	46.00	-23.71	QP		
5		651.1637	30.41	-1.62	28.79	46.00	-17.21	QP		
6	*	924.4612	29.48	2.59	32.07	46.00	-13.93	QP		

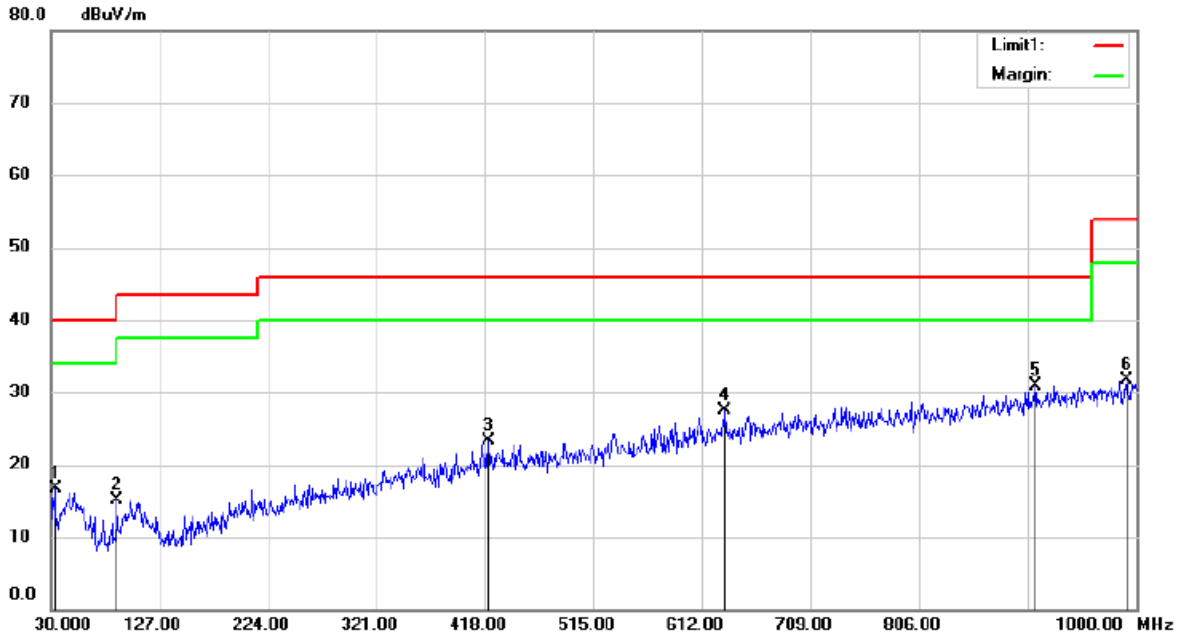

Site: 3m Chamber 1# Polarization: **Vertical** Temperature: 27 C
 Limit: (RE)FCC PART 15 C Power: AC 120V/60Hz Humidity: 43 %

Mode: TX2480MHz

Note:

No.	Mk.	Freq. MHz	Reading Level dBuV	Correct Factor dB	Measure- ment dBuV/m	Limit dBuV/m	Over dB	Detector	Antenna Height cm	Table Degree	Comment
1		34.6074	29.98	-13.20	16.78	40.00	-23.22	QP			
2		90.0186	29.76	-14.61	15.15	43.50	-28.35	QP			
3		421.6374	28.82	-5.55	23.27	46.00	-22.73	QP			
4		633.2187	29.39	-1.84	27.55	46.00	-18.45	QP			
5	*	910.6386	28.64	2.33	30.97	46.00	-15.03	QP			
6		991.8762	27.88	3.80	31.68	54.00	-22.32	QP			

8.6 CONDUCTED EMISSIONS TEST

8.6.1 Applicable Standard

According to FCC Part 15.207(a)

8.6.2 Conformance Limit

Frequency(MHz)	Conducted Emission Limit	
	Quasi-peak	Average
0.15-0.5	66-56	56-46
0.5-5.0	56	46
5.0-30.0	60	50

Note: 1. The lower limit shall apply at the transition frequencies
 2. The limit decreases in line with the logarithm of the frequency in the range of 0.15 to 0.50MHz.

8.6.3 Test Configuration

Test according to clause 7.3 conducted emission test setup

8.6.4 Test Procedure

The EUT was placed on a table which is 0.8m above ground plane.
 Maximum procedure was performed on the highest emissions to ensure EUT compliance.
 Repeat above procedures until all frequency measured were complete.

8.6.5 Test Results

Pass

The 120V &240V voltage have been tested, and the worst result recorded was report as below:

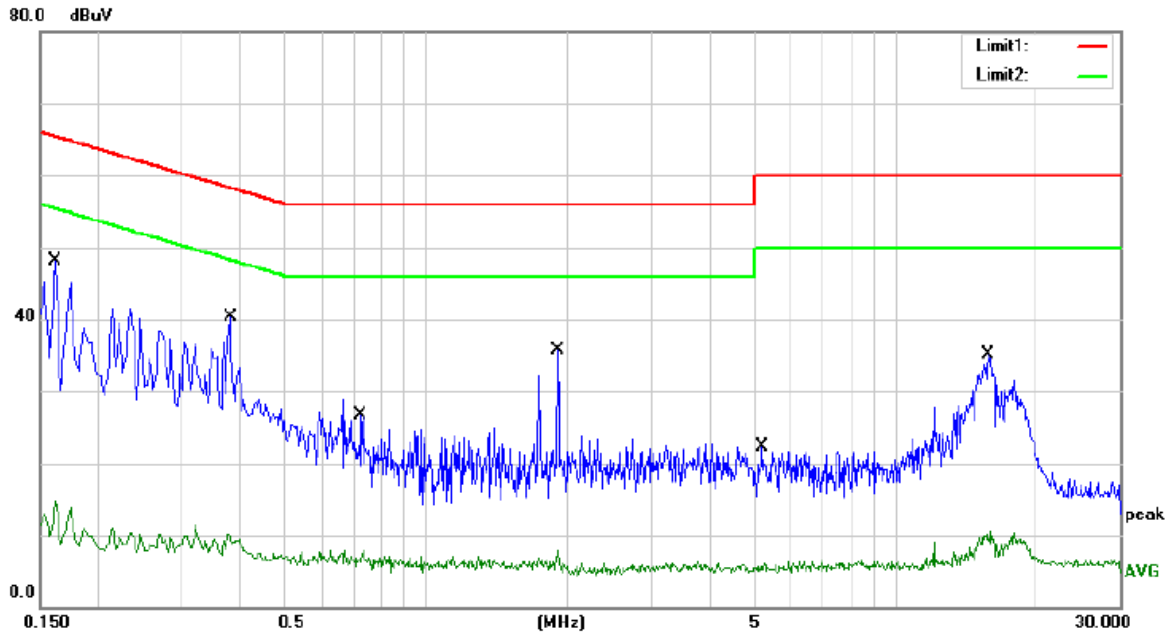

Site Conduction #1

Phase: **N**

Temperature: 24.9

Limit: (CE)FCC PART 15 class B_QP

Power: AC 120V/60Hz

Humidity: 54 %

Mode: TX

Note:

No.	Mk.	Freq. MHz	Reading Level dBuV	Correct Factor dB	Measure- ment dBuV	Limit dBuV	Over dB	Detector	Comment
1	*	0.1620	38.50	9.60	48.10	65.36	-17.26	QP	
2		0.1620	5.18	9.60	14.78	55.36	-40.58	AVG	
3		0.3820	30.65	9.57	40.22	58.24	-18.02	QP	
4		0.3820	1.39	9.57	10.96	48.24	-37.28	AVG	
5		0.7260	17.05	9.57	26.62	56.00	-29.38	QP	
6		0.7260	-1.60	9.57	7.97	46.00	-38.03	AVG	
7		1.9020	26.11	9.60	35.71	56.00	-20.29	QP	
8		1.9020	-1.78	9.60	7.82	46.00	-38.18	AVG	
9		5.2140	12.67	9.66	22.33	60.00	-37.67	QP	
10		5.2140	-3.30	9.66	6.36	50.00	-43.64	AVG	
11		15.7340	25.18	9.94	35.12	60.00	-24.88	QP	
12		15.7340	0.48	9.94	10.42	50.00	-39.58	AVG	

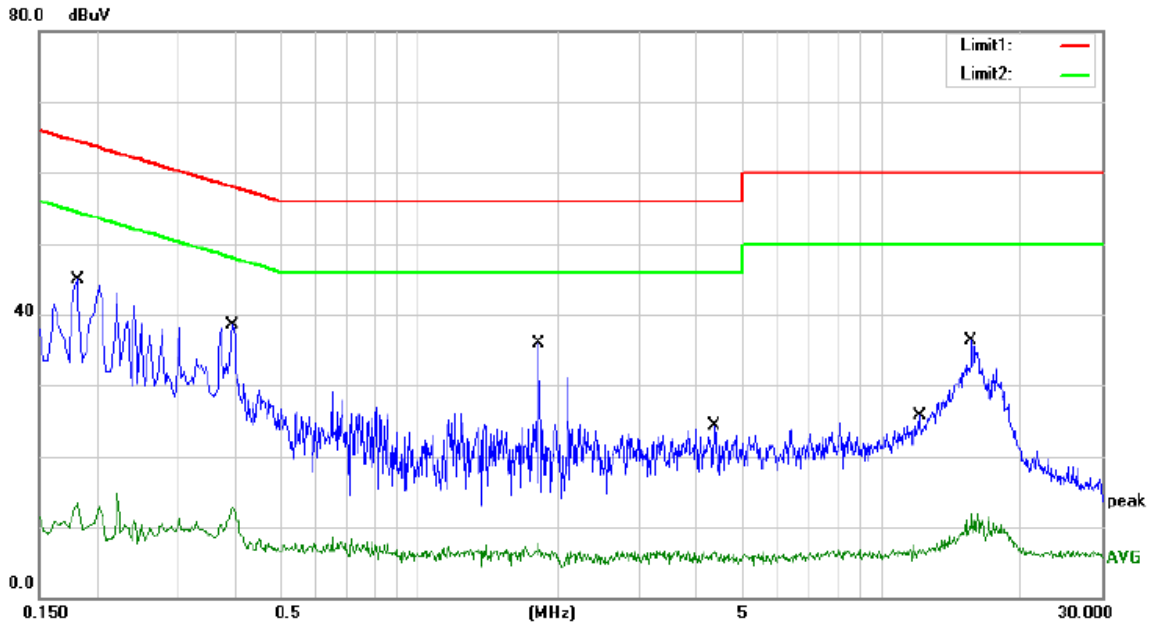

Site: Conduction #1 Phase: **L1** Temperature: 24.9
 Limit: (CE)FCC PART 15 class B_QP Power: AC 120V/60Hz Humidity: 54 %

Mode: TX
 Note:

No.	Mk.	Freq. MHz	Reading Level dBuV	Correct Factor dB	Measure- ment dBuV	Limit dBuV	Over dB	Detector	Comment
1		0.1820	35.26	9.55	44.81	64.39	-19.58	QP	
2		0.1820	5.08	9.55	14.63	54.39	-39.76	AVG	
3	*	0.3940	28.95	9.57	38.52	57.98	-19.46	QP	
4		0.3940	3.15	9.57	12.72	47.98	-35.26	AVG	
5		1.8140	26.29	9.60	35.89	56.00	-20.11	QP	
6		1.8140	-1.86	9.60	7.74	46.00	-38.26	AVG	
7		4.3580	14.72	9.65	24.37	56.00	-31.63	QP	
8		4.3580	-2.99	9.65	6.66	46.00	-39.34	AVG	
9		12.1220	15.79	9.83	25.62	60.00	-34.38	QP	
10		12.1220	-2.37	9.83	7.46	50.00	-42.54	AVG	
11		15.6660	26.35	9.93	36.28	60.00	-23.72	QP	
12		15.6660	1.96	9.93	11.89	50.00	-38.11	AVG	

8.7 ANTENNA APPLICATION

8.7.1 Antenna Requirement

Standard	Requirement
FCC CRF Part 15.203	An intentional radiator shall be designed to ensure that no antenna other than that furnished by the responsible party shall be used with the device. The use of a permanently attached antenna or of an antenna that uses a unique coupling to the intentional radiator shall be considered sufficient to comply with the provisions of this section. The manufacturer may design the unit so that a broken antenna can be replaced by the user, but the use of a standard antenna jack or electrical connector is prohibited. This requirement does not apply to carrier current devices or to devices operated under the provisions of §15.211, §15.213, §15.217, §15.219, or §15.221. Further, this requirement does not apply to intentional radiators that must be professionally installed, such as perimeter protection systems and some field disturbance sensors, or to other intentional radiators which, in accordance with §15.31(d), must be measured at the installation site. However, the installer shall be responsible for ensuring that the proper antenna is employed so that the limits in this part are not exceeded.

For intentional device, according to FCC 47 CFR Section 15.203, an intentional radiator shall be designed to ensure that no antenna other than that furnished by the responsible party shall be used with the device. And according to FCC 47 CFR Section 15.247 (b), if transmitting antennas of directional gain greater than 6dBi are used, the power shall be reduced by the amount in dB that the directional gain of the antenna exceeds 6dBi.

8.7.2 Result

PASS.

The EUT has 1 antenna: a Ceramic chip antenna for BT V4.0 with classic model, the gain is 0 dBi;

- Note:
- Antenna use a permanently attached antenna which is not replaceable.
 - Not using a standard antenna jack or electrical connector for antenna replacement
 - The antenna has to be professionally installed (please provide method of installation)

which in accordance to section 15.203, please refer to the internal photos.

Detail of factor for radiated emission

Frequency(MHz)	Ant_F(dB)	Cab_L(dB)	Preamp(dB)	Correct Factor(dB)
0.009	20.6	0.03	\	20.63
0.15	20.7	0.1	\	20.8
1	20.9	0.15	\	21.05
10	20.1	0.28	\	20.38
30	18.8	0.45	\	19.25
30	11.7	0.62	27.9	-15.58
100	12.5	1.02	27.8	-14.28
300	12.9	1.91	27.5	-12.69
600	19.2	2.92	27	-4.88
800	21.1	3.54	26.6	-1.96
1000	22.3	4.17	26.2	0.27
1000	25.6	1.76	41.4	-14.04
3000	28.9	3.27	43.2	-11.03
5000	31.1	4.2	44.6	-9.3
8000	36.2	5.95	44.7	-2.55
10000	38.4	6.3	43.9	0.8
12000	38.5	7.14	42.3	3.34
15000	40.2	8.15	41.4	6.95
18000	45.4	9.02	41.3	13.12
18000	37.9	1.81	47.9	-8.19
21000	37.9	1.95	48.7	-8.85
25000	39.3	2.01	42.8	-1.49
28000	39.6	2.16	46.0	-4.24
31000	41.2	2.24	44.5	-1.06
34000	41.5	2.29	46.6	-2.81
37000	43.8	2.30	46.4	-0.3
40000	43.2	2.50	42.2	3.5

----- END OF REPORT -----