

FCC Test Firm Designation Number: FR0014

Matériel testé :  
*Equipment under test:*

**WIZZILAB / WM205X**  
*(Trademark / Marketing name or product reference)*

Client / Demandeur:  
*Customer / Applicant :* **WIZZILAB SAS**  
29, boulevard Romain Rolland  
92120 MONTRouGE – France

Rapport délivré à :  
*Issued to:* **WIZZILAB SAS**  
*M. Yordan TABAKOV*  
29, boulevard Romain Rolland  
92120 MONTRouGE – France

Numéro d'affaire :  
*Work number :* 11522

Référence de la proposition :  
*Proposal number:* 012018-22879-1

Date de l'essai :  
*Date of test:* 13 et 14 décembre 2018  
*December 13<sup>th</sup> and 14<sup>th</sup>, 2018*

Objectif des essais :  
*Test purpose:* EMC qualification accordingly to following standards:  
- CFR 47, FCC Part 15, Subpart C  
*(Chapter 15.247 - Operation within the bands 902–928 MHz, 2400–2483.5 MHz, and 5725–5850 MHz)*  
- Industry Canada RSS-247, Issue 2  
*(Digital Transmission Systems Operating in the Bands 2400-2483.5 MHz)*

Lieu du test:  
*Test location:* SMEE, Rue de Taille  
38500 VOIRON - France

Test réalisé par :  
*Test realized by:* Laurent CHAPUS

Conclusion :  
*Conclusion:* L'équipement satisfait aux prescriptions des normes citées en référence.  
*The appliance complies with requirements of above mentioned standards.*

Ed.	Date	Modifications Pages /	Written by : Visa	Approved by: Visa
1	March 29 <sup>th</sup> , 2019	Initial Edition	Laurent Chapus	Régis ANCEL
2	May 15 <sup>th</sup> , 2019	TCB review (ATCB023799)		

La copie de ce document n'est permise que sous sa forme intégrale. Ce document est le résultat d'essais effectués sur un échantillon. Il ne préjuge pas de la conformité de l'ensemble des produits fabriqués à l'objet essayé.  
*This document shall not be reproduced, except in full. This document contains results related only to the item tested. It does not imply the conformity of the whole production to the item tested.*



Accréditation  
N° 1-6356  
Portée disponible sur :  
Scope available on :  
[www.cofrac.fr](http://www.cofrac.fr)

**COORDONNEES**

SMEE  
Rue de Taille – ZI Des Blanchisseries  
38500 VOIRON - France

TEL : 04 76 65 76 50  
FAX : 04 76 66 18 30

SAS au capital de 50 000 € / RC Grenoble B534 796 453 / SIRET 534 796 453 00015 / code APE 7490B / n° TVA : FR 59 534 796 453

**Contents**

1. NORMATIVES REFERENCES .....	3
2. TEST SYNTHESIS.....	4
3. EQUIPMENT UNDER TEST (EUT).....	5
4. TEST CONDITIONS.....	5
5. MODIFICATIONS OF THE EUT.....	6
6. SPECIAL ACCESSORY.....	6
7. MEASUREMENT UNCERTAINTY .....	6
8. FIELD STRENGTH CALCULATION.....	6
9. CONDUCTED EMISSION MEASUREMENT (150KHZ-30MHZ).....	7
10. CHANNEL SEPARATION.....	10
11. NUMBER OF HOPPING CHANNELS.....	16
12. AVERAGE TIME OF OCCUPANCY .....	18
13. FUNDAMENTAL EMISSION OUTPUT POWER.....	21
14. MAXIMUM POWER SPECTRAL DENSITY LEVEL IN THE FUNDAMENTAL EMISSION.....	25
15. UNWANTED SPURIOUS EMISSIONS (CONDUCTED EMISSIONS) .....	29
16. UNWANTED EMISSIONS IN NON-RESTRICTED FREQUENCY BANDS (RADIATED EMISSIONS).....	36
17. UNWANTED EMISSIONS IN RESTRICTED FREQUENCY BANDS.....	44
18. OCCUPIED BANDWIDTH (99%).....	57

**1. Normatives References**

FCC qualification according to:		
Standards	Applied	Title
ANSI C63.4 (2014)	X	American National Standard for Methods of Measurement of Radio-Noise Emissions from Low-Voltage Electrical and Electronic Equipment in the Range of 9 kHz to 40 GHz.
ANSI C63.10 (2013)	X	American National Standard for Testing Unlicensed Wireless Devices
CFR47, Part 15	X	Telecommunication – Federal Communication Commission – Radio frequency devices, Sections 15.109 / 15.209 / 15.247

ISED qualification according to:		
Standards	Applied	Title
ICES-003 (Issue 6/2016)	X	Information Technology Equipment (ITE) – Limits and methods of measurement
RSS-Gen (Issue 5/2018)	X	General Requirements and Information for the Certification of Radio Apparatus
RSS-247 (Issue2/2017)	X	Digital Transmission Systems (DTSs), Frequency Hopping Systems (FHSs) and Licence-Exempt Local Area Network (LE-LAN) Devices

**Note:** Following guidance are used

- DTS Measurement Guidance 558074 D01 v05
- Determining ERP and EIRP Guidance 412172 D01 v01r01

Deviation from standard: None

## 2. Test synthesis

### Requirement for Hybrid systems (DSS)

TEST	Paragraph number FCC Part 15 / IC RSS-247 / RSS-GEN	Spec. FCC Part 15 / IC RSS-247 / RSS-GEN	RESULTS  (comments)
Conducted emissions test	15.207 (a) RSS-Gen § 8.8	Table 15.107 (a) Table 4 / RSS-Gen	<b>PASS</b>
20dB Bandwidth	15.247 (a) (1) RSS-247 § 5.1	No requirements	<b>PASS</b>
Hopping channel separation	15.247 (a) (1) / RSS-247 5.1 a) b)	<u>Minimum separation</u> 25kHz or the two-third 20dB bandwidth whichever is greater	<b>PASS</b>
Number of hopping frequencies	15.247 (a) (1) / RSS-247 5.1 c)	No requirements for hybrid systems	<b>PASS</b>
Time of occupancy	15.247 (f) / RSS-247 5.3 a)	Maximum 400ms per channel within 3.2s (8 channels used)	<b>PASS</b>
Maximum Conducted Output Power	15.247 (b) (3) RSS-247 § 5.4 (d)	1W max / 30dBm (Conducted) 4W max / 36dBm (EIRP)	<b>PASS</b>
Maximum Power Spectral Density	15.247 (e) RSS-247 § 5.2 (b)	8dBm in a 3kHz band segment	<b>PASS</b>
Unwanted emissions into Non Restricted Frequency Bands	15.247 (d) / RSS-247 § 5.5	-30dBc in any 100kHz outside frequency band.	<b>PASS</b>
Unwanted emissions into Restricted Frequency Bands	15.209 (a) / 15.247 (d) / 15.205 (a) RSS-GEN § 7.1, §8.9, § 8.10 / RSS-247 § 5.5	<u>Measure at 300m</u> 9-490kHz: 2400µV/m/F(kHz) <u>Measure at 30m</u> 0.490-1.705: 24000µV/m/F(kHz) 1.705-30MHz: 30µV/m <u>Measure at 3m</u> 30MHz-88MHz : 40 dBµV/m 88MHz-216MHz : 43.5 dBµV/m 216MHz-960MHz : 46.0 dBµV/m Above 960MHz : 54.0 dBµV/m	<b>PASS</b>
Occupied Bandwidth	RSS-GEN § 6.7	BW at 99%	<b>PASS</b>

- General conclusion:**

Measures and tests performed on the sample of the product **WIZZILAB / WM205X**, in configuration and description presented in this test report, show compliance with standards FCC CFR 47, PART 15, Subpart C and ISED RSS-Gen & RSS-247.

### 3. Equipment Under Test (EUT)

**Nom /  
Identification**

**WIZZILAB / WM205X**  
(Trademark / Marketing name or product reference)

Sn: 001BC50C70000F88  
& 001BC50C70000F93

**FCC ID:  
Model:**

FCC ID: 2ARZVWM  
HVIN: WM205X

**Alimentation /  
Power supply**

3V DC (RF module via test board)

**Auxiliaires /  
Auxiliaries**

- Battery pack 3V  
- DC power supply GOODWILL PPT3615G (ALI-101-005)

**Entrées-Sorties /  
Input / Output**

	Câbles pour essai / Cables for test	Blindé / Shielded	Prévu pour >3m / Intended for >3m
3V DC power input	2 wires, 0.3m	No	No

**Version programme /  
Firmware version**

N.C

**Mode de fonctionnement /  
Running mode**

The tested sample is able to:

- Transmit a continuous (100% duty cycle) carrier frequency on low, and high channels with all modulation schemes (LORA and FSK) on lower band (B1) and higher band (B2)
- Be in normal timing operation mode (hybrid mode) on lower or upper bands with LORA (SF is taken at 10 as worst case) or FSK modulation

**Programme de test /  
Test program /**

None

**Fréquence max interne EST /  
Max internal EUT frequency**

25MHz (Except RF frequency)

**Information sur l'équipement /  
Equipment information**

- Frequency band: 902 to 928MHz (Tx & Rx)
- Operating channel: Lower band B1: 903.9 / 904.1 / 904.3 / 904.5 / 904.7 / 904.9 / 905.1 / 905.3 MHz  
Lower band B2: 906.9 / 907.1 / 907.3 / 907.5 / 907.7 / 907.9 / 908.1 / 908.3 MHz
- Modulation: MOD1: LORA (125kHz / SF 6 to 10)  
MOD2: FSK (1.8bpsk / 55kbps)
- Rated peak output power: 13dBm
- Channel spacing for hybrid mode: 200kHz
- Antenna #1: 1/4 Wave Antenna with maximum gain -1.3dBi (LINX / ANT-916-CW-RH)
- Antenna #2: 1/2 Wave Antenna with maximum gain 2.2dBi (LINX / ANT-916-OC-LG)
- Module powered by 3V DC from test board

### 4. Test conditions

Power supply voltage:

Equipment under test:

Auxiliaries:

3V DC  
110V/60Hz (Conducted emission)

## 5. Modifications of the EUT

None

## 6. Special accessory

None

## 7. Measurement Uncertainty

Test Description	Expanded uncertainty
Conducted emissions test (150k-30MHz, AC mains)	± 3.5dB
Radiated emission test (9kHz-30MHz, electric field)	± 4.0dB
Radiated emission test (30-300MHz, OATS)	± 5.6dB
Radiated emission test (300-1000MHz, OATS)	± 5.3dB
Radiated emission test (1-40GHz, OATS / FAC)	± 5.6dB
Conducted RF output power at antenna port	± 1.6dB
Radiated RF output power (Peak, Power density)	± 5.6dB
DTS Bandwidth, 99% OBW	±4%
Temperature	± 1°C
Time and duty cycle calculation	±1%
AC and DC voltage	±1%

Note: Expanded uncertainty at 95% confidence (k=2)

## 8. Field Strength Calculation

The field strength (level) is calculated by adding the Antenna Factor and Cable Factor, and subtracting the Amplifier Gain (if any) from the measured reading. The basic equation is as follow:

$$FS = RA + AF + CF - AG$$

Where FS = Field Strength (Level)

RA = Receiver Amplitude (Meter Reading)

AF = Antenna Factor

CF = Cable Factor

AG = Amplifier Gain

Margin value = Emission level – Limit value

Example:

RA: 14.0dBμV / AF: 16.5 dBm<sup>-1</sup> / CF: 3.5dB / AG: 15dB

→ Total factor: 5dBm<sup>-1</sup>

→ Field level: 19.0dBμV/m (-21.0dB for margin if limit is 40dBμV/m)

**9. Conducted Emission Measurement (150kHz-30MHz)**

TEST: Limits for conducted disturbance 150kHz – 30MHz				Verdict	
<p><b>Method:</b> The LISN is placed 0,8 m from the boundary of the unit under test and bonded to a ground reference plane. This distance was between the closest points of the AMN and the EUT. All other units of the EUT and associated equipment were at least 0,8 m from the AMN. All power was connected to the system through Artificial Mains Network (AMN). Conducted voltage measurements on lines were made at the output of the LISN. The EUT is 80cm above the ground reference plane and 40cm from the vertical ground plane. The AC power cable is 1m length.</p>				<b>Pass</b>	
Laboratory Parameters:		Required prior to the test		During the test	
Ambient Temperature		20 to 30 °C		22°C ± 2	
Relative Humidity		25 to 70 %		35% ± 5	
Fully configured sample scanned over the following frequency range		Frequency range on each side of line		Measurement Point	
		150kHz to 30MHz		AC input port (110V)	
Limits					
Frequency (MHz)	Limit dB (µV)				
	Quasi-Peak	Result	Average	Result	
0.15 – 0.50	66 \ 56	<b>PASS</b>	56 \ 46	<b>PASS</b>	
0.50 - 5	56	<b>PASS</b>	46	<b>PASS</b>	
5 – 30	60	<b>PASS</b>	50	<b>PASS</b>	
Supplementary information:					
Test location: SMEE					
Test date: December 14 <sup>th</sup> , 2018. Tested by L. CHAPUS					
Power supply voltage: AC mains 110V/60Hz					

Test Equipment Used					
Description	Manufacturer	Model	Identifier	Cal. Date	Cal. Due
Attenuator / limiter	SMEE	ATT#2	ATT-171-010	2018/6	2019/6
Cable RF	Div	1m	CAB-101-021	2018/4	2019/4
LISN (50Ω / 50µH) (Meas.)	AFJ	LS16C	RSI-101-001	2017/6	2019/6
Measuring receiver	Rohde&Schwarz	ESRP	REC-151-002	2017/5	2019/5
EMC Software	NEXIO	BAT EMC V3.8	SOF-101-001	-	-
AC power supply	PACIFIC POWER	AMX-125	ALI-101-002	-	-
DC power supply	GOODWILL	PPT3615G	ALI-101-005	-	-
Multimeter	FLUKE	287	MUL-131-005	2017/7	2019/7

## Test Setup for conducted emission

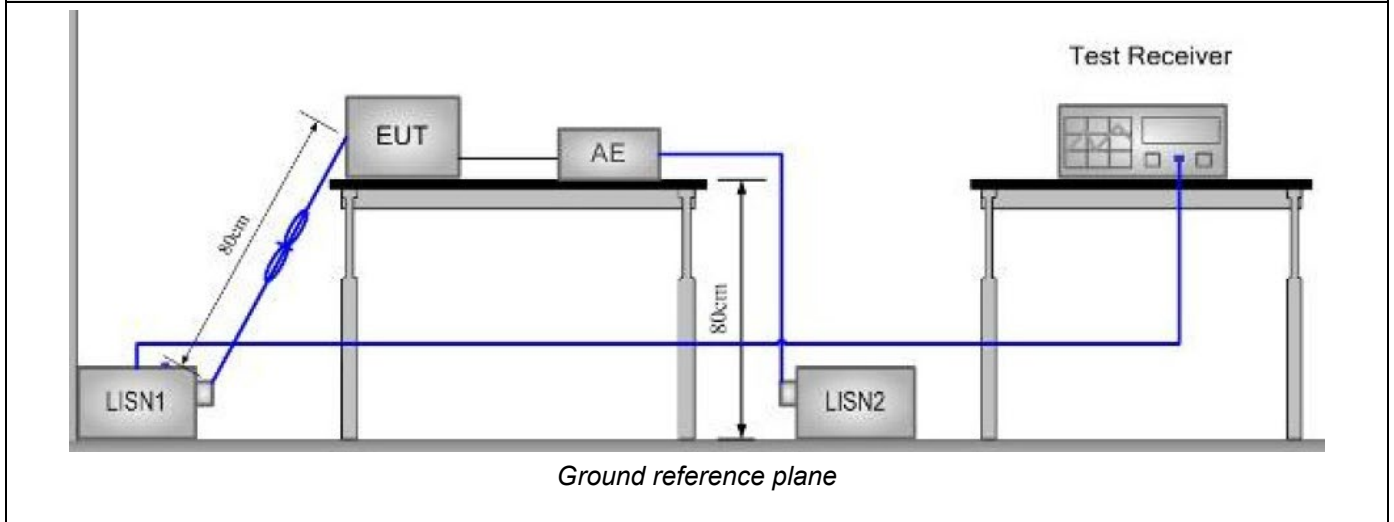

### Tabulated Results for Mains Terminal Disturbance Voltage on AC port

FREQ (MHz)	Meas. PK (dB $\mu$ V)	Mes. QP (dB $\mu$ V)	LIMIT QP (dB $\mu$ V)	Margin QP (dB)	Mes. AV (dB $\mu$ V)	LIMIT AV (dB $\mu$ V)	Margin AV (dB)	Line
0.1770	47.0	42.0	64.6	-22.6	41.1	54.6	-13.5	L1
0.1795	47.5	43.2	64.6	-21.4	42.5	54.6	-12.1	N
<b>RBW:</b>	9kHz							
<b>Voltage:</b>	110V/60Hz							
<b>Limit:</b>	FCC Part 15.209 a) / RSS-Gen: Issue 5, §8.8 Table 4							
<b>Final measurement detector:</b>	Quasi-Peak and CISPR Average (AV)							
<b>RESULT:</b>	PASS							
<b>Measured value calculation:</b>	<p>The measured value (level) is calculated by adding the Cable Factor, the Transient suppressor attenuation and LISN attenuation from the receiver amplitude reading. The basic equation is as follow:</p> $\text{Meas.} = \text{RA} + \text{CF} + \text{ATT}_{\text{TRAN}} + \text{ATT}_{\text{LISN}}$ <p>Where</p> <ul style="list-style-type: none"> <li>Meas. = Level (dB<math>\mu</math>V)</li> <li>RA = Receiver Amplitude</li> <li>CF = Cable Factor</li> <li>ATT<sub>TRAN</sub> = Transient suppressor attenuation</li> <li>ATT<sub>LISN</sub> = LISN attenuation</li> </ul> <p>Margin value = Emission level – Limit value (A negative margin shows compliance to limit)</p>							



## Graphical representation of Conducted Disturbance Measurement (Peak and Average detection) AC port, Line L1

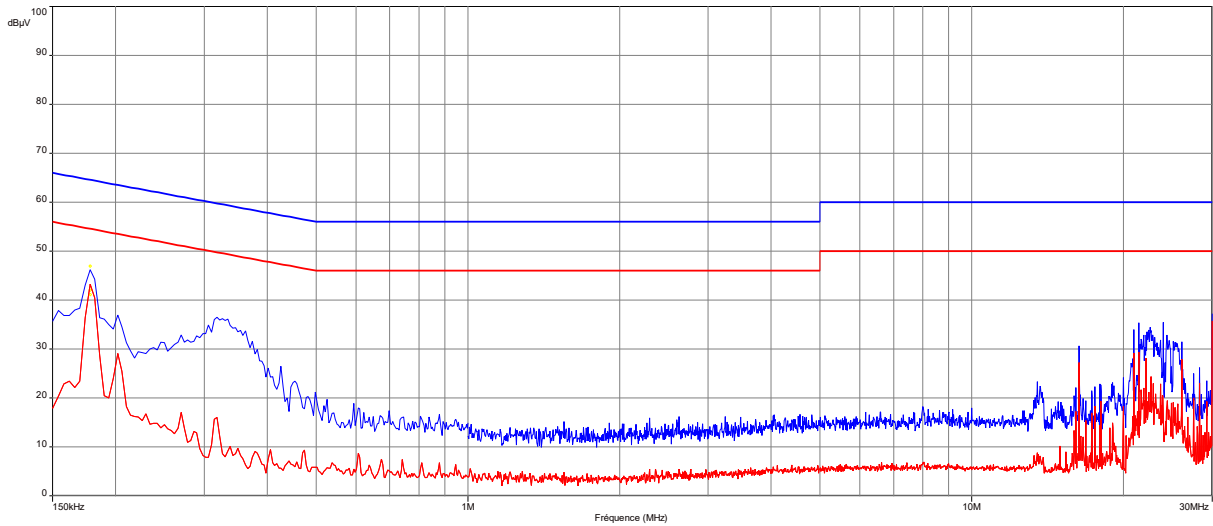

Note : Same result for all transmit modes on all channels.

----: Peak

----: Average

## Graphical representation of Conducted Disturbance Measurement (Peak and Average detection) AC port, Line Neutral

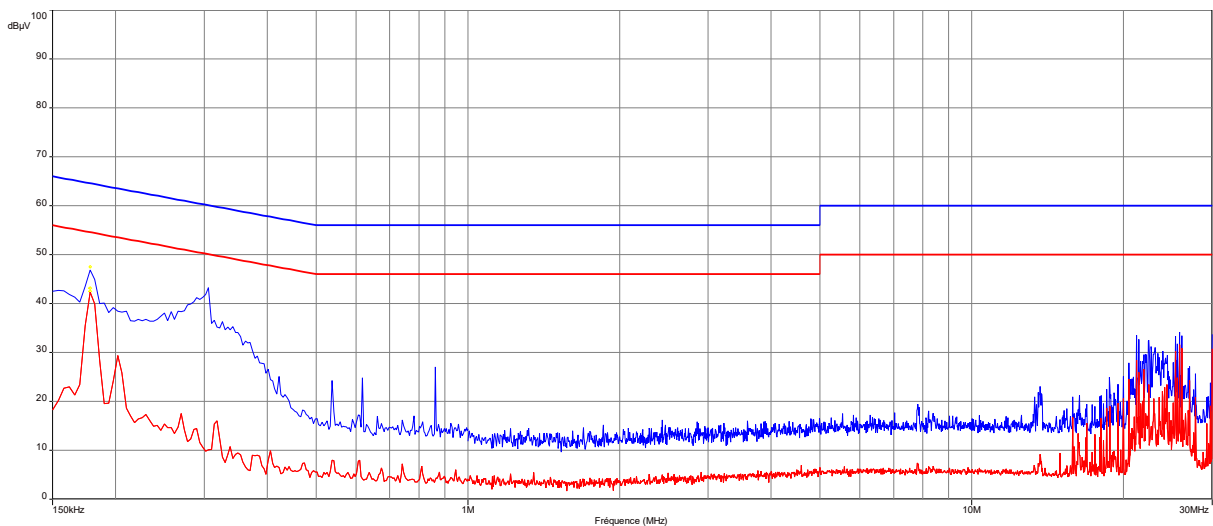

Note : Same result for all transmit modes on all channels.

----: Peak

----: Average

**10. Channel Separation**

<b>TEST: Hopping channel measurement (Separation)</b>			<b>Verdict</b>
<p><b>Method:</b> The Equipment under test is connected to the measuring receiver with suitable mean.            The SPAN is adapted to see the frequency band of operation. The spectrum analyzer RBW was 100kHz and VBW was 100kHz.            The channel separation is measured with the hopping function enable on the EUT.  <b>Limits:</b> Minimum separation between channels shall be 25kHz or the two-third 20dB bandwidth, whichever is greater.</p>			<b>Pass</b>
<b>Laboratory Parameters:</b>	<b>Required prior to the test</b>	<b>During the test</b>	
Ambient Temperature	20 to 30 °C	22°C ± 2	
Relative Humidity	25 to 70 %	35% ± 5	
<p>Supplementary information:            Test location: SMEE.            Test date: December 13<sup>th</sup>, 2018. Tested by L. CHAPUS</p>			

<b>Test Equipment Used</b>					
Description	Manufacturer	Model	Identifier	Cal. Date	Cal. Due
Attenuator	Mini-Circuit	BW-N10W5+	ATT-171-008	2018/4	2019/4
Spectrum analyzer	Rohde&Schwarz	FSV40	ASP-171-004	2017/5	2019/5

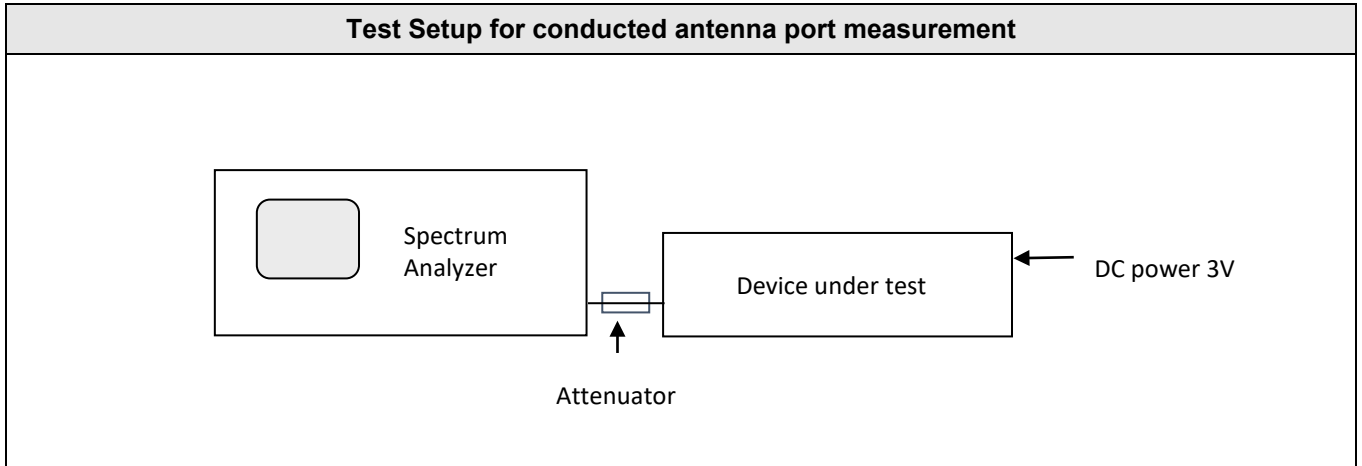

Tabulated Results for Hopping Channel Separation (Hybrid mode)				
Channel frequency	Adjacent channel separation	20dB Bandwidth	Minimum limit	Result
(MHz)	(kHz)	(kHz)	(kHz)	
903.9 / LORA-B1	<b>200.0</b>	138.00	92.000	PASS
905.3 / LORA-B1		138.00	92.000	PASS
906.9 / LORA-B2		137.75	91.833	PASS
908.3 / LORA-B2		137.70	91.800	PASS
903.9 / FSK-B1	<b>199.3</b>	178.85	119.233	PASS
905.3 / FSK-B1		178.85	119.233	PASS
906.9 / FSK-B2		179.05	119.367	PASS
908.3 / FSK-B2		178.20	118.800	PASS

## Graphical representation of 20dB Bandwidth & Hopping channel separation LORA/B1

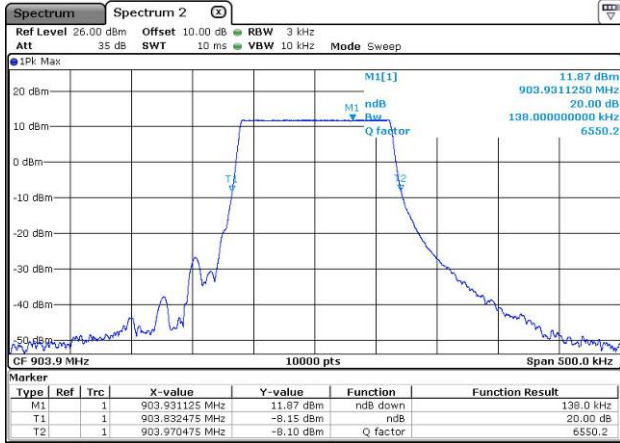

Low channel

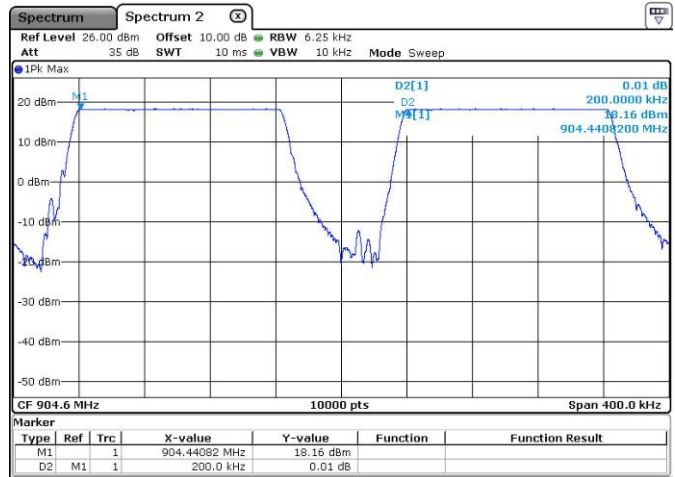

Channel separation

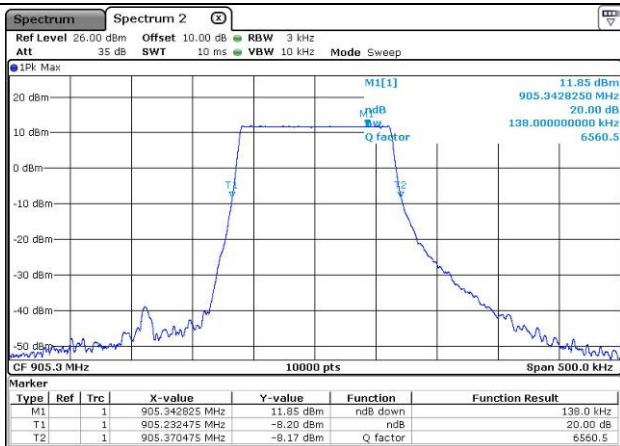

High channel

## Graphical representation of 20dB Bandwidth & Hopping channel separation LORA/B2

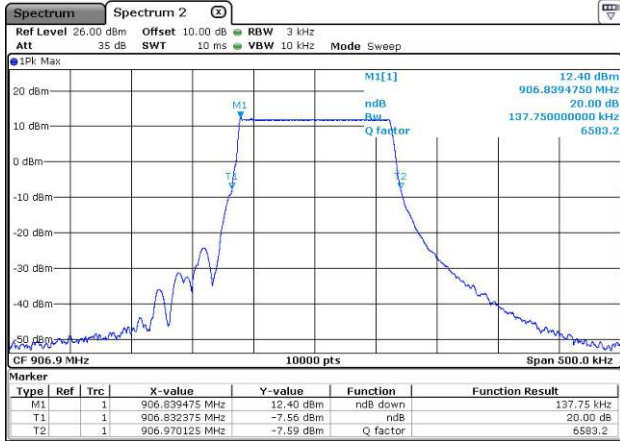

Low channel

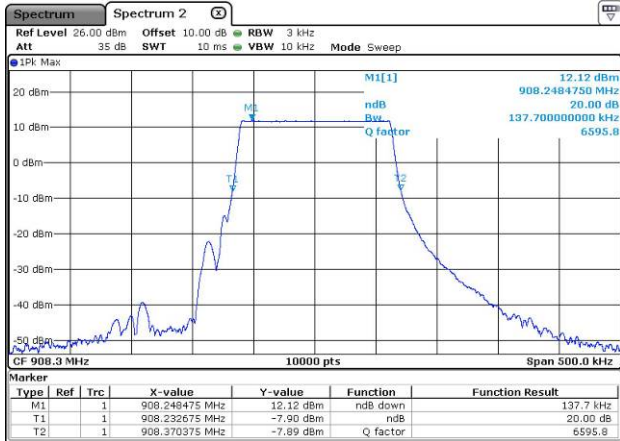

High channel

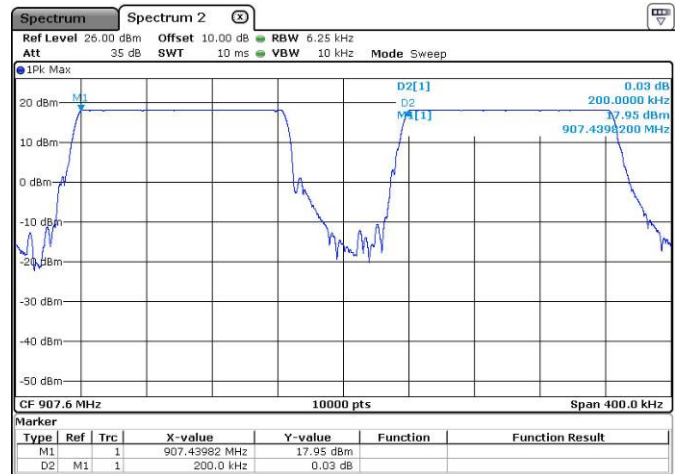

Channel separation

## Graphical representation of 20dB Bandwidth & Hopping channel separation FSK/B1

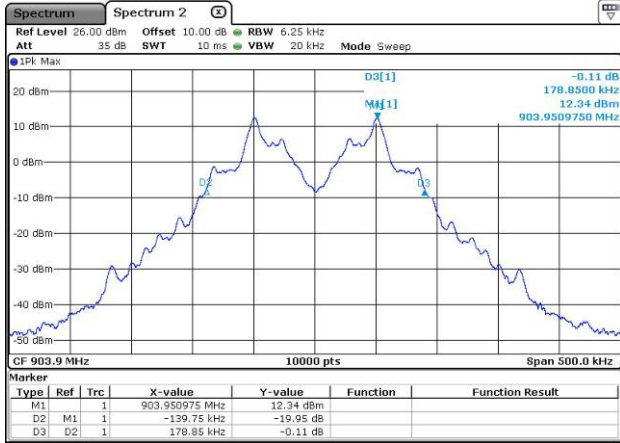

Low channel

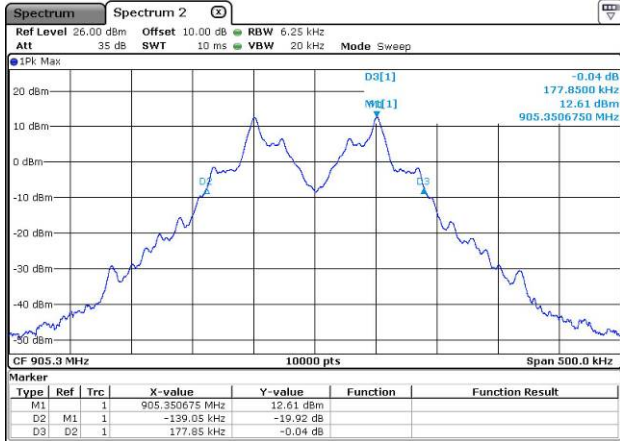

High channel

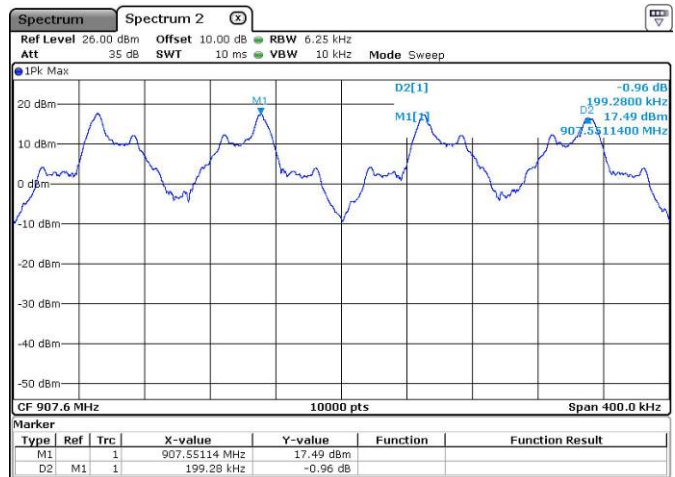

Channel separation

## Graphical representation of 20dB Bandwidth & Hopping channel separation FSK/B2

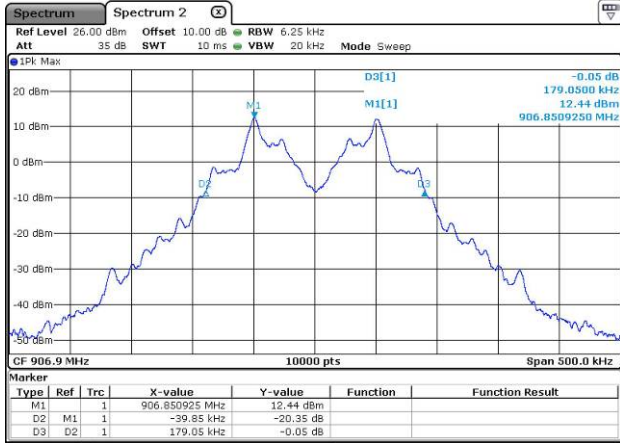

Low channel

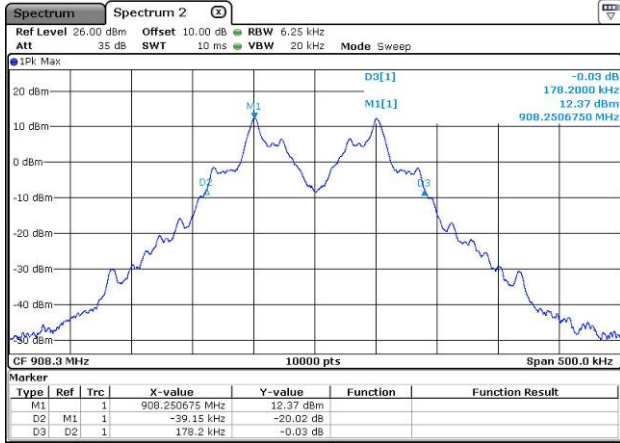

High channel

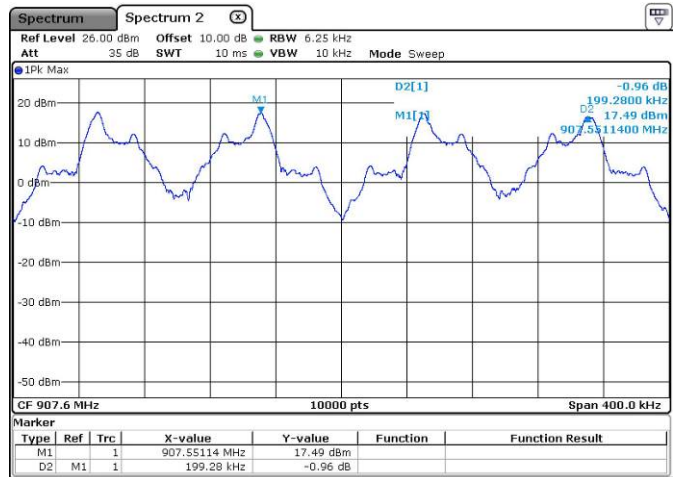

Channel separation

**11. Number of hopping channels**

TEST: Number of hopping channels		Verdict					
<p>Method: The Equipment under test is connected to the measuring receiver with suitable mean.            The SPAN is adapted to see the frequency band of operation. The spectrum analyzer RBW was 10kHz and VBW was 100kHz.            The EUT has its hopping function enable.            Limits: At least 15 channels frequencies shall be used and equally spaced, in the band 2400-2483MHz.</p>		<b>Pass</b>					
Laboratory Parameters:	<table border="1"> <thead> <tr> <th>Required prior to the test</th> <th>During the test</th> </tr> </thead> <tbody> <tr> <td>Ambient Temperature</td> <td>20 to 30 °C</td> </tr> <tr> <td>Relative Humidity</td> <td>25 to 70 %</td> </tr> </tbody> </table>		Required prior to the test	During the test	Ambient Temperature	20 to 30 °C	Relative Humidity
Required prior to the test	During the test						
Ambient Temperature	20 to 30 °C						
Relative Humidity	25 to 70 %						
<p>Supplementary information:            Test location: SMEE.            Test date: December 13<sup>th</sup>, 2018. Tested by L. CHAPUS</p>							

Test Equipment Used					
Description	Manufacturer	Model	Identifier	Cal. Date	Cal. Due
Attenuator	Mini-Circuit	BW-N10W5+	ATT-171-008	2018/4	2019/4
Spectrum analyzer	Rohde&Schwarz	FSV40	ASP-171-004	2017/5	2019/5

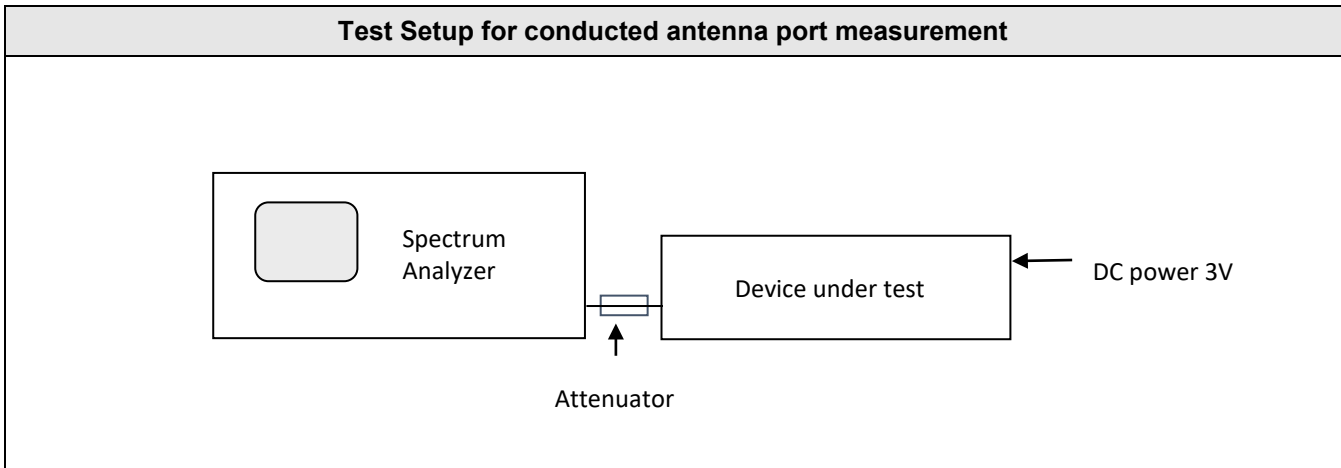



## Tabulated Results for Number of Hopping Channel

Number of channels	Minimum number of channels	Result
8	-	PASS

## Graphical representation for Number of Hopping Channel

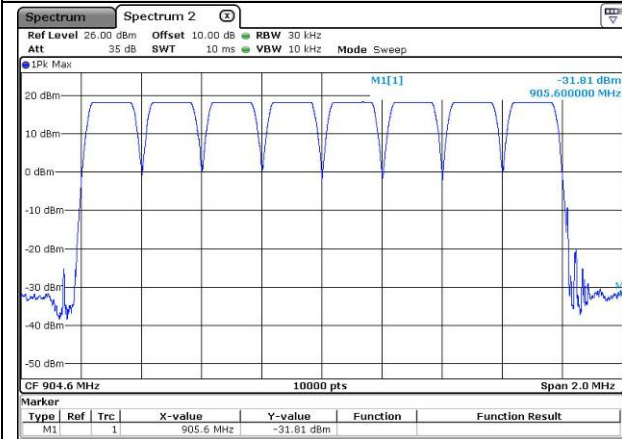

LORA / B1

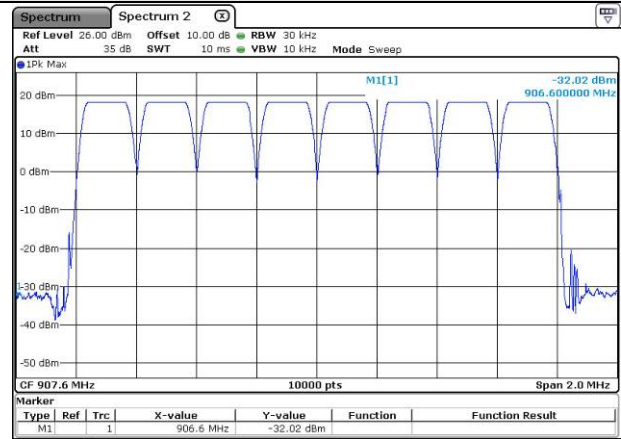

LORA / B2

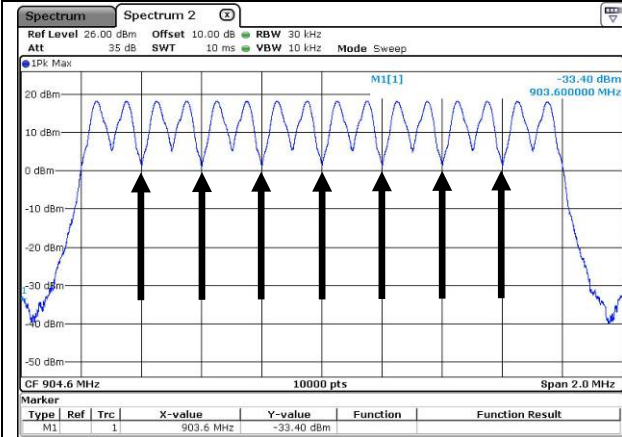

FSK / B1

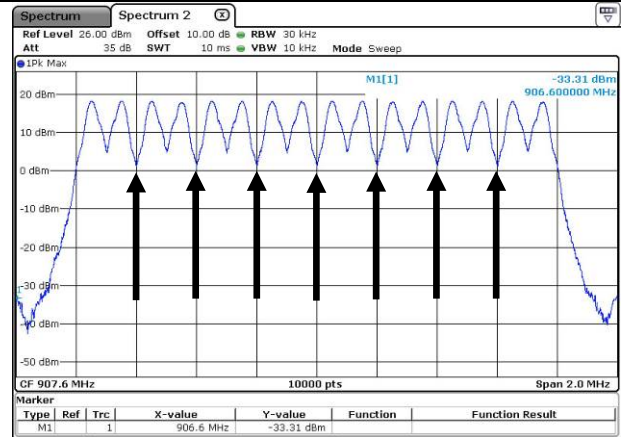

FSK / B1

## 12. Average Time of occupancy

TEST: Time of occupancy		Verdict
Method: The Equipment under test is connected to the measuring receiver with suitable mean. The spectrum analyser is set to zero-span. The EUT has its hopping function enable. Limits: 400ms of transmission by channel on a period 3.2s. (8 channels used)		<b>Pass</b>
Laboratory Parameters:	Required prior to the test	During the test
Ambient Temperature	20 to 30 °C	22°C ± 2
Relative Humidity	25 to 70 %	35% ± 5
Supplementary information: Test location: SMEE. Test date: December 13 <sup>th</sup> , 2018. Tested by L. CHAPUS		

Test Equipment Used					
Description	Manufacturer	Model	Identifier	Cal. Date	Cal. Due
Attenuator	Mini-Circuit	BW-N10W5+	ATT-171-008	2018/4	2019/4
Spectrum analyzer	Rohde&Schwarz	FSV40	ASP-171-004	2017/5	2019/5

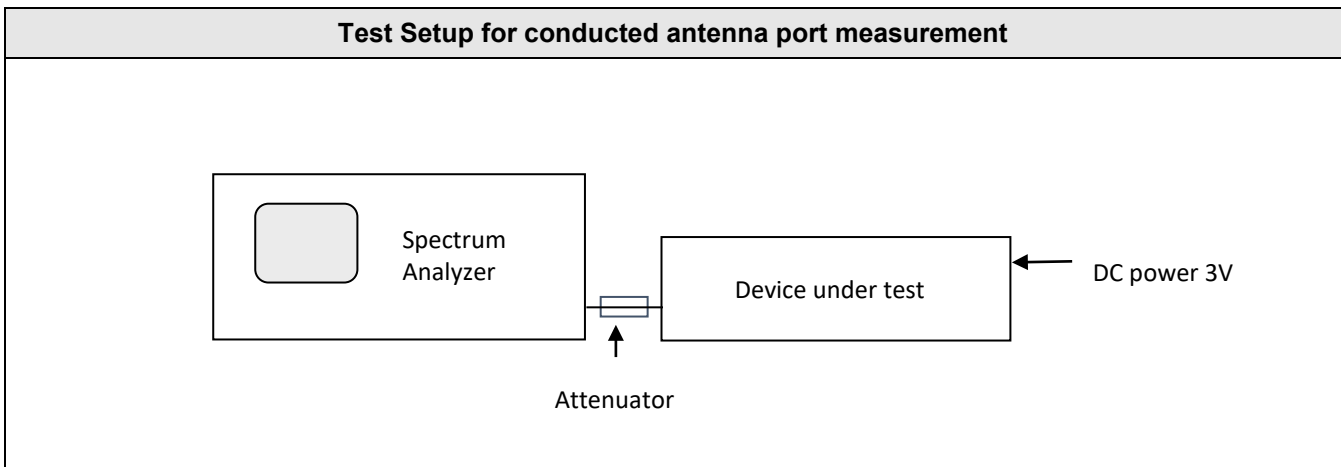

### Tabulated Results for Dwell time

Modulation	Number of pulses per 3.2s period (1)	Length of 1 pulse (ms)	Average Time of occupancy (ms)	Limit (ms)	Result
LORA	1	346.01	346.01	400ms	PASS
FSK	6	66.00	396.00	400ms	PASS

Additional information:

(1): Period of 3.2s (0.4s x 8 channels)

### Graphical representation for dwell time (LORA B1 & B2)

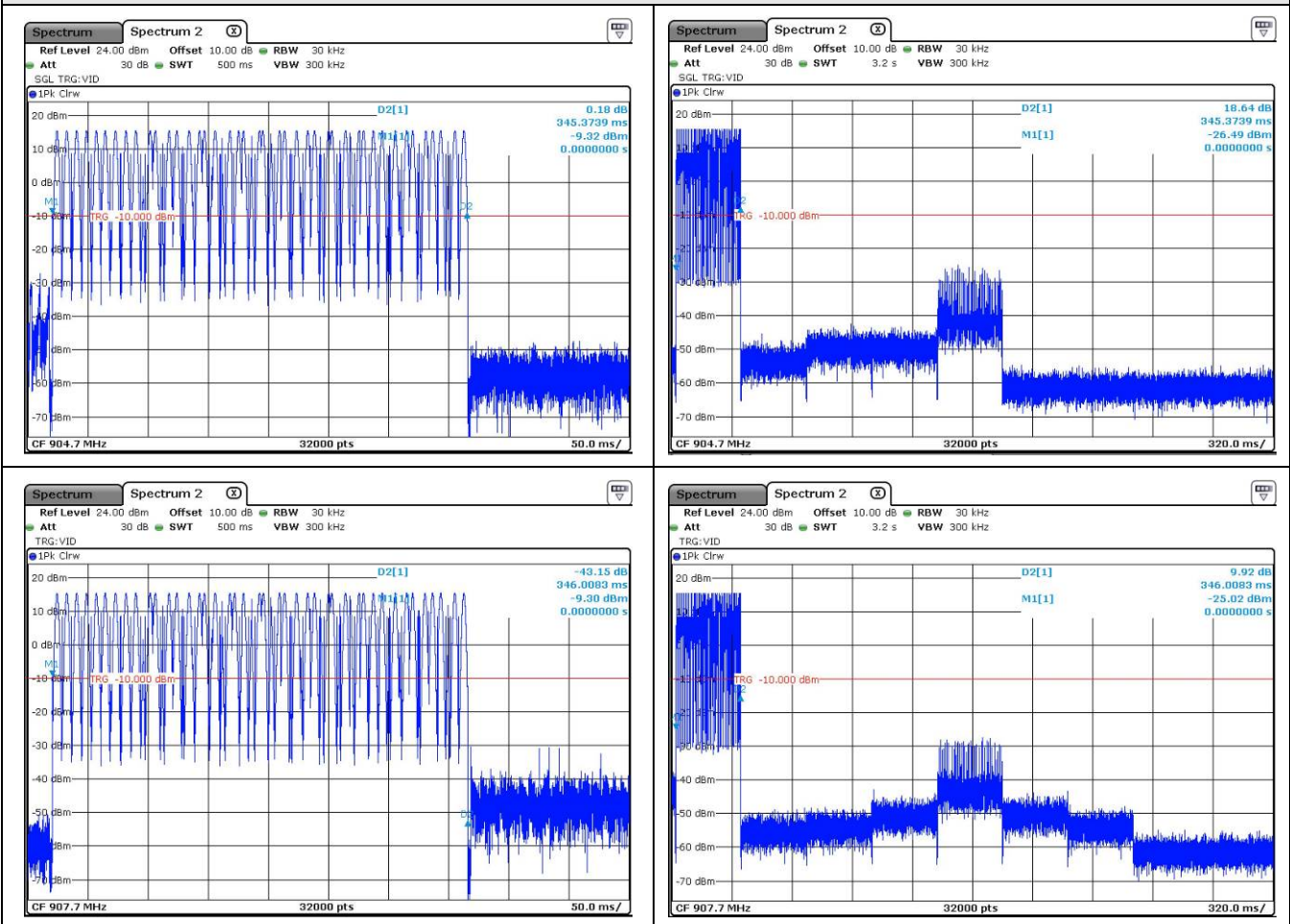

## Graphical representation for dwell time (FSK B1 & B2)

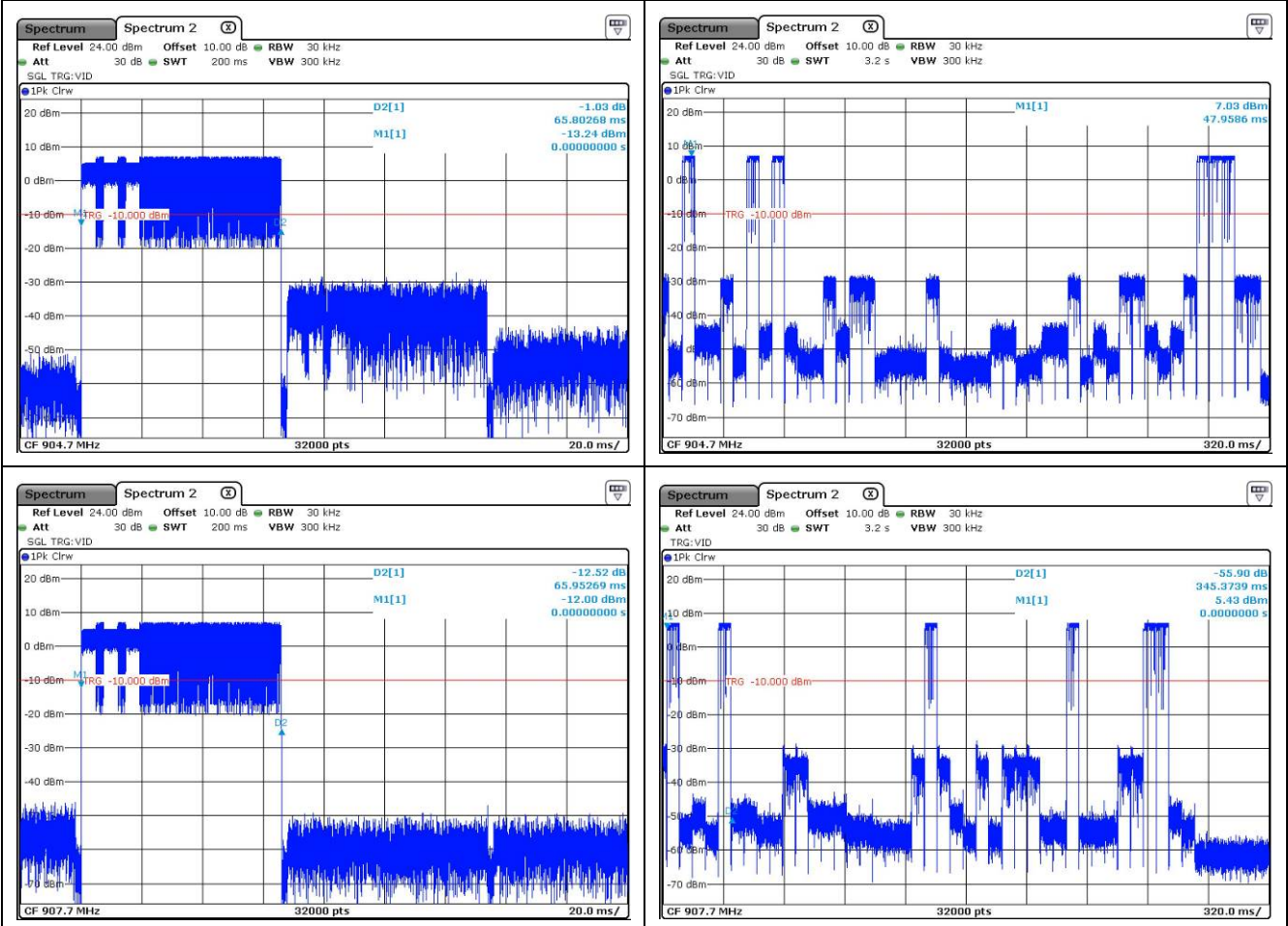

**13. Fundamental emission output power**

<b>TEST: Maximum conducted output power</b>		<b>Verdict</b>
<p><u>Method:</u> The setup is in an anechoic chamber. The spectrum analyzer is connected to the antenna port of the device under test. A conducted measurement is performed. The tested equipment is set to transmit operation with modulation on low and high channels.</p>		<b>Pass</b>
Laboratory Parameters:	Required prior to the test	During the test
Ambient Temperature	10 to 40 °C	22°C ± 2
Relative Humidity	10 to 90 %	35% ± 5
<b>Limits – FCC Part 15.247 (b) / RSS-247 §5.4</b>		
Frequency (MHz)	Limits	
	Level	Results
903.9 to 905.3 (LORA / FSK)	30 dBm (Conducted) 36 dBm (Radiated, EIRP)	<b>Pass</b>
906.9 to 908.3 (LORA / FSK)		<b>Pass</b>
<p>Supplementary information:          Test location: SMEE.          Test date: December 13<sup>th</sup>, 2018. Tested by L. CHAPUS</p>		

Test Equipment Used					
Description	Manufacturer	Model	Identifier	Cal. Date	Cal. Due
Attenuator	Mini-Circuit	BW-N10W5+	ATT-171-008	2018/4	2019/4
Measuring receiver	Rohde&Schwarz	ESRP	REC-151-003	2017/5	2019/5

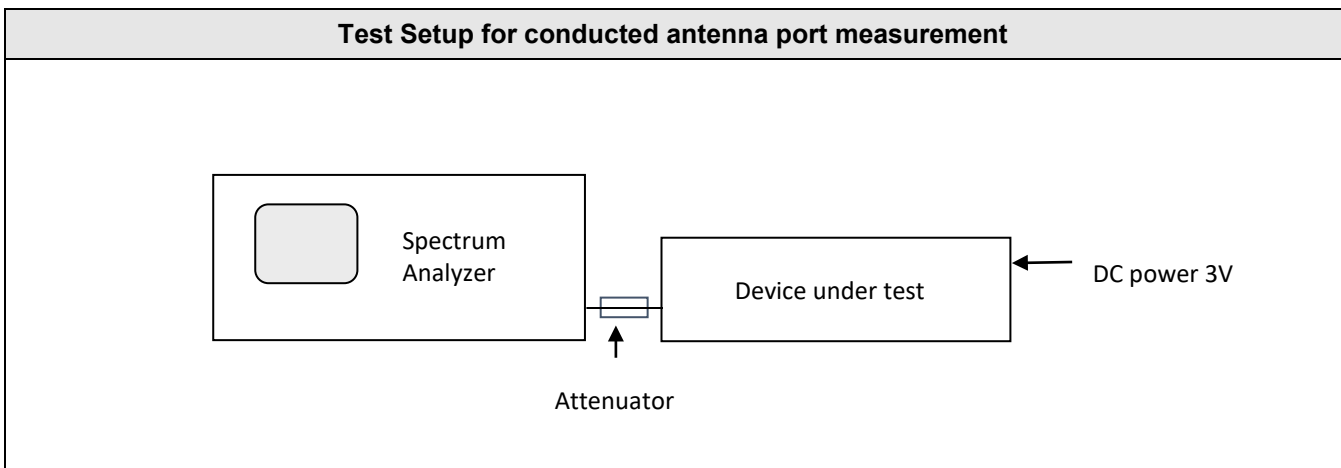

### Tabulated Results for Maximum (Average) output power (Conducted)

FREQ (MHz)	Measured conducted power (dBm)	Duty cycle factor (dB)	Maximum output power (dBm)	Limit (dBm)	Result
903.9 / LORA-B1	13.1	NA	13.1	30.0	Pass
905.3 / LORA-B1	13.1	NA	13.1	30.0	Pass
906.9 / LORA-B2	13.1	NA	13.1	30.0	Pass
908.3 / LORA-B2	13.1	NA	13.1	30.0	Pass
903.9 / FSK-B1	13.0	NA	13.0	30.0	Pass
905.3 / FSK-B1	13.2	NA	13.2	30.0	Pass
906.9 / FSK-B2	13.1	NA	13.1	30.0	Pass
908.3 / FSK-B2	13.2	NA	13.2	30.0	Pass
<b>RESULT:</b>	PASS				
<b>Note:</b>	- Method used is AVGSA-1 - Duty cycle factor is $10 \cdot \log(1/x)$ where x is the duty cycle				

### Tabulated Results for Maximum (Average) output power (Radiated)

FREQ (MHz)	Maximum output power Conducted (dBm)	Max Antenna Gain (dBi)	Maximum output power Radiated (dBm)	Limit (dBm)	Result
903.9 / LORA-B1	13.1	2.2	15.3	36.0	Pass
905.3 / LORA-B1	13.1	2.2	15.3	36.0	Pass
906.9 / LORA-B2	13.1	2.2	15.3	36.0	Pass
908.3 / LORA-B2	13.1	2.2	15.3	36.0	Pass
903.9 / FSK-B1	13.0	2.2	15.2	36.0	Pass
905.3 / FSK-B1	13.2	2.2	15.4	36.0	Pass
906.9 / FSK-B2	13.1	2.2	15.3	36.0	Pass
908.3 / FSK-B2	13.2	2.2	15.4	36.0	Pass
<b>RESULT:</b>	PASS				

## Graphical representation of Conducted output power

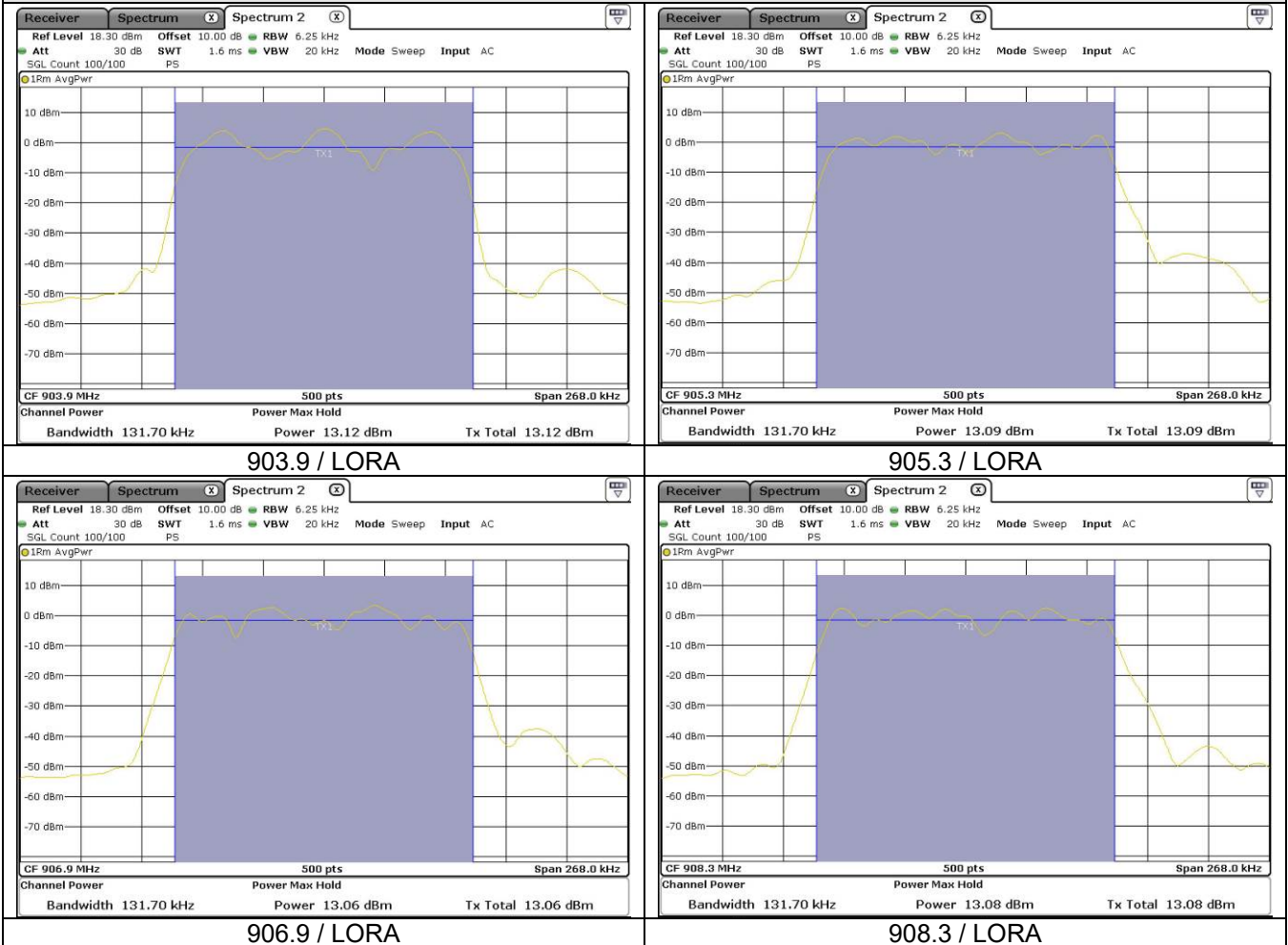



## Graphical representation of Conducted output power

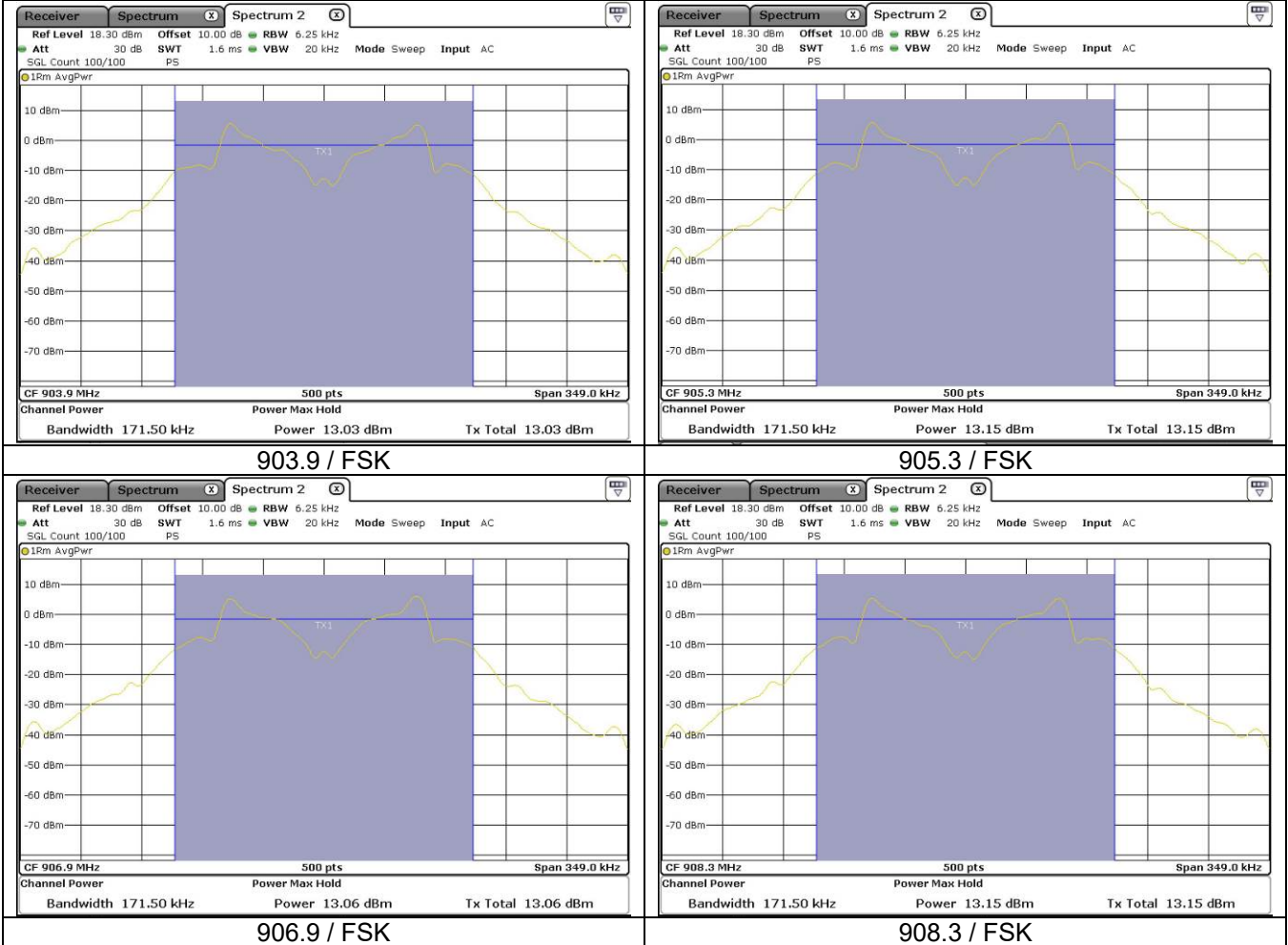



**14. Maximum Power Spectral Density Level in the fundamental emission**

<b>TEST: Maximum Peak Power Spectral Density</b>		<b>Verdict</b>
<p><b>Method:</b> A radiated measurement is performed.            The SPAN is wide enough to capture all products of the modulation process.            Radiated field strength of RF Output Power is measured at 3m in a Full Anechoic Chamber (FAC) that complies with ANSI C63.10.            Maximum field strength is performed by rotating the EUT 360°. All frequencies were investigated in both horizontal and vertical antenna polarity.            Three orthogonal axis measurements on EUT are performed to obtain the maximum peak field strength, with a 60° rotation on each axis. (Clause 6.6.5 of ANSI C63.10).            The tested equipment is set to transmit operation with modulation on low, mid and high channels.</p>		<b>Pass</b>
Laboratory Parameters:	Required prior to the test	During the test
Ambient Temperature	20 to 30 °C	22°C ± 2
Relative Humidity	25 to 70 %	35% ± 5
<b>Limits – FCC Part 15.247 (e) / RSS-247 §5.2 (b)</b>		
<b>Frequency (MHz)</b>	<b>Level (Detector)</b>	<b>Limit</b>
2441.75	8 dBm/3kHz (Pk)	<b>Pass</b>
<p>Supplementary information:            Test location: SMEE.            Test date: December 13<sup>th</sup>, 2018. Tested by L. CHAPUS</p>		

<b>Test Equipment Used</b>					
Description	Manufacturer	Model	Identifier	Cal. Date	Cal. Due
Attenuator	Mini-Circuit	BW-N10W5+	ATT-171-008	2018/4	2019/4
Measuring receiver	Rohde&Schwarz	ESRP	REC-151-003	2017/5	2019/5

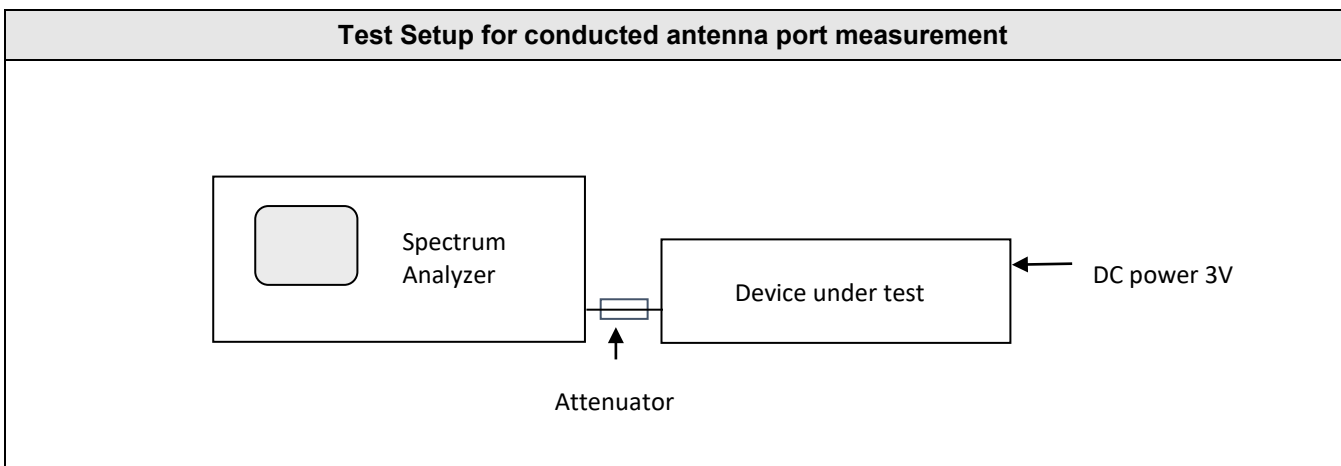

## Tabulated Results for Maximum Conducted Power Spectral Density

Frequency (MHz)	PSD (dBm/3kHz)	Limit	Result
903.9 / LORA-B1	-0.3	8dBm/3kHz	Pass
905.3 / LORA-B1	-0.2	8dBm/3kHz	Pass
906.9 / LORA-B2	-0.3	8dBm/3kHz	Pass
908.3 / LORA-B2	-0.6	8dBm/3kHz	Pass
903.9 / FSK-B1	3.6	8dBm/3kHz	Pass
905.3 / FSK-B1	4.0	8dBm/3kHz	Pass
906.9 / FSK-B2	3.6	8dBm/3kHz	Pass
908.3 / FSK-B2	3.9	8dBm/3kHz	Pass
<b>RBW:</b>	3kHz		
<b>Limit:</b>	FCC Part 15.247 / RSS-247		
<b>RESULT:</b>	PASS		
<b>Note:</b>	Method used is AVGPS-1		

## Graphical representation for Maximum Power Spectral Density

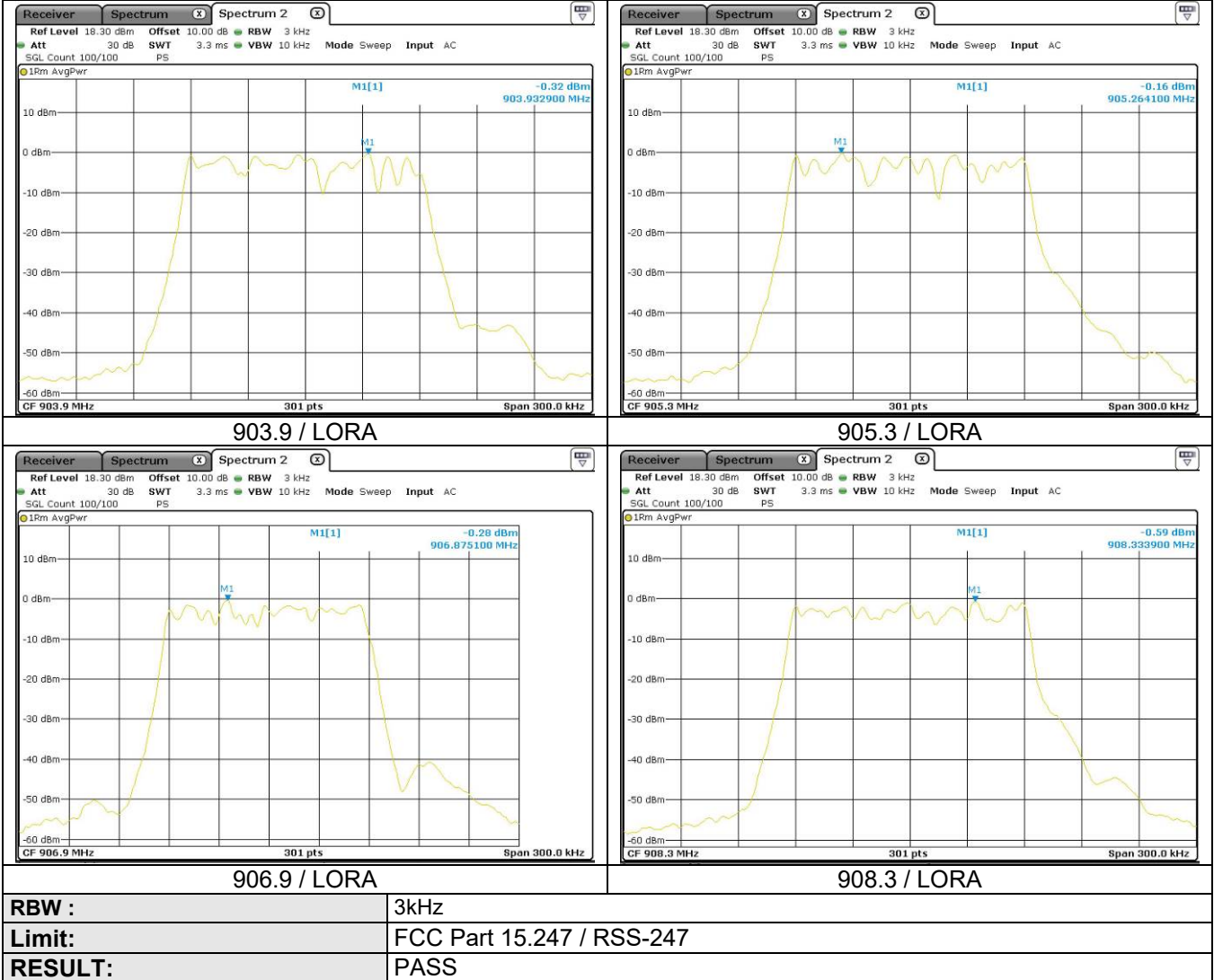

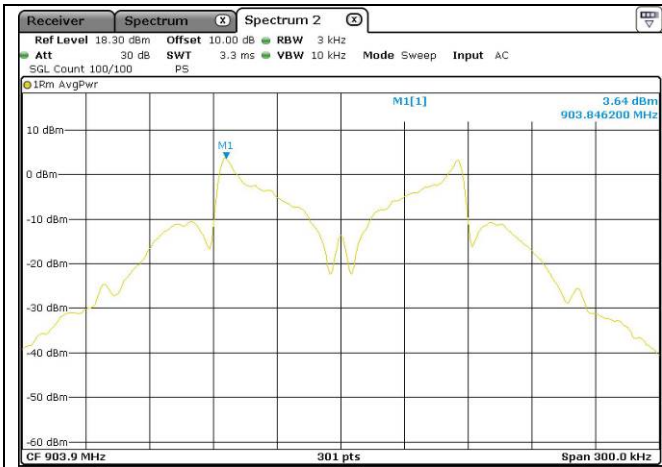

903.9 / FSK

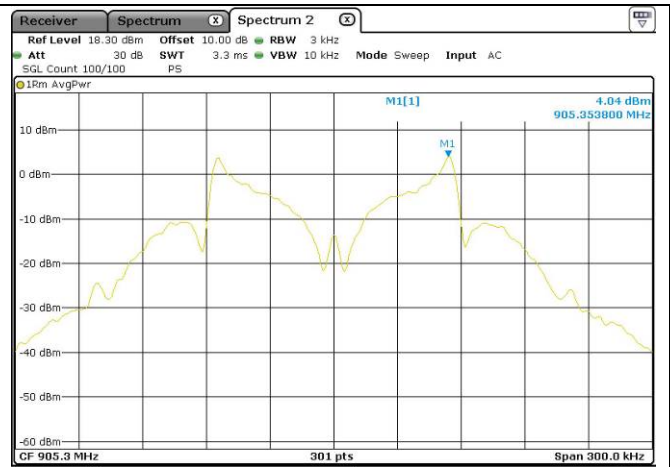

905.3 / FSK

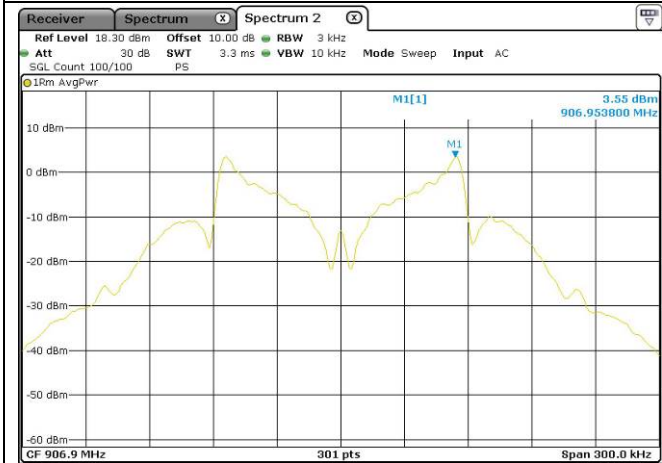

906.9 / FSK

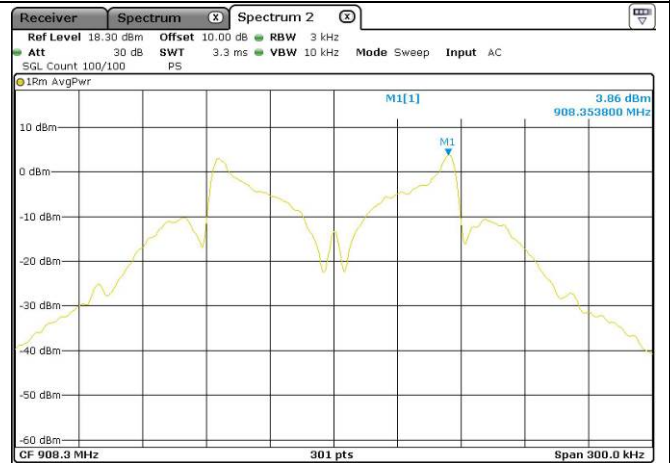

908.3 / FSK

<b>RBW :</b>	3kHz
<b>Limit:</b>	FCC Part 15.247 / RSS-247
<b>RESULT:</b>	PASS

## 15. Unwanted Spurious Emissions (Conducted emissions)

TEST: Conducted Spurious emissions			Verdict
<p><b>Method:</b> The setup is in an anechoic chamber. The spectrum analyzer is connected to the antenna port of the device under test. A conducted measurement is performed.</p> <p>The tested equipment is set to transmit operation with modulation on low, mid and high channels.</p>			<b>Pass</b>
Laboratory Parameters:	Required prior to the test	During the test	
Ambient Temperature	20 to 30 °C	22°C ± 2	
Relative Humidity	25 to 70 %	35% ± 5	
Fully configured sample scanned over the following frequency range	Frequency range on each side of line	Measurement Point	
	30MHz – 10GHz	Antenna port	
Limits – FCC Part 15.247 (d) / RSS-247 § 5.5			
Frequency (MHz)	Limits (dBµV/m)		
	Detector / Analyser RBW	Limit	Results
30 to 10000	Pk / 100kHz	30dB below the maximum Peak level	<b>Pass</b>
<p>Supplementary information:            Test location: SMEE.            Test date: December 14<sup>th</sup>, 2018. Tested by L. CHAPUS</p>			

Test Equipment Used					
Description	Manufacturer	Model	Identifier	Cal. Date	Cal. Due
Attenuator	Mini-Circuit	BW-N10W5+	ATT-171-008	2018/4	2019/4
Spectrum analyzer	Rohde&Schwarz	FSV40	ASP-171-004	2017/5	2019/5

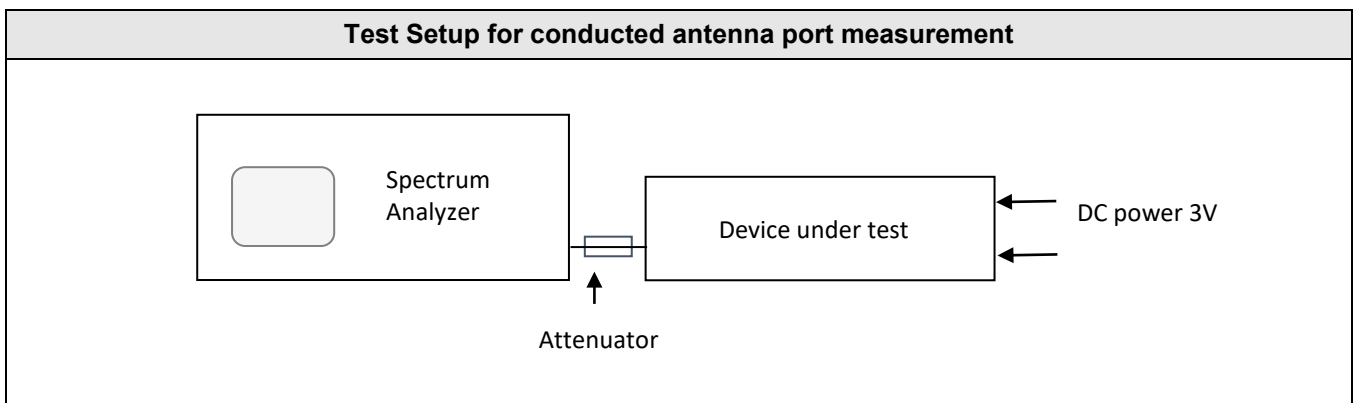

## Graphical representation of Conducted Spurious emissions (LORA mode / Low and High channels,B1)

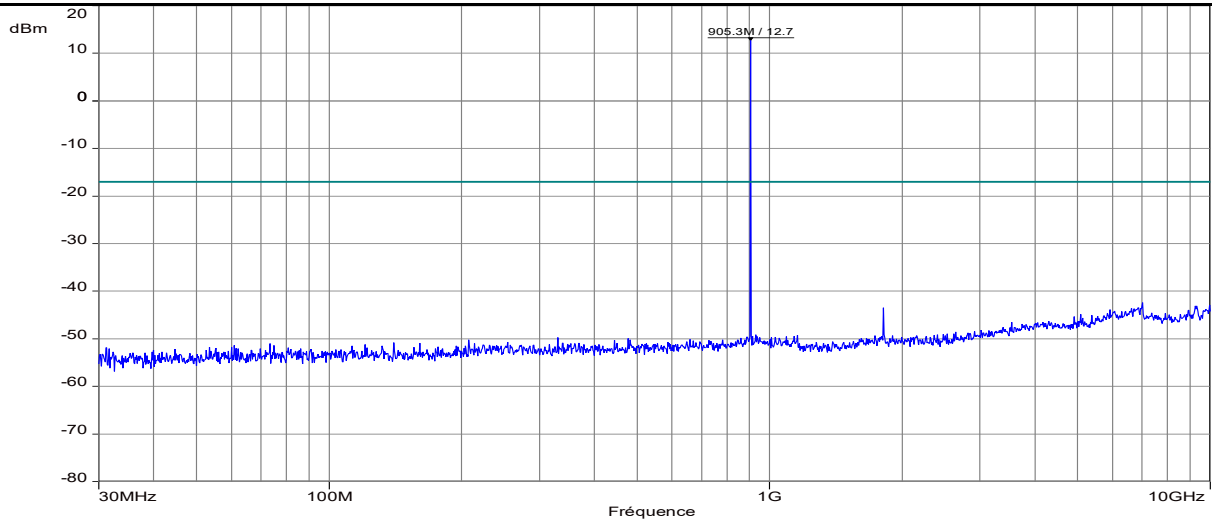
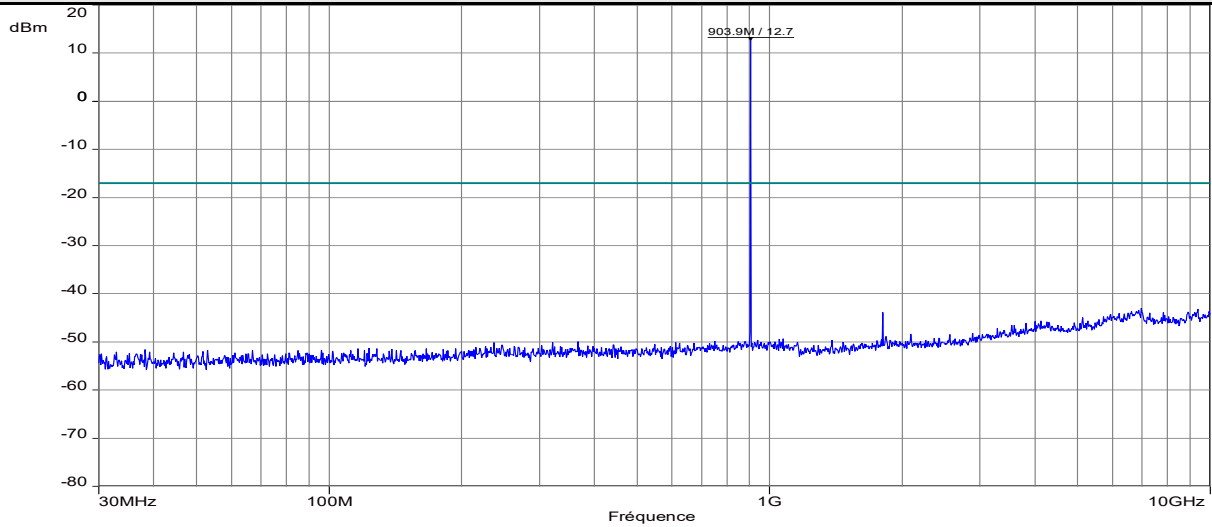

<b>Frequency band investigated:</b>	30MHz-10GHz
<b>Unit :</b>	dBm
<b>RBW :</b>	100kHz (Frequency step 50kHz)
<b>Measurement detector:</b>	Peak
<b>Limit:</b>	-17.3dBm

## Graphical representation of Conducted Spurious emissions (LORA mode / Low and High channels,B2)

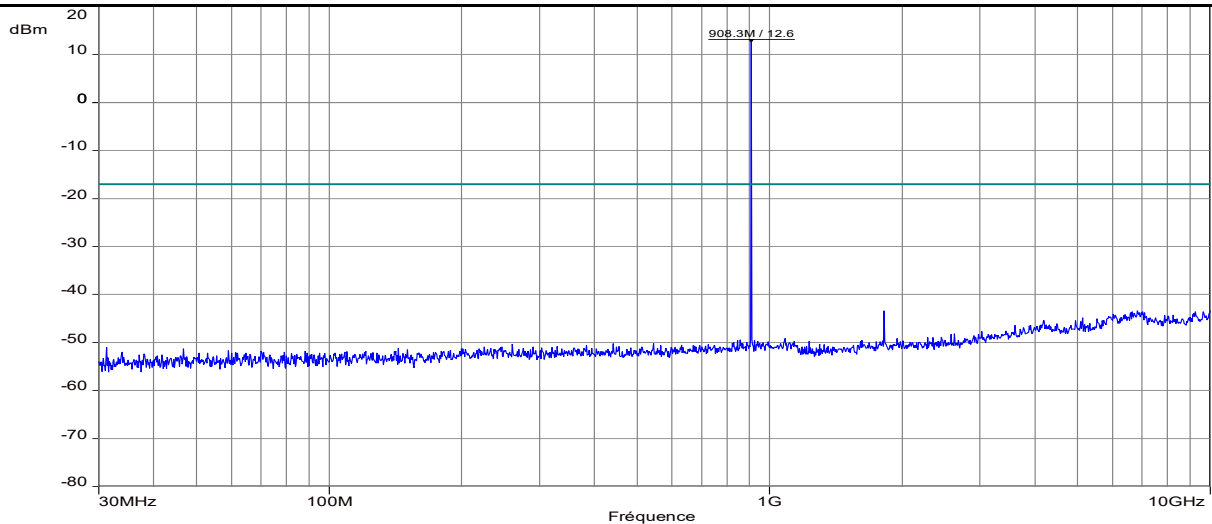
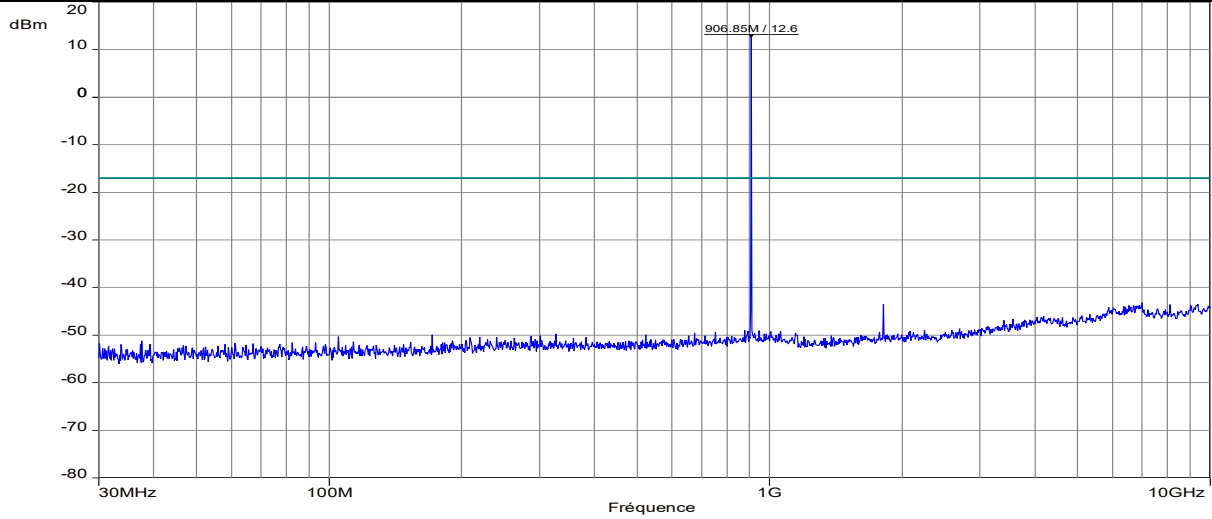

<b>Frequency band investigated:</b>	30MHz-10GHz
<b>Unit :</b>	dBm
<b>RBW :</b>	100kHz (Frequency step 50kHz)
<b>Measurement detector:</b>	Peak
<b>Limit:</b>	-17.4dBm

## Graphical representation of Conducted Spurious emissions (FSK mode / Low and High channels,B1)

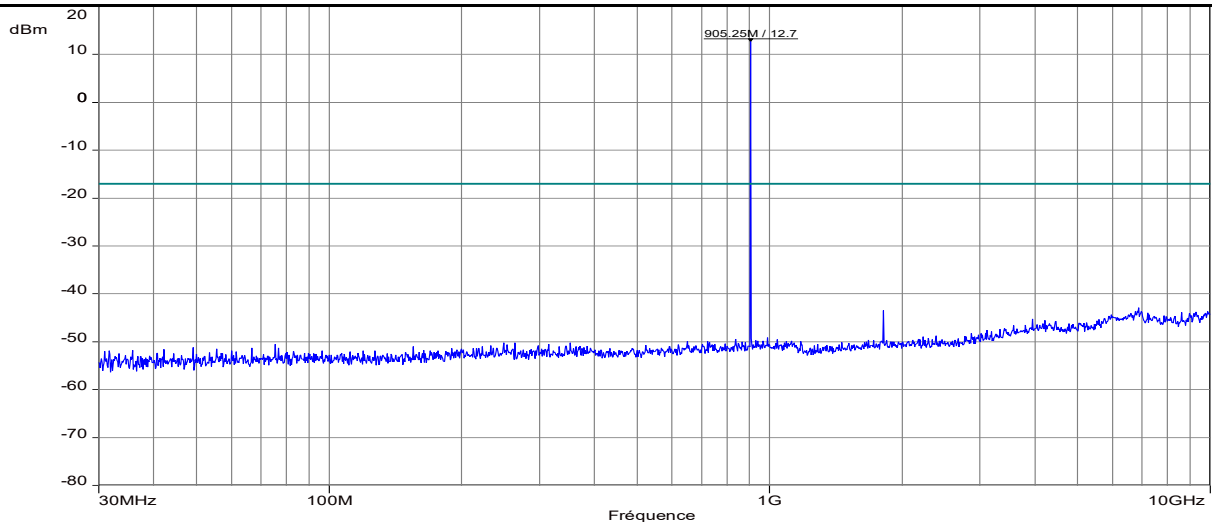
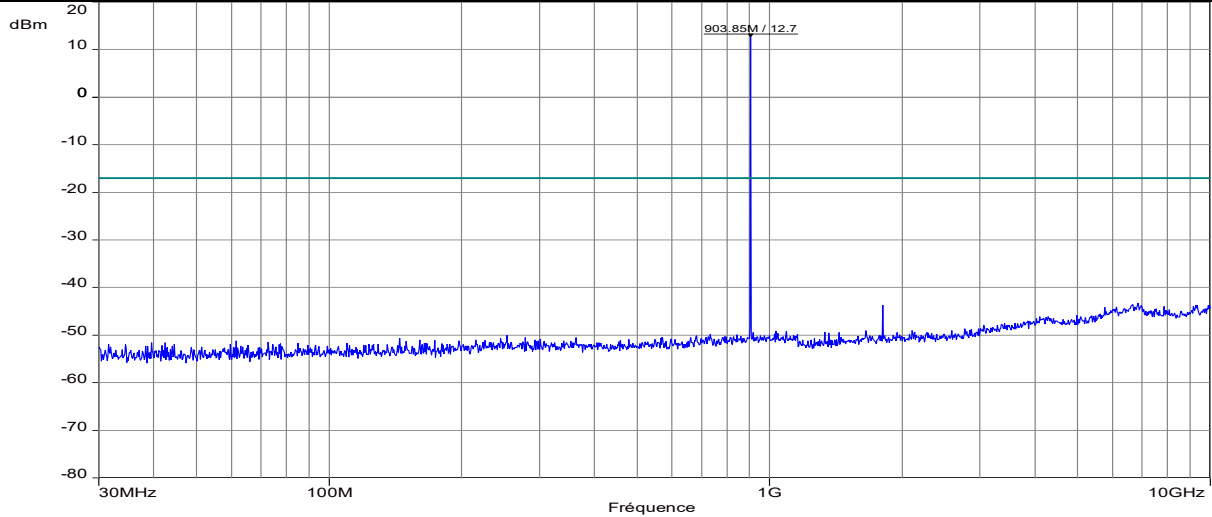

<b>Frequency band investigated:</b>	30MHz-10GHz
<b>Unit :</b>	dBm
<b>RBW :</b>	100kHz (Frequency step 50kHz)
<b>Measurement detector:</b>	Peak
<b>Limit:</b>	-17.3dBm



## Graphical representation of Conducted Spurious emissions (FSK mode / Low and High channels,B2)

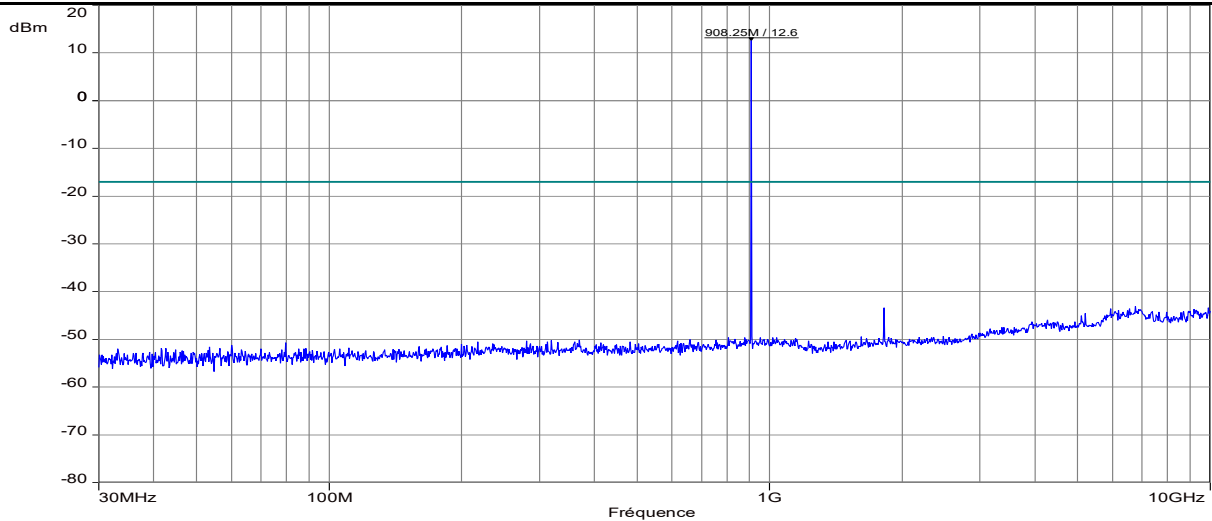
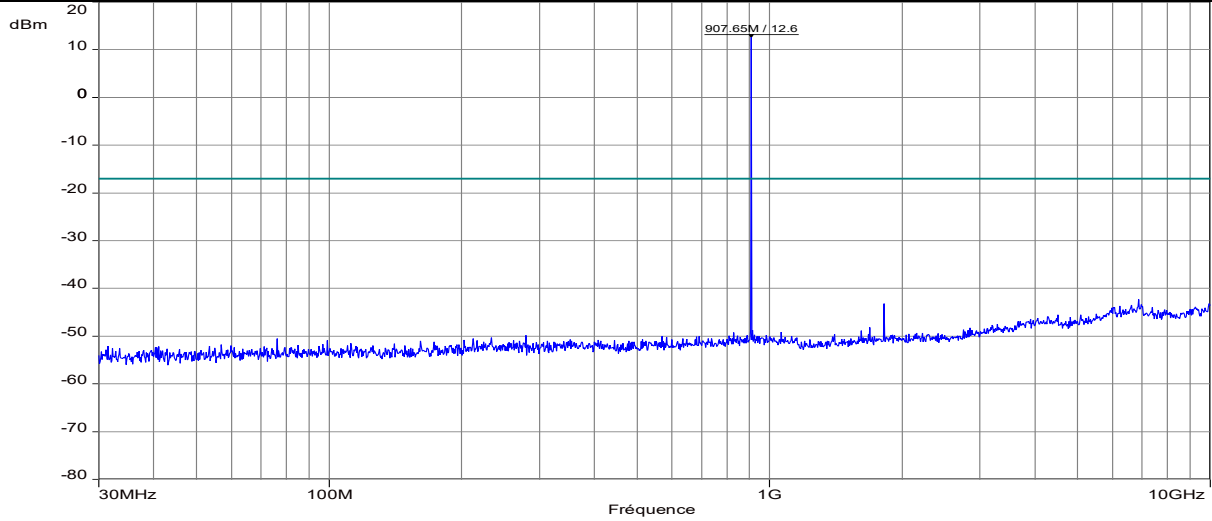

<b>Frequency band investigated:</b>	30MHz-10GHz
<b>Unit :</b>	dBm
<b>RBW :</b>	100kHz (Frequency step 50kHz)
<b>Measurement detector:</b>	Peak
<b>Limit:</b>	-17.4dBm

## Graphical representation of Band-edge compliance (LOW)

### LORA / Hopping Disable

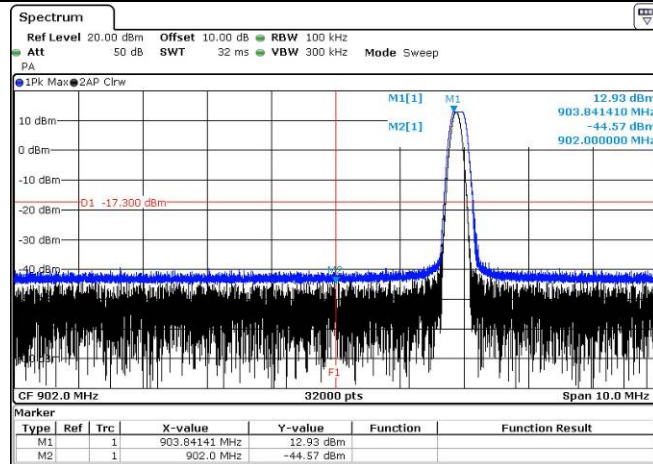

### LORA / Hopping Enabled

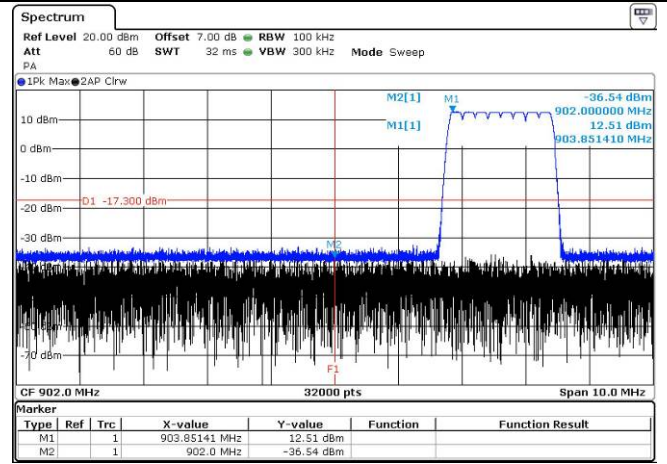

### FSK / Hopping Disable

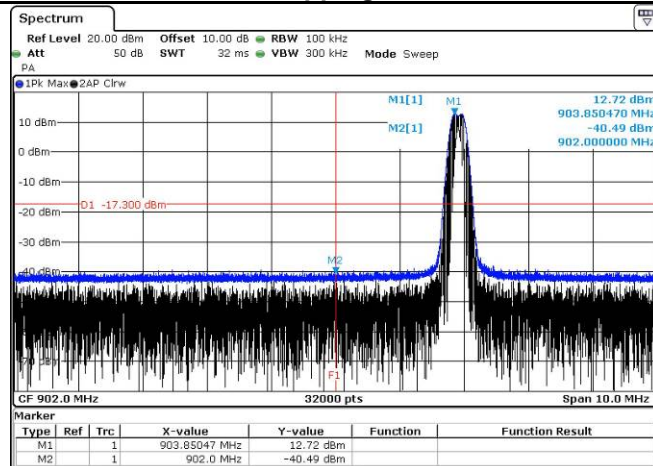

### FSK / Hopping Enabled

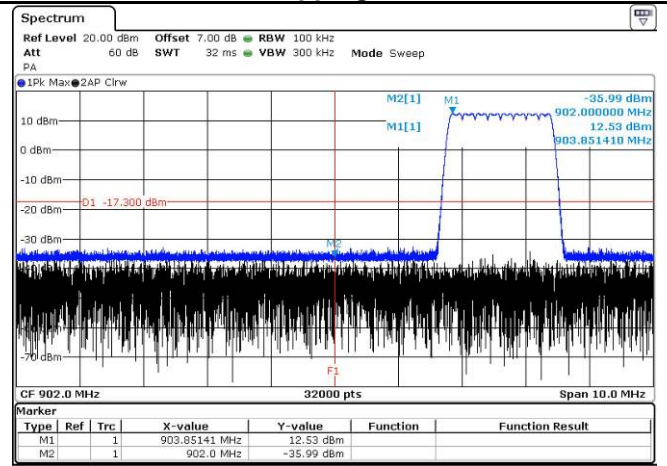

Unit :	dBm
RBW :	100kHz
Measurement detector:	Peak
Limit:	-17.4dBm
Note:	F1 is 902MHz

## Graphical representation of Band-edge compliance (High)

### LORA / Hopping Disable

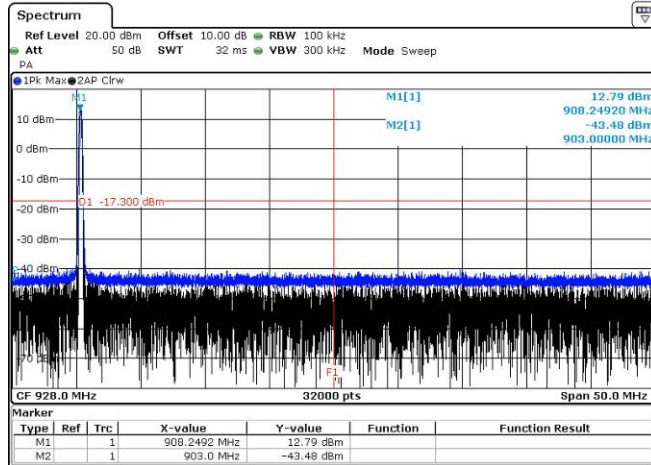

### LORA / Hopping Enabled

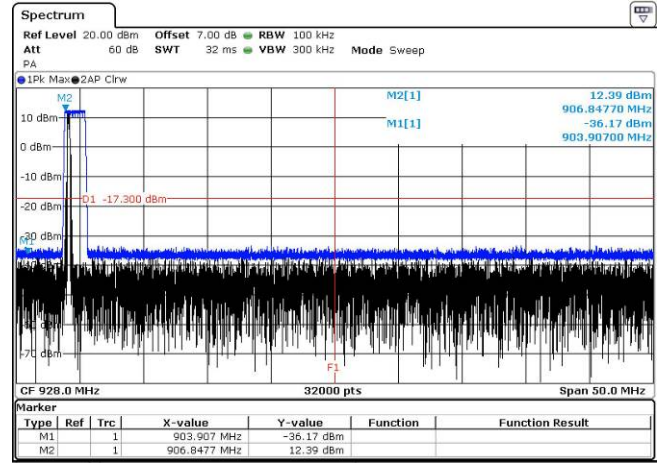

### FSK / Hopping Disable

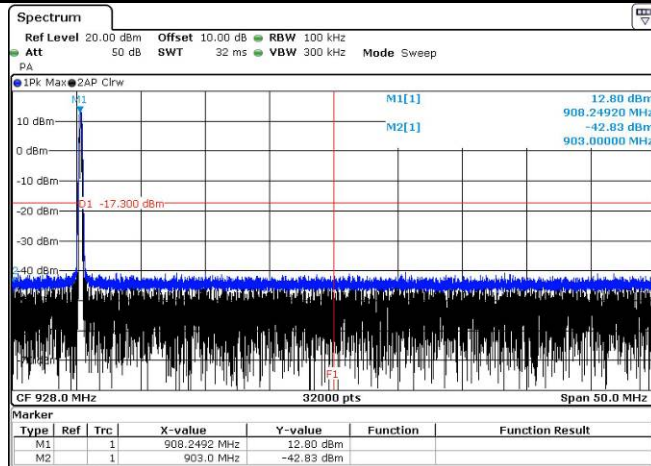

### FSK / Hopping Enabled

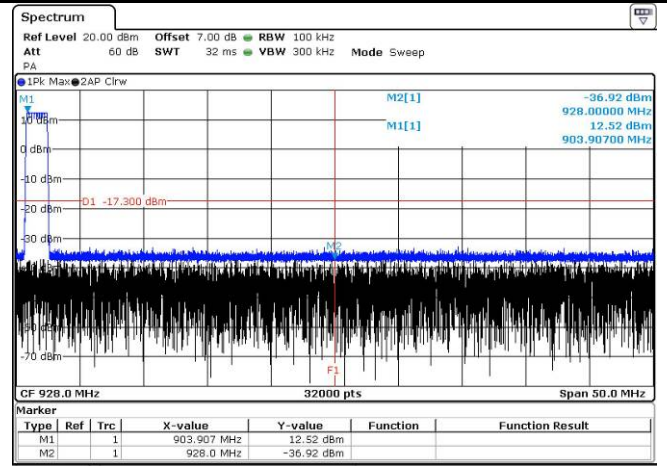

<b>Unit :</b>	dBm
<b>RBW :</b>	100kHz
<b>Measurement detector:</b>	Peak
<b>Limit:</b>	-17.4dBm
<b>Note:</b>	F1 is 902MHz

## 16. Unwanted emissions in Non-Restricted Frequency bands (Radiated emissions)

TEST: Unwanted emissions in Non-Restricted Frequency Bands			Verdict
<p><b>Method:</b> Measurements were performed on a 3-meter Open Area Test Site (OATS) for frequency below 1GHz. The EUT was rotated 360° about its azimuth with the receive antenna located at various heights in horizontal and vertical polarities. Final measurements (Peak) were then performed by rotating the EUT on 360° and adjusting the receive antenna height from 1 to 4 m</p> <p>For frequency above 1GHz, final measurements were made at 3m in a Full Anechoic Chamber (FAC) that complies with ANSI C63.10. Measurements were performed at an antenna to EUT separation distance of 3 meter. The EUT was rotated 360° about its azimuth with the receive antenna in horizontal and vertical polarities.</p> <p>Three orthogonal axis measurements on EUT are performed to obtain the maximum peak field strength, with 60° rotation on each axis. (Clause 6.6.5 of ANSI C63.10).</p> <p>A pre-scan frequency identification of the EUT has been performed in full anechoic chamber. The measured radiated field of the EUT is performed (or corrected) at 3-meters of distance. Antenna is 1.25-meters high. The pre-characterization graphs are obtained in PEAK detection with 360° continuous rotation of the device under test.</p>			<b>Pass</b>
Laboratory Parameters:	Required prior to the test	During the test	
Ambient Temperature	20 to 30 °C	22°C ± 2	
Relative Humidity	25 to 70 %	35% ± 5	
Fully configured sample scanned over the following frequency range	Frequency range on each side of line	Measurement Point	
	30MHz – 10GHz	3 m measurement distance	
<b>Limits – FCC Part 15.247 (d) / RSS-247 § 5.5</b>			
Frequency (MHz)	Limits (dBµV/m)		
	Detector / Analyser RBW	Limit	Results
30 to 10000	Pk / 100kHz	30dB below the maximum Peak level	<b>Pass</b>
Supplementary information: Test location: SMEE. Test date: December 14 <sup>th</sup> , 2018. Tested by L. CHAPUS			

Test Equipment Used					
Description	Manufacturer	Model	Identifier	Cal. Date	Cal. Due
Log-periodic antenna	TDK	PLP3003	ANT-101-001	2017/5	2019/5
Biconnic antenna	COM-POWER	AB- 900	ANT-101-003	2017/5	2019/5
BiConiLog antenna	EMCO	3142B	ANT-101-010	2017/7	2019/7
Horn antenna	ETS-LINDGREN	3115	ANT-141-013	2018/10	2021/10
Spectrum analyzer	Rohde&Schwarz	FSV40	ASP-171-004	2017/5	2019/5
RF cable	Div	OATS/25m	CAB-101-017	2018/4	2019/4
RF cable	Pasternack RF	PE302-120	CAB-131-024	2018/4	2019/4
RF cable	HUBER+SUHNER	RG214U	CAB-141-026	2018/4	2019/4
RF cable	HUBER+SUHNER	RG214U	CAB-141-029	2018/4	2019/4
RF cable	HUBER+SUHNER	SF104	CAB-141-030	2018/4	2019/4

Test Equipment Used					
Description	Manufacturer	Model	Identifier	Cal. Date	Cal. Due
Anechoic chamber	COMTEST	214263	CAG-141-001	2017/6	2020/6
Antenna mast	Innco- Systems	MA4000EP	MAT-101-001	-	-
Turntable	Innco- Systems	DS1200S	PLA-101-001	-	-
Turntable	Innco- Systems	CT0800	PLA-141-001		
Pre-amplifier	Pasternack RF	1524	PRE-101-002	2018/4	2019/4
Measuring receiver	Rohde&Schwarz	ESRP	REC-151-003	2017/5	2019/5
OATS	Div	10m	SIT-101-001	2017/7	2020/7
EMC Software	NEXIO	BAT EMC V3.8	SOF-101-001	-	-

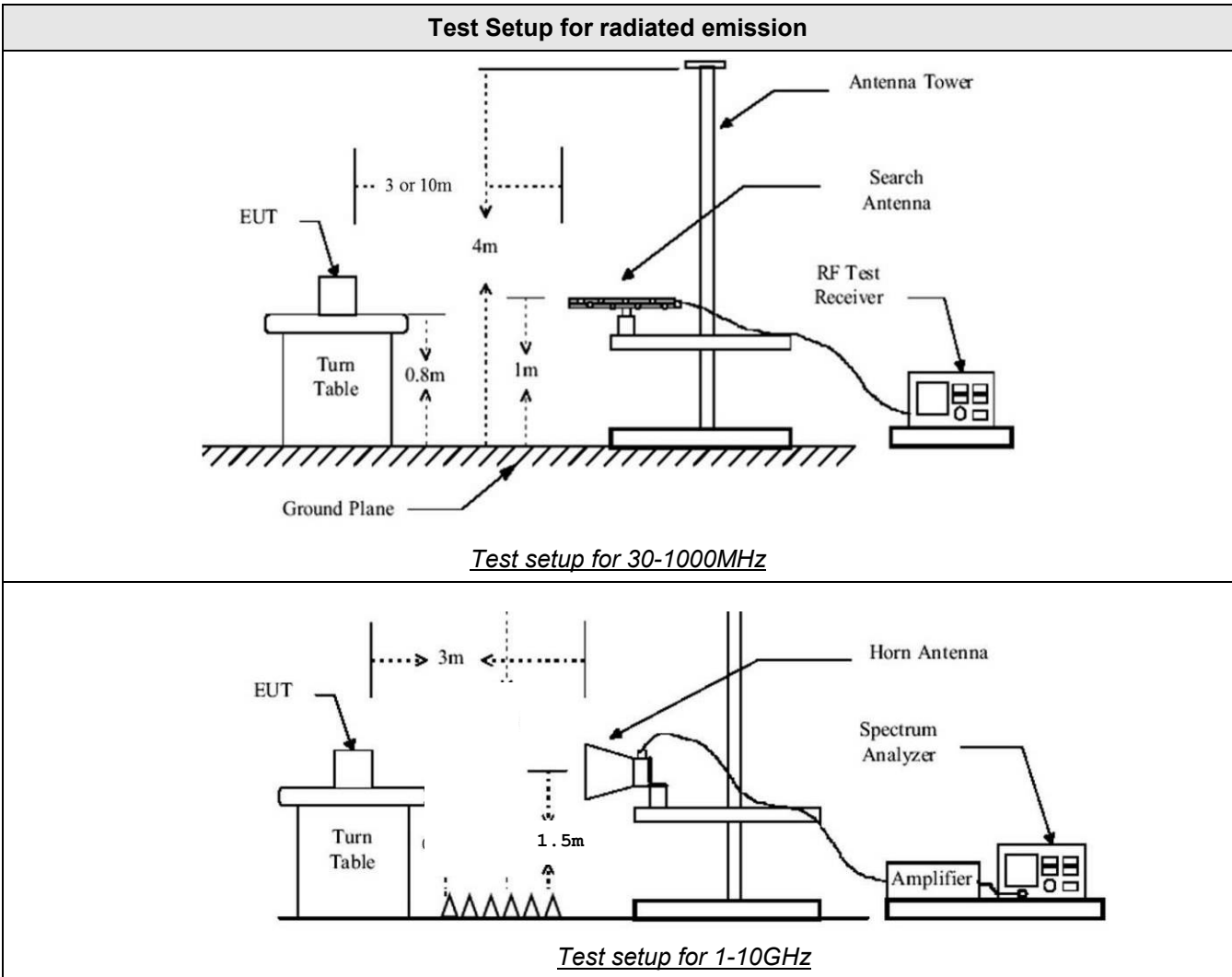

Tabulated Results for Peak Output Radiated level (Antenna #1)	
FREQ (MHz)	Field Strength 3m (dB $\mu$ V/m)
903.9 / LORA-B1	111.0
905.3 / LORA-B1	111.0
906.9 / LORA-B2	111.4
908.3 / LORA-B2	111.4
903.9 / FSK-B1	111.0
905.3 / FSK-B1	111.0
906.9 / FSK-B2	111.4
908.3 / FSK-B2	111.4
<b>RBW:</b>	100kHz
<b>Measurement distance:</b>	3m
<b>Limit:</b>	Ref. level only – For 15.247 (d) / RSS-247 § 5.5
<b>Final measurement detector:</b>	Peak
<b>Note:</b>	(1): Only for identification of limit in non-restricted band Limit is <b>81.0 dB<math>\mu</math>V/m</b> Peak for out-of-band frequencies in Non-Restricted bands (with a 100kHz RBW on the spectrum analyser)

Tabulated Results for Peak Output Radiated level (Antenna #2)	
FREQ (MHz)	Field Strength 3m (dB $\mu$ V/m)
903.9 / LORA-B1	113.0
905.3 / LORA-B1	113.0
906.9 / LORA-B2	113.4
908.3 / LORA-B2	113.4
903.9 / FSK-B1	113.0
905.3 / FSK-B1	113.0
906.9 / FSK-B2	113.4
908.3 / FSK-B2	113.4
<b>RBW:</b>	100kHz
<b>Measurement distance:</b>	3m
<b>Limit:</b>	Ref. level only – For 15.247 (d) / RSS-247 § 5.5
<b>Final measurement detector:</b>	Peak
<b>Note:</b>	(1): Only for identification of limit in non-restricted band Limit is <b>83.0 dB<math>\mu</math>V/m</b> Peak for out-of-band frequencies in Non-Restricted bands (with a 100kHz RBW on the spectrum analyser)

Tabulated Results for Unwanted emissions in Non-Restricted bands				
FREQ (MHz)	Field Strength 3m (dBµV/m)	Limit (dBµV/m)	Margin (dBµV/m)	Result (dBµV/m)
Levels are at least 10 dB below the -30dBc limit				
<b>RBW:</b>	100kHz			
<b>Measurement distance:</b>	3m			
<b>Limit:</b>	15.247 / RSS-247			
<b>Final measurement detector:</b>	Peak			
<b>RESULT:</b>	PASS			
<b>Note:</b>	<p>(1): The field strength (level) is calculated by adding the Antenna Factor and Cable Factor, and subtracting the Amplifier Gain (if any) from the measured reading. The basic equation is as follow:  <math>FS = RA + AF + CF - AG</math>            Where FS = Field Strength            RA = Receiver Amplitude            AF = Antenna Factor            CF = Cable Factor            AG = Amplifier Gain            Total factor (dB) is <math>AF + CF - AG</math>            Margin value = Emission level – Limit value</p> <p>(2): Peak pre-scans not performed at 3-meters distance are corrected as follow:  <math>M@3m = M@D_m + 20 \times \log(D_m / 3m)</math>            Where D is the measurement distance in meter</p> <p>(3): All frequencies not specified have margin &lt; -10dB</p> <p>(4): 3-axis measurement performed for device under test.</p>			



## Graphical representation of Band-edge compliance (LOW) / Antenna #1

### LORA / Hopping Disable

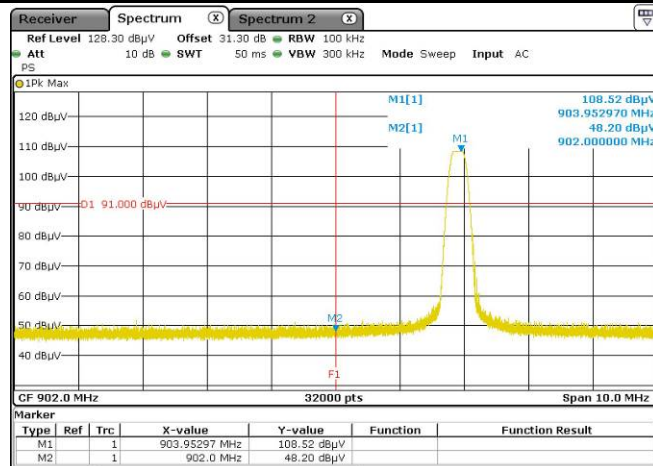

### LORA / Hopping Enabled

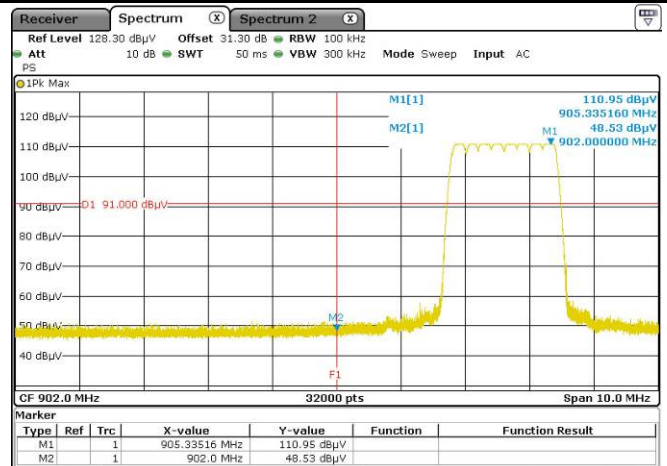

### FSK / Hopping Disable

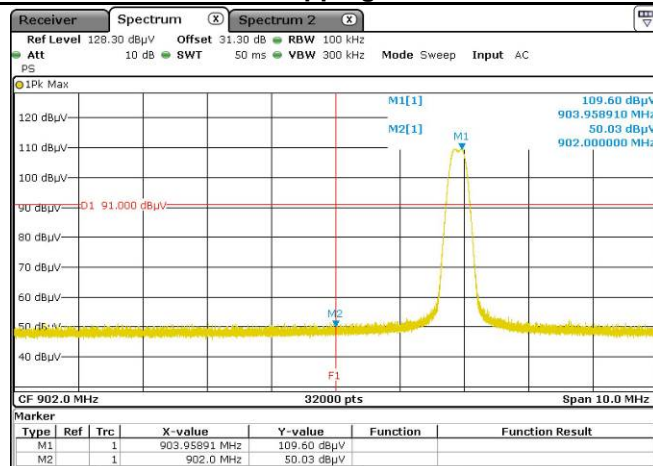

### FSK / Hopping Enabled

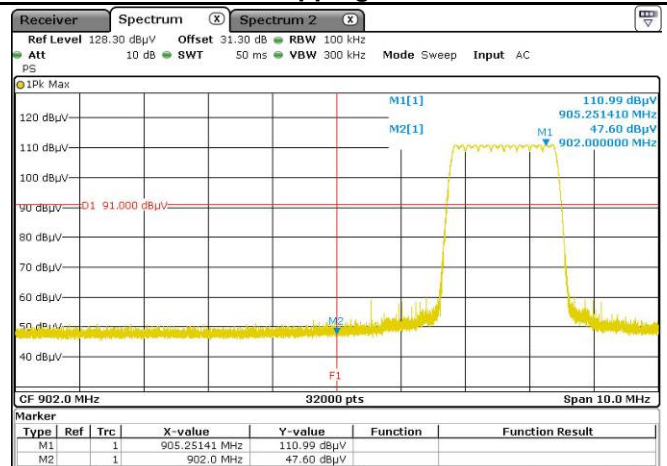

<b>Unit :</b>	dBm
<b>RBW :</b>	100kHz
<b>Measurement detector:</b>	Peak
<b>Note:</b>	F1 is 902MHz



## Graphical representation of Band-edge compliance (High) / Antenna #1

### LORA / Hopping Disable

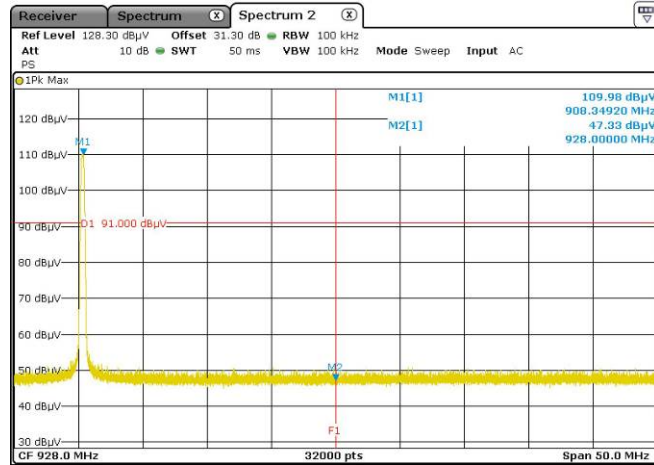

### LORA / Hopping Enabled

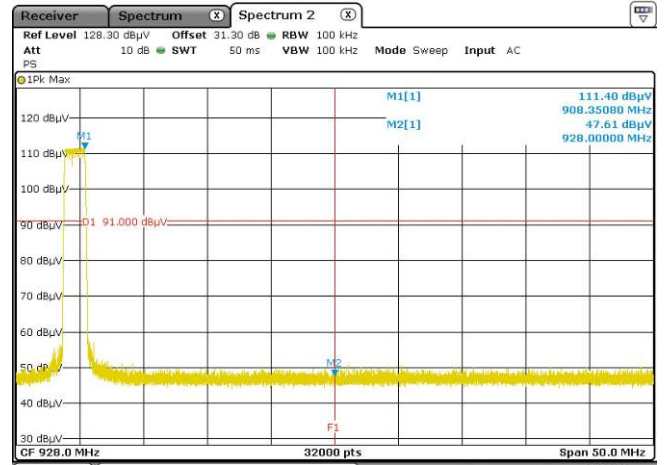

### FSK / Hopping Disable

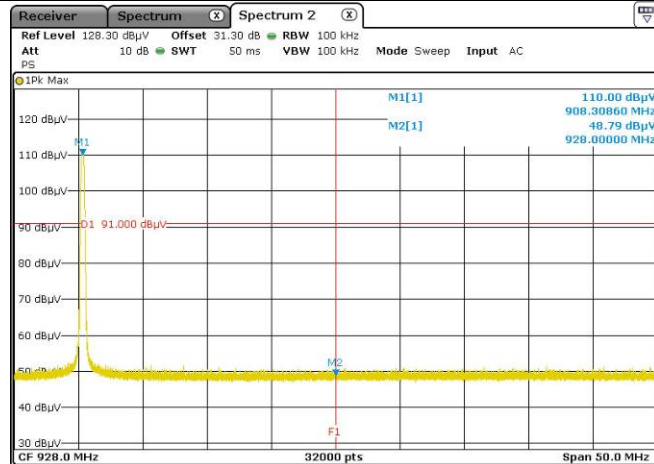

### FSK / Hopping Enabled

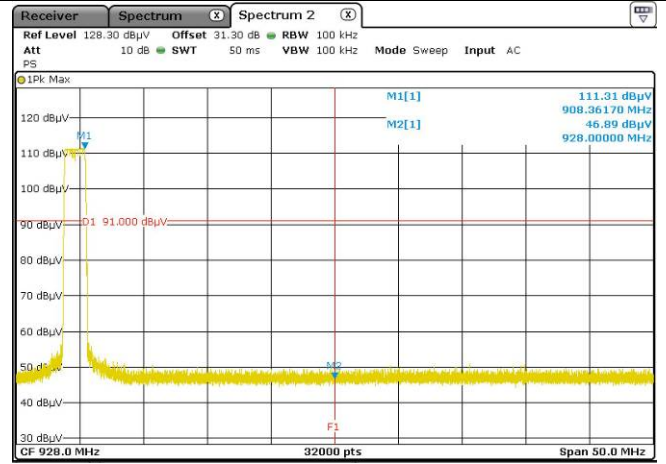

Unit :	dBm
RBW :	100kHz
Measurement detector:	Peak
Note:	F1 is 928MHz

## Graphical representation of Band-edge compliance (LOW) / Antenna #2

### LORA / Hopping Disable

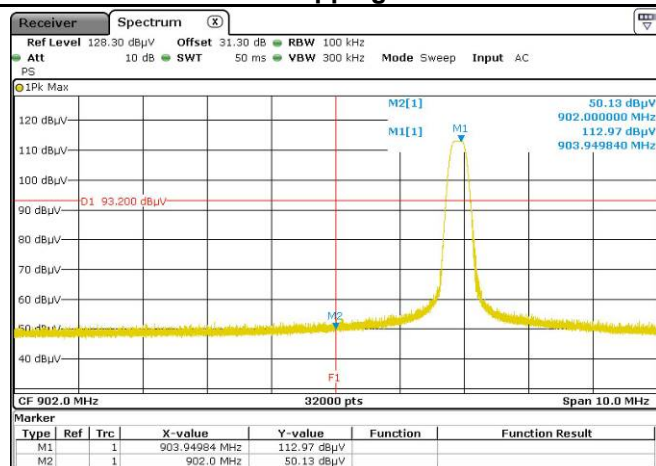

### LORA / Hopping Enabled

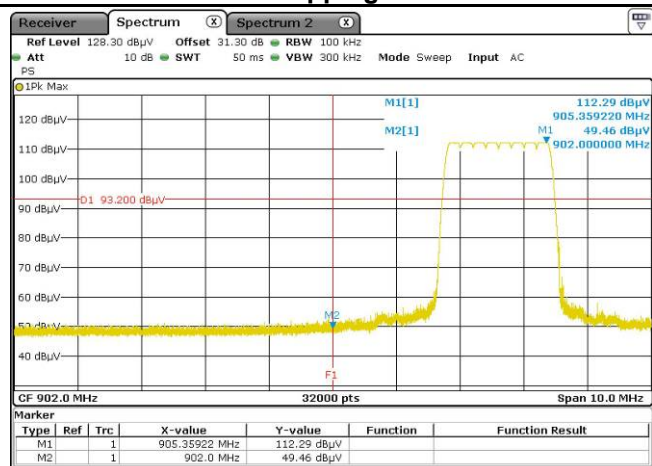

### FSK / Hopping Disable

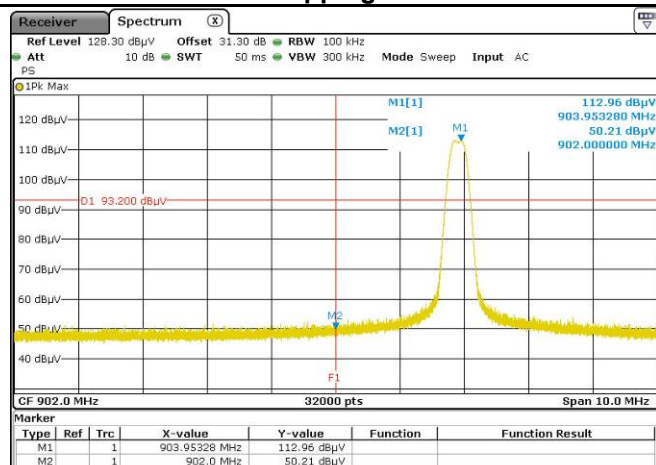

### FSK / Hopping Enabled

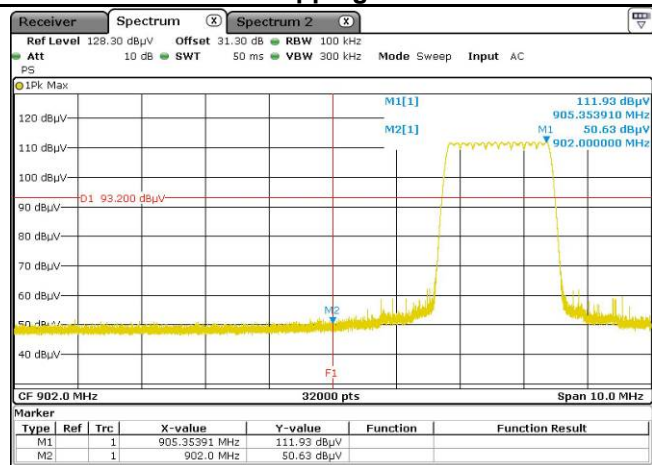

<b>Unit :</b>	dBm
<b>RBW :</b>	100kHz
<b>Measurement detector:</b>	Peak
<b>Note:</b>	F1 is 902MHz

## Graphical representation of Band-edge compliance (High) / Antenna #2

### LORA / Hopping Disable

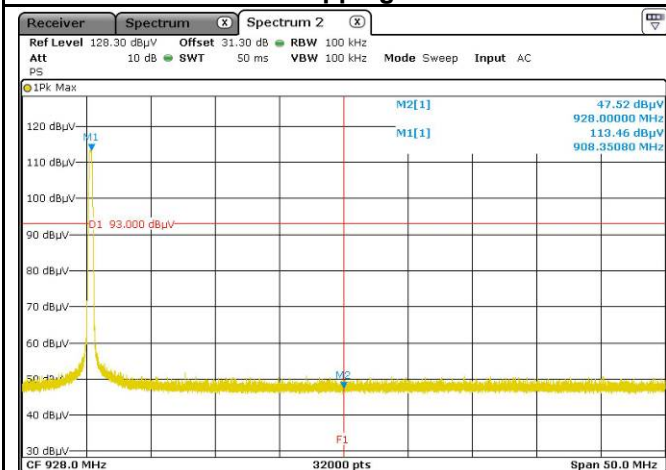

### LORA / Hopping Enabled

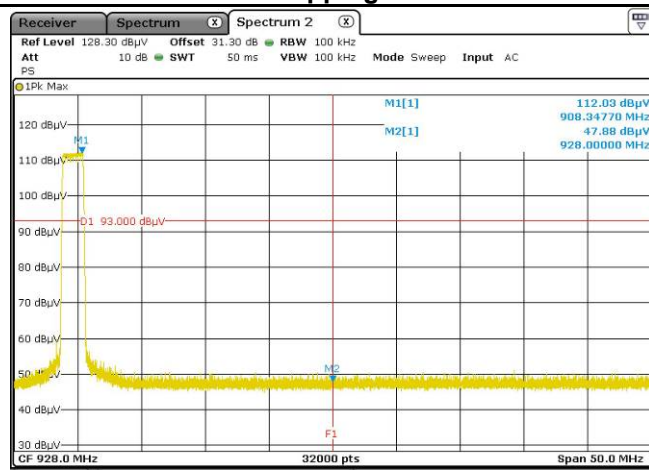

### FSK / Hopping Disable

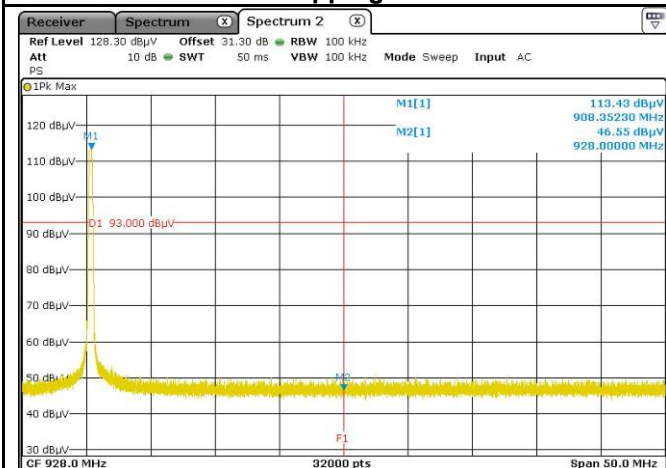

### FSK / Hopping Enabled

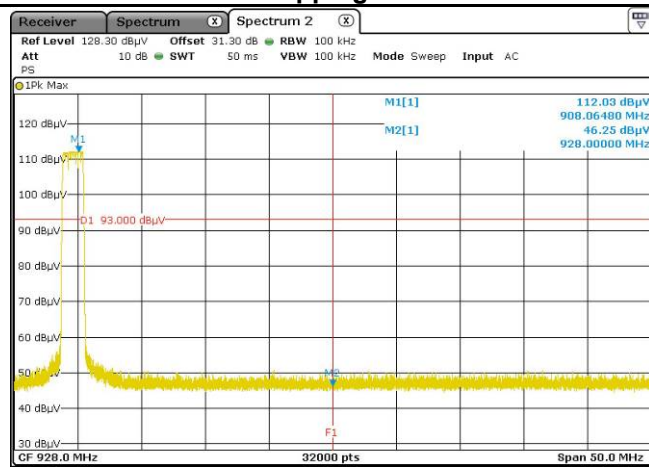

Unit :	dBm
RBW :	100kHz
Measurement detector:	Peak
Note:	F1 is 928MHz

## 17. Unwanted emissions in Restricted Frequency bands

TEST: Unwanted emissions into Restricted Frequency Bands		Verdict
<p><b>Method:</b> Measurements were performed on a 10 or 3-meter Open Area Test Site (OATS) for frequency below 1GHz. The EUT was rotated 360° about its azimuth with the receive antenna located at various heights in horizontal and vertical polarities. Final measurements (Peak) were then performed by rotating the EUT on 360° and adjusting the receive antenna height from 1 to 4 m for frequency between 30MHz to 1GHz. For frequency above 1GHz, final measurements were made at 3m in a Full Anechoic Chamber (FAC) that complies with ANSI C63.10. Measurements were performed at an antenna to EUT separation distance of 3 meter. The EUT was rotated 360° about its azimuth with the receive antenna in horizontal and vertical polarities.</p> <p>Three orthogonal axis measurements on EUT are performed to obtain the maximum peak field strength, with 60° rotation on each axis.(Clause 6.6.5 of ANSI C63.10).</p> <p>A pre-scan frequency identification of the EUT has been performed in full anechoic chamber. The measured radiated field of the EUT is performed (or corrected) at 3-meters of distance. Antenna is 1.25-meters high. The pre-characterization graphs are obtained in PEAK detection with 360° continuous rotation of the device under test.</p>		<b>Pass</b>
Laboratory Parameters:	Required prior to the test	During the test
Ambient Temperature	20 to 30 °C	22°C ± 2
Relative Humidity	25 to 70 %	35% ± 5
Fully configured sample scanned over the following frequency range	Frequency range on each side of line	Measurement Point
	9kHz – 30MHz	10 m measurement distance
	30MHz – 10GHz	3 m measurement distance
<b>Limits – FCC Part 15.205, 15.209 (a), 15.247 (d) / RSS-GEN §8.9, §8.10, RSS-247 §5.5</b>		
Frequency (MHz)	Limits (dBµV/m)	
	Level / Detector / Distance	Results
0.009 to 0.090	107.6 – 87.6 / AV / 10m 127.6 – 107.6 / PK / 10m	<b>Pass</b>
0.090 to 0.110	87.6 – 85.9 / QP / 10m	<b>Pass</b>
0.110 to 0.490	85.7 – 72.9 / AV / 10m 105.7 – 92.9 / PK / 10m	<b>Pass</b>
0.490 to 1.705	52.9 – 42.1 / QP / 10m	<b>Pass</b>
1.705 to 30	48.6 / QP / 10m	<b>Pass</b>
30 to 88	40.0 / QP / 3m	<b>Pass</b>
88 to 216	43.5 / QP / 3m	<b>Pass</b>
216 to 960	46.0 / QP / 3m	<b>Pass</b>
960-1000	54.0 / QP / 3m	<b>Pass</b>
Above 1GHz	54.0 / AV / 3m 74.0 / PK / 3m	<b>Pass</b>
Supplementary information: Test location: SMEE. Test date: December 14 <sup>th</sup> , 2018. Tested by L. CHAPUS		

Test Equipment Used					
Description	Manufacturer	Model	Identifier	Cal. Date	Cal. Due
Log-periodic antenna	TDK	PLP3003	ANT-101-001	2017/5	2019/5
Biconnic antenna	COM-POWER	AB- 900	ANT-101-003	2017/5	2019/5
Loop antenna	EMCO	6502	ANT-101-009	2017/8	2019/8
BiConiLog antenna	EMCO	3142B	ANT-101-010	2017/7	2019/7
Horn antenna	ETS-LINDGREN	3115	ANT-141-013	2018/10	2021/10
Horn antenna	ETS-LINDGREN	3116	ANT-161-014	2017/12	2022/12
Spectrum analyzer	Rohde&Schwarz	FSV40	ASP-171-004	2017/5	2019/5
RF cable	Div	OATS/25m	CAB-101-017	2018/4	2019/4
RF cable	Pasternack RF	PE302-120	CAB-131-024	2018/4	2019/4
RF cable	HUBER+SUHNER	RG214U	CAB-141-026	2018/4	2019/4
RF cable	HUBER+SUHNER	RG214U	CAB-141-029	2018/4	2019/4
RF cable	HUBER+SUHNER	SF104	CAB-141-030	2018/4	2019/4
RF cable	HUBER+SUHNER	SF102 (K/2m)	CAB-171-034	2017/5	2019/5
RF cable	HUBER+SUHNER	SF102 (K/3m)	CAB-171-034	2017/5	2019/5
Anechoic chamber	COMTEST	214263	CAG-141-001	2017/6	2020/6
Antenna mast	Innco- Systems	MA4000EP	MAT-101-001	-	-
Turntable	Innco- Systems	DS1200S	PLA-101-001	-	-
Turntable	Innco- Systems	CT0800	PLA-141-001		
Pre-amplifier	Pasternack RF	1524	PRE-101-002	2018/4	2019/4
Pre-amplifier	SMEE	18-40GHz	PRE-171-004	2017/12	2018/12
Measuring receiver	Rohde&Schwarz	ESRP	REC-151-003	2017/5	2019/5
OATS	Div	10m	SIT-101-001	2017/7	2020/7
EMC Software	NEXIO	BAT EMC V3.8	SOF-101-001	-	-

**Test Setup for radiated emission**

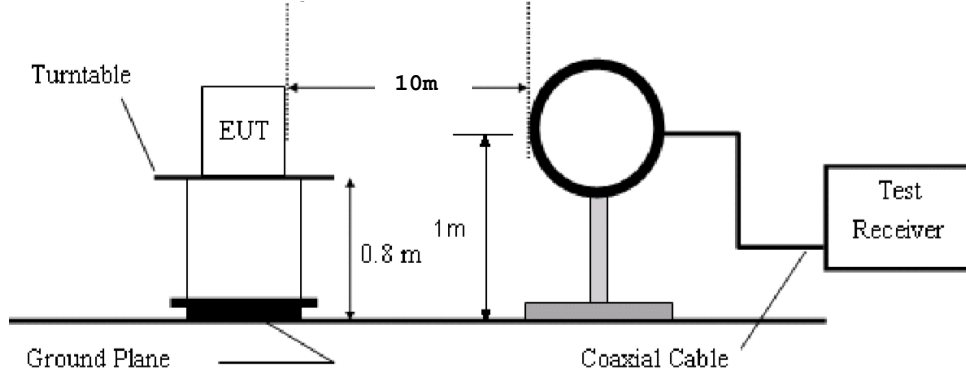

*Test setup for 9k-30MHz*

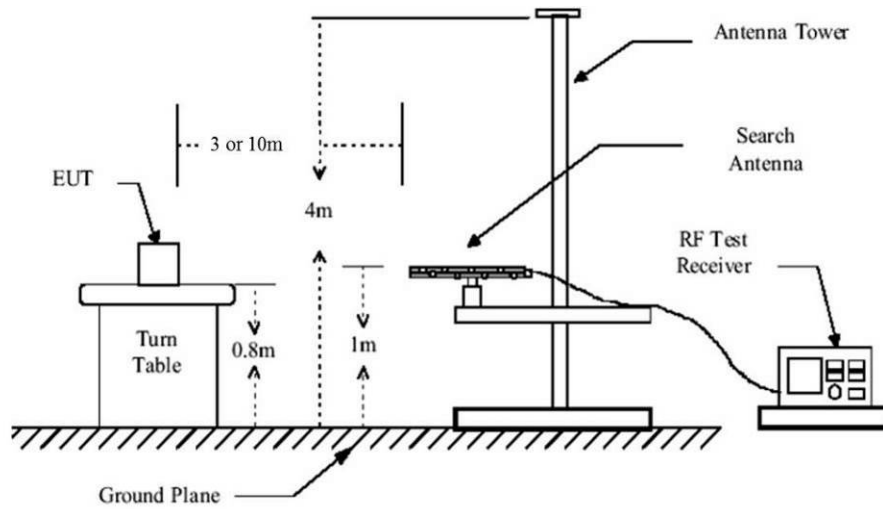

*Test setup for 30-1000MHz*

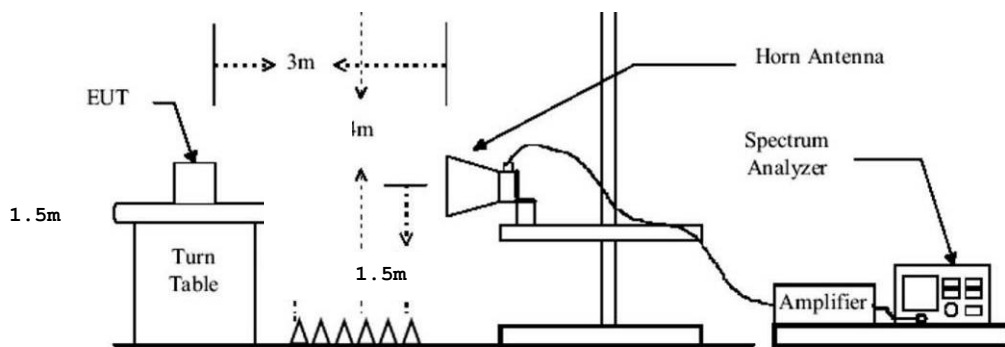

*Test setup for 1-10GHz*

Tabulated Results for Unwanted emissions (9kHz-30MHz)						
FREQ	RF field @ 30m	Limit @ 30m	Margin	Antenna angle	Table angle	Correc. Fact. (CF)
MHz	(QP) dBµV/m	(QP) dBµV/m	dB	Degree	Degree	dB
Margin < -10dB						
Supplementary information: Frequency list measured on the Open Area Test Site has been created with pre-scan results.						
<b>Frequency band investigated:</b>		9kHz-30MHz				
<b>RBW:</b>		200Hz (9kHz-150kHz) 9kHz (150kHz-30MHz)				
<b>Measurement distance:</b>		10m				
<b>Limit:</b>		FCC Part 15.205 - 15.209 / RSS-GEN				
<b>Final measurement detector:</b>		Peak / Quasi-Peak / Average				
<b>Note:</b>		CF: Correction factor = Antenna factor + Cable loss *1: Measure have been done at 10m distance and corrected according to requirements of 15.209.e) (M@30m = M@10m-19.1dB)				

Tabulated Results for Unwanted emissions (30MHz-1GHz)										
FREQ	Meter reading	Meter reading	Total factor	Field level	Field level	Pol	Antenna height	Table angle	Limit	Margin
MHz	(QP) dBµV	(Pk) dBµV	dB	(QP) dBµV/m	(Pk) dBµV/m		cm	Degré	(QP) dBµV/m	dB
Margin < -10dB										
Supplementary information: Frequency list measured on the Open Area Test Site has been created with pre-scan results.										
<b>Frequency band investigated:</b>		30MHz-1GHz								
<b>RBW:</b>		120kHz								
<b>Measurement distance:</b>		3m								
<b>Limit:</b>		FCC Part 15.205 - 15.209 / RSS-GEN								
<b>Final measurement detector:</b>		Quasi-Peak								
<b>RESULT:</b>		PASS								
<b>Field Strength Calculation:</b>		<p>The field strength (level) is calculated by adding the Antenna Factor and Cable Factor, and subtracting the Amplifier Gain (if any) from the measured reading. The basic equation is as follow:</p> $FS = RA + AF + CF - AG$ <p>Where FS = Field Strength  RA = Receiver Amplitude  AF = Antenna Factor  CF = Cable Factor  AG = Amplifier Gain</p> <p>Total factor (dB) is AF + CF - AG  Margin value = Emission level - Limit value</p>								



Tabulated Results for Unwanted emissions (1GHz-10GHz)					
FREQ (MHz)	Field Strength 3m (dBµV/m)	Detector	Limit (dBµV/m)	Margin (dBµV/m)	Result
<b>LORA MODE</b>					
7255.2	60.1	Pk	74	-13.9	<b>Pass</b>
7255.2	50.5	Avg	54	-3.5	<b>Pass</b>
7266.4	60.3	Pk	74	-13.7	<b>Pass</b>
7266.4	51.0	Avg	54	-3.0	<b>Pass</b>
<b>FSK MODE</b>					
7255.2	60.1	Pk	74	-13.9	<b>Pass</b>
7255.2	50.5	Avg	54	-3.5	<b>Pass</b>
7266.4	60.3	Pk	74	-13.7	<b>Pass</b>
7266.4	51.0	Avg	54	-3.0	<b>Pass</b>
<b>RBW</b>		1MHz			
<b>Measurement distance:</b>		3m			
<b>Limit:</b>		FCC Part 15.205, 15.209, 15.247 / RSS-Gen, RSS-247			
<b>Final measurement detector:</b>		Peak / CISPR Average			
<b>RESULT:</b>		PASS			
<b>Notes:</b>		<p>(1): The field strength (level) is calculated by adding the Antenna Factor and Cable Factor, and subtracting the Amplifier Gain (if any) from the measured reading. The basic equation is as follow:  <math>FS = RA + AF + CF - AG</math>            Where FS = Field Strength            RA = Receiver Amplitude            AF = Antenna Factor            CF = Cable Factor            AG = Amplifier Gain            Total factor (dB) is <math>AF + CF - AG</math>            Margin value = Emission level – Limit value</p> <p>(2): All frequencies not specified have margin &lt; -10dB (for peak and average detector)</p>			



**Graphical representation of Radiated Disturbance Measurement (Peak detection, Anechoic chamber pre-scan, 9kHz-30MHz / 3m / Parallel & Perpendicular antenna position / Transmit mode)**

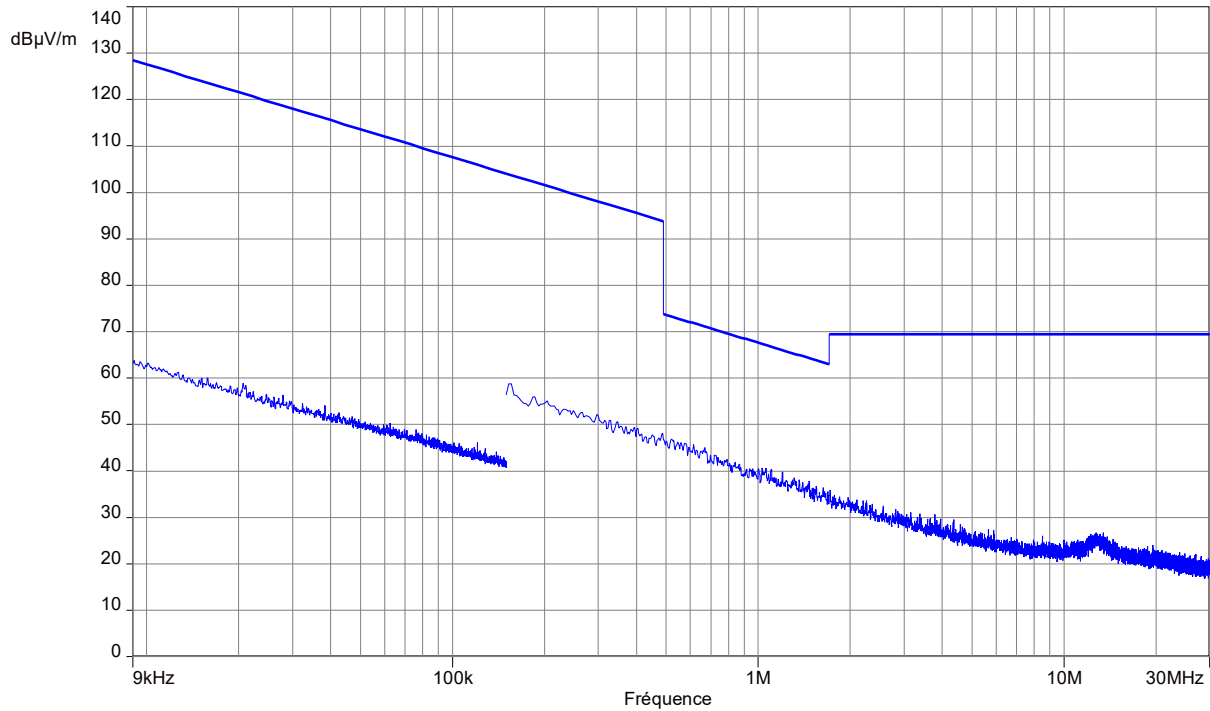

Notes: Pre-scan graph only for identification purpose.  
Same result for all transmit modes on all channels with antenna #1 and #2.

<b>Frequency band investigated:</b>	9kHz-30MHz
<b>Unit :</b>	dBµV/m
<b>RBW :</b>	200Hz (9kHz-150kHz) 9kHz (150kHz-30MHz)
<b>Antenna polarization :</b>	Parallel & Perpendicular to measurement axis
<b>Measurement detector:</b>	Peak

**Graphical representation of Radiated Disturbance Measurement (Peak detection, Anechoic chamber pre-scan, 30MHz-1GHz / 3m / Horizontal & Vertical / Mid channel. Antenna #1.**

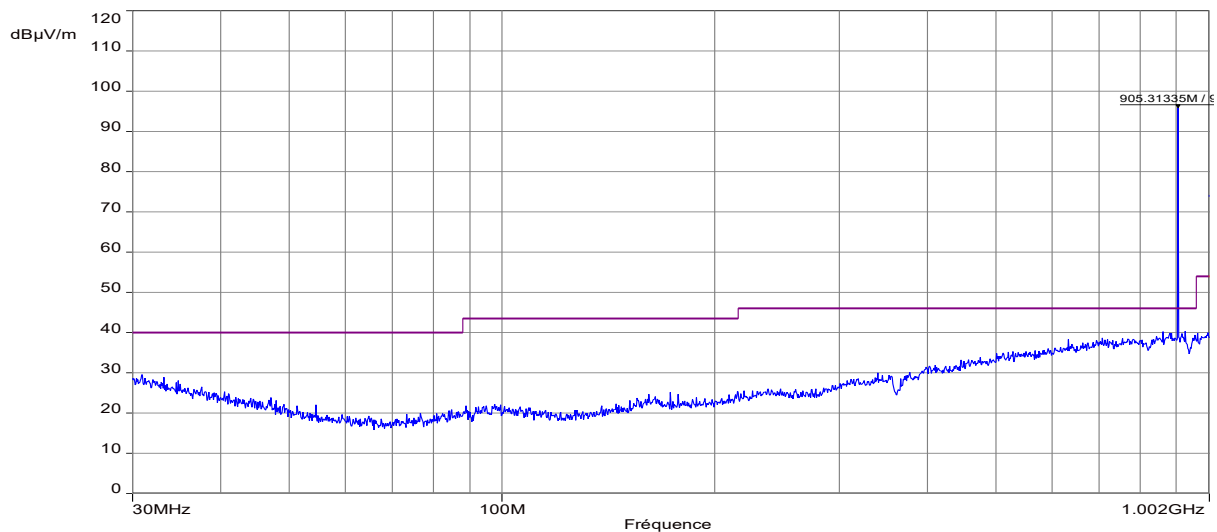
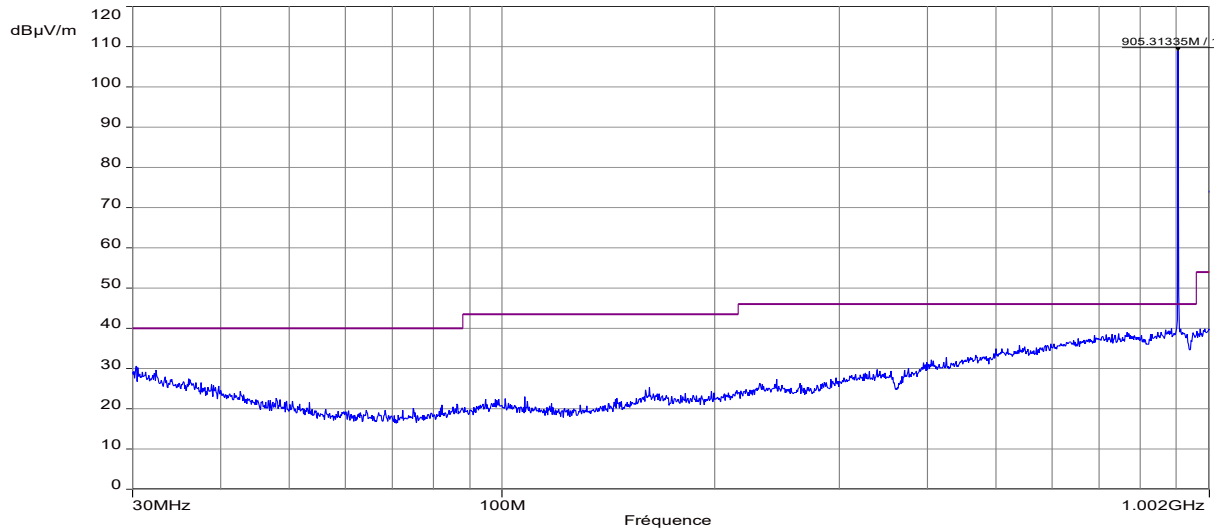

Note: Pre-scan graph only for identification purpose.

Same results for LORA or FSK modes. Pre-scan performed on the mid channel of the whole frequency band.

<b>Frequency band investigated:</b>	30MHz-1GHz				
<b>Unit :</b>	dBµV/m				
<b>RBW :</b>	100kHz				
<b>Antenna polarization :</b>	Horizontal & Vertical				
<b>Limit:</b>	FCC 15.247 / RSS-247				
<b>Measurement detector:</b>	Peak				
PEAK LIST FROM PRE-SCAN					
Frequency (MHz)	Peak Level (dBµV/m)	Angle (°)	Limit (dBµV/m)	Polarization	Comments
None	-	-	-	-	-

**Graphical representation of Radiated Disturbance Measurement (Peak detection, Anechoic chamber pre-scan, 30MHz-1GHz / 3m / Horizontal & Vertical / Mid channel. Antenna #2.**

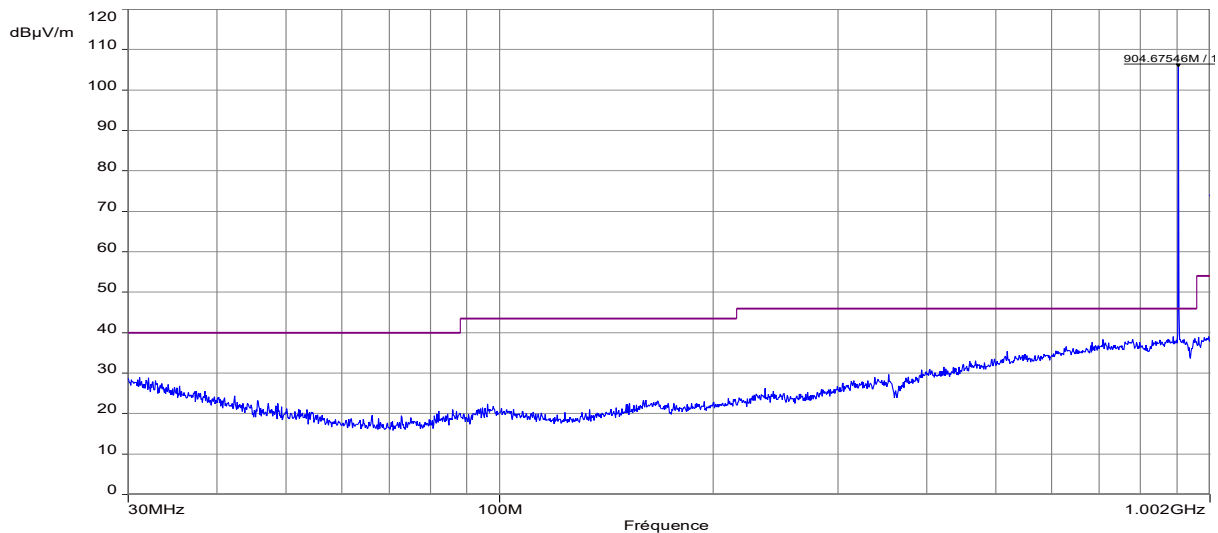
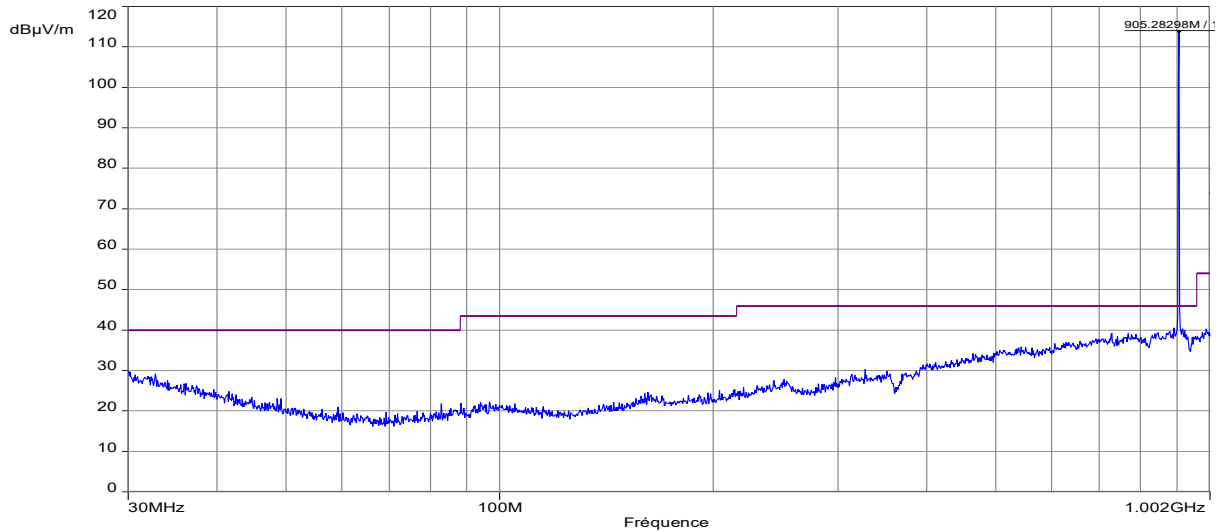

Note: Pre-scan graph only for identification purpose.

Same results for LORA or FSK modes. Pre-scan performed on the mid channel of the whole frequency band.

<b>Frequency band investigated:</b>	30MHz-1GHz				
<b>Unit :</b>	dBµV/m				
<b>RBW :</b>	100kHz				
<b>Antenna polarization :</b>	Horizontal & Vertical				
<b>Limit:</b>	FCC 15.247 / RSS-247				
<b>Measurement detector:</b>	Peak				
PEAK LIST FROM PRE-SCAN					
Frequency (MHz)	Peak Level (dBµV/m)	Angle (°)	Limit (dBµV/m)	Polarization	Comments
None	-	-	-	-	-

## Graphical representation of Radiated Disturbance Measurement (Anechoic chamber pre-scan, 1GHz-10GHz / 3m / Horizontal & Vertical) – Low channel / Lora mode / Antenna #1

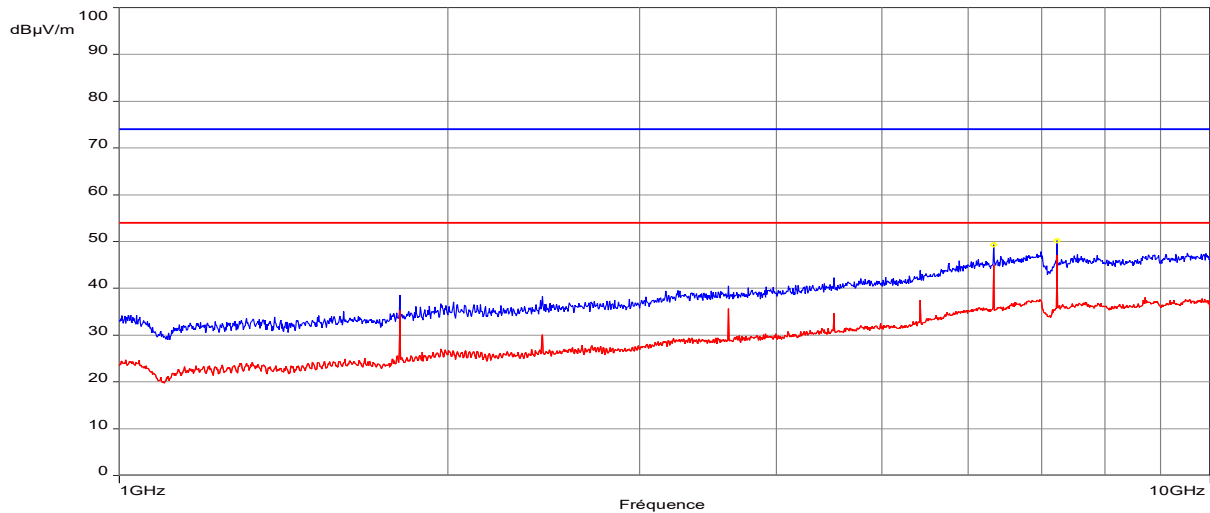
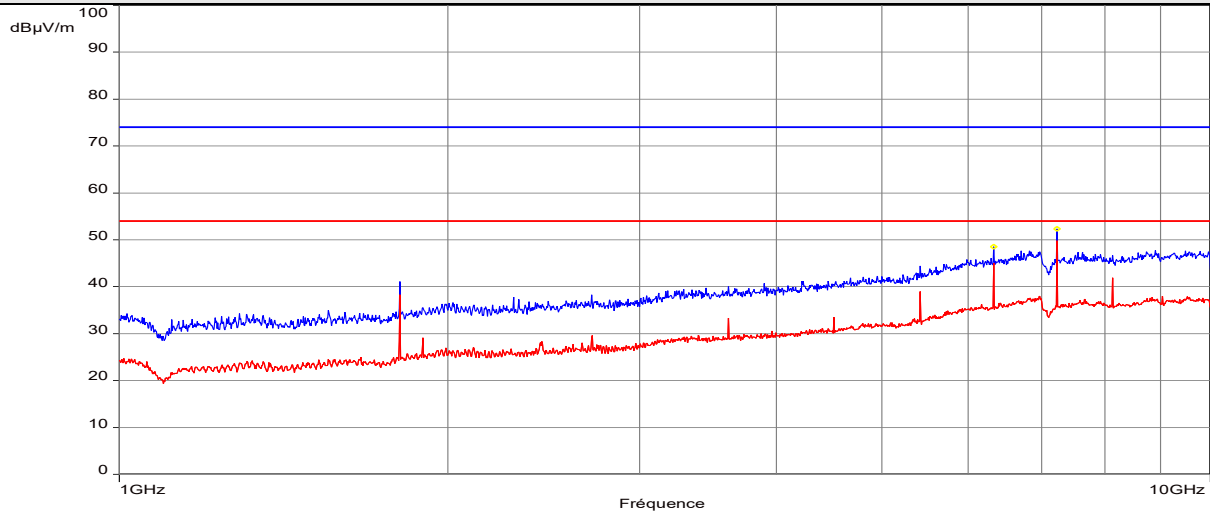

Note: Pre-scan graph only for identification purpose.

----- : Peak measure	----- : Average measure
<b>Frequency band investigated:</b>	1GHz-10GHz
<b>Unit :</b>	dBµV/m
<b>RBW :</b>	1MHz
<b>Antenna polarization :</b>	Horizontal & Vertical
<b>Limit:</b>	FCC 15.247 / RSS-247
<b>Measurement detector:</b>	Peak / Average

### PEAK LIST FROM PRE-SCAN

Frequency (MHz)	Peak Level (dBµV/m)	Angle (°)	Average Limit (dBµV/m)	Polarization	Comments
6327.04	48.58	125.4	54.0	H	-
7231.01	52.33	57	54.0	H	-
6327.6	49.28	182.8	54.0	V	-
7231.29	50.19	182.8	54.0	V	-

## Graphical representation of Radiated Disturbance Measurement (Anechoic chamber pre-scan, 1GHz-10GHz / 3m / Horizontal & Vertical) – High channel / Lora mode / Antenna #1

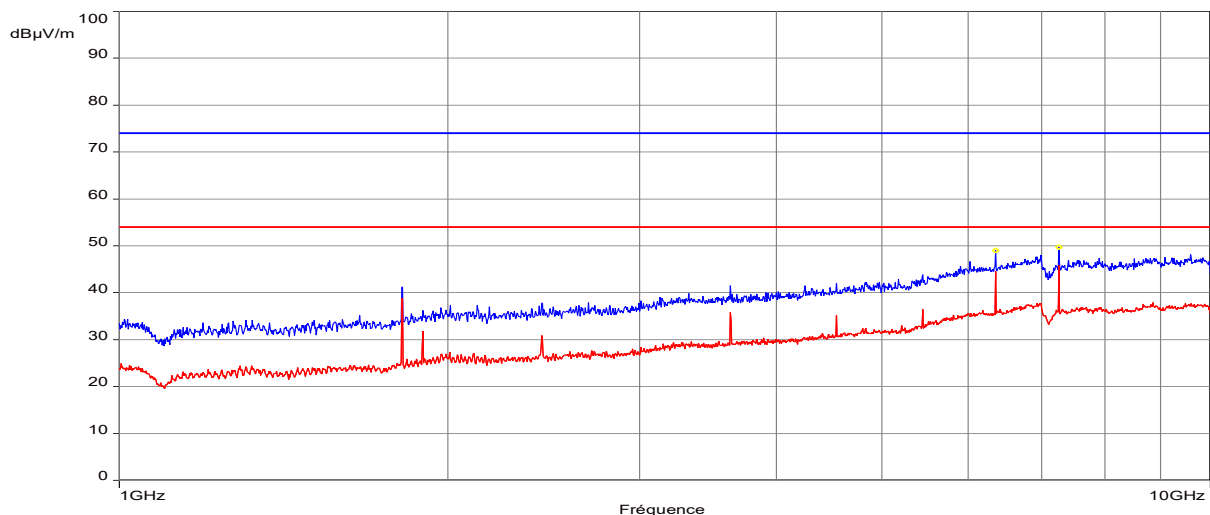
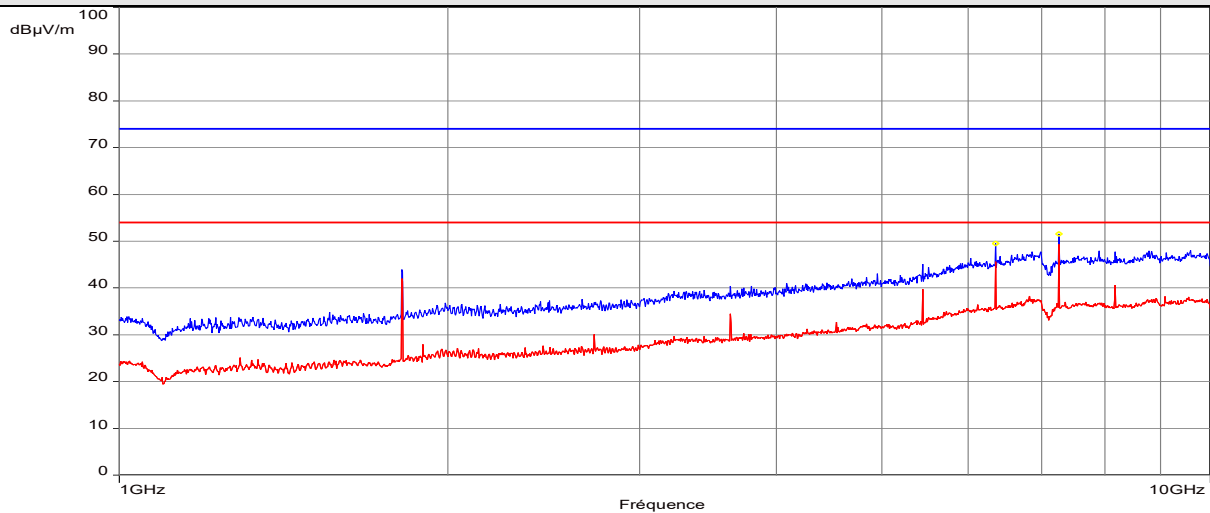

Note: Pre-scan graph only for identification purpose.

----- : Peak measure	----- : Average measure
<b>Frequency band investigated:</b>	1GHz-10GHz
<b>Unit :</b>	dBµV/m
<b>RBW :</b>	1MHz
<b>Antenna polarization :</b>	Horizontal & Vertical
<b>Limit:</b>	FCC 15.247 / RSS-247
<b>Measurement detector:</b>	Peak / Average

### PEAK LIST FROM PRE-SCAN

Frequency (MHz)	Peak Level (dBµV/m)	Angle (°)	Average Limit (dBµV/m)	Polarization	Comments
6357.98	49.47	139.3	54.0	H	-
7266.73	51.59	153	54.0	H	-
6358.26	49.06	151.1	54.0	V	-
7266.73	49.71	206	54.0	V	-

## Graphical representation of Radiated Disturbance Measurement (Anechoic chamber pre-scan, 1GHz-10GHz / 3m / Horizontal & Vertical) – Low channel / FSK mode / Antenna #1

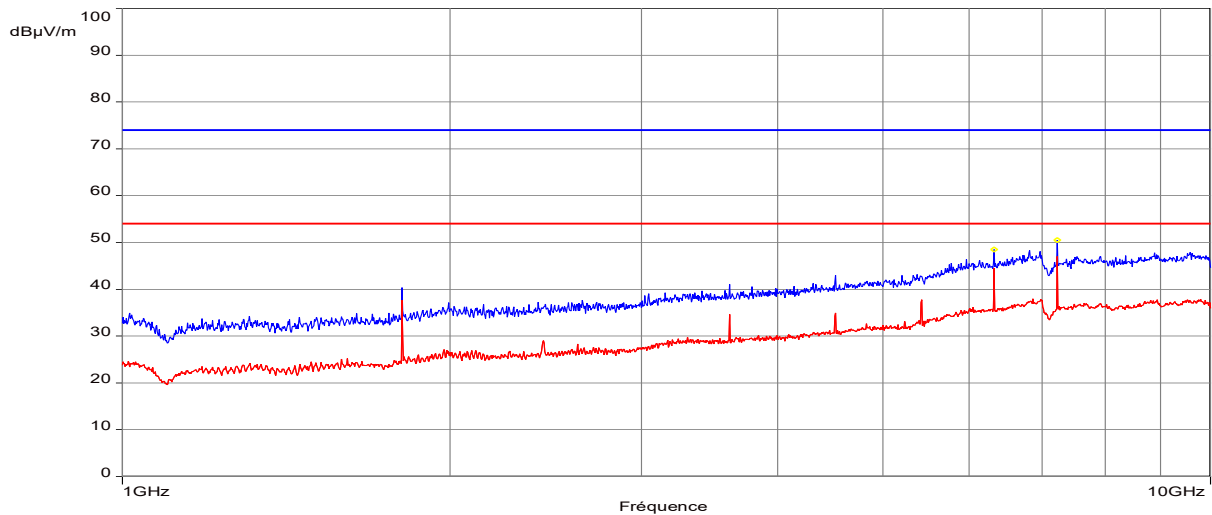
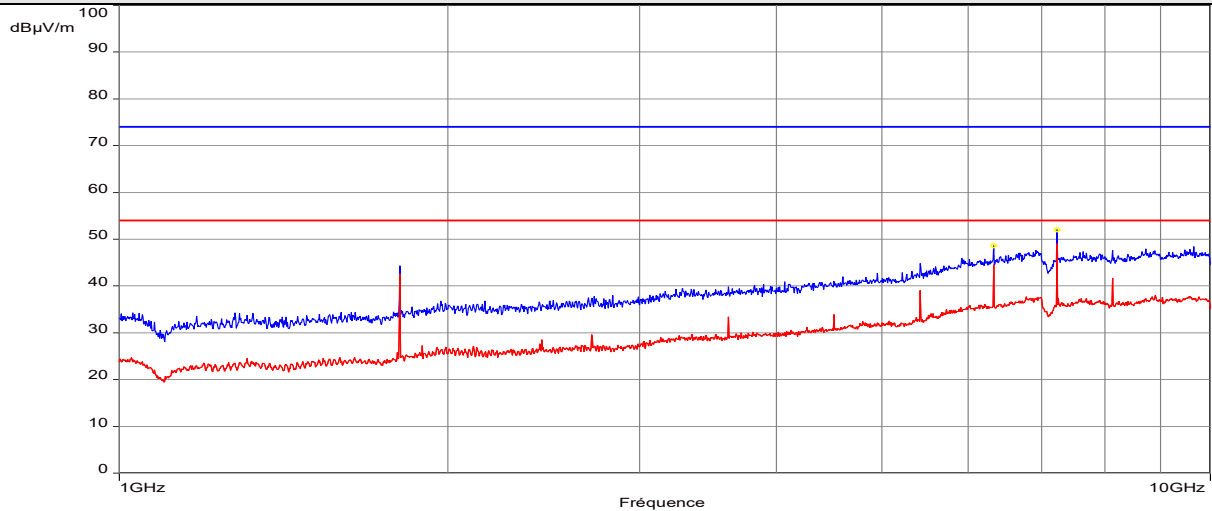

Note: Pre-scan graph only for identification purpose.

----- : Peak measure	----- : Average measure
<b>Frequency band investigated:</b>	1GHz-10GHz
<b>Unit :</b>	dBµV/m
<b>RBW :</b>	1MHz
<b>Antenna polarization :</b>	Horizontal & Vertical
<b>Limit:</b>	FCC 15.247 / RSS-247
<b>Measurement detector:</b>	Peak / Average

### PEAK LIST FROM PRE-SCAN

Frequency (MHz)	Peak Level (dBµV/m)	Angle (°)	Average Limit (dBµV/m)	Polarization	Comments
6326.76	48.68	83.2	54.0	H	-
7231.85	52.02	110.6	54.0	H	-
6326.76	48.68	83.2	54.0	V	-
7231.85	52.02	110.6	54.0	V	-

## Graphical representation of Radiated Disturbance Measurement (Anechoic chamber pre-scan, 1GHz-10GHz / 3m / Horizontal & Vertical) – High channel / FSK mode / Antenna #1

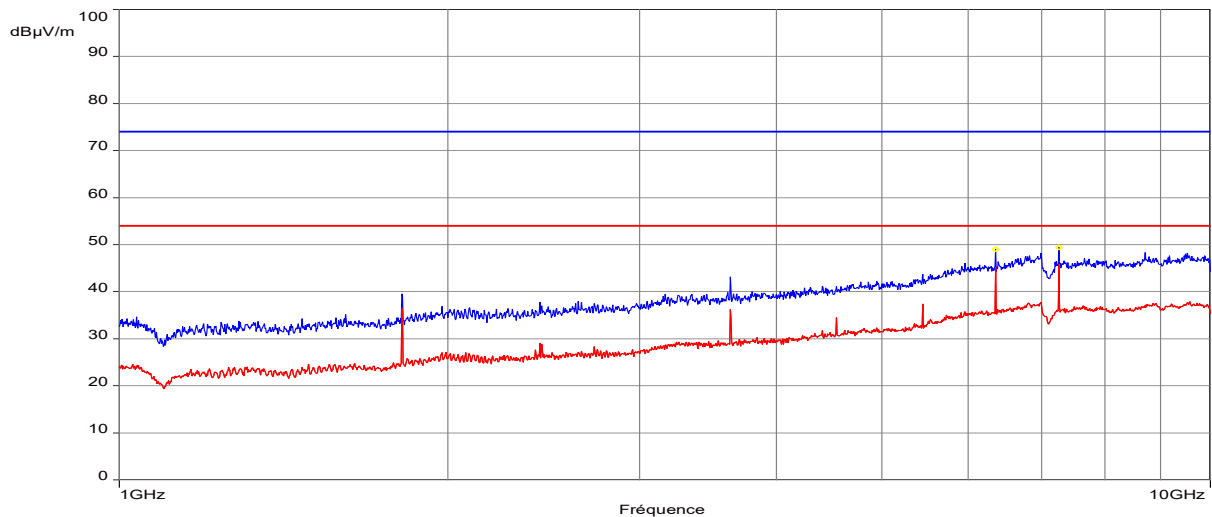
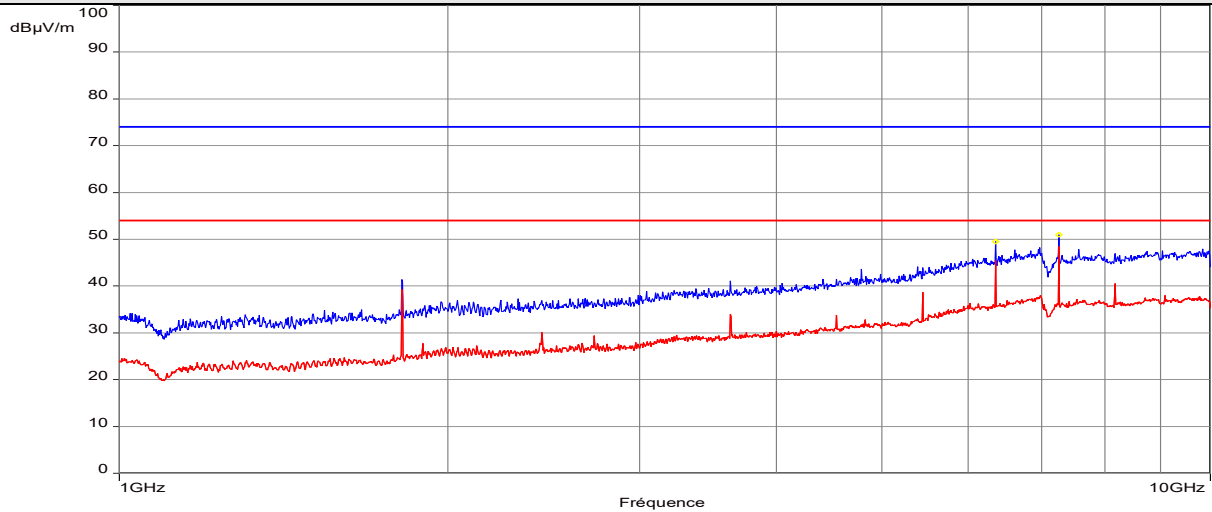

Note: Pre-scan graph only for identification purpose.

----- : Peak measure	----- : Average measure
<b>Frequency band investigated:</b>	1GHz-10GHz
<b>Unit :</b>	dBµV/m
<b>RBW :</b>	1MHz
<b>Antenna polarization :</b>	Horizontal & Vertical
<b>Limit:</b>	FCC 15.247 / RSS-247
<b>Measurement detector:</b>	Peak / Average

### PEAK LIST FROM PRE-SCAN

Frequency (MHz)	Peak Level (dBµV/m)	Angle (°)	Average Limit (dBµV/m)	Polarization	Comments
6358.54	49.52	69.2	54.0	H	-
7265.88	51.01	69.2	54.0	H	-
6358.26	48.99	154.1	54.0	V	-
7267.01	49.45	207.9	54.0	V	-

## Graphical representation of Radiated Disturbance Measurement (Anechoic chamber pre-scan, 1GHz-10GHz / 3m / Horizontal & Vertical) – Mid channel / Antenna #2

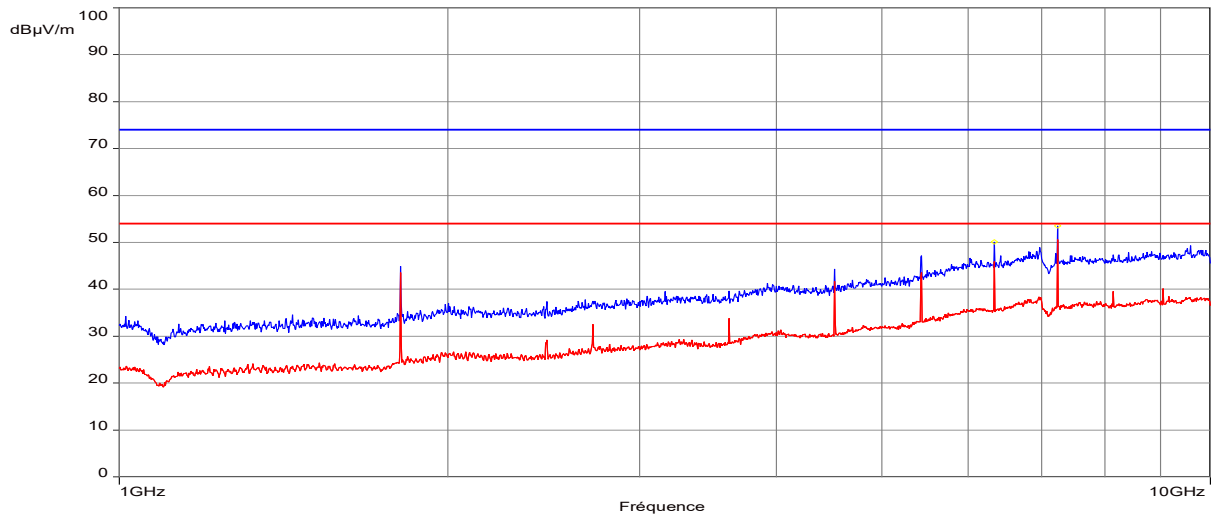
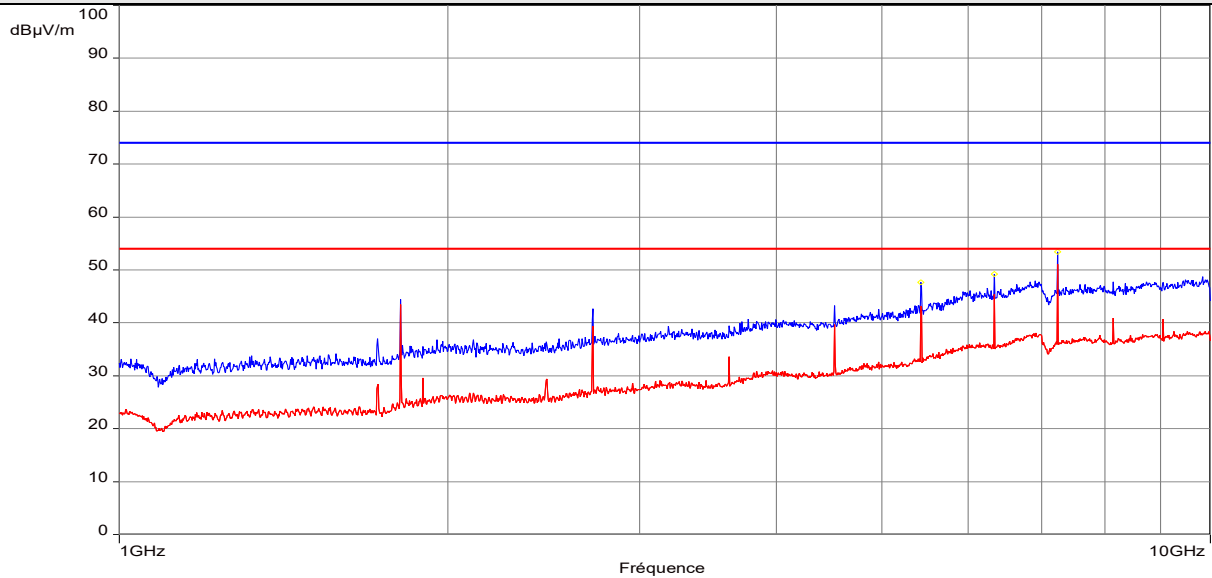

Note: Pre-scan graph only for identification purpose.  
Same results for LORA/ FSK mode.

----- : Peak measure	----- : Average measure
<b>Frequency band investigated:</b>	1GHz-10GHz
<b>Unit :</b>	dBµV/m
<b>RBW :</b>	1MHz
<b>Antenna polarization :</b>	Horizontal & Vertical
<b>Limit:</b>	FCC 15.247 / RSS-247
<b>Measurement detector:</b>	Peak / Average

### PEAK LIST FROM PRE-SCAN

Frequency (MHz)	Peak Level (dBµV/m)	Angle (°)	Average Limit (dBµV/m)	Polarization	Comments
6337.45	50.08	127.5	54.0	H	-
7242.82	53.51	93.7	54.0	H	-
6336.6	49.25	176.3	54.0	V	-
7242.82	53.44	159.3	54.0	V	-



**18. Occupied bandwidth (99%)**

TEST: Occupied bandwidth (99%) / RSS-GEN		Verdict					
<p><u>Method:</u> The setup is in an anechoic chamber. The spectrum analyzer is connected to the measuring antenna. A radiated measurement is performed.            The RBW is set in the range of 1% to 5% of the occupied bandwidth, with VBW ≥ 3 x RBW.            The SPAN is wide enough to capture all products of the modulation process.            A Sample detector is used.            Measure is performed with OBW 99% function of the spectrum analyser.            The tested equipment is set to transmit operation with modulation on low and high channels for both bands.</p>		<b>Pass</b>					
Laboratory Parameters:	<table border="1" style="width: 100%; border-collapse: collapse;"> <thead> <tr> <th style="width: 33%;">Required prior to the test</th> <th style="width: 33%;">During the test</th> </tr> </thead> <tbody> <tr> <td>Ambient Temperature</td> <td>20 to 30 °C</td> </tr> <tr> <td>Relative Humidity</td> <td>25 to 70 %</td> </tr> </tbody> </table>		Required prior to the test	During the test	Ambient Temperature	20 to 30 °C	Relative Humidity
Required prior to the test	During the test						
Ambient Temperature	20 to 30 °C						
Relative Humidity	25 to 70 %						
Supplementary information: Test location: SMEE. Test date: December 13 <sup>th</sup> , 2018. Tested by L. CHAPUS							

Test Equipment Used					
Description	Manufacturer	Model	Identifier	Cal. Date	Cal. Due
Attenuator	Mini-Circuit	BW-N10W5+	ATT-171-008	2018/4	2019/4
Measuring receiver	Rohde&Schwarz	ESRP	REC-151-003	2017/5	2019/5

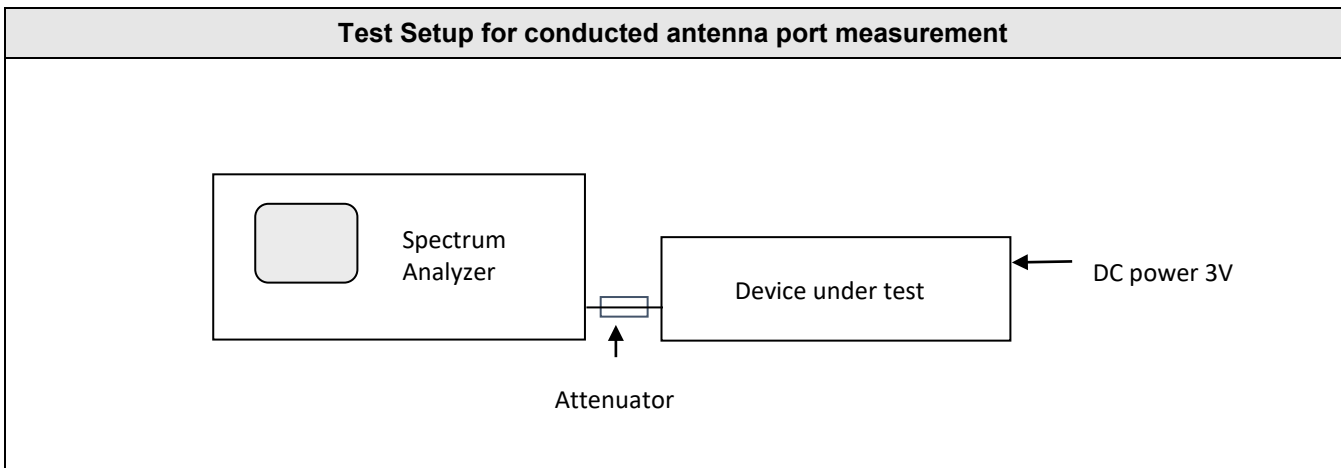

## Tabulated Results for Occupied Bandwidth

Frequency (MHz)	99% Occupied Bandwidth (kHz)
903.9 / LORA-B1	130.6
905.3 / LORA-B1	131.7
906.9 / LORA-B2	130.5
908.3 / LORA-B2	130.2
903.9 / FSK-B1	171.5
905.3 / FSK-B1	171.6
906.9 / FSK-B2	171.5
908.3 / FSK-B2	171.4

## Graphical representation of Occupied Bandwidth

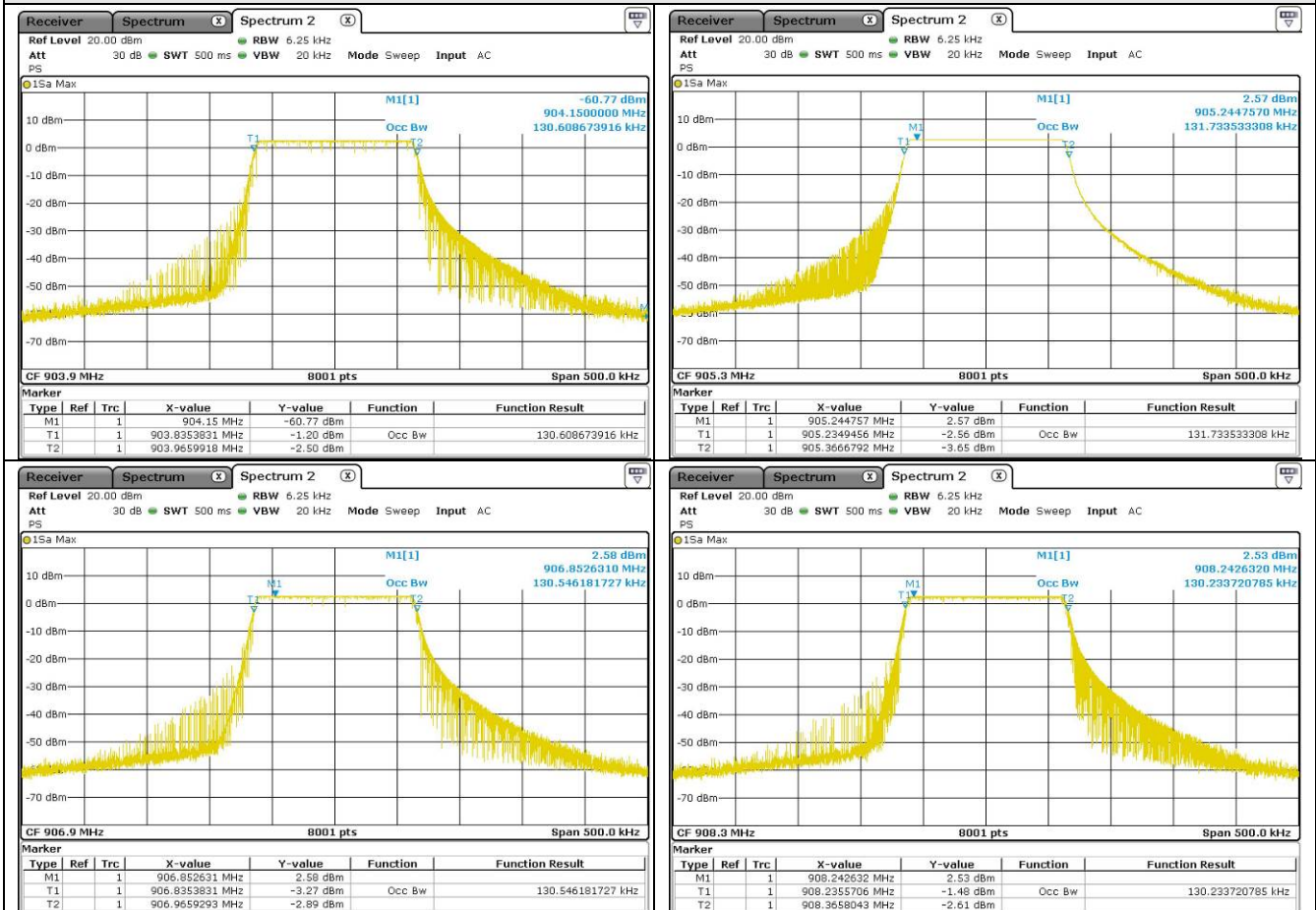

## Graphical representation of Occupied Bandwidth

