

# TEST REPORT

of

FCC Part 15 Subpart C §15.249

FCC ID: 2ARYQPROXIMITY

Equipment Under Test : CUBROID PROXIMITY SENSOR BLOCK  
Model Name : CUBROID PROXIMITY SENSOR BLOCK  
Applicant : CUBROID, INC.  
Manufacturer : WEIHAI SHUOKE MICROMOTOR CO.,LTD.  
Date of Receipt : 2018.08.07  
Date of Test(s) : 2018.11.23 ~ 2018.12.17  
Date of Issue : 2019.01.29

In the configuration tested, the EUT complied with the standards specified above.

Tested By:



Date:

2019.01.29

Jinhyoung Cho

Technical  
Manager:

Date:

2019.01.29

Hyunchoe You

*The results shown in this test report refer only to the sample(s) tested unless otherwise stated. This test report cannot be reproduced, except in full, without prior written permission of the Company. This test report does not assure KOLAS accreditation.*

# INDEX

<u>Table of Contents</u>	Page
1. General information -----	3
2. Fundamental and Radiated Spurious Emission-----	7
3. 20 dB Bandwidth -----	27
4. AC Power Line Conducted Emission -----	31
5. Antenna Requirement -----	35

*The results shown in this test report refer only to the sample(s) tested unless otherwise stated. This test report cannot be reproduced, except in full, without prior written permission of the Company. This test report does not assure KOLAS accreditation.*

**SGS Korea Co., Ltd. (Gunpo Laboratory)** 4, LS-ro 182beon-gil, Gunpo-si, Gyeonggi-do, Korea, 15807 <http://www.sgsgroup.kr>

## 1. General information

### 1.1. Testing Laboratory

SGS Korea Co., Ltd. (Gunpo Laboratory)

- Wireless Div. 2FL, 10-2, LS-ro 182beon-gil, Gunpo-si, Gyeonggi-do, Korea, 15807
- Designation number: KR0150

All SGS services are rendered in accordance with the applicable SGS conditions of service available on request and accessible at <http://www.sgs.com/en/Terms-and-Conditions.aspx>.

Phone No. : +82 31 688 0901

Fax No. : +82 31 688 0921

### 1.2. Details of Applicant

Applicant : CUBROID, INC.  
 Address : A-dong, 12F, 660, Daewangpangyo-ro, Bundang-gu, Seongnam-si, South Korea  
 Contact Person : Shin, Jae-kwang  
 Phone No. : +82 70 7005 9296

### 1.3. Details of Manufacturer

Applicant : WEIHAI SHUOKE MICROMOTOR CO., LTD.  
 Address : NO.150 QIAOSHUN ROAD, CHANLI VILLAGE, QIAOTOU TOWN, ECONOMIC AND TECHNOLOGIAL DEVELOPMENT ZONE, WEIHAI-CITY, SHANDONG-PROVICNE, CHINA

### 1.4. Description of EUT

<b>Kind of Product</b>	CUBROID PROXIMITY BLOCK
<b>Model Name</b>	CUBROID PROXIMITY BLOCK
<b>Approved Module Name</b>	EH-MC10 (FCC ID: 2ACCRMC10)
<b>Power Supply</b>	DC 3.7 V
<b>Frequency Range</b>	2 402 MHz ~ 2 480 MHz
<b>Modulation Technique</b>	GFSK
<b>Number of Channels</b>	40 channels
<b>Antenna Type</b>	Chip Antenna
<b>Antenna Gain</b>	0 dBi

*The results shown in this test report refer only to the sample(s) tested unless otherwise stated. This test report cannot be reproduced, except in full, without prior written permission of the Company. This test report does not assure KOLAS accreditation.*

**SGS Korea Co., Ltd. (Gunpo Laboratory)** 4, LS-ro 182beon-gil, Gunpo-si, Gyeonggi-do, Korea, 15807 <http://www.sgsgroup.kr>

## 1.5. Test Equipment List

Equipment	Manufacturer	Model	S/N	Cal. Date	Cal. Interval	Cal. Due
Signal Generator	R&S	SMBV100A	259067	Jun. 15, 2018	Annual	Jun. 15, 2019
Signal Generator	Agilent	E8257D	MY51501169	Jul. 03, 2018	Annual	Jul. 03, 2019
Spectrum Analyzer	Agilent	N9020A	MY53421758	Sep. 21, 2018	Annual	Sep. 21, 2019
Spectrum Analyzer	R&S	FSV30	100768	Mar. 12, 2018	Annual	Mar. 12, 2019
High Pass Filter	Wainwright Instrument GmbH	WHK3.0/18G-10SS	344	May 27, 2018	Annual	May 27, 2019
Low Pass Filter	Mini-Circuits	NLP-1200+	V8979400903-2	Feb. 22, 2018	Annual	Feb. 22, 2019
DC Power Supply	R&S	HMP2020	020089489	May 30, 2018	Annual	May 30, 2019
Preamplifier	H.P.	8447F	2944A03909	Aug. 07, 2018	Annual	Aug. 07, 2019
Signal Conditioning Unit	R&S	SCU-18	10117	Aug. 07, 2018	Annual	Aug. 07, 2019
Loop Antenna	Schwarzbeck Mess-Elektronik	FMZB 1519	1519-039	Aug. 23, 2017	Biennial	Aug. 23, 2019
Bilog Antenna	Schwarzbeck Mess-Elektronik	VULB 9163	01126	Mar. 26, 2018	Biennial	Mar. 26, 2020
Horn Antenna	R&S	HF906	100326	Feb. 14, 2018	Biennial	Feb. 14, 2020
Horn Antenna	Schwarzbeck Mess-Elektronik	BBHA 9170	9170-540	Jul. 17, 2017	Biennial	Jul. 17, 2019
Horn Antenna	Schwarzbeck Mess-Elektronik	BBHA 9170	BBHA9170223	Sep. 10, 2018	Biennial	Sep. 10, 2020
Turn Table	INN-CO systems	CONTROLLER CO3000	N/A	N. C. R	N/A	N. C. R
Antenna Master	INN-CO systems	MA4640-XP-ET	N/A	N. C. R	N/A	N. C. R
Test Receiver	R&S	ESU26	100109	Jan. 07, 2018	Annual	Jan. 07, 2019
Anechoic Chamber	SY Corporation	L x W x H (9.6 m x 6.4 m x 6.6 m)	N/A	N.C.R.	N/A	N.C.R.
Two-Line V-Network	R&S	ENV216	100190	May 14, 2018	Annual	May 14, 2019
Test Receiver	R&S	ESIB 7	100253	Feb. 23, 2018	Annual	Feb. 23, 2019
Shield Room	SY Corporation	L x W x H (6.5 m x 3.5 m x 3.5 m)	N/A	N.C.R.	N/A	N.C.R.
Coaxial Cable	SUCOFLEX	104 (3 m)	MY3258414	Jul. 04, 2018	Semi-annual	Jan. 04, 2019
Coaxial Cable	SUCOFLEX	104 (10 m)	MY3145814	Jul. 04, 2018	Semi-annual	Jan. 04, 2019

### ► Support equipment

Description	Manufacturer	Information
AC/DC adaptor	Samsung Electronics Co., Ltd.	-
USB Cable	DONGGUAN LESHU ELECTROIC & TECHNOLOLOGY Co., Ltd.	Length: 50 cm, with shielding

The results shown in this test report refer only to the sample(s) tested unless otherwise stated. This test report cannot be reproduced, except in full, without prior written permission of the Company. This test report does not assure KOLAS accreditation.

## 1.6. Summary of Test Results

The EUT has been tested according to the following specifications:

Applied Standard: FCC Part15 Subpart C		
Section	Test Item	Result
15.205 15.209(a) 15.249(a) 15.249(c) 15.249(d)	Fundamental and Radiated Spurious Emission	Complied
15.215(c)	20 dB Bandwidth	Complied
15.207	AC Power Line Conducted Emissions	Complied

## 1.7. Test Procedure(s)

The measurement procedures described in the American National Standard of Procedure for Compliance Testing of unlicensed Wireless Devices (ANSI C63.10-2013) was used in the measurement of the DUT.

## 1.8. Sample Calculation

Where relevant, the following sample calculation is provided

### 1.8.1. Radiation Test

Field strength level (dB $\mu$ V/m) = Measured level (dB $\mu$ V) + Antenna factor (dB) + Cable loss (dB) - Amplifier gain (dB)

## 1.9. Measurement Uncertainty

Where relevant, the following measurement uncertainty levels have been estimated for tests performed on the apparatus:

Parameter	Uncertainty (dB)
Conducted Disturbance	± 3.30
Radiated Disturbance, 9 kHz to 30 MHz	± 3.59
Radiated Disturbance, below 1 GHz	± 5.88
Radiated Disturbance, above 1 GHz	± 5.94

Uncertainty figures are valid to a confidence level of 95 %.

*The results shown in this test report refer only to the sample(s) tested unless otherwise stated. This test report cannot be reproduced, except in full, without prior written permission of the Company. This test report does not assure KOLAS accreditation.*

### 1.10. Test Report Revision

Revision	Report number	Date of Issue	Description
0	F690501/RF-RTL013315	2018.12.19	Initial
1	F690501/RF-RTL013315-1	2019.01.29	Added Support equipment and Antenna Requirement

*The results shown in this test report refer only to the sample(s) tested unless otherwise stated. This test report cannot be reproduced, except in full, without prior written permission of the Company. This test report does not assure KOLAS accreditation.*

**SGS Korea Co., Ltd. (Gunpo Laboratory)** 4, LS-ro 182beon-gil, Gunpo-si, Gyeonggi-do, Korea, 15807 <http://www.sgsgroup.kr>

## 2. Fundamental and Radiated Spurious Emission

### 2.1. Test Setup

The diagram below shows the test setup that is utilized to make the measurements for emission from 9 kHz to 30 MHz Emissions.

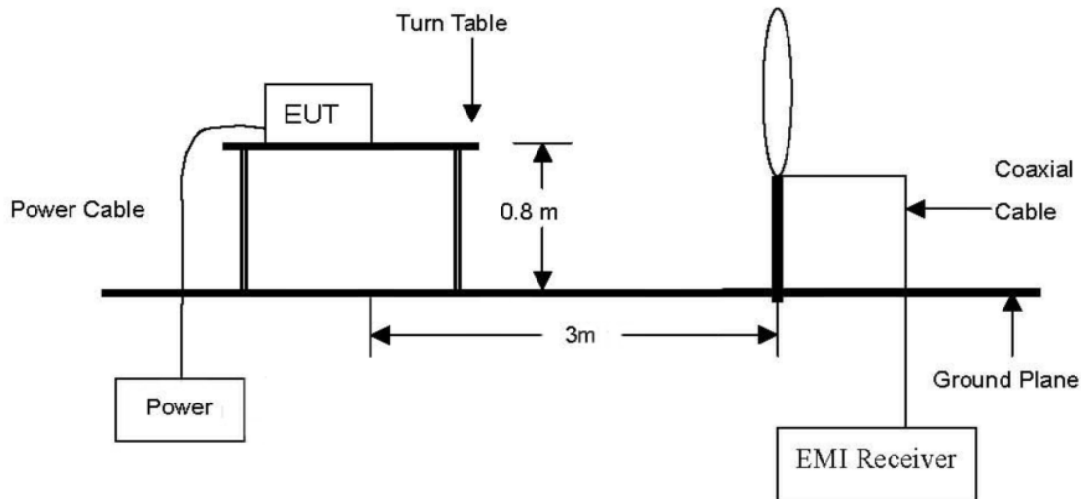

The diagram below shows the test setup that is utilized to make the measurements for emission from 30 MHz to 1 GHz Emissions.

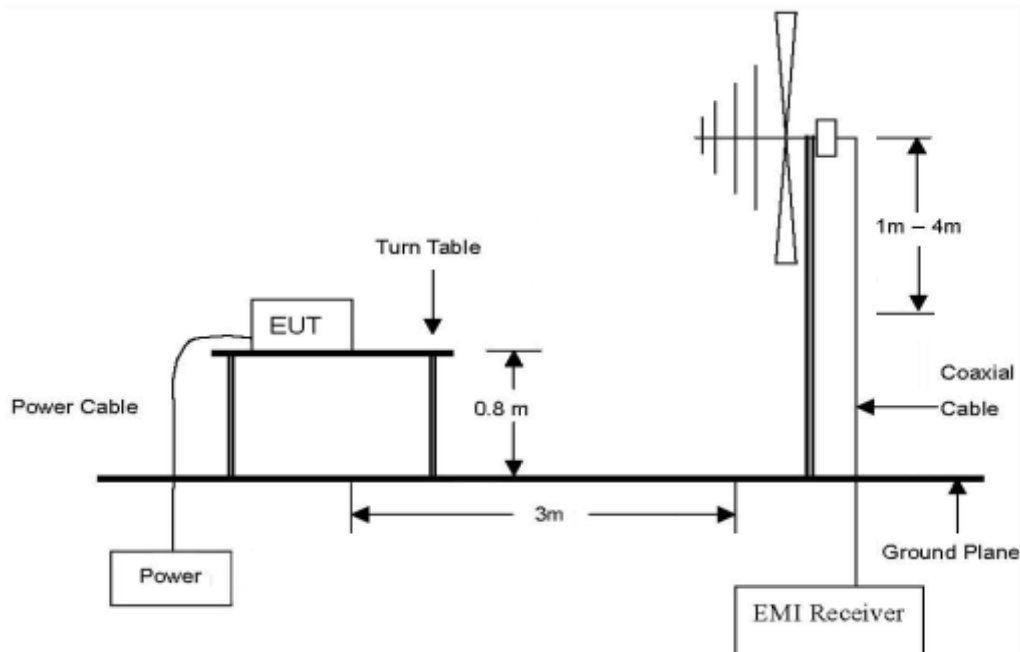

*The results shown in this test report refer only to the sample(s) tested unless otherwise stated. This test report cannot be reproduced, except in full, without prior written permission of the Company. This test report does not assure KOLAS accreditation.*

The diagram below shows the test setup that is utilized to make the measurements for emission. The spurious emissions were investigated from 1 GHz to the 10<sup>th</sup> harmonic of the highest fundamental frequency or 40 GHz, whichever is lower.

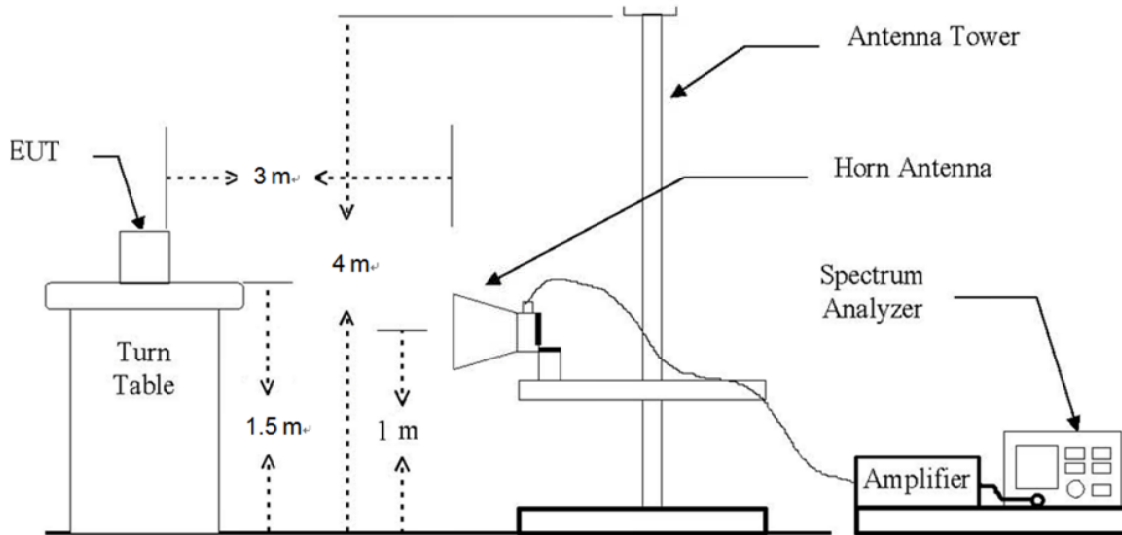

*The results shown in this test report refer only to the sample(s) tested unless otherwise stated. This test report cannot be reproduced, except in full, without prior written permission of the Company. This test report does not assure KOLAS accreditation.*



## 2.2. Limit

According to §15.249(a), Except as provided in paragraph (b) of this section, the field strength of emissions from intentional radiators operated within these frequency bands shall comply with the following:

Fundamental frequency	Field strength of fundamental (mV/m)	Field strength of harmonics (µV/m)
902-928 MHz	50	500
2 400-2 483.5 MHz	50	500
5 725-5 875 MHz	50	500
24.0-24.25 GHz	250	2 500

According to §15.249(d), Emissions radiated outside of the specified frequency bands, except for harmonics, shall be attenuated by at least 50 dB below the level of the fundamental or to the general radiated emission limits in §15.209, whichever the lesser attenuation.

According to §15.209(a), Except as provided elsewhere in this subpart, the emissions from an intentional radiator shall not exceed the field strength levels specified in the following table:

Frequency (MHz)	Field strength (µV/m)	Measurement distance (Meters)
0.009-0.490	2 400/F(kHz)	300
0.490-1.705	24 000/F(kHz)	30
1.705-30.0	30	30
30-88	100**	3
88-216	150**	3
216-960	200**	3
Above 960	500	3

\*\* Except as provided in paragraph (g), fundamental emissions from intentional radiators operating under this section shall not be located in the frequency bands 54-72 MHz, 76-88 MHz, 174-216 MHz or 470-806 MHz. However, operation within these frequency bands is permitted under other sections of this part, e.g., §§15.231 and 15.241.

*The results shown in this test report refer only to the sample(s) tested unless otherwise stated. This test report cannot be reproduced, except in full, without prior written permission of the Company. This test report does not assure KOLAS accreditation.*

## 2.3. Test Procedures

Radiated emissions from the EUT were measured according to the dictates of ANSI C63.10-2013.

### 2.3.1. Test procedures for emission below 30 MHz

1. The EUT was placed on the top of a rotating table 0.8 meters above the ground at a 3 meter anechoic chamber test site. The table was rotated 360 degrees to determine the position of the highest radiation.
2. Then antenna is a loop antenna is fixed at one meter above the ground to determine the maximum value of the field strength. Both parallel and perpendicular of the antenna are set to make the measurement.
3. For each suspected emission, the EUT was arranged to its worst case and then the table was turned from 0 degrees to 360 degrees to find the maximum reading.
4. The test-receiver system was set to average or quasi peak detect function and Specified Bandwidth with Maximum Hold Mode.

### 2.3.2. Test procedures for emission above 30 MHz

1. The EUT was placed on the top of a rotating table 0.8 meters above the ground at a 3 meter anechoic chamber test site below 1 GHz and 1.5 meters above the ground at a 3 meter anechoic chamber test site above 1 GHz. The table was rotated 360 degrees to determine the position of the highest radiation.
2. During performing radiated emission below 1 GHz, the EUT was set 3 meters away from the interference receiving antenna, which was mounted on the top of a variable-height antenna tower. During performing radiated emission above 1 GHz, the EUT was set 3 meter away from the interference-receiving antenna.
3. The antenna is a bi-log antenna, a horn antenna and its height is varied from one meter to four meters above the ground to determine the maximum value of the field strength. Both horizontal and vertical polarizations of the antenna are set to make the measurement.
4. For each suspected emission, the EUT was arranged to its worst case and then the antenna was tuned to heights from 1 meter to 4 meters and the table was turned from 0 degrees to 360 degrees to find the maximum reading.
5. The test-receiver system was set to Peak Detect Function and Specified Bandwidth with Maximum Hold Mode.
6. If the emission level of the EUT in peak mode was 10 dB lower than the limit specified, then testing could be stopped and the peak values of the EUT would be reported. Otherwise the emissions that did not have 10 dB margin would be re-tested one by one using peak, quasi-peak or average method as specified and then reported in a data sheet.

#### Note;

1. For frequency below 1 GHz, set spectrum analyzer detector to peak, and resolution bandwidth is 100 kHz and video bandwidth is 300 kHz.
2. For frequency above 1 GHz, set spectrum analyzer detector to peak, and resolution bandwidth is 1 MHz and video bandwidth is 3 MHz.
3. To get a maximum emission level from the EUT, the EUT is manipulated through three orthogonal planes (X, Y, Z). Worst orthogonal plan of EUT is Y – axis during radiation test.

*The results shown in this test report refer only to the sample(s) tested unless otherwise stated. This test report cannot be reproduced, except in full, without prior written permission of the Company. This test report does not assure KOLAS accreditation.*

## 2.4. Test result

Ambient temperature : (23 ± 1) °C  
 Relative humidity : 47 % R.H.

### 2.4.1. Field Strength of Fundamental

The following table shows the highest levels of radiated emissions on both polarizations of horizontal and vertical.

Frequency (MHz)	Detect Mode	Ant. Pol.	Reading (dB $\mu$ V)	AF (dB/m)	CL (dB)	Result (dB $\mu$ V/m)	Limit (dB $\mu$ V/m)	Margin (dB)
<Low channel 2 402 MHz>								
2 402.22	Peak	H	53.15	28.00	7.73	88.88	114.00	25.12
2 402.04	Average	H	49.73	28.00	7.72	85.45	94.00	8.55
<Middle channel 2 440 MHz>								
2 440.24	Peak	H	55.77	28.00	7.80	91.57	114.00	22.43
2 440.10	Average	H	53.02	28.00	7.80	88.82	94.00	5.18
<High channel 2 480 MHz>								
2 479.74	Peak	H	58.51	28.00	7.83	94.34	114.00	19.66
2 480.00	Average	H	55.38	28.00	7.83	91.21	94.00	2.79

#### Remark;

1. Result = Reading + AF + CL

*The results shown in this test report refer only to the sample(s) tested unless otherwise stated. This test report cannot be reproduced, except in full, without prior written permission of the Company. This test report does not assure KOLAS accreditation.*

**SGS Korea Co., Ltd. (Gunpo Laboratory)** 4, LS-ro 182beon-gil, Gunpo-si, Gyeonggi-do, Korea, 15807 <http://www.sgsgroup.kr>

**- Test plots**

Low channel fundamental (Peak)

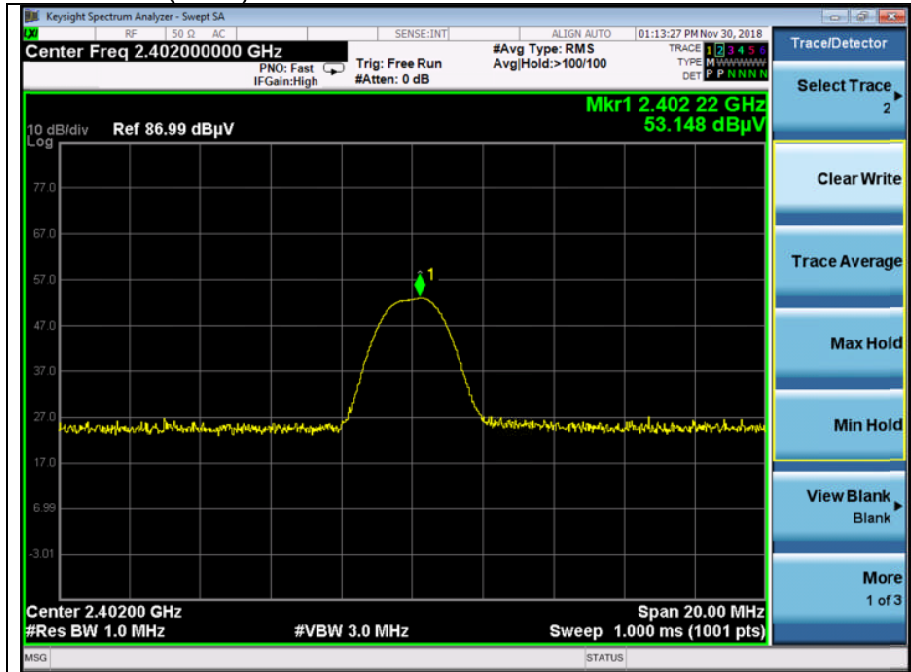

Low channel fundamental (Average)

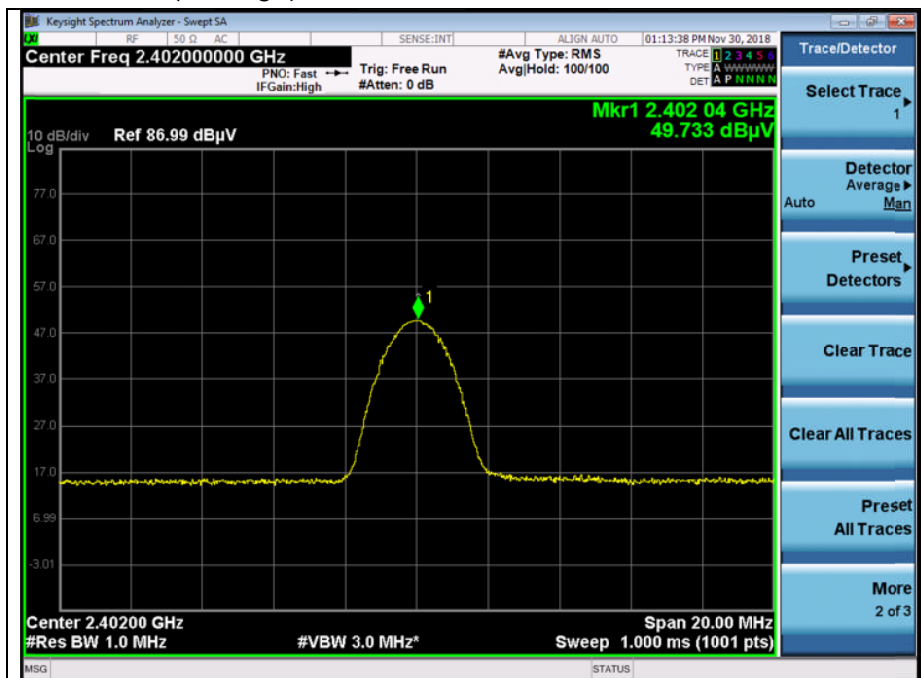

The results shown in this test report refer only to the sample(s) tested unless otherwise stated. This test report cannot be reproduced, except in full, without prior written permission of the Company. This test report does not assure KOLAS accreditation.

Middle channel fundamental (Peak)

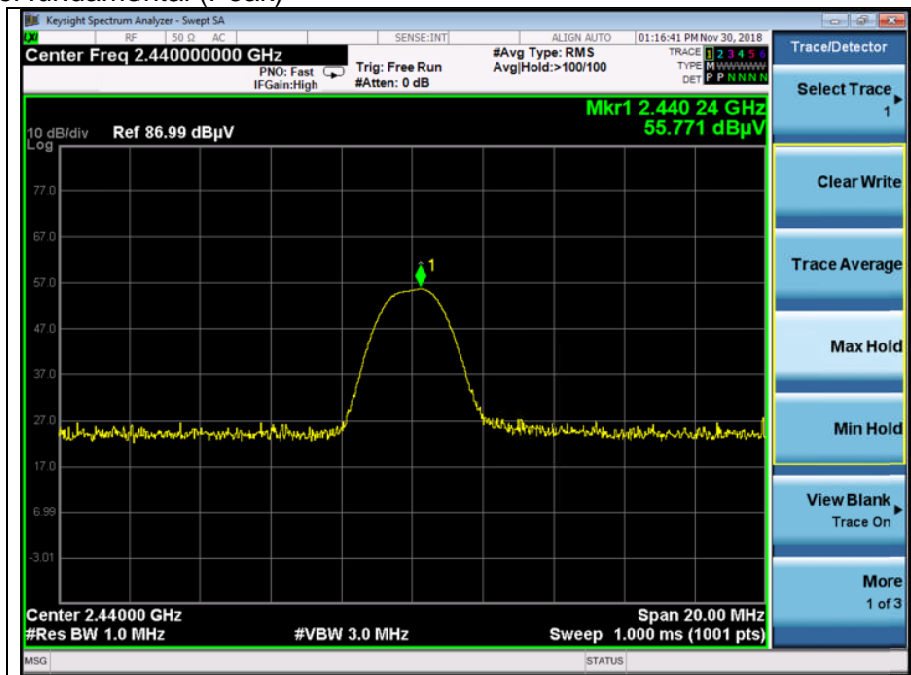

Middle channel fundamental (Average)

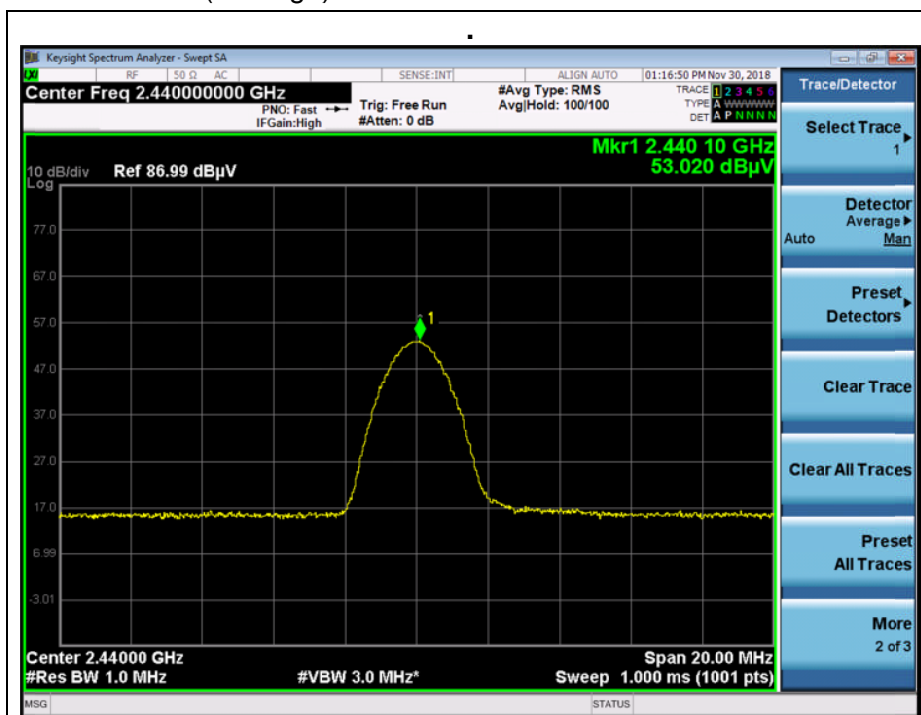

The results shown in this test report refer only to the sample(s) tested unless otherwise stated. This test report cannot be reproduced, except in full, without prior written permission of the Company. This test report does not assure KOLAS accreditation.

### High channel fundamental (Peak)

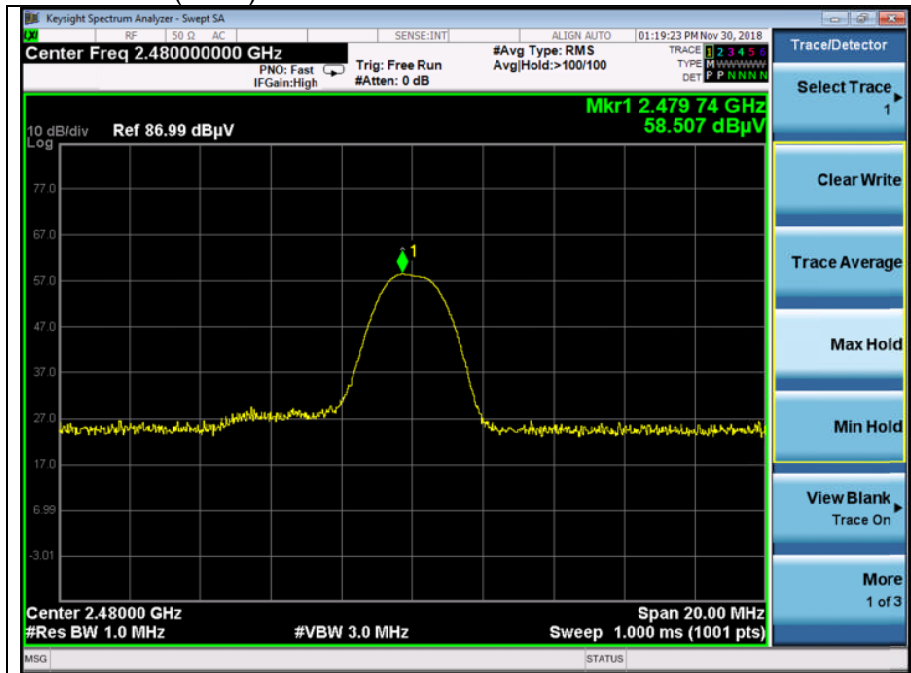

### High channel fundamental (Average)

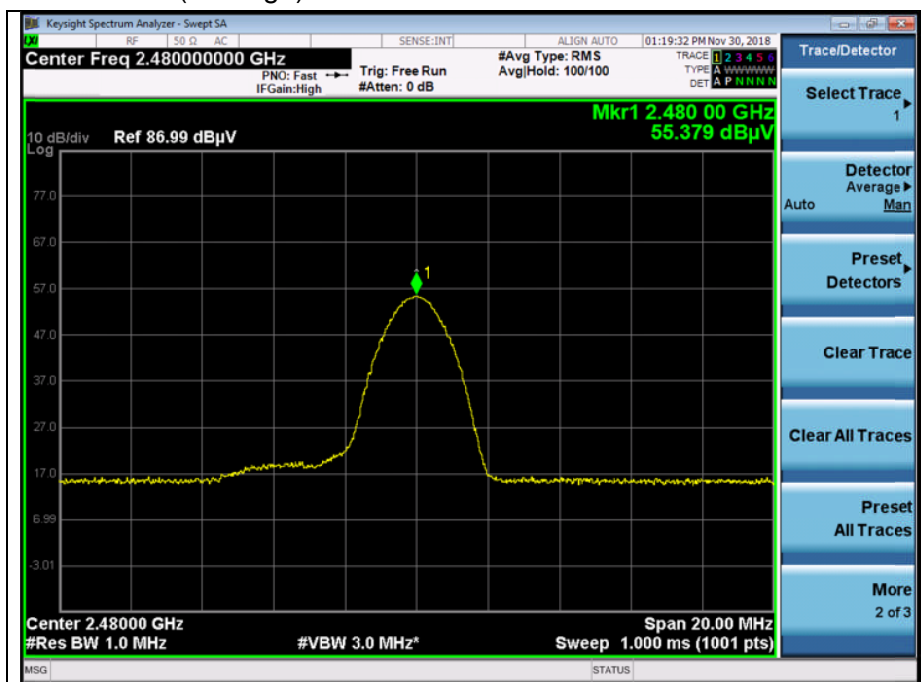

The results shown in this test report refer only to the sample(s) tested unless otherwise stated. This test report cannot be reproduced, except in full, without prior written permission of the Company. This test report does not assure KOLAS accreditation.

### 2.4.2. Radiated Spurious Emission below 1 000 MHz

The frequency spectrum from 9 kHz to 1 000 MHz was investigated. All reading values are peak values.

Radiated Emissions			Ant.	Correction Factors		Total	Limit	
Frequency (MHz)	Reading (dB $\mu$ V)	Detect Mode	Pol.	AF (dB/m)	AMP + CL (dB)	Actual (dB $\mu$ V/m)	Limit (dB $\mu$ V/m)	Margin (dB)
51.06	33.30	Peak	H	14.25	-26.51	21.04	40.00	18.96
423.17	34.90	Peak	H	16.33	-25.08	26.15	46.00	19.85
499.68	35.90	Peak	V	17.30	-24.77	28.43	46.00	17.57
905.06	34.40	Peak	V	22.40	-22.81	33.99	46.00	12.01

**Remark;**

1. Spurious emissions for all channels were investigated and almost the same below 1 GHz.
2. Reported spurious emissions are in **High channel** as worst case among other channels.
3. Radiated spurious emission measurement as below.  
(Actual = Reading + AF + AMP + CL)
4. According to §15.31(o), emission levels are not report much lower than the limits by over 20 dB.

**- Test plot**

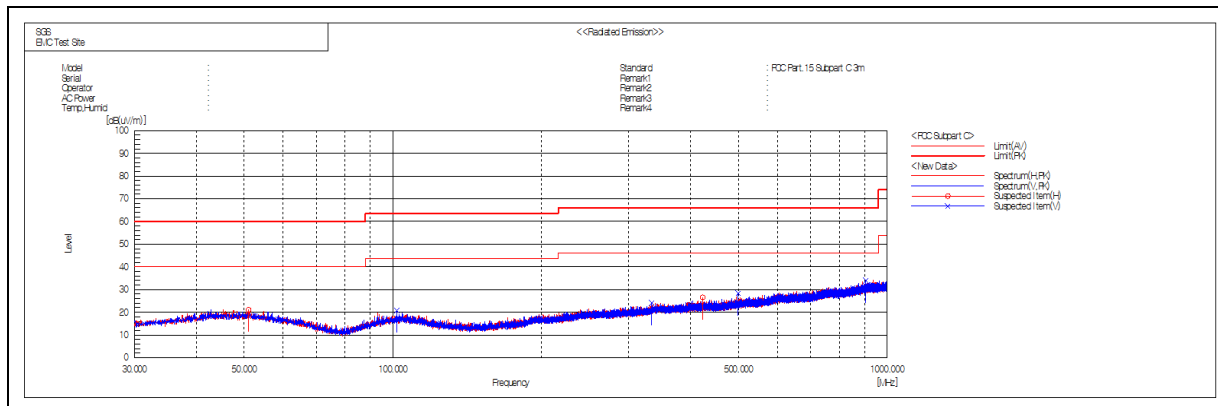

The results shown in this test report refer only to the sample(s) tested unless otherwise stated. This test report cannot be reproduced, except in full, without prior written permission of the Company. This test report does not assure KOLAS accreditation.

### 2.4.3. Radiated Band edge Emission and Spurious Emission above 1 000 MHz

#### A. Low Channel (2 402 MHz)

Radiated Emissions			Ant.	Correction Factors		Total	Limit	
Frequency (MHz)	Reading (dB $\mu$ V)	Detect Mode	Pol.	AF (dB/m)	CL (dB)	Actual (dB $\mu$ V/m)	Limit (dB $\mu$ V/m)	Margin (dB)
*2 310.00	13.99	Peak	H	27.82	7.54	49.35	74.00	24.65
*2 310.00	3.67	Average	H	27.82	7.54	39.03	54.00	14.97
*2 386.57	16.43	Peak	H	27.97	7.68	52.08	74.00	21.92
*2 379.42	4.46	Average	H	27.96	7.66	40.08	54.00	13.92
*2 390.00	13.61	Peak	H	27.98	7.69	49.28	74.00	24.72
*2 390.00	3.84	Average	H	27.98	7.69	39.51	54.00	14.49

Radiated Emissions			Ant.	Correction Factors		Total	Limit	
Frequency (MHz)	Reading (dB $\mu$ V)	Detect Mode	Pol.	AF (dB/m)	AMP+CL (dB)	Actual (dB $\mu$ V/m)	Limit (dB $\mu$ V/m)	Margin (dB)
*4 804.44	43.96	Peak	H	32.43	-32.79	43.60	74.00	30.40
*4 804.26	36.42	Average	H	32.43	-32.79	36.06	54.00	17.94
7 206.76	41.90	Peak	H	35.61	-29.42	48.09	74.00	25.91
7 205.40	32.55	Average	H	35.61	-29.43	38.73	54.00	15.27
Above 7 300.00	Not detected	-	-	-	-	-	-	-

The results shown in this test report refer only to the sample(s) tested unless otherwise stated. This test report cannot be reproduced, except in full, without prior written permission of the Company. This test report does not assure KOLAS accreditation.



## B. Middle Channel (2 440 MHz)

Radiated Emissions			Ant.	Correction Factors		Total	Limit	
Frequency (MHz)	Reading (dB $\mu$ V)	Detect Mode	Pol.	AF (dB/m)	AMP+CL (dB)	Actual (dB $\mu$ V/m)	Limit (dB $\mu$ V/m)	Margin (dB)
*4 880.48	47.16	Peak	H	32.76	-32.77	47.15	74.00	26.85
*4 880.20	40.44	Average	H	32.76	-32.77	40.43	54.00	13.57
*7 320.74	46.99	Peak	H	35.88	-29.44	53.43	74.00	20.57
*7 320.50	40.43	Average	H	35.88	-29.44	46.87	54.00	7.13
Above 7 400.00	Not detected	-	-	-		-	-	-

The results shown in this test report refer only to the sample(s) tested unless otherwise stated. This test report cannot be reproduced, except in full, without prior written permission of the Company. This test report does not assure KOLAS accreditation.

## C. High Channel (2 480 MHz)

Radiated Emissions			Ant.	Correction Factors		Total	Limit	
Frequency (MHz)	Reading (dB $\mu$ V)	Detect Mode	Pol.	AF (dB/m)	CL (dB)	Actual (dB $\mu$ V/m)	Limit (dB $\mu$ V/m)	Margin (dB)
*2 483.50	15.71	Peak	H	28.00	7.84	51.55	74.00	22.45
*2 483.50	6.26	Average	H	28.00	7.84	42.10	54.00	11.90
*2 489.46	17.39	Peak	H	28.00	7.85	53.24	74.00	20.76
*2 494.81	6.79	Average	H	28.00	7.86	42.65	54.00	11.35
*2 500.00	15.89	Peak	H	28.00	7.87	51.76	74.00	22.24
*2 500.00	5.51	Average	H	28.00	7.87	41.38	54.00	12.62

Radiated Emissions			Ant.	Correction Factors		Total	Limit	
Frequency (MHz)	Reading (dB $\mu$ V)	Detect Mode	Pol.	AF (dB/m)	AMP+CL (dB)	Actual (dB $\mu$ V/m)	Limit (dB $\mu$ V/m)	Margin (dB)
*4 959.40	46.15	Peak	H	32.82	-32.64	46.33	74.00	27.67
*4 960.10	39.47	Average	H	32.82	-32.63	39.66	54.00	14.34
*7 439.36	43.56	Peak	H	35.86	-28.67	50.75	74.00	23.25
*7 439.38	36.61	Average	H	35.86	-28.67	43.80	54.00	10.20
Above 7 500.00	Not detected	-	-	-		-	-	-

**Remarks;**

1. “\*” means the restricted band.
2. Measuring frequencies from 1 GHz to the 10<sup>th</sup> harmonic of highest fundamental frequency.
3. Actual = Reading + AF + CL or AF + AMP + CL.
4. According to § 15.31(o), emission levels are not reported much lower than the limits by over 20 dB.

The results shown in this test report refer only to the sample(s) tested unless otherwise stated. This test report cannot be reproduced, except in full, without prior written permission of the Company. This test report does not assure KOLAS accreditation.

**- Test plots**

Low channel Band edge (Peak)

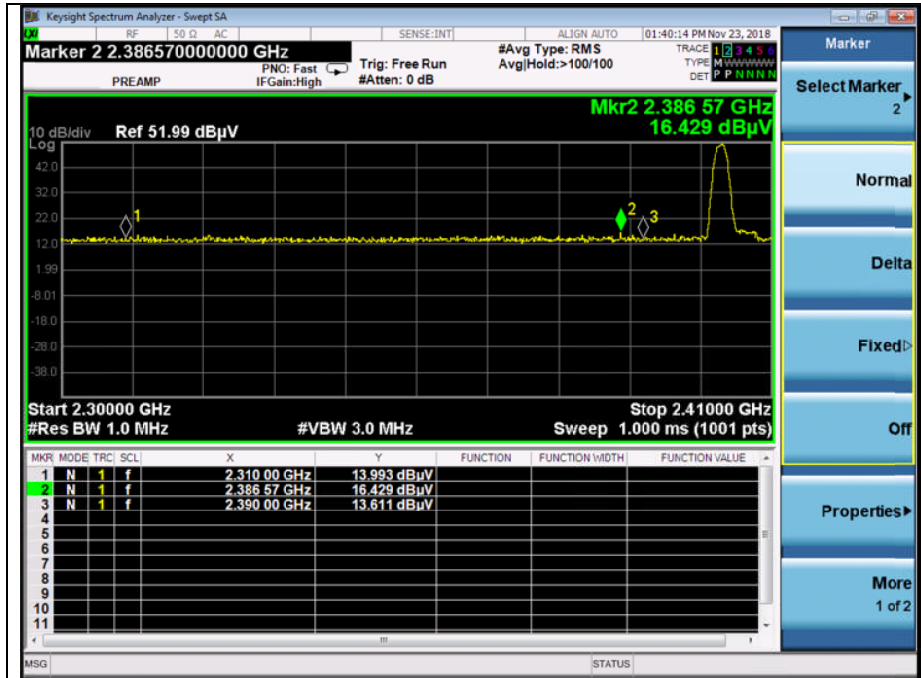

Low channel Band edge (Average)

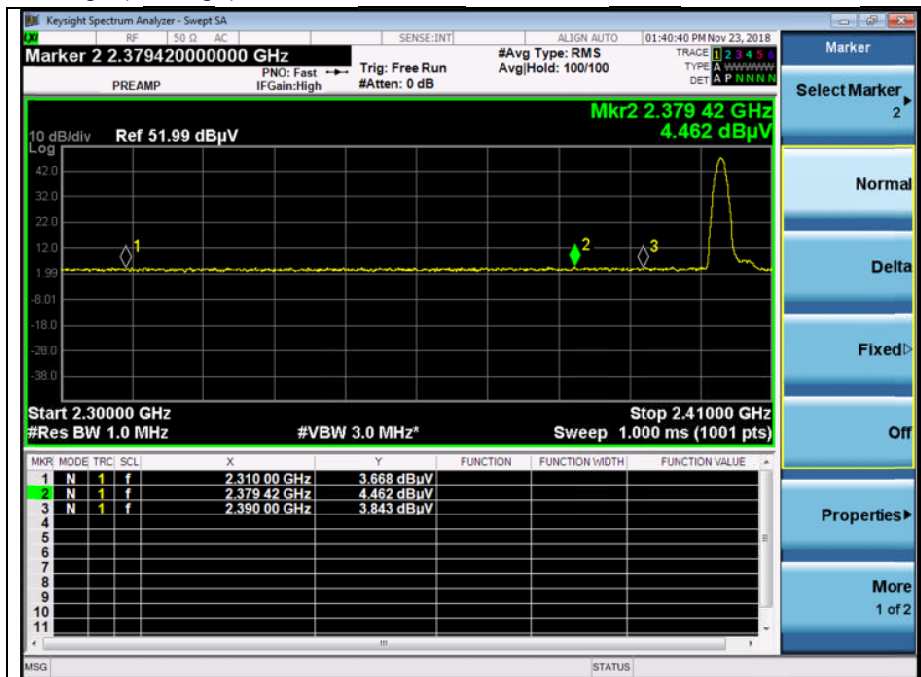

The results shown in this test report refer only to the sample(s) tested unless otherwise stated. This test report cannot be reproduced, except in full, without prior written permission of the Company. This test report does not assure KOLAS accreditation.

High channel Band edge (Peak)

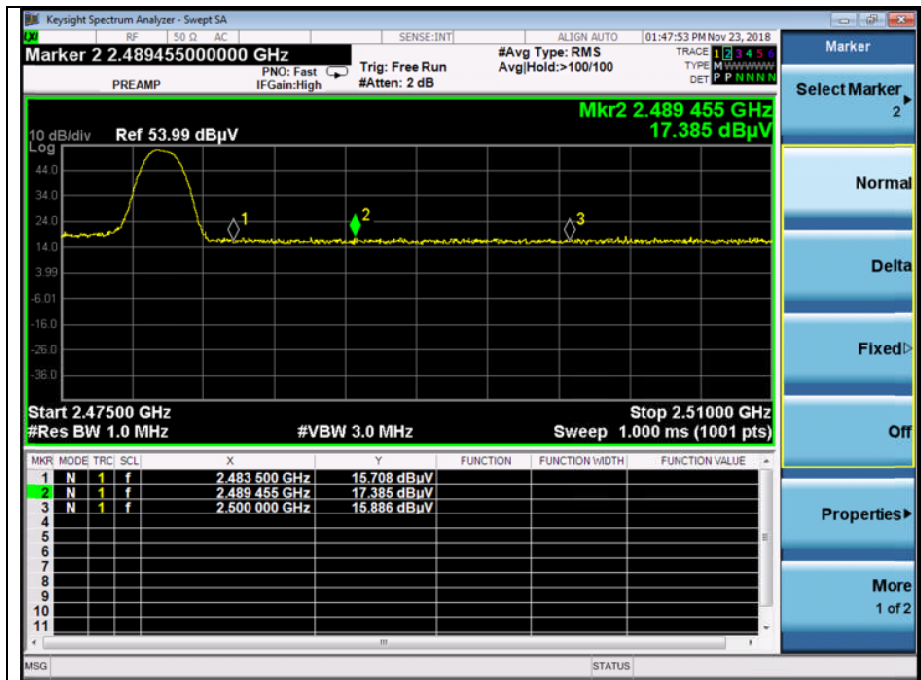

High channel Band edge (Average)

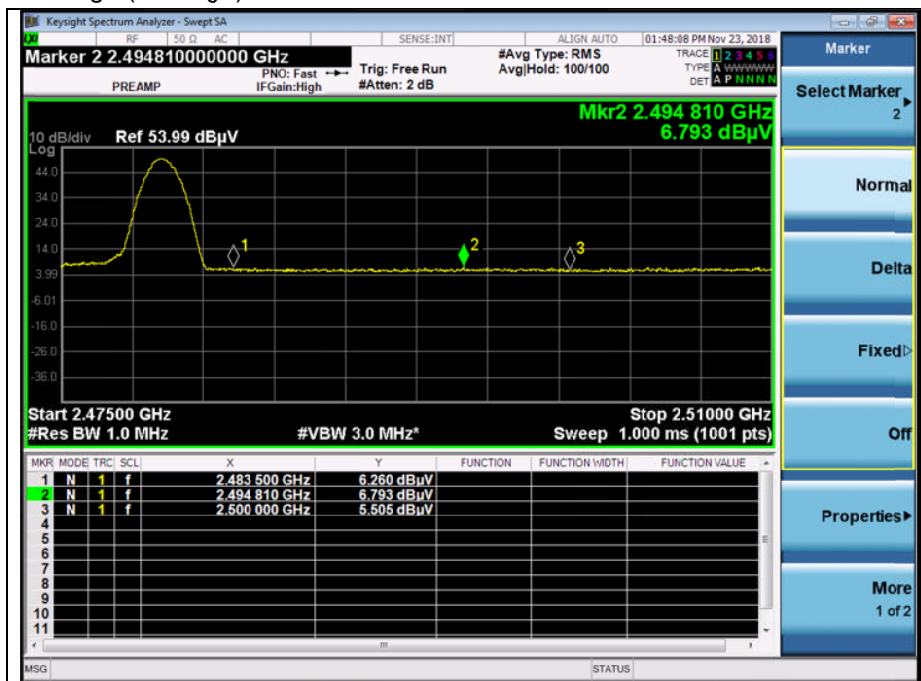

The results shown in this test report refer only to the sample(s) tested unless otherwise stated. This test report cannot be reproduced, except in full, without prior written permission of the Company. This test report does not assure KOLAS accreditation.

Low channel 2<sup>nd</sup> harmonic (Peak)

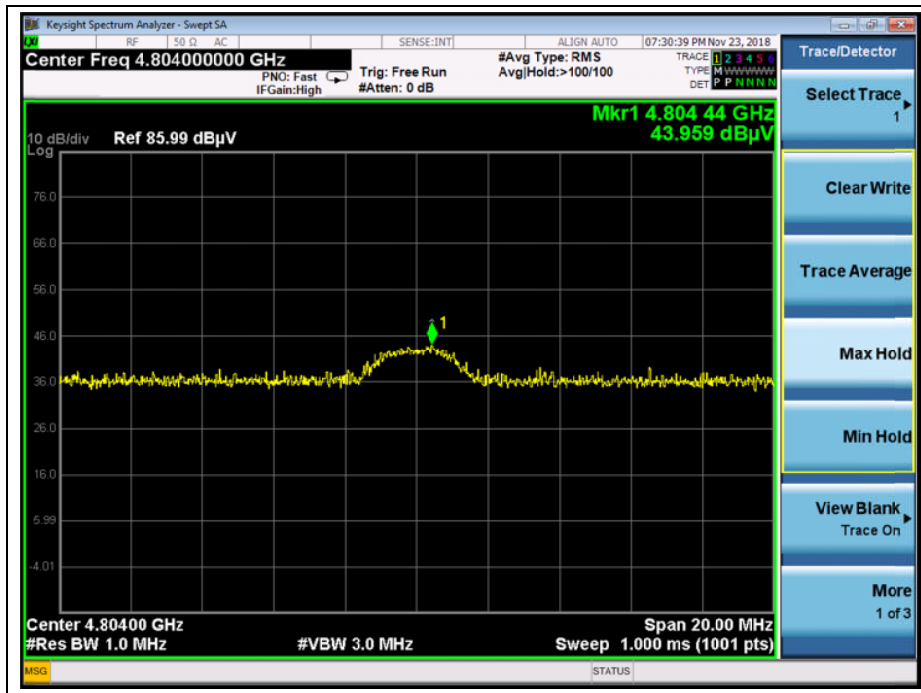

Low channel 2<sup>nd</sup> harmonic (Average)

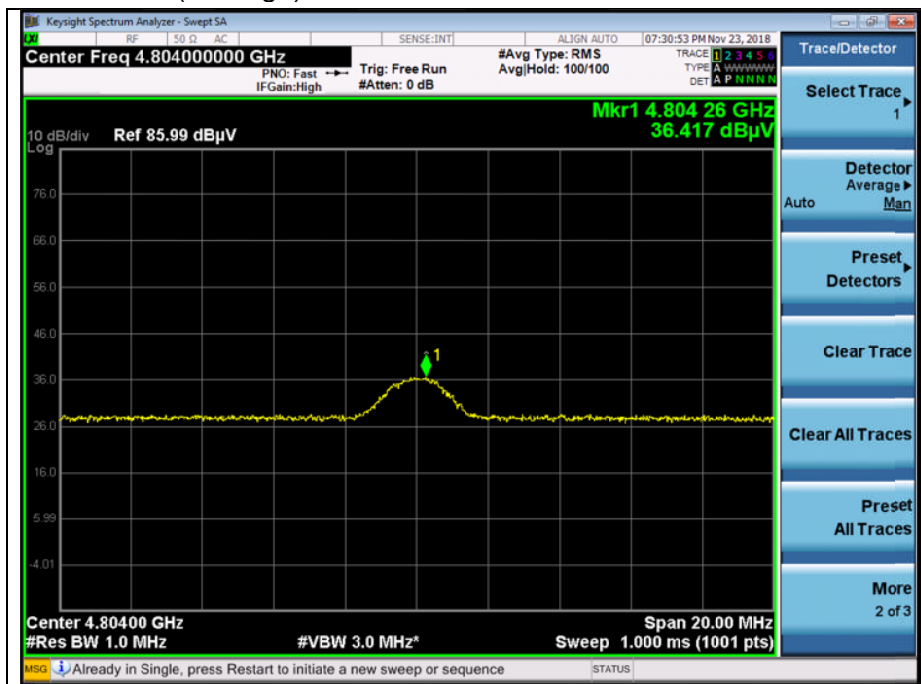

The results shown in this test report refer only to the sample(s) tested unless otherwise stated. This test report cannot be reproduced, except in full, without prior written permission of the Company. This test report does not assure KOLAS accreditation.

Middle channel 2<sup>nd</sup> harmonic (Peak)

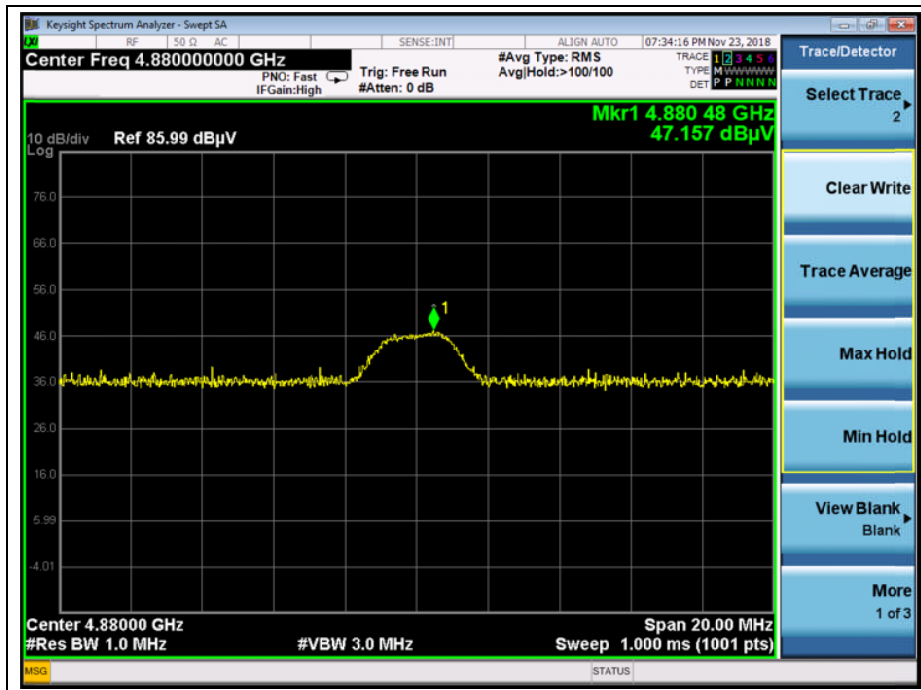

Middle channel 2<sup>nd</sup> harmonic (Average)

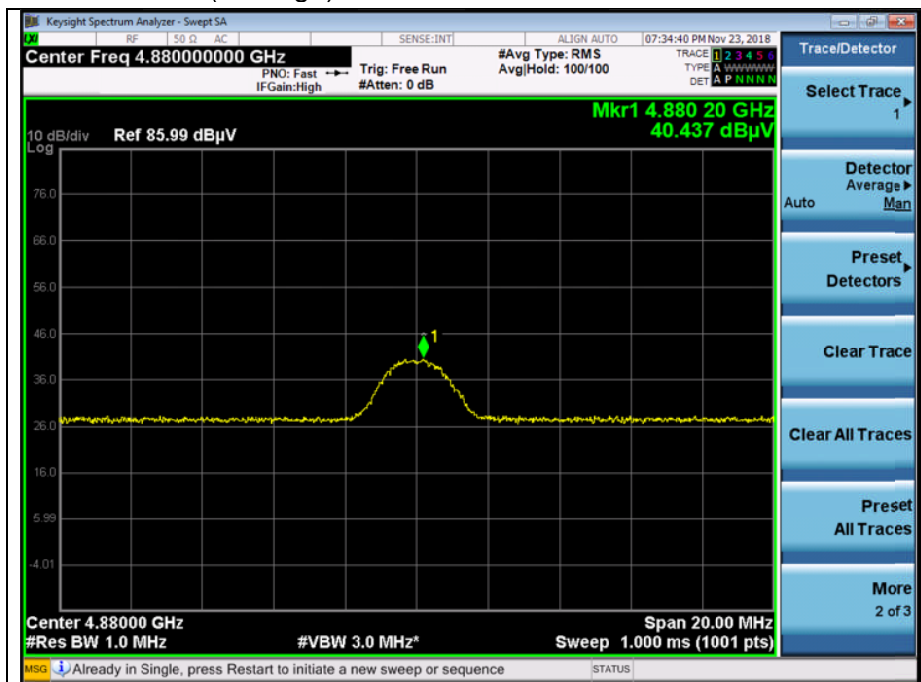

The results shown in this test report refer only to the sample(s) tested unless otherwise stated. This test report cannot be reproduced, except in full, without prior written permission of the Company. This test report does not assure KOLAS accreditation.

High channel 2<sup>nd</sup> harmonic (Peak)

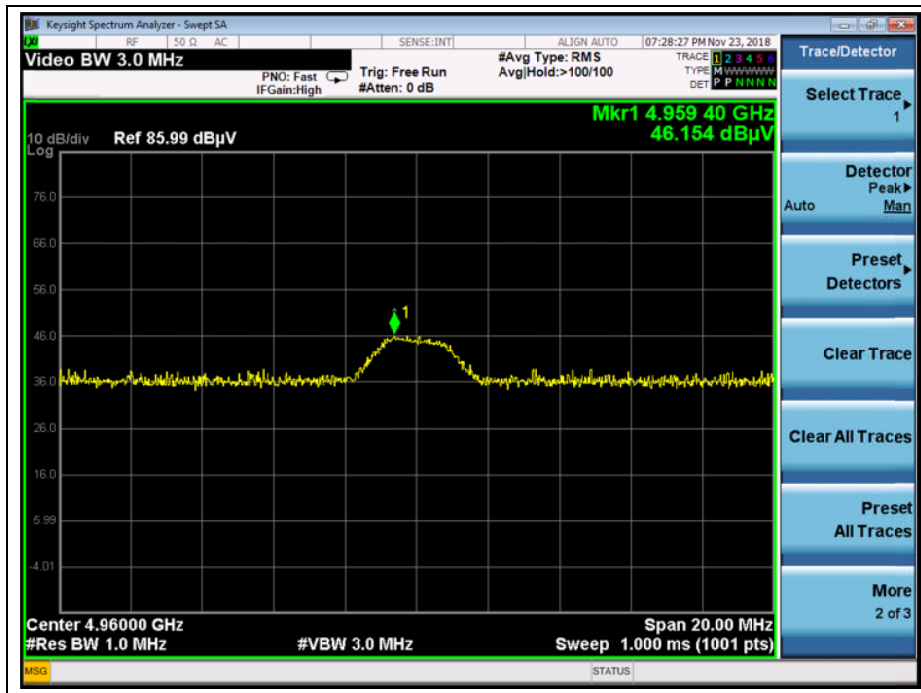

High channel 2<sup>nd</sup> harmonic (Average)

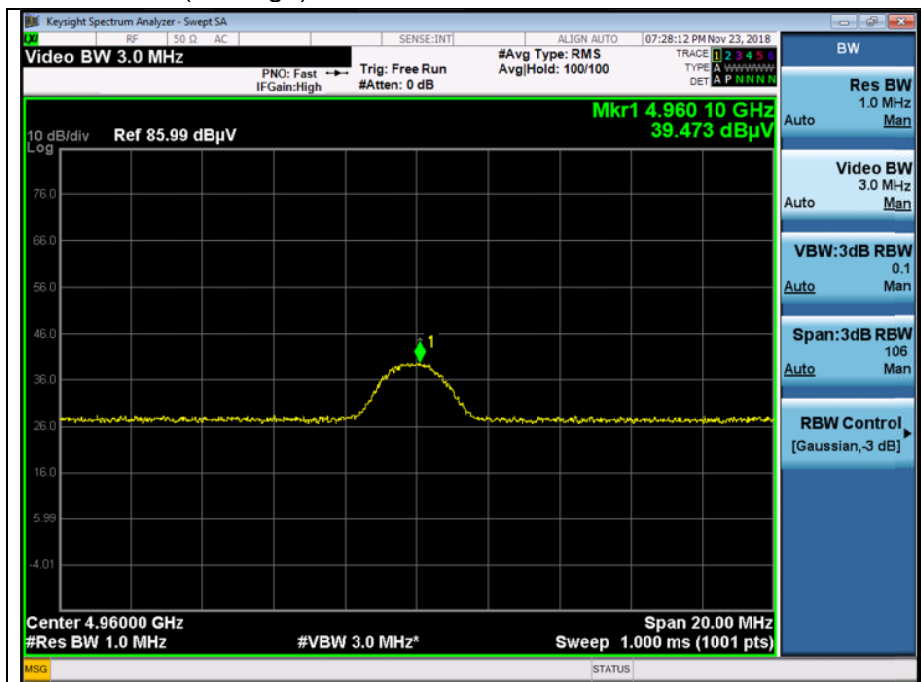

The results shown in this test report refer only to the sample(s) tested unless otherwise stated. This test report cannot be reproduced, except in full, without prior written permission of the Company. This test report does not assure KOLAS accreditation.

Low channel 3<sup>rd</sup> harmonic (Peak)

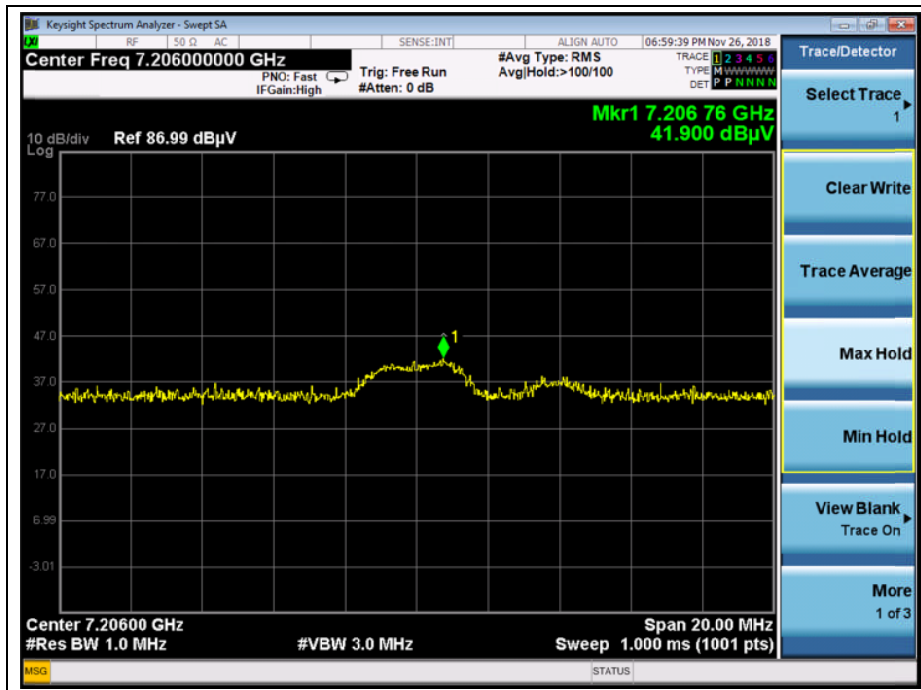

Low channel 3<sup>rd</sup> harmonic (Average)

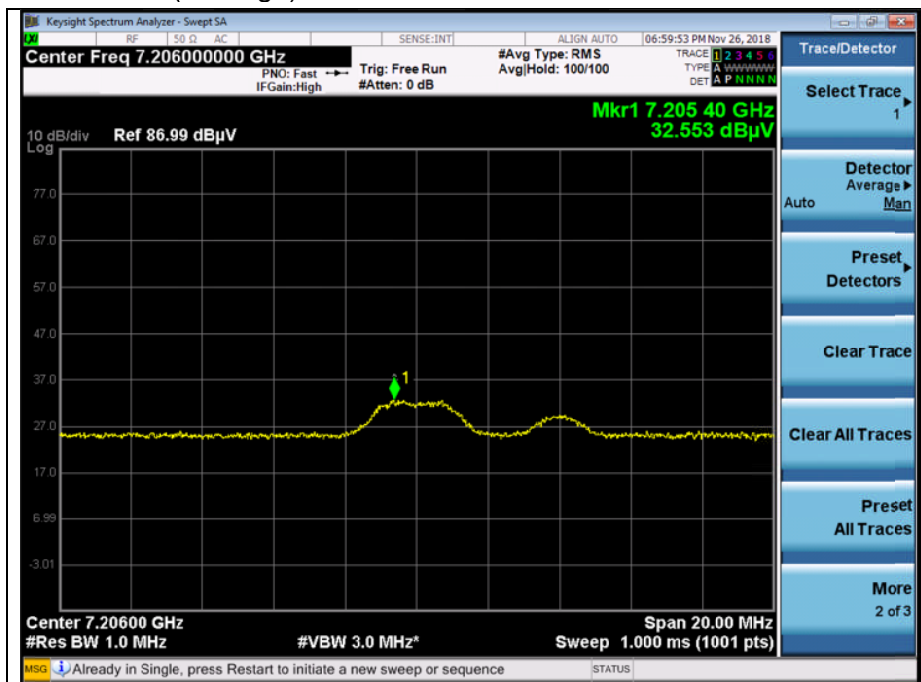

The results shown in this test report refer only to the sample(s) tested unless otherwise stated. This test report cannot be reproduced, except in full, without prior written permission of the Company. This test report does not assure KOLAS accreditation.

SGS Korea Co., Ltd. (Gunpo Laboratory) 4, LS-ro 182beon-gil, Gunpo-si, Gyeonggi-do, Korea, 15807 <http://www.sgsgroup.kr>



Middle channel 3<sup>rd</sup> harmonic (Peak)

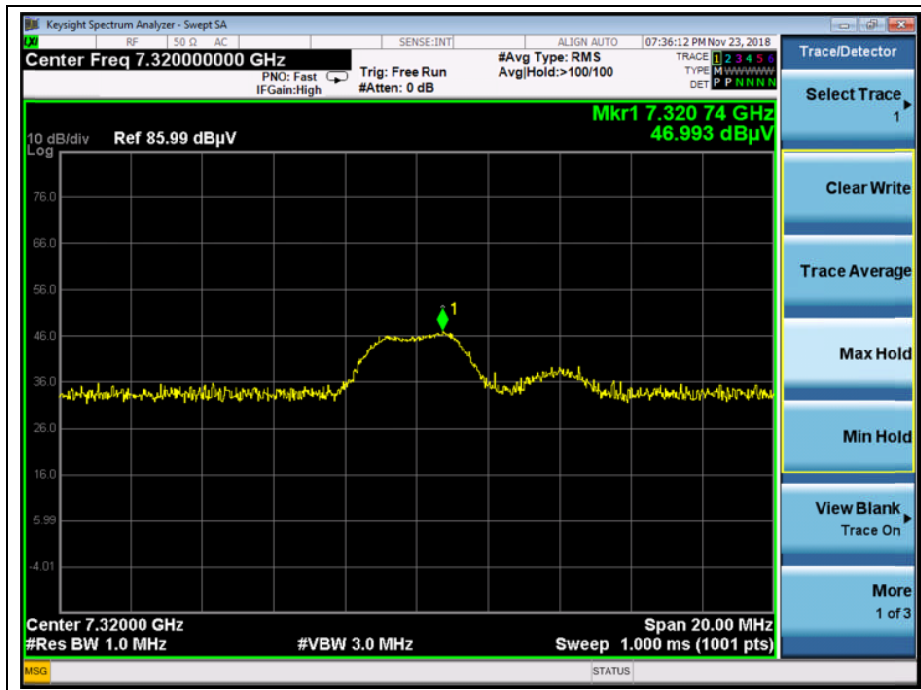

Middle channel 3<sup>rd</sup> harmonic (Average)

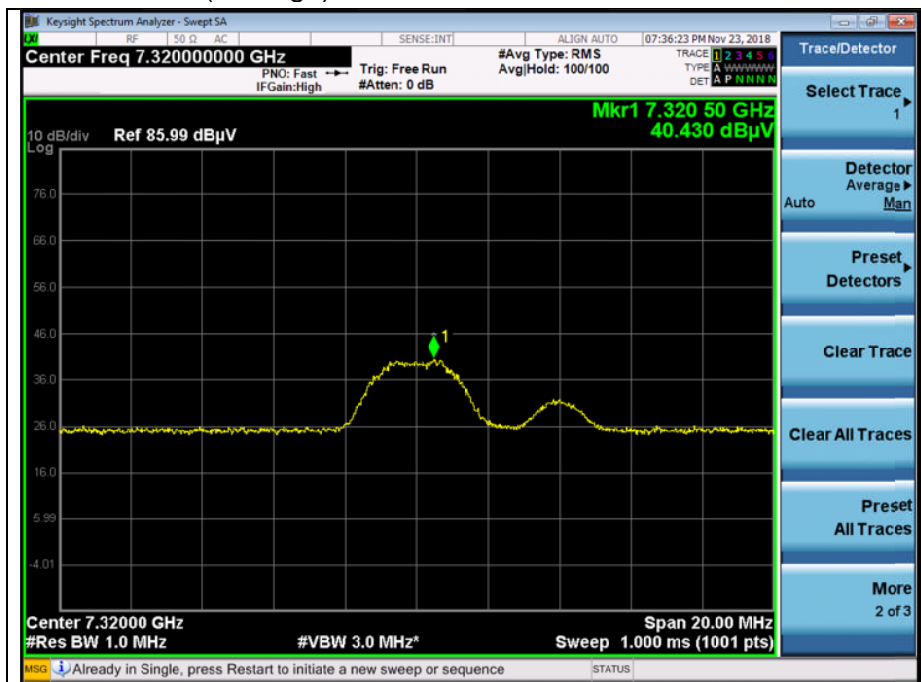

The results shown in this test report refer only to the sample(s) tested unless otherwise stated. This test report cannot be reproduced, except in full, without prior written permission of the Company. This test report does not assure KOLAS accreditation.

SGS Korea Co., Ltd. (Gunpo Laboratory) 4, LS-ro 182beon-gil, Gunpo-si, Gyeonggi-do, Korea, 15807 <http://www.sgsgroup.kr>

High channel 3<sup>rd</sup> harmonic (Peak)

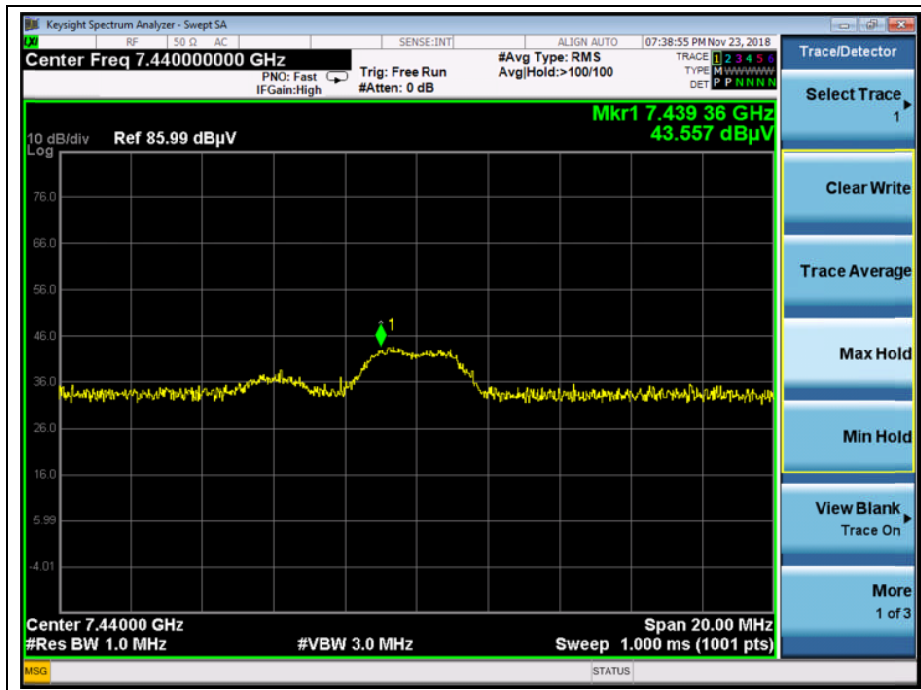

High channel 3<sup>rd</sup> harmonic (Average)

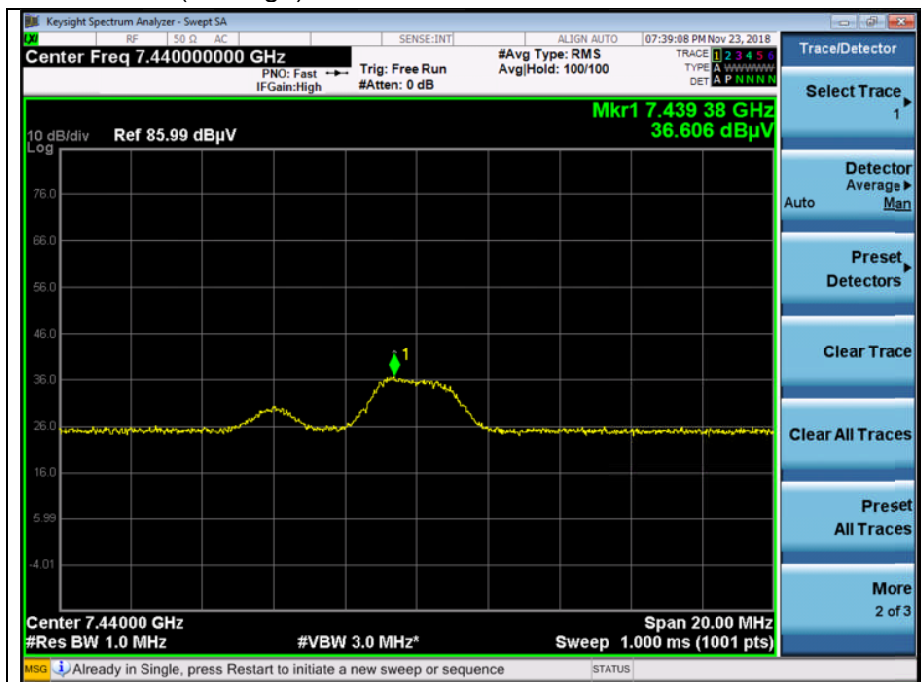

The results shown in this test report refer only to the sample(s) tested unless otherwise stated. This test report cannot be reproduced, except in full, without prior written permission of the Company. This test report does not assure KOLAS accreditation.

### 3. 20 dB Bandwidth

#### 3.1. Test Setup

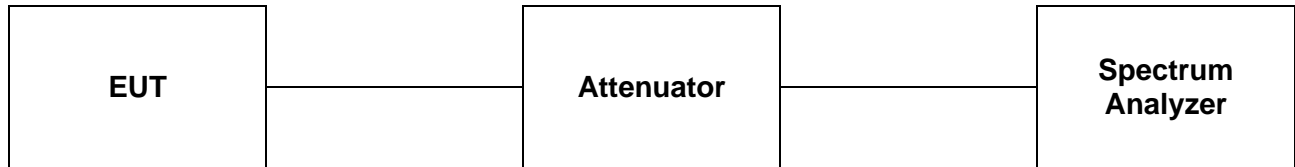

#### 3.2. Limit

Limit: Not Applicable

#### 3.3. Test Procedure

The test follows ANSI C63.10-2013.

The 20 dB bandwidth was measured with a spectrum analyzer connected to RF antenna connector (conducted measurement) while EUT was operating in transmit mode at the appropriate center frequency.

Use the following spectrum analyzer setting:

Span = approximately 2 to 5 times the 20 dB bandwidth.

RBW  $\geq$  1 % to 5 % of the 20 dB bandwidth.

VBW  $\geq$  3 x RBW

Sweep = auto

Detector = peak

Trace = max hold

The marker-to-peak function to set the mark to the peak of the emission. Use the marker-delta function to measure 20 dB down one side of the emission. Reset the function, and move the marker to the other side of the emission, until it is (as close as possible to) even with the reference marker level. The marker-delta reading at this point is 20 dB bandwidth of the emission.

*The results shown in this test report refer only to the sample(s) tested unless otherwise stated. This test report cannot be reproduced, except in full, without prior written permission of the Company. This test report does not assure KOLAS accreditation.*

**SGS Korea Co., Ltd. (Gunpo Laboratory)** 4, LS-ro 182beon-gil, Gunpo-si, Gyeonggi-do, Korea, 15807 <http://www.sgsgroup.kr>

RTT5041-19(2017.07.10)(0)

Tel. +82 31 428 5700 / Fax. +82 31 427 2370

A4(210 mm x 297 mm)

### 3.4. Test Results

Ambient temperature : (23 ± 1) °C  
 Relative humidity : 47 % R.H.

Channel	Frequency (MHz)	20 dB Bandwidth (MHz)
Low	2 402	1.085
Middle	2 440	1.085
High	2 480	1.100

*The results shown in this test report refer only to the sample(s) tested unless otherwise stated. This test report cannot be reproduced, except in full, without prior written permission of the Company. This test report does not assure KOLAS accreditation.*

**- Test plots**

Low Channel

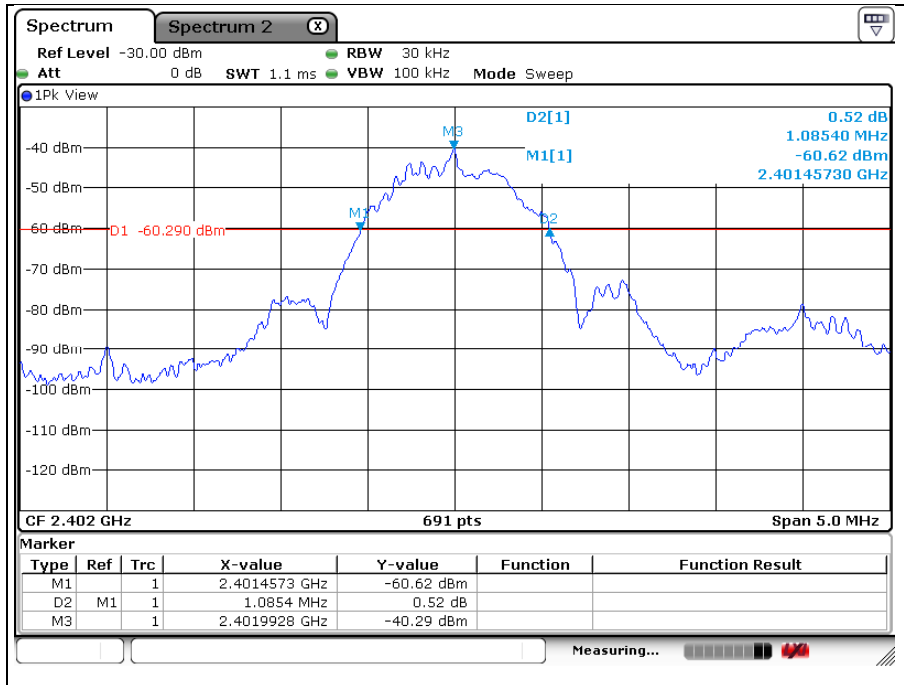

Middle Channel

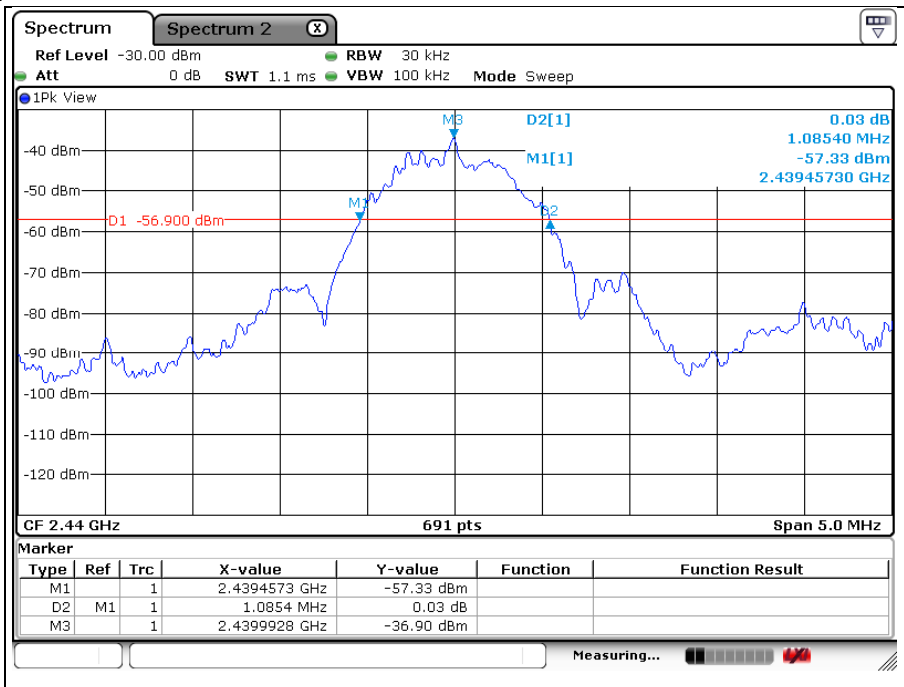

The results shown in this test report refer only to the sample(s) tested unless otherwise stated. This test report cannot be reproduced, except in full, without prior written permission of the Company. This test report does not assure KOLAS accreditation.

High Channel

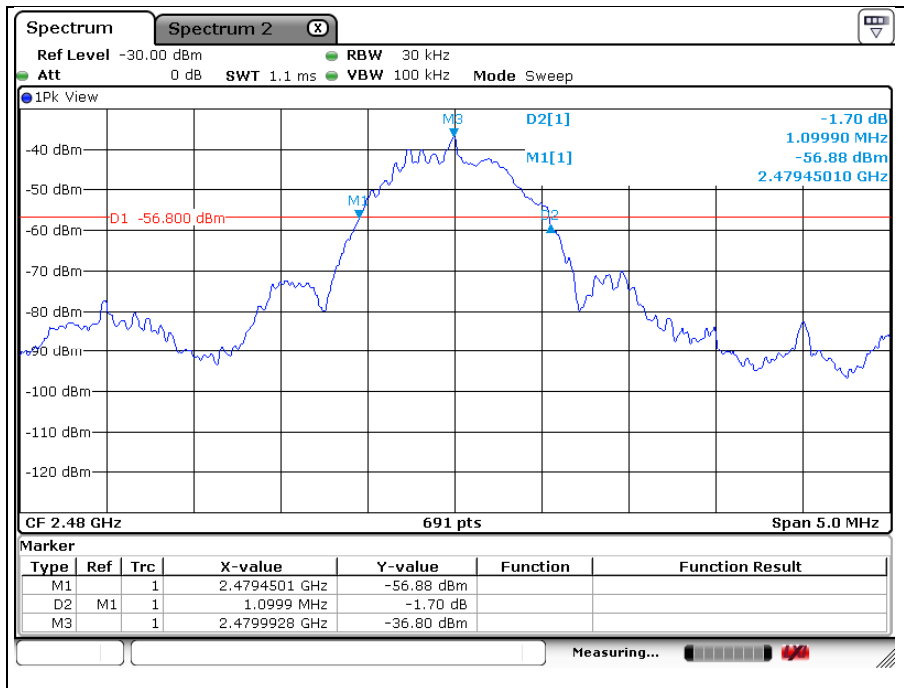

The results shown in this test report refer only to the sample(s) tested unless otherwise stated. This test report cannot be reproduced, except in full, without prior written permission of the Company. This test report does not assure KOLAS accreditation.

## 4. Transmitter AC Power Line Conducted Emission

### 4.1. Test Setup

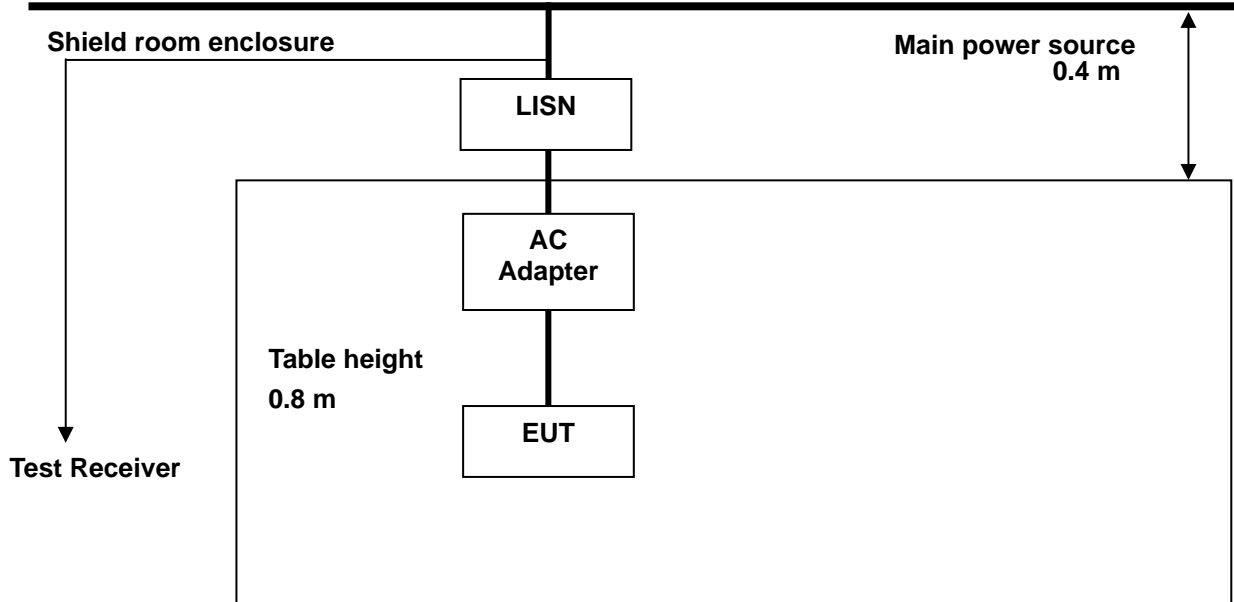

### 4.2. Limit

According to §15.207(a), for an intentional radiator that is designed to be connected to the public utility (AC) power line, the radio frequency voltage that is conducted back onto the AC power line on any frequency or frequencies, within the band 150 kHz to 30 MHz, shall not exceed the limits in the following table, as measured using a 50  $\mu$  H /50 ohms line impedance stabilization network (LISN). Compliance with the provision of this paragraph shall be based on the measurement of the radio frequency voltage between each power line and ground at the power terminal. The lower limit applies at the boundary between the frequency ranges.

Frequency of emission (MHz)	Conducted limit (dB $\mu$ V)	
	Quasi-peak	Average
0.15-0.5	66 to 56*	56 to 46*
0.5-5	56	46
5-30	60	50

\* Decreases with the logarithm of the frequency.

The results shown in this test report refer only to the sample(s) tested unless otherwise stated. This test report cannot be reproduced, except in full, without prior written permission of the Company. This test report does not assure KOLAS accreditation.

SGS Korea Co., Ltd. (Gunpo Laboratory) 4, LS-ro 182beon-gil, Gunpo-si, Gyeonggi-do, Korea, 15807 <http://www.sgsgroup.kr>

---

### 4.3. Test Procedures

AC conducted emissions from the EUT were measured according to the dictates of ANSI C63.10:2013

1. The test procedure is performed in a 6.5 m × 3.5 m × 3.5 m (L × W × H) shielded room. The EUT along with its peripherals were placed on a 1.0 m (W) × 1.5 m (L) and 0.8 m in height wooden table and the EUT was adjusted to maintain a 0.4 meter space from a vertical reference plane.
2. The EUT was connected to power mains through a line impedance stabilization network (LISN) which provides 50 ohm coupling impedance for measuring instrument and the chassis ground was bounded to the horizontal ground plane of shielded room.
3. All peripherals were connected to the second LISN and the chassis ground also bounded to the horizontal ground plane of shielded room.
4. The excess power cable between the EUT and the LISN was bundled. The power cables of peripherals were unbundled. All connecting cables of EUT and peripherals were moved to find the maximum emission.

---

*The results shown in this test report refer only to the sample(s) tested unless otherwise stated. This test report cannot be reproduced, except in full, without prior written permission of the Company. This test report does not assure KOLAS accreditation.*



#### 4.4. Test Results

The following table shows the highest levels of conducted emissions on both phase of Hot and Neutral line.

Ambient temperature : (23 ± 1) °C  
 Relative humidity : 47 % R.H.  
 Frequency range : 0.15 MHz - 30 MHz  
 Measured Bandwidth : 9 kHz

FREQ. (MHz)	LEVEL (dB $\mu$ V)		LINE	LIMIT (dB $\mu$ V)		MARGIN (dB)	
	Q-Peak	Average		Q-Peak	Average	Q-Peak	Average
0.20	33.90	16.20	N	63.61	53.61	29.71	37.41
0.67	32.60	26.00	N	56.00	46.00	23.40	20.00
2.04	18.90	14.40	N	56.00	46.00	37.10	31.60
3.79	18.50	13.90	N	56.00	46.00	37.50	32.10
10.07	19.70	12.60	N	60.00	50.00	40.30	37.40
15.59	21.40	15.90	N	60.00	50.00	38.60	34.10
0.17	37.00	21.10	H	64.96	54.96	27.96	33.86
0.67	36.50	27.70	H	56.00	46.00	19.50	18.30
3.19	21.60	15.70	H	56.00	46.00	34.40	30.30
5.95	21.60	14.50	H	60.00	50.00	38.40	35.50
11.09	24.70	18.10	H	60.00	50.00	35.30	31.90
16.00	24.90	16.30	H	60.00	50.00	35.10	33.70

#### Remark;

1. Line ( H ): Hot, Line ( N ): Neutral.
2. The limit for Class B device(s) from 150 kHz to 30 MHz are specified in Section of the Title 47 CFR.
3. Traces shown in plot were made by using a peak detector and average detector.
4. Deviations to the Specifications: None.

*The results shown in this test report refer only to the sample(s) tested unless otherwise stated. This test report cannot be reproduced, except in full, without prior written permission of the Company. This test report does not assure KOLAS accreditation.*

Test mode: (Neutral)

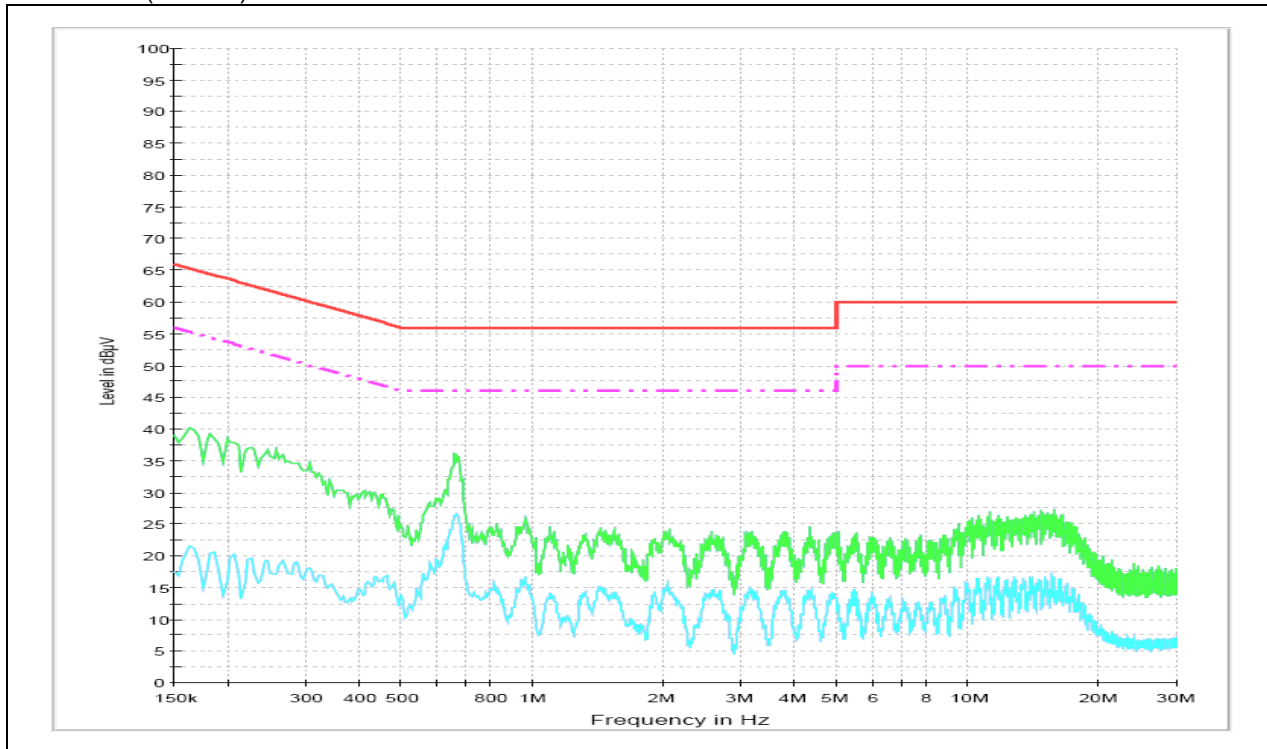

Test mode: (Hot)

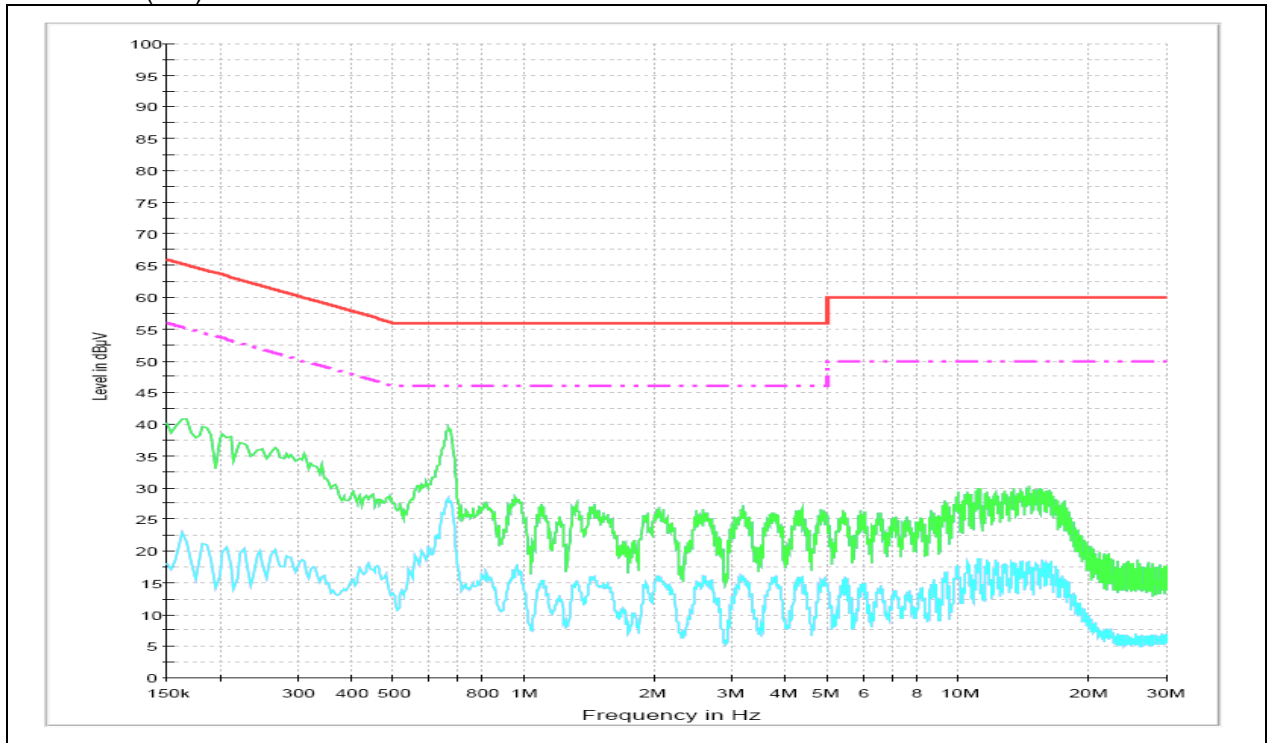

The results shown in this test report refer only to the sample(s) tested unless otherwise stated. This test report cannot be reproduced, except in full, without prior written permission of the Company. This test report does not assure KOLAS accreditation.

---

## 5. Antenna Requirement

### 5.1. Standard Applicable

For intentional device, according to FCC 47 CFR Section §15.203, an intentional radiator shall be designed to ensure that no antenna other than that furnished by the responsible party shall be used with the device. And according to FCC 47 CFR Section §15.247 (b) if transmitting antennas of directional gain greater than 6 dBi are used, the power shall be reduced by the amount in dB that the gain of the antenna exceeds 6 dBi.

### 5.2. Antenna Connected Construction

Antenna used in this product is Chip Antenna with gain of 0 dBi.

**- End of the Test Report -**

---

*The results shown in this test report refer only to the sample(s) tested unless otherwise stated. This test report cannot be reproduced, except in full, without prior written permission of the Company. This test report does not assure KOLAS accreditation.*

**SGS Korea Co., Ltd. (Gunpo Laboratory)** 4, LS-ro 182beon-gil, Gunpo-si, Gyeonggi-do, Korea, 15807 <http://www.sgsgroup.kr>