

FCC Part 15C

Measurement and Test Report

For

Shenzhen MODO Innovation Technology Co.Ltd

FCC ID:2ARYF-AW-90

FCC Rule(s):	<u>FCC Part 15.247</u>	
Product Description:	<u>WIRELESS EARBUDS WITH WIRELESS SPEAKER</u>	
Tested Model:	<u>AW-90</u>	
Report No.:	<u>BSL181185504002RF</u>	
Tested Date:	<u>December 10-20, 2018</u>	
Issued Date:	<u>December 20, 2018</u>	
Tested By:	<u>Steven Wen / Engineer</u>	<i>steven</i>
Reviewed By:	<u>Lisa. Li / EMC Manager</u>	<i>Lisa. Li</i>
Approved & Authorized By:	<u>Mike mo / PSQ Manager</u>	<i>Mike mo</i>
Prepared By:		

BSL Testing Co.,LTD.
NO. 24, ZH Park, Nantou, Shenzhen, 518000 China
Tel: 400-882-9628 Fax: 86- 755-26508703

TABLE OF CONTENTS

1. GENERAL INFORMATION.....	3
1.1 PRODUCT DESCRIPTION FOR EQUIPMENT UNDER TEST (EUT).....	3
1.2 EUT SETUP AND TEST MODE.....	5
1.3 TEST STANDARDS.....	5
1.4 TEST METHODOLOGY.....	5
1.5 TEST FACILITY.....	5
1.6 MEASUREMENT UNCERTAINTY.....	6
1.7 TEST EQUIPMENT LIST AND DETAILS.....	6
2. SUMMARY OF TEST RESULTS.....	7
3. RF EXPOSURE.....	8
3.1 STANDARD APPLICABLE.....	8
3.2 TEST RESULT.....	8
4. ANTENNA REQUIREMENT.....	9
4.1 STANDARD APPLICABLE.....	9
4.2 EVALUATION INFORMATION.....	9
5. CONDUCTED EMISSIONS.....	10
6. CONDUCTED PEAK OUTPUT POWER.....	11
7. 20DB EMISSION BANDWIDTH.....	12
8. CARRIER FREQUENCIES SEPARATION.....	19
9. HOPPING CHANNEL NUMBER.....	22
10. DWELL TIME.....	25
11. PSEUDORANDOM FREQUENCY HOPPING SEQUENCE.....	28
12. BAND EDGE.....	29
14. SPURIOUS EMISSION.....	35
15. TEST SETUP PHOTO.....	46
16. EUT CONSTRUCTIONAL DETAILS.....	47

1. GENERAL INFORMATION

1.1 Product Description for Equipment Under Test (EUT)

Applicant:	Shenzhen MODO Innovation Technology Co.Ltd
Address of applicant:	Room B303, FuAn Science Building. 1st Road of GaoXin South, Nanshan District,Shenzhen City, Guangdong Province,China
Manufacturer:	Shenzhen MODO Innovation Technology Co.Ltd
Address of manufacturer:	Room B303, FuAn Science Building. 1st Road of GaoXin South, Nanshan District,Shenzhen City, Guangdong Province,China
Product Name:	WIRELESS EARBUDS WITH WIRELESS SPEAKER
Model No.:	AW-90
Test Model No:	AW-90
Remark: All above models are identical in the same PCB layout, interior structure and electrical circuits. The differences are color, appearance and model name for commercial purpose.	
Quantity of tested samples	1
Serial No.:	AW-90
Description test modes:	N/A
Hardware Version:	MB3 T1.2
Software Version:	N/A
Operation Frequency:	2402MHz~2480MHz
Channel numbers:	79
Channel separation:	1MHz
Modulation type:	GFSK,Pi/4 QPSK,8DPSK
Antenna Type:	Ceramic antenna
Antenna gain:	0dBi
Power supply:	DC 3.7V by battery

Operation Frequency each of channel							
Channel	Frequency	Channel	Frequency	Channel	Frequency	Channel	Frequency
1	2402MHz	21	2422MHz	41	2442MHz	61	2462MHz
2	2403MHz	22	2423MHz	42	2443MHz	62	2463MHz
3	2404MHz	23	2424MHz	43	2444MHz	63	2464MHz
4	2405MHz	24	2425MHz	44	2445MHz	64	2465MHz
5	2406MHz	25	2426MHz	45	2446MHz	65	2466MHz
6	2407MHz	26	2427MHz	46	2447MHz	66	2467MHz
7	2408MHz	27	2428MHz	47	2448MHz	67	2468MHz
8	2409MHz	28	2429MHz	48	2449MHz	68	2469MHz
9	2410MHz	29	2430MHz	49	2450MHz	69	2470MHz
10	2411MHz	30	2431MHz	50	2451MHz	70	2471MHz
11	2412MHz	31	2432MHz	51	2452MHz	71	2472MHz
12	2413MHz	32	2433MHz	52	2453MHz	72	2473MHz
13	2414MHz	33	2434MHz	53	2454MHz	73	2474MHz
14	2415MHz	34	2435MHz	54	2455MHz	74	2475MHz
15	2416MHz	35	2436MHz	55	2456MHz	75	2476MHz
16	2417MHz	36	2437MHz	56	2457MHz	76	2477MHz
17	2418MHz	37	2438MHz	57	2458MHz	77	2478MHz
18	2419MHz	38	2439MHz	58	2459MHz	78	2479MHz
19	2420MHz	39	2440MHz	59	2460MHz	79	2480MHz
20	2421MHz	40	2441MHz	60	2461MHz		

Note:

In section 15.31(m), regards to the operating frequency range over 10 MHz, the Lowest frequency, the middle frequency, and the highest frequency of channel were selected to perform the test.

EUT Cable List and Details

Cable Description	Length (M)	Shielded/Unshielded	With Core/Without Core
/	/	/	/

Auxiliary Equipment List and Details

Description	Manufacturer	Model	Serial Number
Notebook	Lenovo	Lenovo B490	BSTSZEMC-77

Special Cable List and Details

Cable Description	Length (M)	Shielded/Unshielded	With Core/Without Core
/	/	/	/

1.2 EUT Setup and Test Mode

The EUT was operated in the engineering mode to fix the Tx frequency that was for the purpose of the measurements. All testing shall be performed under maximum output power condition, and to measure its highest possible emissions level, more detailed description as follows: During the test, pre-scan F18m, F18, AW-90, and found the F18m model which it is worse case model.

Test Mode List			
Test Mode	Description	Channel	Frequency (MHz)
1	GFSK,	CH1	2402
		CH40	2441
		CH79	2480
2	Pi/4 QPSK	CH1	2402
		CH40	2441
		CH79	2480
3	8DPSK	CH1	2402
		CH40	2441
		CH79	2480

1.3 Test Standards

The following report accordance with FCC Part 15, Subpart C, and section 15.203, 15.205, 15.207, 15.209 and 15.247 of the Federal Communication Commissions rules.

1.4 Test Methodology

All measurements contained in this report were conducted with ANSI C63.10-2013, American National Standard for Testing Unlicensed Wireless Devices, and ANSI C63.4-2014, American National Standard for Methods of Measurement of Radio-Noise Emissions from Low-Voltage Electrical and Electronic Equipment in the range of 9 kHz to 40 GHz.

1.5 Test Facility

BSL Testing Co.,LTD.

NO. 24, ZH Park, Nantou, Shenzhen, 518000 China

Test Firm Registration Number: 866035

Designation Number: CN1217

Tel: 400-882-9628

Fax: 86-755-26508703

1.6 Measurement Uncertainty

Measurement uncertainty		
Parameter	Conditions	Uncertainty
RF Output Power	Conducted	$\pm 0.42\text{dB}$
Occupied Bandwidth	Conducted	$\pm 1.5\%$
Power Spectral Density	Conducted	$\pm 1.8\text{dB}$
Conducted Spurious Emission	Conducted	$\pm 2.17\text{dB}$
Conducted Emissions	Conducted	$\pm 2.88\text{dB}$
Transmitter Spurious Emissions	Radiated	$\pm 5.1\text{dB}$

1.7 Test Equipment List and Details

Description	Manufacturer	Model	Serial No.	Cal Date	Due. Date
Communication Tester	Rohde & Schwarz	CMW500	100358	2017-10-21	2018-10-20
Spectrum Analyzer	R&S	FSP40	100550	2017-10-21	2018-10-20
Test Receiver	R&S	ESCI7	US47140102	2017-10-21	2018-10-20
Signal Generator	HP	83630B	3844A01028	2017-10-22	2018-10-21
Test Receiver	R&S	ESPI-3	100180	2017-10-21	2018-10-20
Amplifier	Agilent	8449B	4035A00116	2017-10-22	2018-10-21
Amplifier	HP	8447E	2945A02770	2017-10-22	2018-10-21
Signal Generator	IFR	2023A	202307/242	2017-10-22	2018-10-21
Broadband Antenna	SCHAFFNER	2774	2774	2017-10-17	2018-10-16
Biconical and log periodic antennas	ELECTRO-METRIC	EM-6917B-1	171	2017-10-17	2018-10-16
Horn Antenna	R&S	HF906	100253	2017-10-17	2018-10-16
Horn Antenna	EM	EM-6961	6462	2017-10-17	2018-10-16
LISN	R&S	ESH3-Z5	100196	2017-10-17	2018-10-16
LISN	COM-POWER	LI-115	02027	2017-10-17	2018-10-16
3m Semi-Anechoic Chamber	Chengyu Electron	9 (L)*6 (W)* 6 (H)	BSL086	2017-10-21	2018-10-20
Horn Antenna	A-INFOMW	LB-180400KF	BSL088	2017-10-21	2018-10-20
20dB Attenuator	ICPROBING	IATS1	BSL1003	2017-10-21	2018-10-20
POWER DIVIDER	Mini-circuits	PD-2SF-0010	N/A	2017-10-21	2018-10-20
POWER DIVIDER	Mini-circuits	PD-2SF-0010	N/A	2017-10-21	2018-10-20
Loop Antenna	Schwarz beck	FMZB 1516	9773	2018-06-16	2019-06-15

2. SUMMARY OF TEST RESULTS

Test Item	Section in CFR 47	Result
RF Exposure (SAR)	Part 1.1307 Part 2.1093	Pass* (Please refer to SAR Report)
Antenna Requirement	15.203/15.247 (c)	Pass
AC Power Line Conducted Emission	15.207	Pass
Conducted Peak Output Power	15.247 (b)(1)	Pass
20dB Occupied Bandwidth	15.247 (a)(1)	Pass
Carrier Frequencies Separation	15.247 (a)(1)	Pass
Hopping Channel Number	15.247 (a)(1)	Pass
Dwell Time	15.247 (a)(1)	Pass
Pseudorandom Frequency Hopping Sequence	15.247(b)(4)	Pass
Radiated Emission	15.205/15.209	Pass
Band Edge	15.247(d)	Pass

Pass: The EUT complies with the essential requirements in the standard.

Remark: Test according to ANSI C63.10:2013

3. RF Exposure

3.1 Standard Applicable

According to § 1.1307 and § 2.1093, the portable transmitter must comply the RF exposure requirements.

3.2 Test Result

This product complied with the requirement of the RF exposure, please see the RF Exposure Report.

4. Antenna Requirement

4.1 Standard Applicable

According to FCC Part 15.203, an intentional radiator shall be designed to ensure that no antenna other than that furnished by the responsible party shall be used with the device. The use of a permanently attached antenna or of an antenna that uses a unique coupling to the intentional radiator shall be considered sufficient to comply with the provisions of this section.

4.2 Evaluation Information

This product has a Ceramic antenna(0dBi), fulfill the requirement of this section.

5. Conducted Emissions

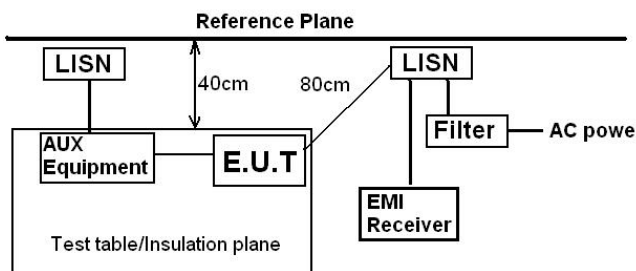
Test Requirement:	FCC Part15 C Section 15.207														
Test Method:	ANSI C63.10:2013														
Test Frequency Range:	150KHz to 30MHz														
Class / Severity:	Class B														
Receiver setup:	RBW=9KHz, VBW=30KHz, Sweep time=auto														
Limit:	<table border="1"> <thead> <tr> <th rowspan="2">Frequency range (MHz)</th> <th colspan="2">Limit (dBuV)</th> </tr> <tr> <th>Quasi-peak</th> <th>Average</th> </tr> </thead> <tbody> <tr> <td>0.15-0.5</td> <td>66 to 56*</td> <td>56 to 46*</td> </tr> <tr> <td>0.5-5</td> <td>56</td> <td>46</td> </tr> <tr> <td>5-30</td> <td>60</td> <td>50</td> </tr> </tbody> </table> <p>* Decreases with the logarithm of the frequency.</p>	Frequency range (MHz)	Limit (dBuV)		Quasi-peak	Average	0.15-0.5	66 to 56*	56 to 46*	0.5-5	56	46	5-30	60	50
Frequency range (MHz)	Limit (dBuV)														
	Quasi-peak	Average													
0.15-0.5	66 to 56*	56 to 46*													
0.5-5	56	46													
5-30	60	50													
Test setup:	 <p><i>Remark</i> E.U.T: Equipment Under Test LISN: Line Impedance Stabilization Network Test table height=0.8m</p>														
Test procedure:	<ol style="list-style-type: none"> 1. The E.U.T and simulators are connected to the main power through a line impedance stabilization network (L.I.S.N.). This provides a 50ohm/50uH coupling impedance for the measuring equipment. 2. The peripheral devices are also connected to the main power through a LISN that provides a 50ohm/50uH coupling impedance with 50ohm termination. (Please refer to the block diagram of the test setup and photographs). 3. Both sides of A.C. line are checked for maximum conducted interference. In order to find the maximum emission, the relative positions of equipment and all of the interface cables must be changed according to ANSI C63.10:2013 on conducted measurement. 														
Test Instruments:	Refer to section 1.7 for details														
Test mode:	Refer to section 1.2 for details														
Test results:	Pass														

The equipment is battery powered, so do not test this item

Notes:

1. An initial pre-scan was performed on the line and neutral lines with peak detector.
2. Quasi-Peak and Average measurement were performed at the frequencies with maximized peak emission.
3. Final Level =Receiver Read level + LISN Factor + Cable Loss

6. Conducted Peak Output Power

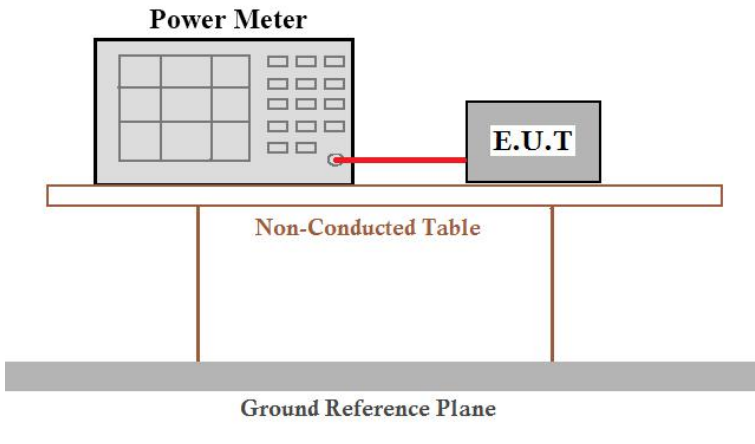
Test Requirement:	FCC Part15 C Section 15.247 (b)(3)
Test Method:	ANSI C63.10:2013
Limit:	30dBm(for GFSK),20.97dBm(for EDR)
Test setup:	 <p>The diagram illustrates the test setup. A Power Meter is connected to an E.U.T. (Equipment Under Test) via a red cable. Both are placed on a Non-Conducted Table, which is supported by a Ground Reference Plane.</p>
Test Instruments:	Refer to section 1.7 for details
Test mode:	Refer to section 1.2 for details
Test results:	Pass

Measurement Data: The result is a test of the left earbuds

Mode	Test channel	Peak Output Power (dBm)	Limit (dBm)	Result
GFSK	Lowest	-2.32	30.00	Pass
	Middle	-1.37		
	Highest	-1.06		
Pi/4QPSK	Lowest	-3.16	20.97	Pass
	Middle	-2.23		
	Highest	-1.87		
8DPSK	Lowest	-2.97	20.97	Pass
	Middle	-2.02		
	Highest	-2.07		

7. 20dB Emission Bandwidth

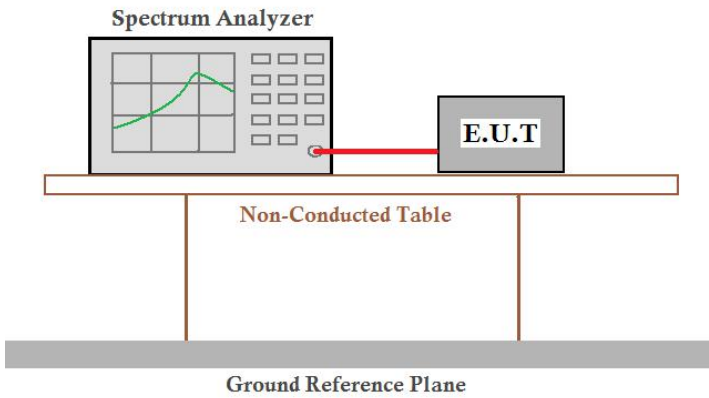
Test Requirement:	FCC Part15 C Section 15.247 (a)(2)
Test Method:	ANSI C63.10:2013
Limit:	N/A
Test setup:	 <p>The diagram illustrates the test setup. A Spectrum Analyzer is connected to an E.U.T. (Equipment Under Test) via a red cable. Both are placed on a Non-Conducted Table, which is supported by a Ground Reference Plane.</p>
Test Instruments:	Refer to section 1.7 for details
Test mode:	Refer to section 1.2 for details
Test results:	Pass

Measurement Data: The result is a test of the left earbuds

Mode	Test channel	20dB Emission Bandwidth (MHz)	Result
GFSK	Lowest	0.906	Pass
	Middle	0.900	
	Highest	0.900	
Pi/4QPSK	Lowest	1.128	Pass
	Middle	1.128	
	Highest	1.128	
8DPSK	Lowest	1.158	Pass
	Middle	1.158	
	Highest	1.158	

Test plot as follows:

Test mode:	GFSK mode
------------	-----------

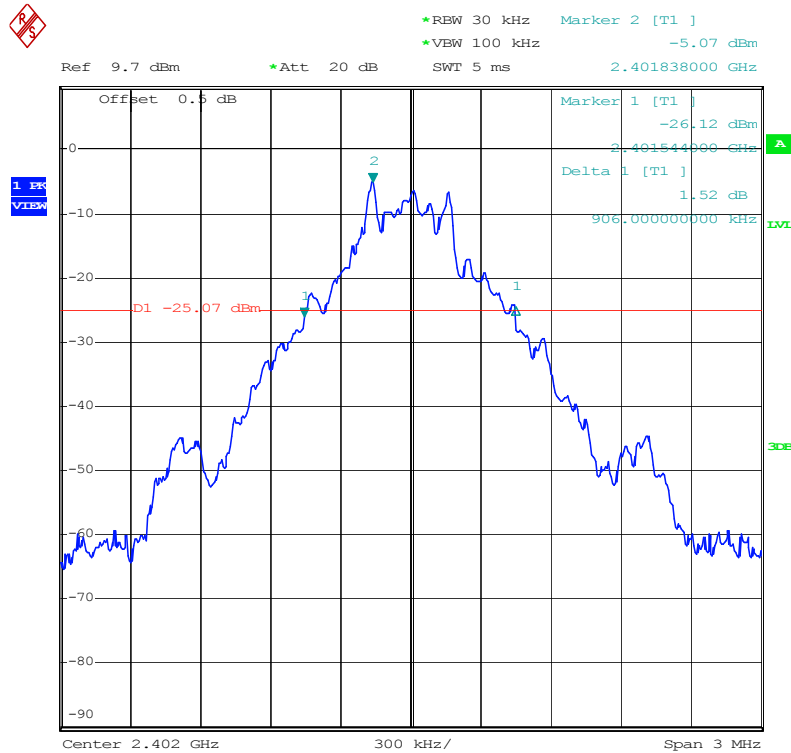

Lowest channel

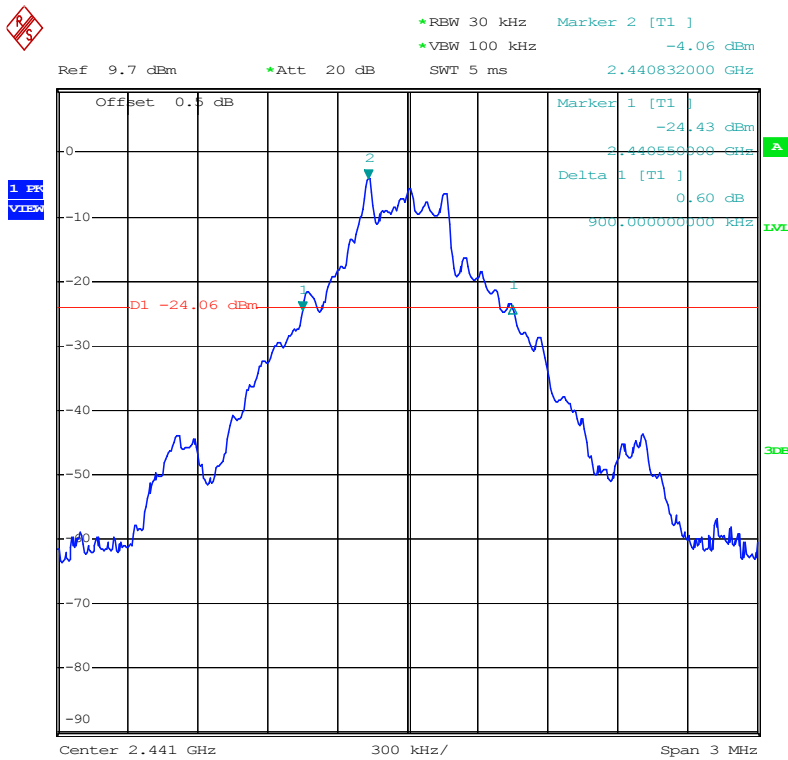

Middle channel

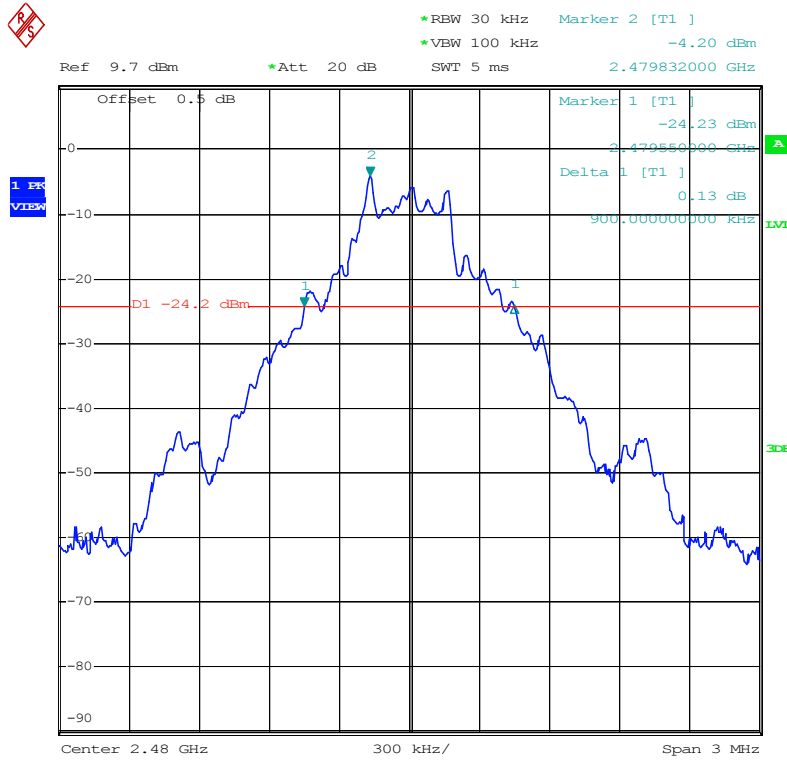

Highest channel

Test mode: Pi/4QPSK mode

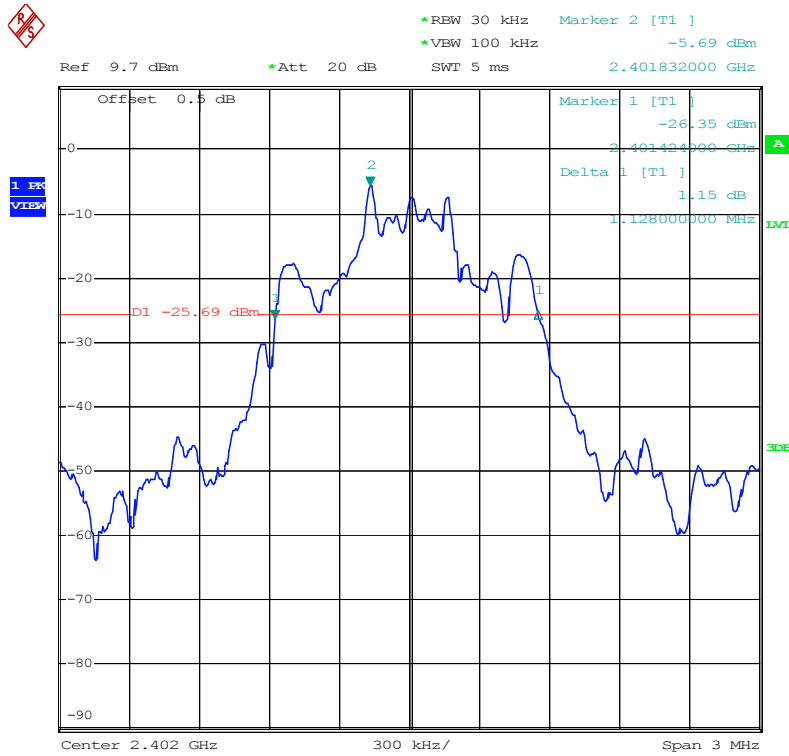

Lowest channel

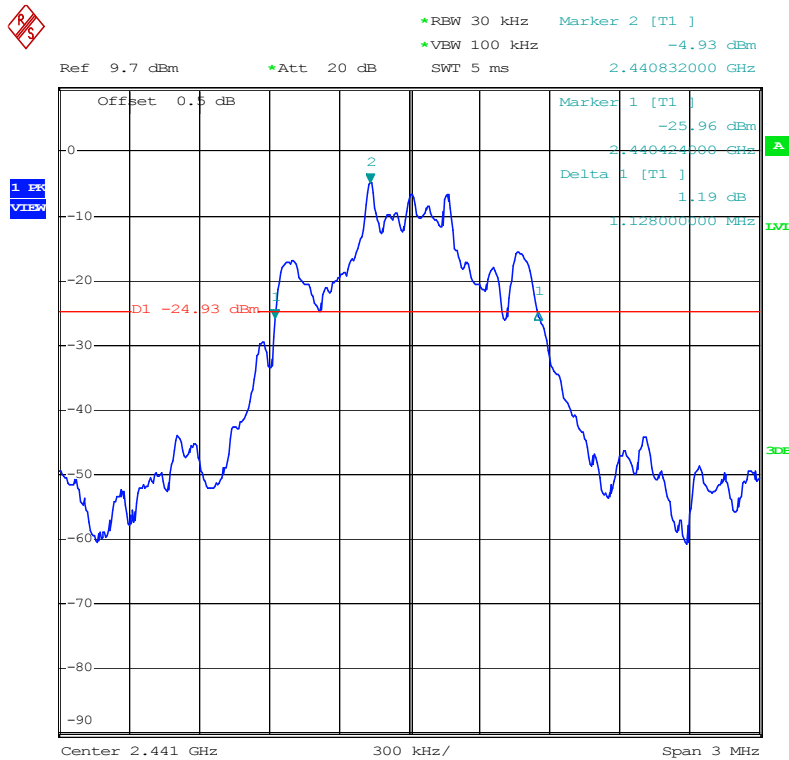

Middle channel

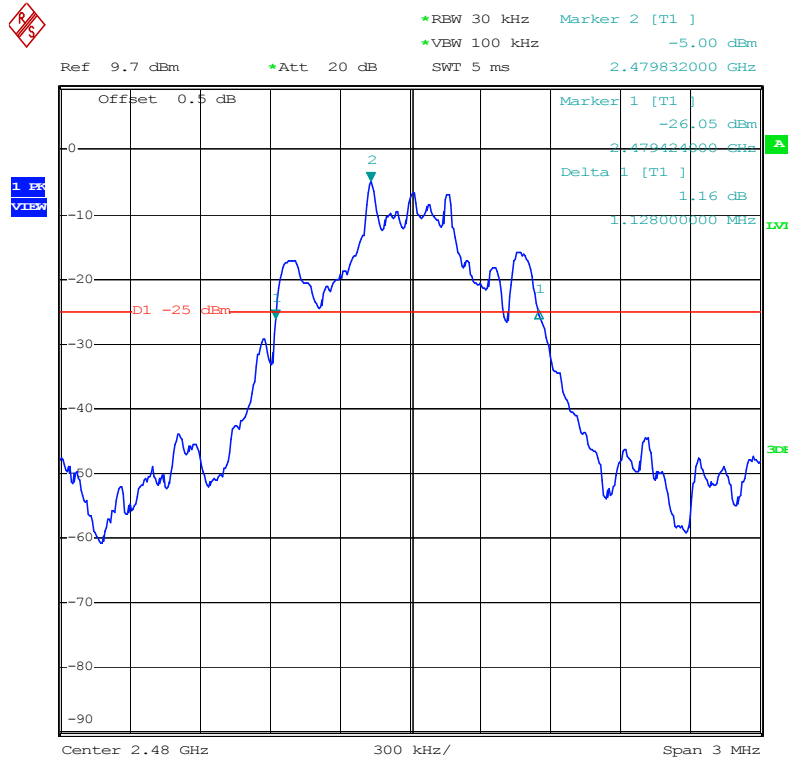

Highest channel

Test mode: 8DPSK mode

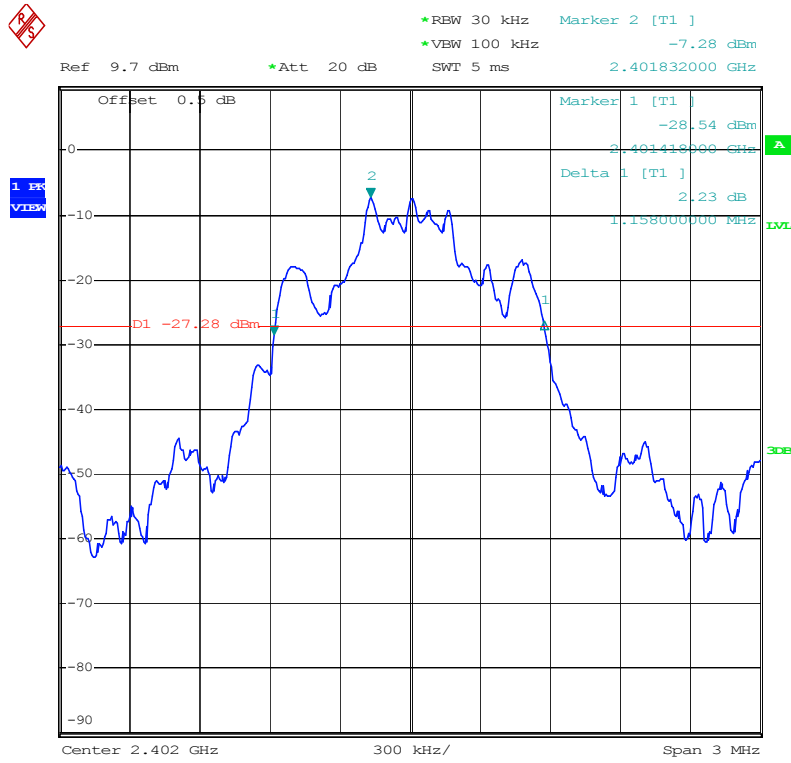

Lowest channel

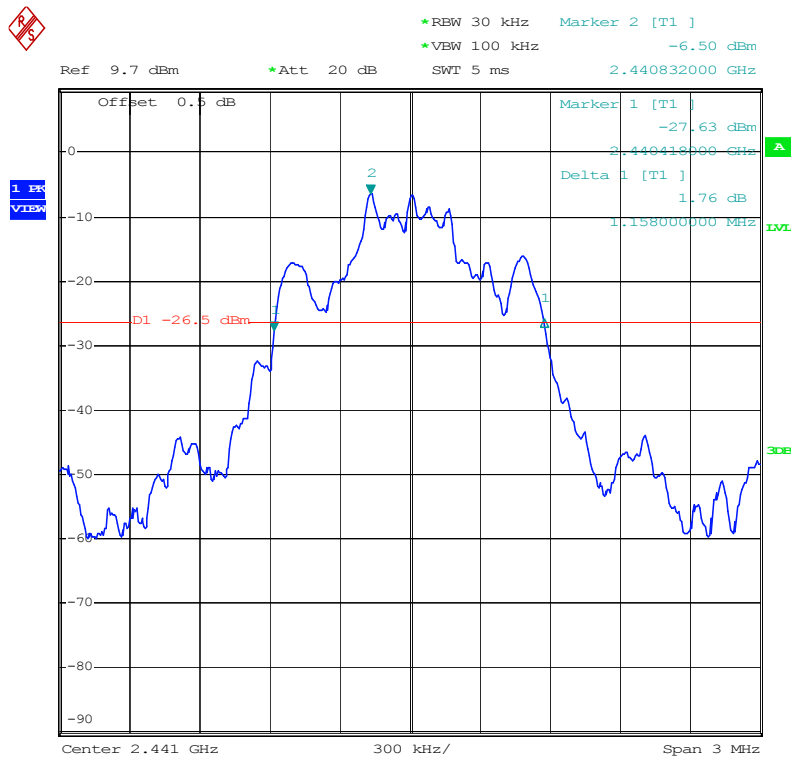

Middle channel

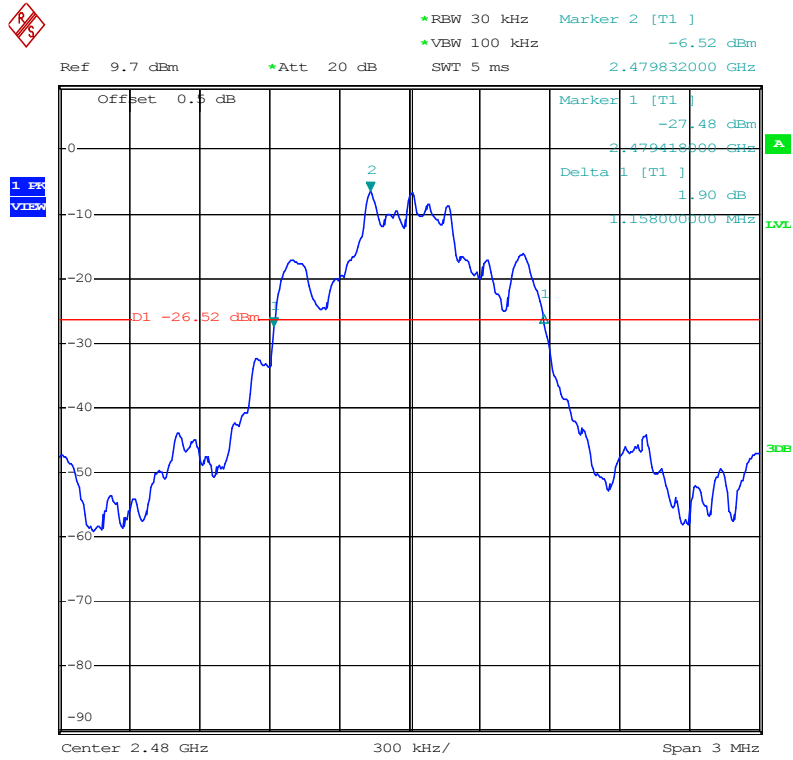

Highest channel

8. Carrier Frequencies Separation

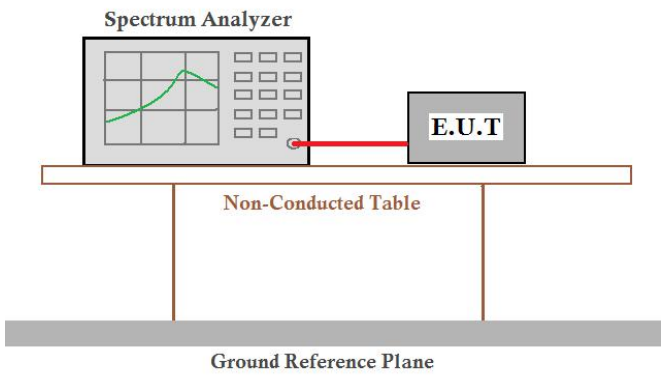
Test Requirement:	FCC Part15 C Section 15.247 (a)(1)
Test Method:	ANSI C63.10:2013
Receiver setup:	RBW=20KHz, VBW=62KHz, detector=Peak
Limit:	0.025MHz or 2/3 of the 20dB bandwidth (whichever is greater)
Test setup:	
Test Instruments:	Refer to section 1.7 for details
Test mode:	Refer to section 1.2 for details
Test results:	Pass

Measurement Data: The result is a test of the left earbuds

Mode	Test channel	Carrier Frequencies Separation (kHz)	Limit (kHz)	Result
GFSK	Lowest	1002	623	Pass
	Middle	1008	623	Pass
	Highest	1008	623	Pass
Pi/4QPSK	Lowest	1002	841	Pass
	Middle	1008	841	Pass
	Highest	1008	841	Pass
8DSK	Lowest	1002	817	Pass
	Middle	1002	817	Pass
	Highest	1002	817	Pass

Note: According to section 7.4

Mode	20dB bandwidth (kHz) (worse case)	Limit (kHz) (Carrier Frequencies Separation)
GFSK	900.00	623
Pi/4QPSK	1128.00	841
8DSK	1158.00	817

Test plot as follows:

Only show the worst case

GFSK

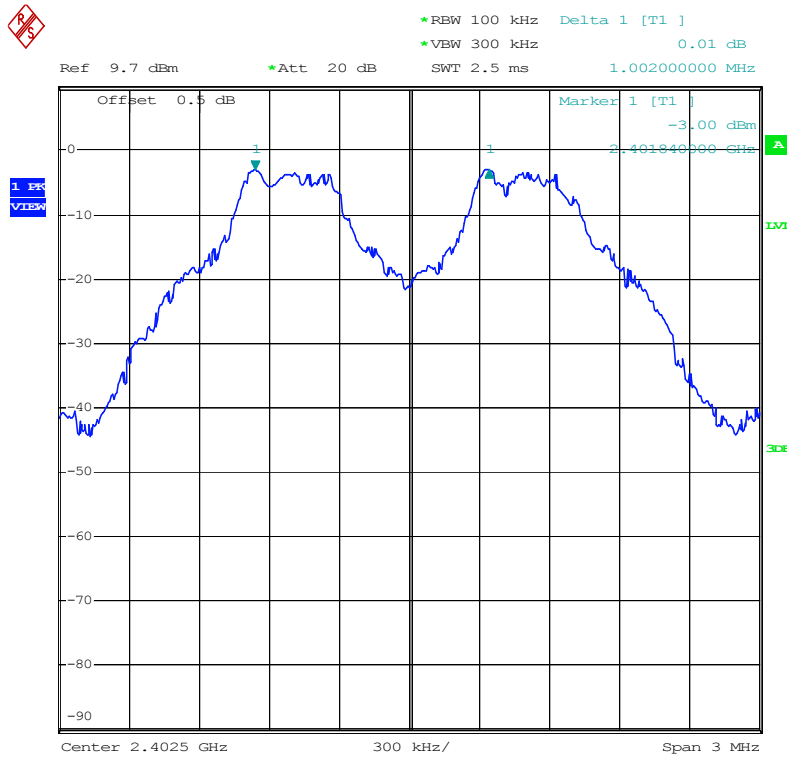

π /4DQPSK

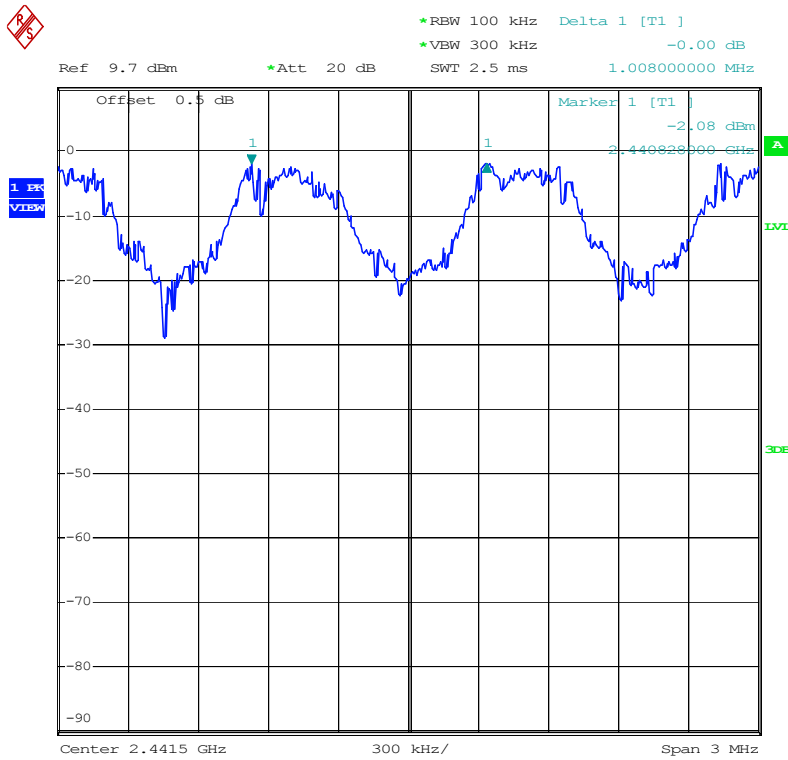

8DPSK

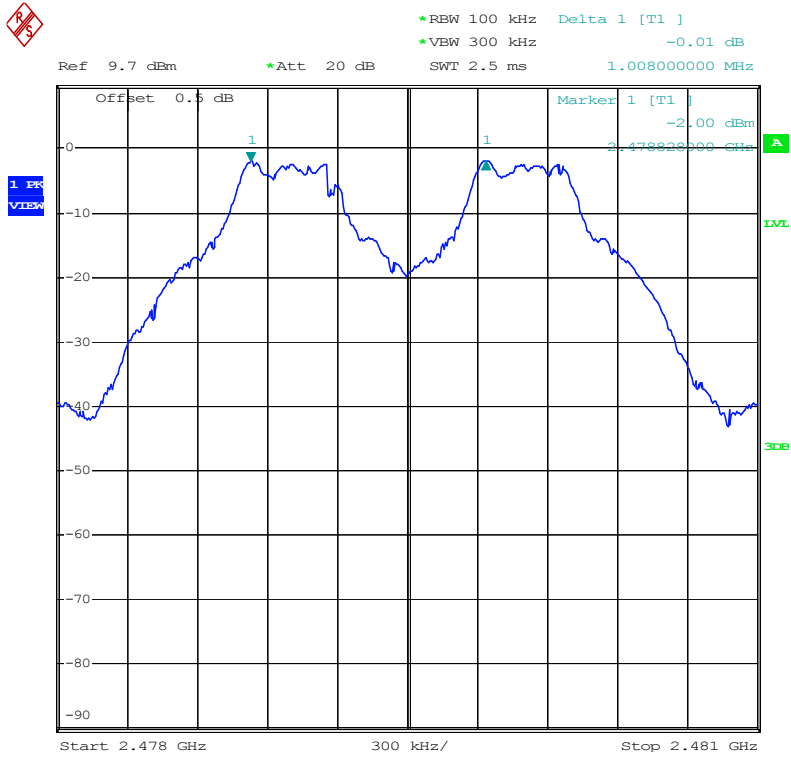

9. Hopping Channel Number

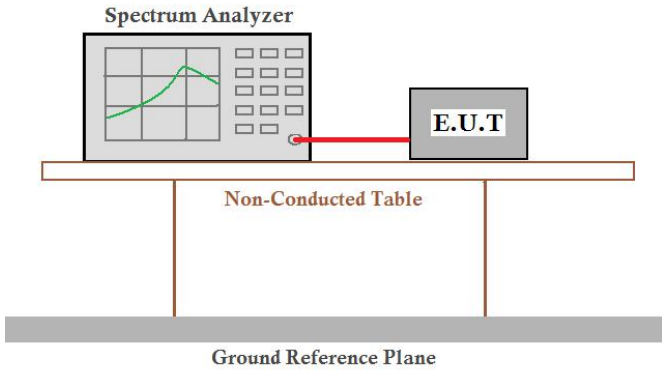
Test Requirement:	FCC Part15 C Section 15.247 (a)(1)
Test Method:	ANSI C63.10:2013
Receiver setup:	RBW=100kHz, VBW=300kHz, Frequency range=2400MHz-2483.5MHz, Detector=Peak
Limit:	15 channels
Test setup:	 <p>The diagram illustrates the test setup. A Spectrum Analyzer is connected to an E.U.T. (Equipment Under Test) via a red cable. Both are placed on a Non-Conducted Table, which is supported by a Ground Reference Plane.</p>
Test Instruments:	Refer to section 1.7 for details
Test mode:	Refer to section 1.2 for details
Test results:	Pass

Measurement Data: The result is a test of the left earbuds

Mode	Hopping channel numbers	Limit	Result
GFSK	79	15	Pass
Pi/4QPSK	79	15	Pass
8DPSK	79	15	Pass

GFSK

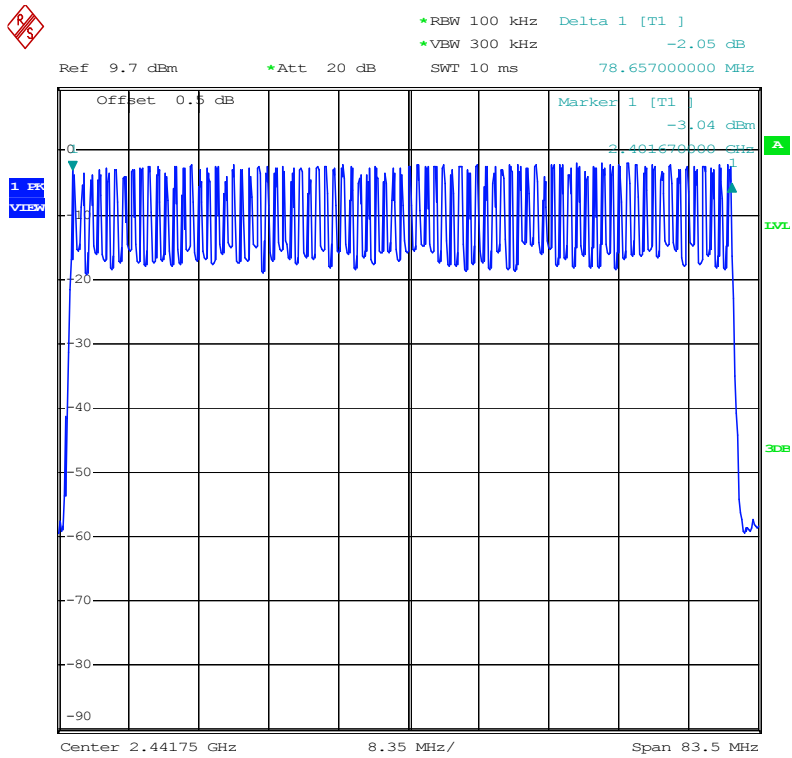

$\pi/4$ DQPSK

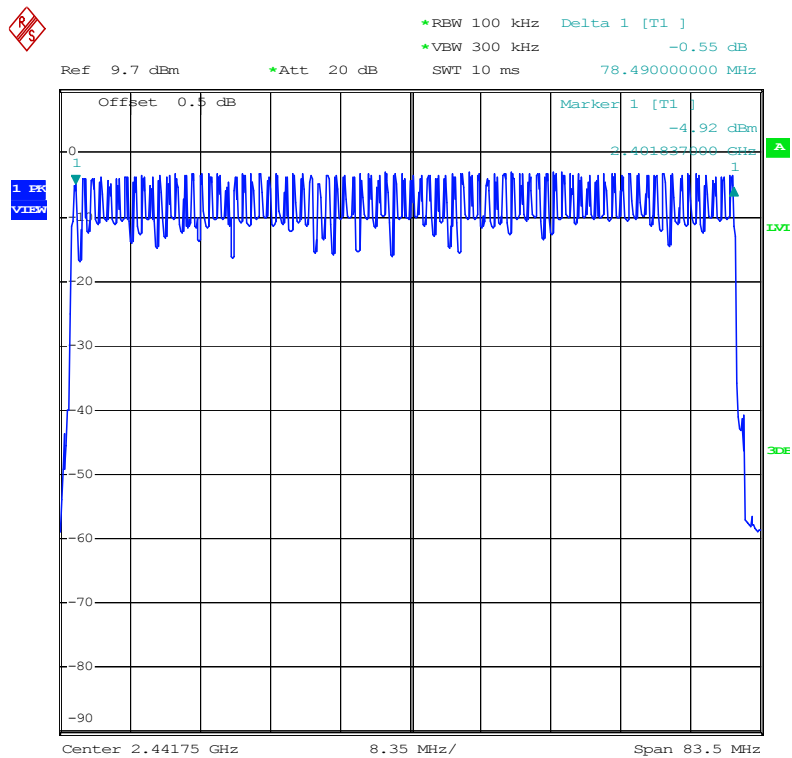

8DPSK

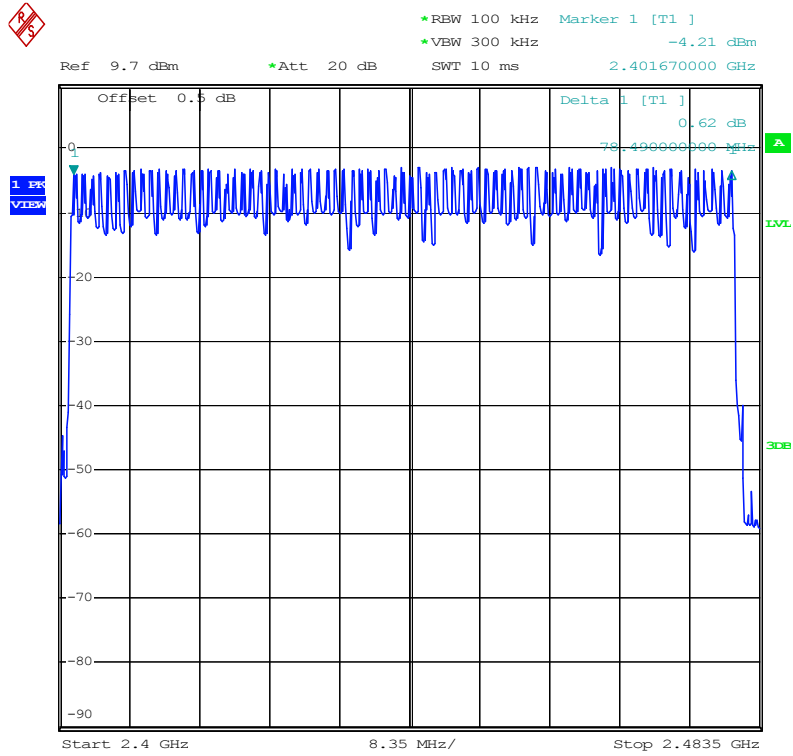

10. Dwell Time

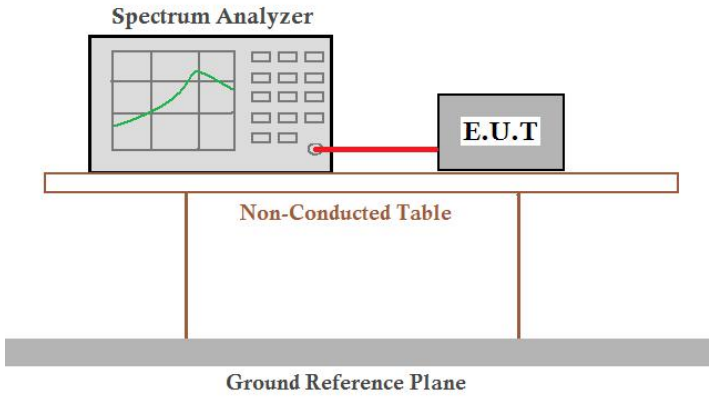
Test Requirement:	FCC Part15 C Section 15.247 (a)(1)
Test Method:	ANSI C63.10:2013
Receiver setup:	RBW=1MHz, VBW=1MHz, Span=0Hz, Detector=Peak
Limit:	0.4 Second
Test setup:	
Test Instruments:	Refer to section 1.7 for details
Test mode:	Refer to section 1.2 for details
Test results:	Pass

Measurement Data: The result is a test of the left earbuds

Mode	Frequency (MHz)	Burst Type	Pulse Width (ms)	Dwell Time (ms)	Limit (ms)	Verdict
GFSK	2441	DH1	0.400	128.00	400	PASS
		DH3	1.660	265.60		
		DH5	2.910	310.40		
π/4-DQPSK	2441	DH1	0.410	131.20	400	PASS
		DH3	1.100	176.00		
		DH5	2.910	310.40		
8DPSK	2441	DH1	0.410	131.20	400	PASS
		DH3	1.660	265.60		
		DH5	2.920	311.47		

The test period: $T = 0.4 \text{ Second/Channel} \times 79 \text{ Channel} = 31.6 \text{ s}$

Test channel: 2402MHz/2441MHz/2480MHz as blow

DH1 time slot= Pulse time (ms)*(1600/ (2*79))*31.6

DH3 time slot= Pulse time (ms)*(1600/ (4*79))*31.6

DH5 time slot= Pulse time (ms)*(1600/ (6*79))*31.6

Test plot as follows:

Dwell time

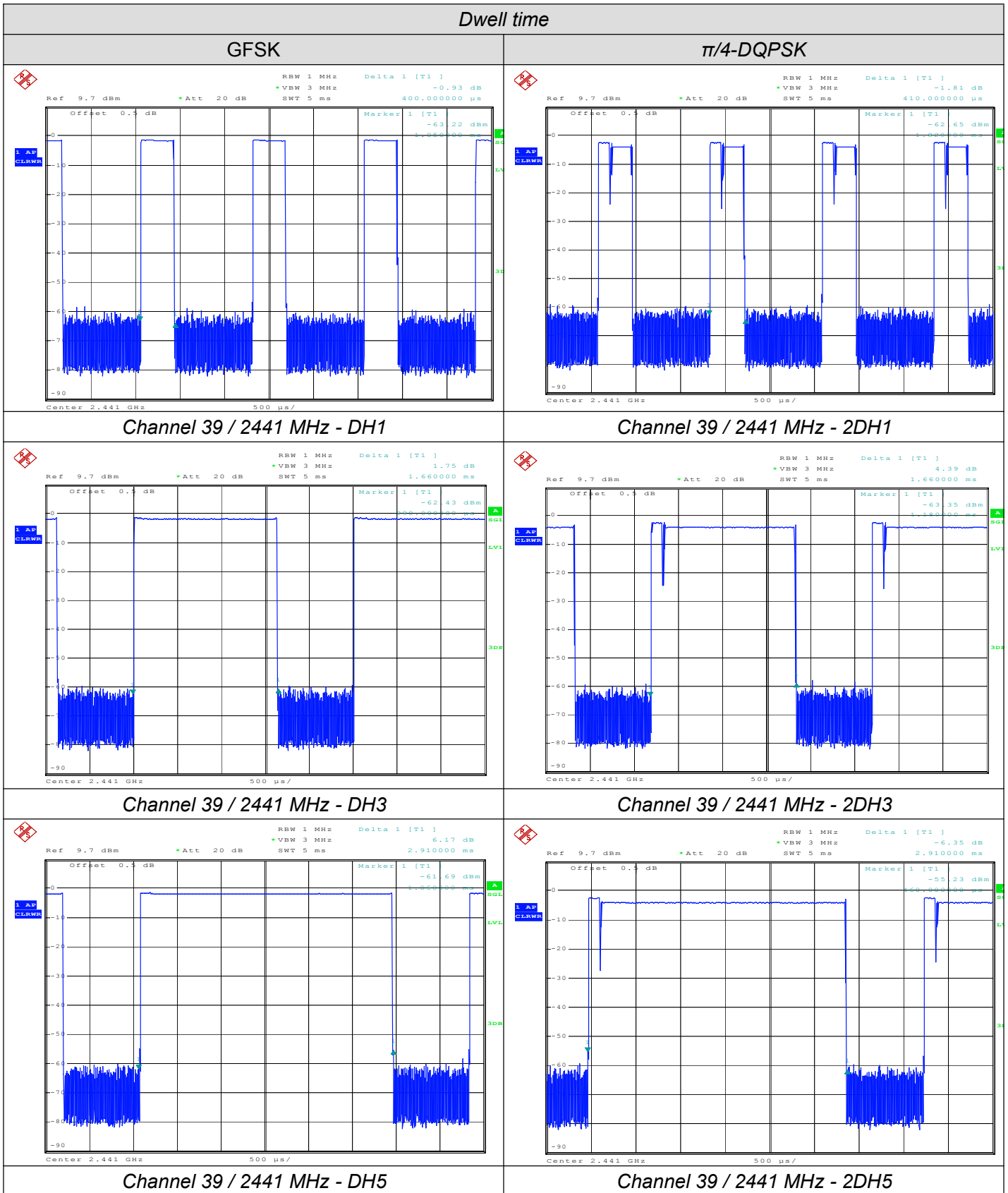

Dwell time

8DPSK

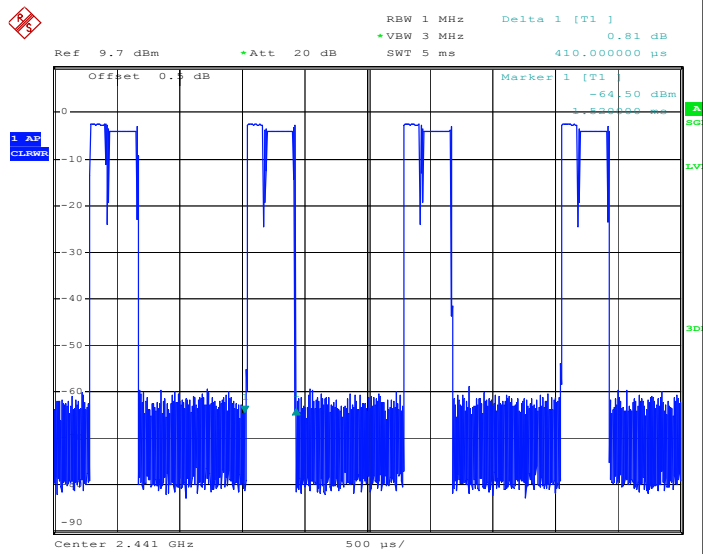

Channel 39 / 2441 MHz - 3DH1

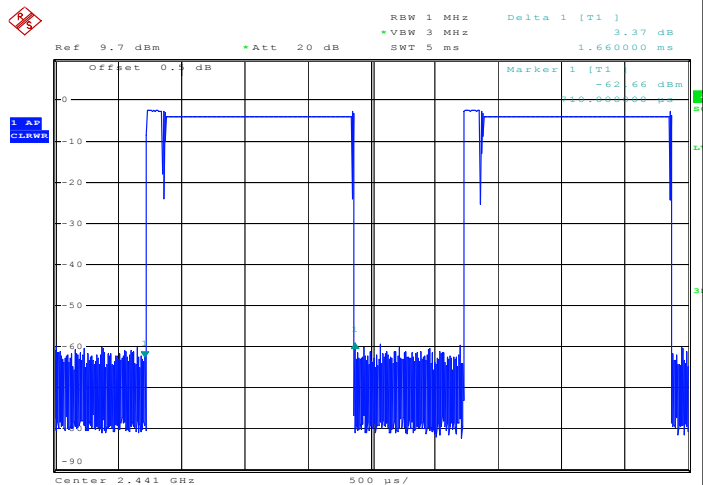

2 Channel 39 / 2441 MHz - 3DH3

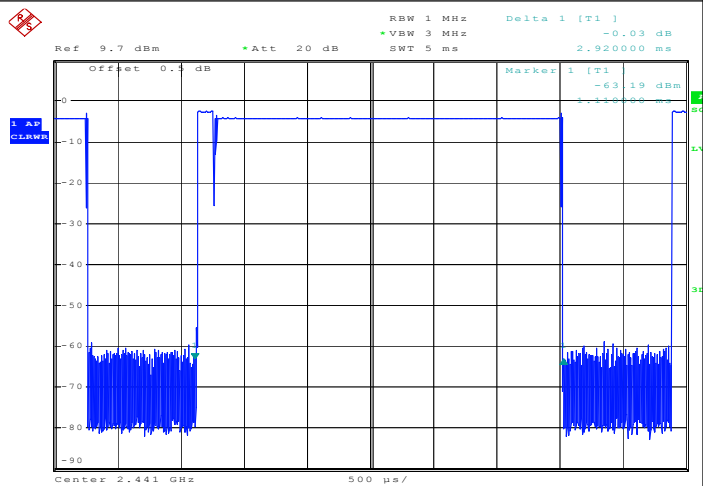

Channel 39 / 2441 MHz - 3DH5

11. Pseudorandom Frequency Hopping Sequence

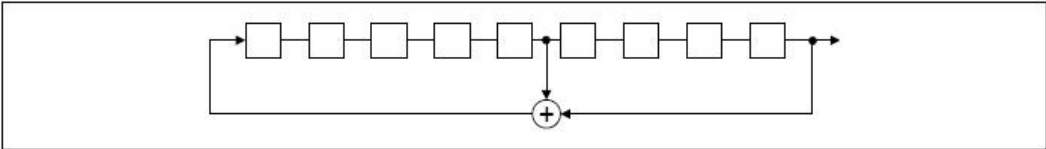
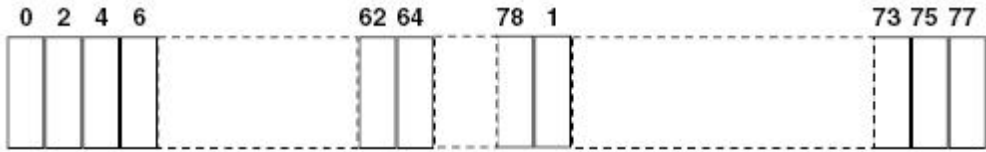
Test Requirement:	FCC Part15 C Section 15.247 (a)(1) requirement:
<p><i>Frequency hopping systems shall have hopping channel carrier frequencies separated by a minimum of 25 kHz or the 20 dB bandwidth of the hopping channel, whichever is greater.</i></p> <p><i>Alternatively. Frequency hopping systems operating in the 2400-2483.5 MHz band may have hopping channel carrier frequencies that are separated by 25 kHz or two-thirds of the 20 dB bandwidth of the hopping channel, whichever is greater, provided the systems operate with an output power no greater than 125 mW. The system shall hop to channel frequencies that are selected at the system hopping rate from a Pseudorandom ordered list of hopping frequencies. Each frequency must be used equally on the average by each transmitter. The system receivers shall have input bandwidths that match the hopping channel bandwidths of their corresponding transmitters and shall shift frequencies in synchronization with the transmitted signals.</i></p>	
<p>EUT Pseudorandom Frequency Hopping Sequence</p>	
<p><i>The pseudorandom sequence may be generated in a nine-stage shift register whose 5th and 9th stage outputs are added in a modulo-two addition stage. And the result is fed back to the input of the first stage. The sequence begins with the first ONE of 9 consecutive ONES; i.e. the shift register is initialized with nine ones.</i></p> <ul style="list-style-type: none"> • Number of shift register stages: 9 • Length of pseudo-random sequence: $2^9 - 1 = 511$ bits • Longest sequence of zeros: 8 (non-inverted signal) 	
	
<p style="text-align: center;"><i>Linear Feedback Shift Register for Generation of the PRBS sequence</i></p>	
<p><i>An example of Pseudorandom Frequency Hopping Sequence as follow:</i></p>	
	
<p><i>Each frequency used equally on the average by each transmitter.</i></p> <p><i>The system receivers have input bandwidths that match the hopping channel bandwidths of their corresponding transmitters and shift frequencies in synchronization with the transmitted signals.</i></p>	

12. Band Edge

Conducted Emission Method

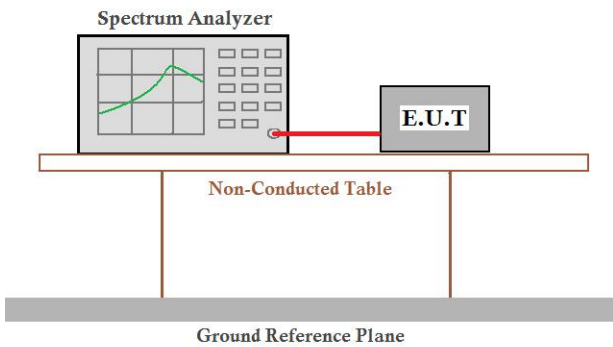
Test Requirement:	FCC Part15 C Section 15.247 (d)
Test Method:	ANSI C63.10:2013
Receiver setup:	RBW=100kHz, VBW=300kHz, Detector=Peak
Limit:	In any 100 kHz bandwidth outside the frequency band in which the spread spectrum intentional radiator is operating, the radio frequency power that is produced by the intentional radiator shall be at least 20 dB below that in the 100 kHz bandwidth within the band that contains the highest level of the desired power, based on either an RF conducted or a radiated measurement.
Test setup:	 <p>The diagram illustrates the test setup. A Spectrum Analyzer is connected to an E.U.T. (Equipment Under Test) via a red cable. Both are placed on a Non-Conducted Table, which is supported by two legs. Below the table is a Ground Reference Plane.</p>
Test Instruments:	Refer to section 1.7 for details
Test mode:	Refer to section 1.2 for details
Test results:	Pass

Test plot as follows: The result is a test of the left earbuds

GFSK Mode:

Test channel:
Lowest channel

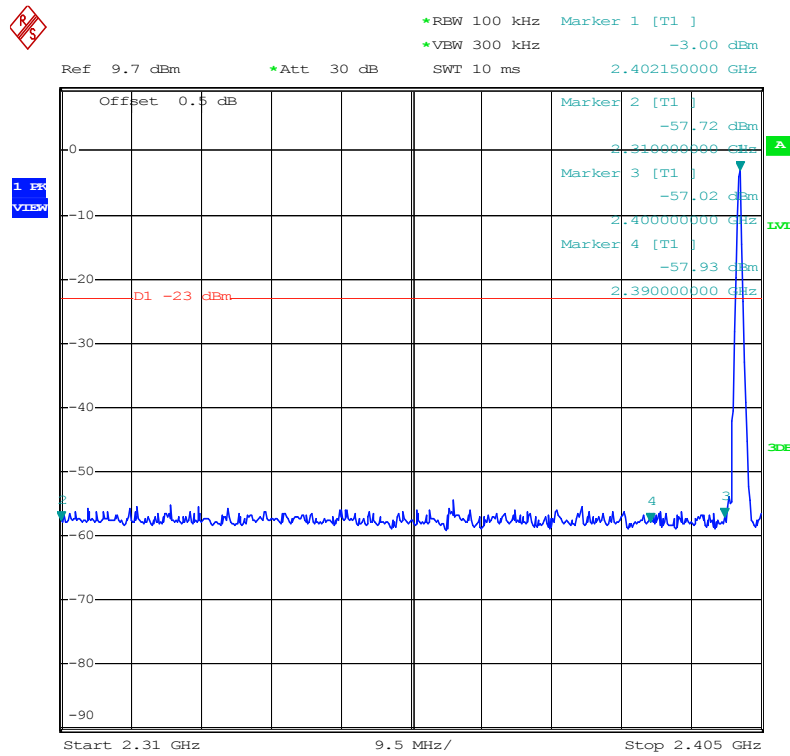

Test channel:
Highest channel

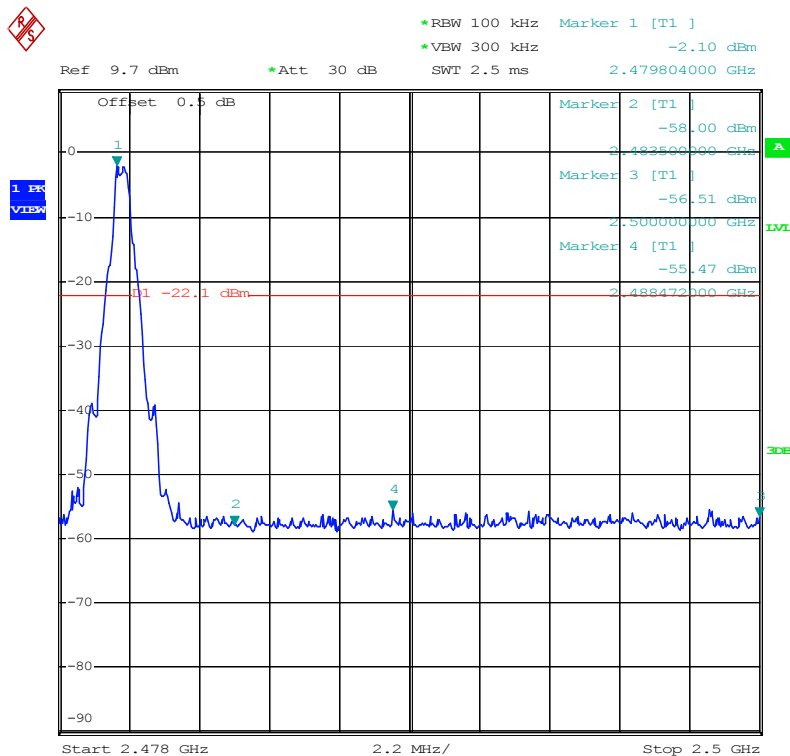

Pi/4QPSK Mode:

Test channel:
Lowest channel

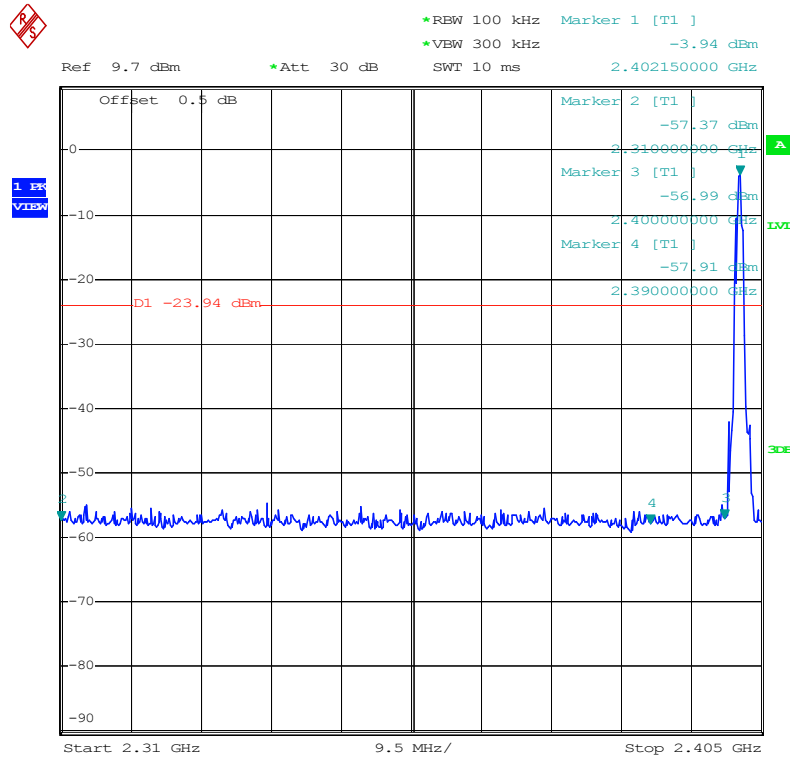

Test channel:
Highest channel

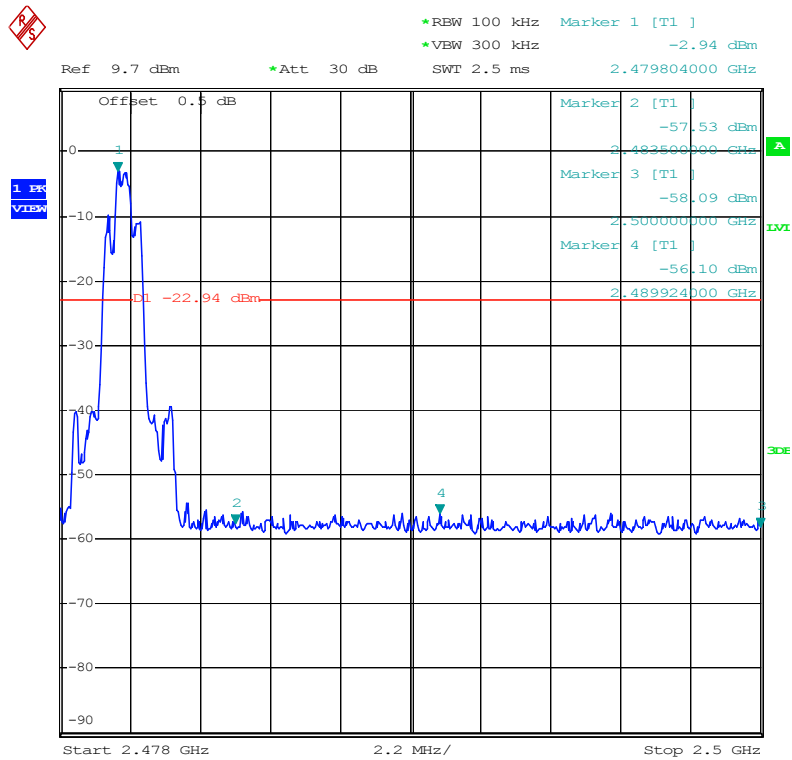

8DPSK Mode:

Test channel:
Lowest channel

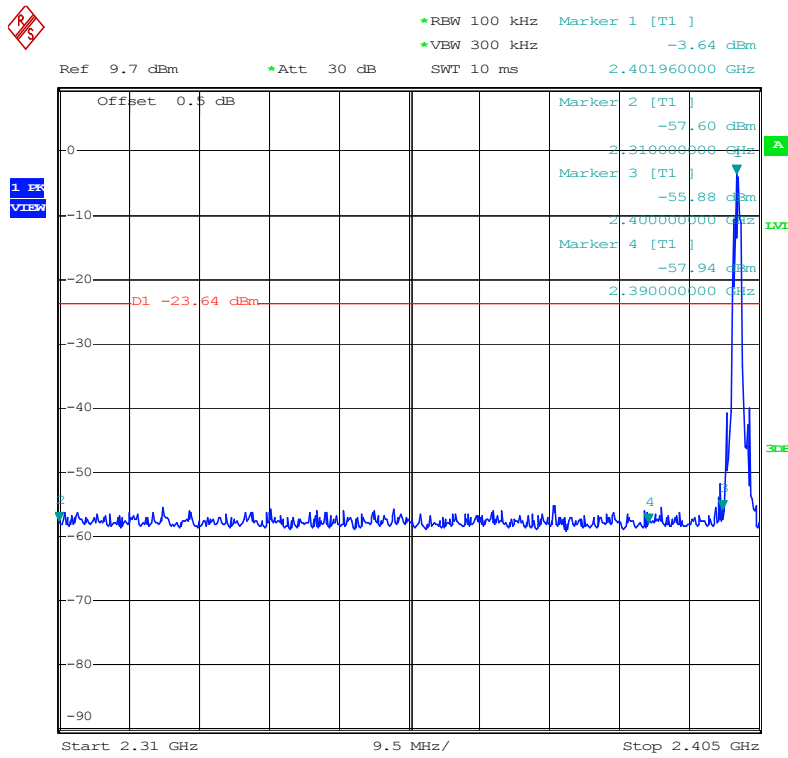

Test channel:
Highest channel

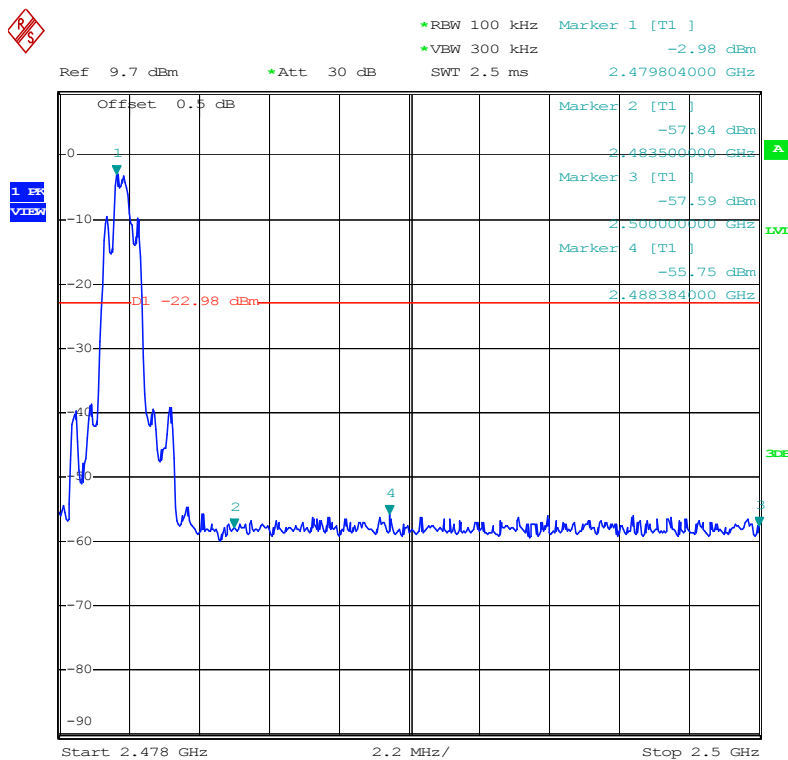

Radiated Emission Method

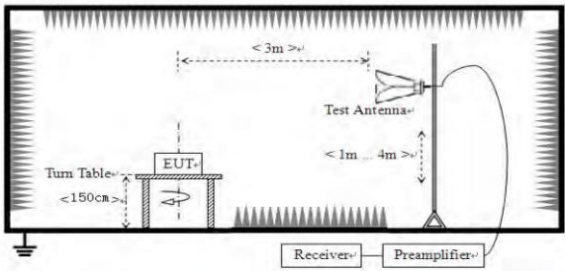
Test Requirement:	FCC Part15 C Section 15.209 and 15.205				
Test Method:	ANSI C63.10:2013				
Test Frequency Range:	All restriction band have been tested, and 2.31GHz to 2.5GHz band is the worse case				
Test site:	Measurement Distance: 3m				
Receiver setup:	Frequency	Detector	RBW	VBW	Remark
	Above 1GHz	Peak	1MHz	3MHz	Peak Value
		Peak	1MHz	10Hz	Average Value
Limit:	Frequency		Limit (dBuV/m @3m)		Remark
	Above 1GHz		54.00		Average Value
			74.00		Peak Value
Test setup:					
Test Procedure:	<ol style="list-style-type: none"> 1. The EUT was placed on the top of a rotating table 1.5 meters above the ground at a 3 meter camber. The table was rotated 360 degrees to determine the position of the highest radiation. 2. The EUT was set 3 meters away from the interference-receiving antenna, which was mounted on the top of a variable-height antenna tower. 3. The antenna height is varied from one meter to four meters above the ground to determine the maximum value of the field strength. Both horizontal and vertical polarizations of the antenna are set to make the measurement. 4. For each suspected emission, the EUT was arranged to its worst case and then the antenna was tuned to heights from 1 meter to 4 meters and the rota table was turned from 0 degrees to 360 degrees to find the maximum reading. 5. The test-receiver system was set to Peak Detect Function and Specified Bandwidth with Maximum Hold Mode. 6. If the emission level of the EUT in peak mode was 10dB lower than the limit specified, then testing could be stopped and the peak values of the EUT would be reported. Otherwise the emissions that did not have 10dB margin would be re-tested one by one using peak, quasi-peak or average method as specified and then reported in a data sheet. 				
Test Instruments:	Refer to section 1.7 for details				
Test mode:	Refer to section 1.2 for details				
Test results:	Pass				

Remark: During the test, pre-scan the GFSK, Pi/4QPSK, 8DPSK modulation, and found the GFSK modulation

which it is worse case.

Test channel:	Lowest
---------------	--------

Peak value:

Frequency (MHz)	Level (dBuV/m)	Limit Line (dBuV/m)	Over Limit (dB)	Polarization
2390.00	52.77	74.00	-21.23	Horizontal
2400.00	55.38	74.00	-18.62	Horizontal
2390.00	51.26	74.00	-22.74	Vertical
2400.00	56.23	74.00	-17.77	Vertical

Average value:

Frequency (MHz)	Level (dBuV/m)	Limit Line (dBuV/m)	Over Limit (dB)	Polarization
2390.00	41.58	54.00	-12.42	Horizontal
2400.00	42.64	54.00	-11.36	Horizontal
2390.00	41.32	54.00	-12.68	Vertical
2400.00	42.59	54.00	-11.41	Vertical

Test channel:	Highest
---------------	---------

Peak value:

Frequency (MHz)	Level (dBuV/m)	Limit Line (dBuV/m)	Over Limit (dB)	Polarization
2483.50	53.37	74.00	-20.63	Horizontal
2500.00	52.49	74.00	-21.51	Horizontal
2483.50	55.28	74.00	-18.72	Vertical
2500.00	54.65	74.00	-19.35	Vertical

Average value:

Frequency (MHz)	Level (dBuV/m)	Limit Line (dBuV/m)	Over Limit (dB)	Polarization
2483.50	41.72	54.00	-12.28	Horizontal
2500.00	42.68	54.00	-11.32	Horizontal
2483.50	44.35	54.00	-9.65	Vertical
2500.00	42.22	54.00	-11.78	Vertical

Remark:

1. Final Level = Receiver Read level + Antenna Factor + Cable Loss – Preamplifier Factor
2. The emission levels of other frequencies are very lower than the limit and not show in test report.

14. Spurious Emission

Conducted Emission Method

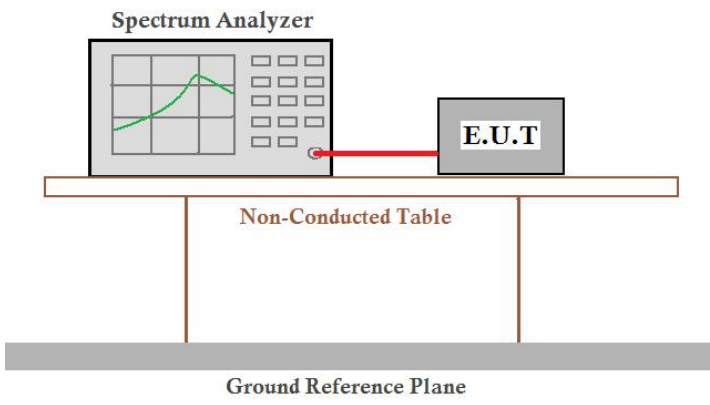
Test Requirement:	FCC Part15 C Section 15.247 (d)
Test Method:	ANSI C63.10:2013
Limit:	In any 100 kHz bandwidth outside the frequency band in which the spread spectrum intentional radiator is operating, the radio frequency power that is produced by the intentional radiator shall be at least 20 dB below that in the 100 kHz bandwidth within the band that contains the highest level of the desired power, based on either an RF conducted or a radiated measurement.
Test setup:	 <p>The diagram illustrates the test setup. A Spectrum Analyzer is connected to an E.U.T. (Equipment Under Test) via a red cable. Both are placed on a Non-Conducted Table, which is supported by a Ground Reference Plane.</p>
Test Instruments:	Refer to section 1.7 for details
Test mode:	Refer to section 1.2 for details
Test results:	Pass

Remark:

During the test, pre-scan the GFSK, Pi/4QPSK, 8DPSK modulation, and found the GFSK modulation which it is worse case. The result is a test of the left earbuds

Test channel: GFSK



Ref 9.7 dBm *Att 30 dB SWT 2.7 s 25.166040000 GHz
*RBW 100 kHz Marker 1 [T1]
*VBW 300 kHz -42.33 dBm

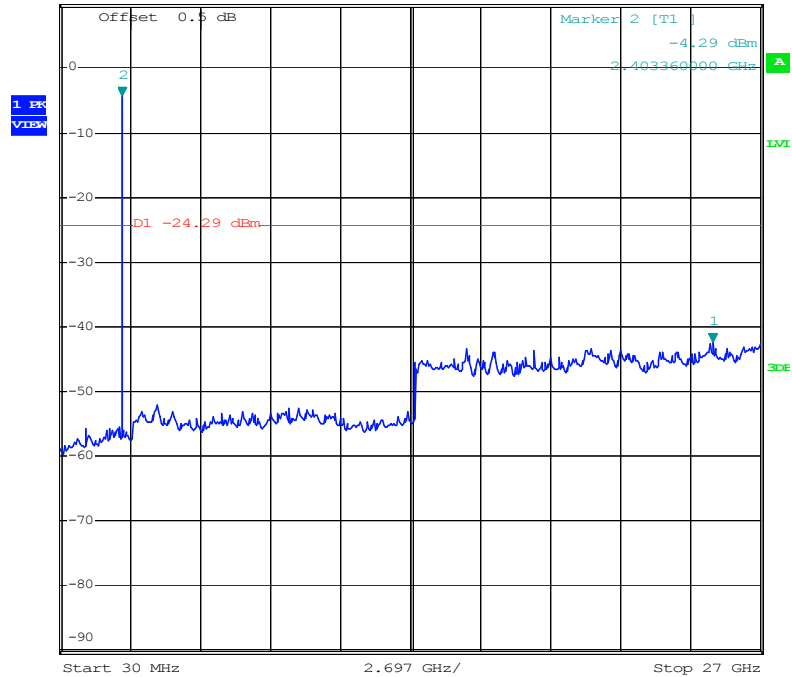

Test channel: 4QPSK

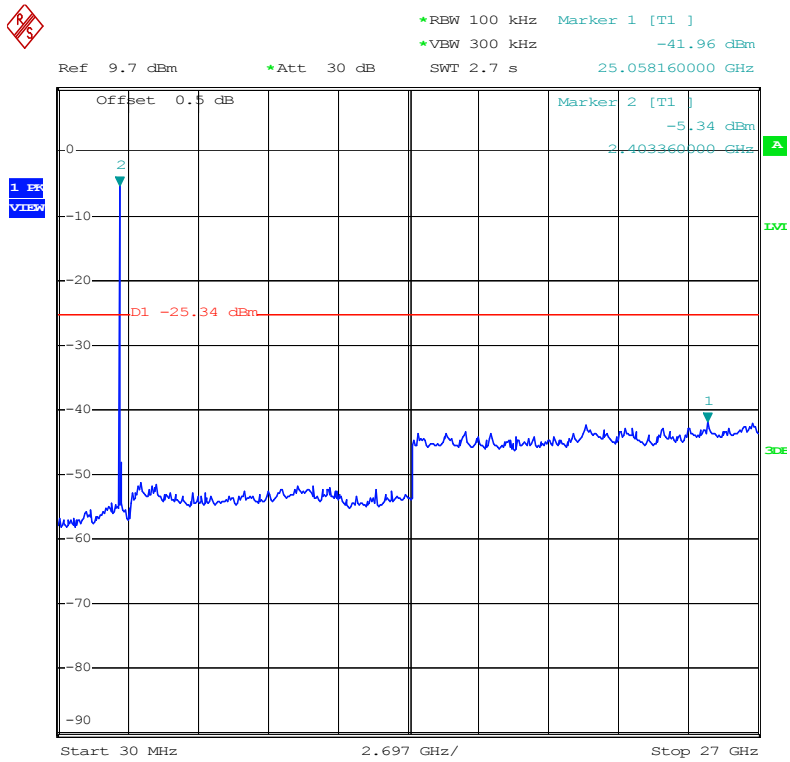

Test channel: 8DPSK

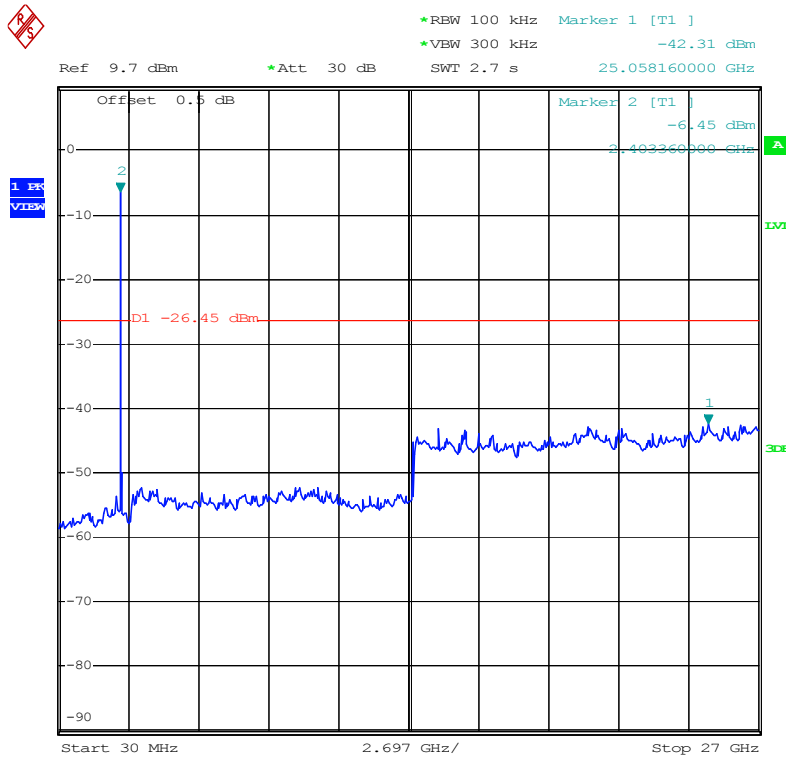

Radiated Emission Method

Test Requirement:	FCC Part15 C Section 15.209				
Test Method:	ANSI C63.10:2013				
Test Frequency Range:	30MHz to 25GHz				
Test site:	Measurement Distance: 3m				
Receiver setup:	Frequency	Detector	RBW	VBW	Remark
	30MHz-1GHz	Quasi-peak	120KHz	300KHz	Quasi-peak Value
	Above 1GHz	Peak	1MHz	3MHz	Peak Value
		Peak	1MHz	10Hz	Average Value
Limit:	Frequency		Limit (dBuV/m @3m)		Remark
	30MHz-88MHz		40.0		Quasi-peak Value
	88MHz-216MHz		43.5		Quasi-peak Value
	216MHz-960MHz		46.0		Quasi-peak Value
	960MHz-1GHz		54.0		Quasi-peak Value
	Above 1GHz		54.0		Average Value
74.0			Peak Value		
Test setup:	Below 1GHz				
Test setup:	Above 1GHz				

<p>Test Procedure:</p>	<ol style="list-style-type: none"> 1. The EUT was placed on the top of a rotating table (0.8 meters below 1G and 1.5 meters above 1G) above the ground at a 3 meter camber. The table was rotated 360 degrees to determine the position of the highest radiation. 2. The EUT was set 3 meters away from the interference-receiving antenna, which was mounted on the top of a variable-height antenna tower. 3. The antenna height is varied from one meter to four meters above the ground to determine the maximum value of the field strength. Both horizontal and vertical polarizations of the antenna are set to make the measurement. 4. For each suspected emission, the EUT was arranged to its worst case and then the antenna was tuned to heights from 1 meter to 4 meters and the rota table was turned from 0 degrees to 360 degrees to find the maximum reading. 5. The test-receiver system was set to Peak Detect Function and Specified Bandwidth with Maximum Hold Mode. 6. If the emission level of the EUT in peak mode was 10dB lower than the limit specified, then testing could be stopped and the peak values of the EUT would be reported. Otherwise the emissions that did not have 10dB margin would be re-tested one by one using peak, quasi-peak or average method as specified and then reported in a data sheet.
<p>Test Instruments:</p>	<p>Refer to section 1.7 for details</p>
<p>Test mode:</p>	<p>Refer to section 1.2 for details</p>
<p>Test results:</p>	<p>Pass</p>

Remark:

1. During the test, pre-scan the GFSK, Pi/4QPSK, 8DPSK modulation, and found the GFSK modulation which it is worse case.
2. Pre-scan all kind of the place mode (X-axis, Y-axis, Z-axis), and found the Y-axis which it is worse case.

Measurement data: The result is a test of the left earbuds

Vertical:

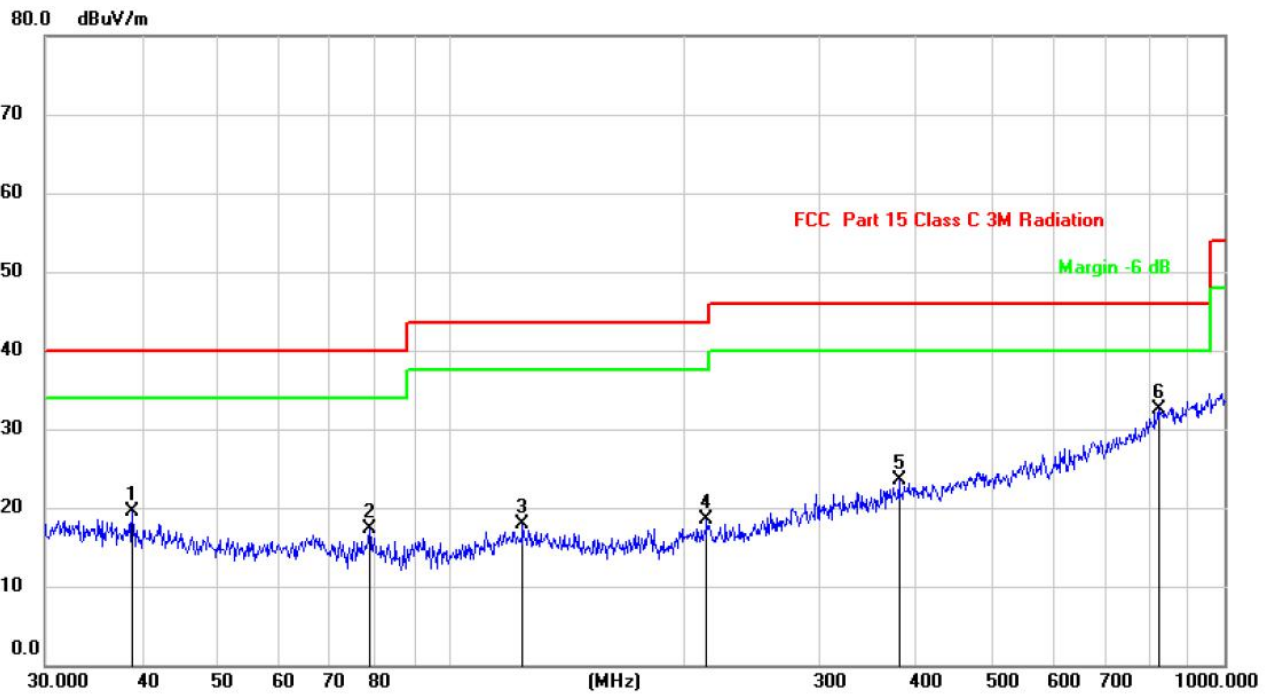

No.	Mk.	Freq.	Reading Level	Correct Factor	Measurement	Limit	Over	Antenna Height	Table Degree	
		MHz	dBuV	dBuV/m	dBuV/m	dBuV/m	dB	cm	degree	Comment
1		38.8878	14.82	4.63	19.45	40.00	-20.55	QP		
2		78.6888	16.14	1.23	17.37	40.00	-22.63	QP		
3		124.1329	13.99	3.91	17.90	43.50	-25.60	QP		
4		214.5142	14.83	3.64	18.47	43.50	-25.03	QP		
5		379.9141	13.84	9.65	23.49	46.00	-22.51	QP		
6	*	821.7103	14.58	17.83	32.41	46.00	-13.59	QP		

Horizontal:

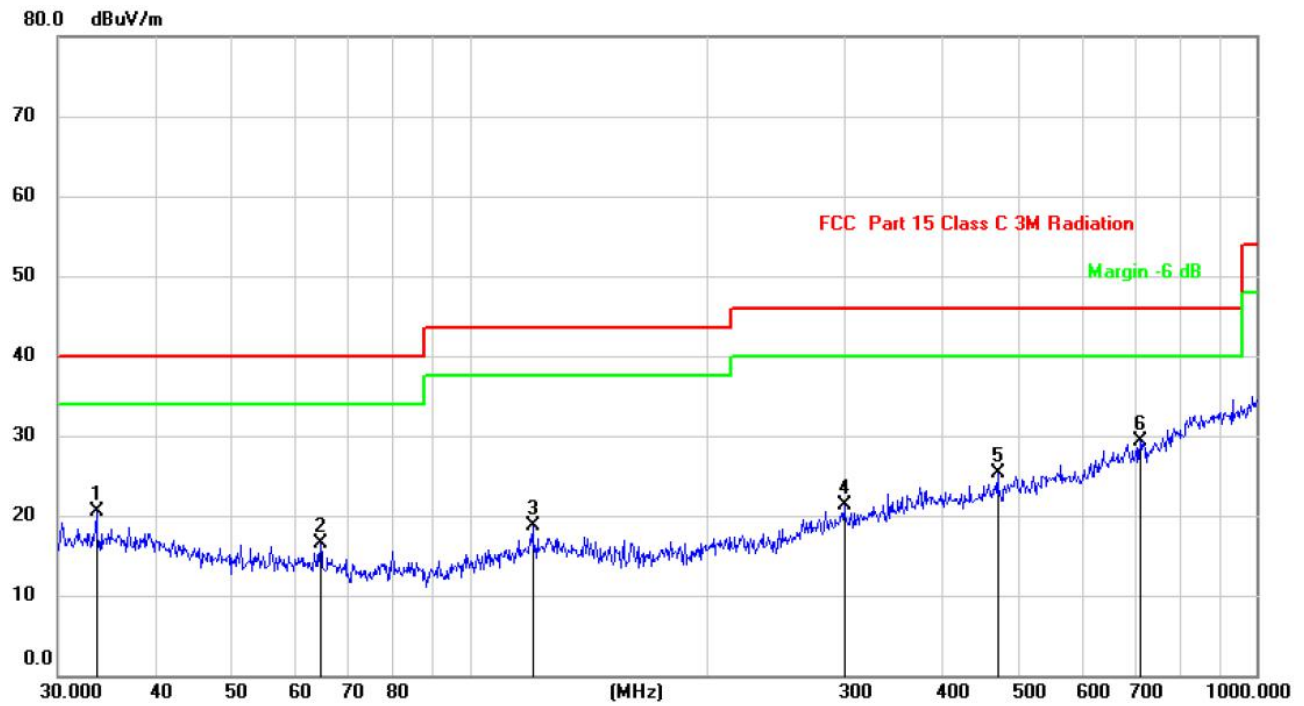

No.	Mk.	Freq.	Reading Level	Correct Factor	Measurement	Limit	Over	Antenna Height	Table Degree	
		MHz	dBuV	dBuV/m	dBuV/m	dBuV/m	dB	cm	degree	Comment
1		33.5623	15.64	4.88	20.52	40.00	-19.48	QP		
2		64.6594	15.09	1.35	16.44	40.00	-23.56	QP		
3		120.2766	14.57	4.13	18.70	43.50	-24.80	QP		
4		299.3158	14.35	7.04	21.39	46.00	-24.61	QP		
5		468.8761	14.82	10.46	25.28	46.00	-20.72	QP		
6	*	711.6734	15.41	13.88	29.29	46.00	-16.71	QP		

■ Above 1GHz

Test channel:	Lowest
---------------	--------

Peak value:

Frequency (MHz)	Level (dBuV/m)	Limit Line (dBuV/m)	Over Limit (dB)	Polarization
4804.00	45.26	74.00	-28.74	Vertical
7206.00	46.27	74.00	-27.73	Vertical
9608.00	49.33	74.00	-24.67	Vertical
12010.00		74.00		Vertical
14412.00		74.00		Vertical
4804.00	47.68	74.00	-26.32	Horizontal
7206.00	48.25	74.00	-25.75	Horizontal
9608.00	47.14	74.00	-26.86	Horizontal
12010.00		74.00		Horizontal
14412.00		74.00		Horizontal

Average value:

Frequency (MHz)	Level (dBuV/m)	Limit Line (dBuV/m)	Over Limit (dB)	Polarization
4804.00	35.27	54.00	-18.73	Vertical
7206.00	35.11	54.00	-18.89	Vertical
9608.00	37.48	54.00	-16.52	Vertical
12010.00		54.00		Vertical
14412.00		54.00		Vertical
4804.00	36.36	54.00	-17.64	Horizontal
7206.00	37.13	54.00	-16.87	Horizontal
9608.00	37.38	54.00	-16.62	Horizontal
12010.00		54.00		Horizontal
14412.00		54.00		Horizontal

Remark:

1. Final Level = Receiver Read level + Antenna Factor + Cable Loss – Pre-amplifier Factor
2. “*”, means this data is the too weak instrument of signal is unable to test.
3. The emission levels of other frequencies are very lower than the limit and not show in test report.

Test channel:	Middle
---------------	--------

Peak value:

Frequency (MHz)	Level (dBuV/m)	Limit Line (dBuV/m)	Over Limit (dB)	Polarization
4882.00	45.25	74.00	-28.75	Vertical
7323.00	46.49	74.00	-27.51	Vertical
9764.00	48.53	74.00	-25.47	Vertical
12205.00		74.00		Vertical
14646.00		74.00		Vertical
4882.00	46.37	74.00	-27.63	Horizontal
7323.00	48.91	74.00	-25.09	Horizontal
9764.00	47.43	74.00	-26.57	Horizontal
12205.00		74.00		Horizontal
14646.00		74.00		Horizontal

Average value:

Frequency (MHz)	Level (dBuV/m)	Limit Line (dBuV/m)	Over Limit (dB)	Polarization
4882.00	34.56	54.00	-19.44	Vertical
7323.00	35.79	54.00	-18.21	Vertical
9764.00	37.48	54.00	-16.52	Vertical
12205.00		54.00		Vertical
14646.00		54.00		Vertical
4882.00	36.61	54.00	-17.39	Horizontal
7323.00	35.47	54.00	-18.53	Horizontal
9764.00	37.44	54.00	-16.56	Horizontal
12205.00		54.00		Horizontal
14646.00		54.00		Horizontal

Remark:

1. *Final Level = Receiver Read level + Antenna Factor + Cable Loss – Pre-amplifier Factor*
2. *“*”*, means this data is the too weak instrument of signal is unable to test.
3. *The emission levels of other frequencies are very lower than the limit and not show in test report.*

Test channel:	Highest
---------------	---------

Peak value:

Frequency (MHz)	Level (dBUV/m)	Limit Line (dBUV/m)	Over Limit (dB)	Polarization
4960.00	45.23	74.00	-28.77	Vertical
7440.00	46.71	74.00	-27.29	Vertical
9920.00	48.82	74.00	-25.18	Vertical
12400.00		74.00		Vertical
14880.00		74.00		Vertical
4960.00	47.42	74.00	-26.58	Horizontal
7440.00	48.65	74.00	-25.35	Horizontal
9920.00	49.36	74.00	-24.64	Horizontal
12400.00		74.00		Horizontal
14880.00		74.00		Horizontal

Average value:

Frequency (MHz)	Level (dBUV/m)	Limit Line (dBUV/m)	Over Limit (dB)	Polarization
4960.00	34.27	54.00	-19.73	Vertical
7440.00	35.41	54.00	-18.59	Vertical
9920.00	38.72	54.00	-15.28	Vertical
12400.00		54.00		Vertical
14880.00		54.00		Vertical
4960.00	36.62	54.00	-17.38	Horizontal
7440.00	37.43	54.00	-16.57	Horizontal
9920.00	38.53	54.00	-15.47	Horizontal
12400.00		54.00		Horizontal
14880.00		54.00		Horizontal

Remark:

1. *Final Level = Receiver Read level + Antenna Factor + Cable Loss – Pre-amplifier Factor*
2. *“**”, means this data is the too weak instrument of signal is unable to test.*
3. *The emission levels of other frequencies are very lower than the limit and not show in test report.*

15. Test Setup Photo

Radiated Emission

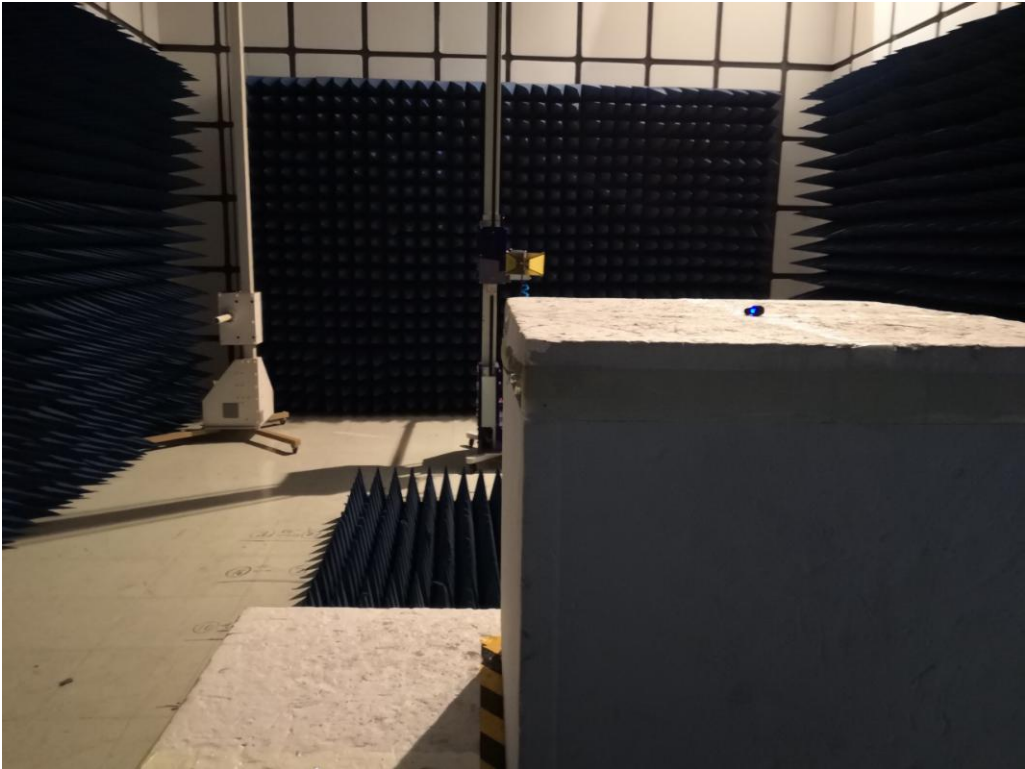
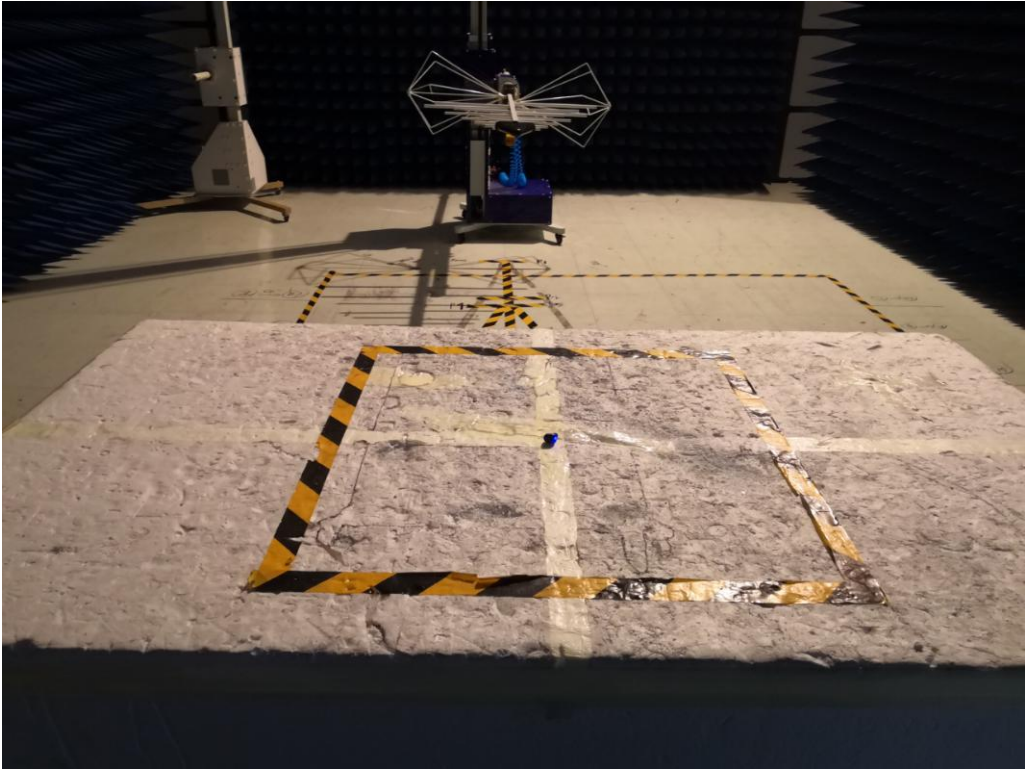

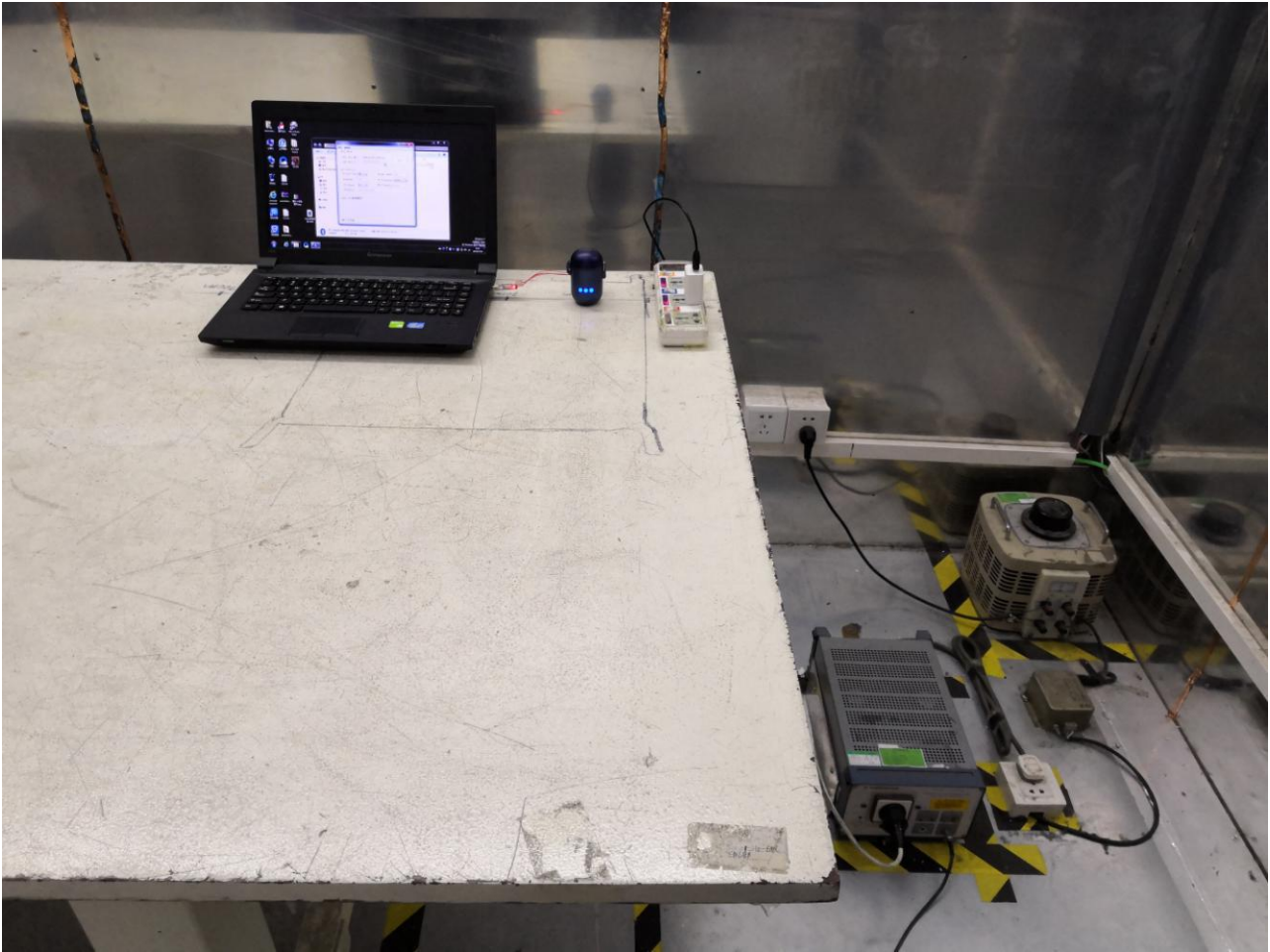

16. EUT Constructional Details

Please refer to report BSL18111980101RF.

-----End-----