



RF TEST REPORT

Applicant Quectel Wireless Solutions Co., Ltd
FCC ID XMR201807EG91NA
Product LTE Module
Brand Quectel
Model EG91-NA
Report No. R1805A0250-R1
Issue Date July 12, 2018

TA Technology (Shanghai) Co., Ltd. tested the above equipment in accordance with the requirements in **FCC CFR47 Part 2 (2017)/ FCC CFR 47 Part 22H (2017)**. The test results show that the equipment tested is capable of demonstrating compliance with the requirements as documented in this report.

Performed by: Jiangpeng Lan

Approved by: Kai Xu

TA Technology (Shanghai) Co., Ltd.

No.145, Jintang Rd, Tangzhen Industry Park, Pudong Shanghai, China

TEL: +86-021-50791141/2/3

FAX: +86-021-50791141/2/3-8000



TABLE OF CONTENT

1. Test Laboratory	4
1.1. Notes of the Test Report	4
1.2. Test facility	4
1.3. Testing Location	5
2. General Description of Equipment under Test.....	6
3. Applied Standards.....	7
4. Test Configuration.....	8
5. Test Case Results.....	10
5.1. RF Power Output.....	10
5.2. Effective Radiated Power	14
5.3. Occupied Bandwidth	17
5.4. Band Edge Compliance.....	24
5.5. Peak-to-Average Power Ratio (PAPR)	30
5.6. Frequency Stability	32
5.7. Spurious Emissions at Antenna Terminals	36
5.8. Radiates Spurious Emission	42
6. Main Test Instruments	50
ANNEX A: EUT Appearance and Test Setup.....	51
A.1 EUT Appearance	51
A.2 Test Setup.....	53

Summary of measurement results

No.	Test Type	Clause in FCC rules	Verdict
1	RF power output	2.1046	PASS
2	Effective Radiated Power	22.913(a)(5)	PASS
3	Occupied Bandwidth	2.1049	PASS
4	Band Edge Compliance	2.1051 / 22.917(a)	PASS
5	Peak-to-Average Power Ratio	22.913(d)/ KDB 971168 D01(5.7)	PASS
6	Frequency Stability	2.1055 / 22.355	PASS
7	Spurious Emissions at Antenna Terminals	2.1051 / 22.917(a)	PASS
8	Radiates Spurious Emission	2.1053 / 22.917 (a)	PASS
Date of Testing: May 25, 2018 ~ June 27, 2018			
Note: PASS: The EUT complies with the essential requirements in the standard. FAIL: The EUT does not comply with the essential requirements in the standard.			



1. Test Laboratory

1.1. Notes of the Test Report

This report shall not be reproduced in full or partial, without the written approval of **TA technology (shanghai) co., Ltd.** The results documented in this report apply only to the tested sample, under the conditions and modes of operation as described herein .Measurement Uncertainties were not taken into account and are published for informational purposes only. This report is written to support regulatory compliance of the applicable standards stated above.

1.2. Test facility

CNAS (accreditation number: L2264)

TA Technology (Shanghai) Co., Ltd. has obtained the accreditation of China National Accreditation Service for Conformity Assessment (CNAS).

FCC (Designation number: CN1179, Test Firm Registration Number: 446626)

TA Technology (Shanghai) Co., Ltd. has been listed on the US Federal Communications Commission list of test facilities recognized to perform electromagnetic emissions measurements.

IC (recognition number is 8510A)

TA Technology (Shanghai) Co., Ltd. has been listed by industry Canada to perform electromagnetic emission measurement.

VCCI (recognition number is C-4595, T-2154, R-4113, G-10766)

TA Technology (Shanghai) Co., Ltd. has been listed by industry Japan to perform electromagnetic emission measurement.

A2LA (Certificate Number: 3857.01)

TA Technology (Shanghai) Co., Ltd. has been listed by American Association for Laboratory Accreditation to perform electromagnetic emission measurement.



1.3. Testing Location

Company: TA Technology (Shanghai) Co., Ltd.
Address: No.145, Jintang Rd, Tangzhen Industry Park, Pudong
City: Shanghai
Post code: 201201
Country: P. R. China
Contact: Xu Kai
Telephone: +86-021-50791141/2/3
Fax: +86-021-50791141/2/3-8000
Website: <http://www.ta-shanghai.com>
E-mail: xukai@ta-shanghai.com



2. General Description of Equipment under Test

Client Information

Applicant	Quectel Wireless Solutions Co., Ltd
Applicant address	7th Floor, Hongye Building, No.1801 Hongmei Road, Xuhui District, Shanghai 200233, China
Manufacturer	Quectel Wireless Solutions Co., Ltd
Manufacturer address	7th Floor, Hongye Building, No.1801 Hongmei Road, Xuhui District, Shanghai 200233, China

General Information

EUT Description			
Model	EG91-NA		
IMEI	862831030088426		
Hardware Version	R1.0		
Software Version	EG91NAFBR05A03M4G		
Power Supply	External Power Supply		
Antenna Type	The EUT don't have standard Antenna, The Antenna used for testing in this report is the after-market accessory (Dipole Antenna)		
Test Mode(s)	WCDMA Band V;LTE Band 5;		
Test Modulation	(WCDMA)QPSK; (LTE)QPSK 16QAM;		
HSDPA UE Category	24		
HSUPA UE Category	6		
DC-HSDPA UE Category	24		
LTE Category	1		
Maximum E.R.P.	WCDMA Band V:	21.81dBm	
	LTE Band 5:	22.07dBm	
Rated Power Supply Voltage	3.8V		
Extreme Voltage	Minimum: 3.3V Maximum: 4.3V		
Extreme Temperature	Lowest: -40°C Highest: +85°C		
Operating Frequency Range(s)	Band	Tx (MHz)	Rx (MHz)
	WCDMA Band V	824 ~ 849	869 ~ 894
	LTE Band 5	824 ~ 849	869 ~ 894
Note: 1. The information of the EUT is declared by the manufacturer. 2. For LTE, 16QAM only supports 25%RB.			



3. Applied Standards

According to the specifications of the manufacturer, it must comply with the requirements of the following standards:

FCC CFR47 Part 2 (2017)

FCC CFR 47 Part 22H (2017)

ANSI/TIA-603-E (2016)

KDB 971168 D01 Power Meas License Digital Systems v03r01

4. Test Configuration

Radiated measurements are performed by rotating the EUT in three different orthogonal test planes. EUT stand-up position (Z axis), lie-down position (X, Y axis). Receiver antenna polarization (horizontal and vertical), the worst emission was found in position (Z axis, horizontal polarization) and the worst case was recorded.

All mode and data rates and positions were investigated. Subsequently, only the worst case emissions are reported.

The following testing in WCDMA/LTE is set based on the maximum RF Output Power.

Test modes are chosen to be reported as the worst case configuration below:

	Test items	Modes/Modulation
		WCDMA Band V
Conducted Test cases	RF power output	RMC HSDPA/HSUPA DC-HSDPA
	Occupied Bandwidth	RMC
	Band Edge Compliance	RMC
	Peak-to-Average Power Ratio	RMC
	Frequency Stability	RMC
	Spurious Emissions at Antenna Terminals	RMC
Radiated Test cases	Effective Radiated Power	RMC
	Radiates Spurious Emission	RMC



Test modes are chosen as the worst case configuration below for LTE Band 5.

Test items	Bandwidth (MHz)				Modulation		RB			Test Channel		
	1.4	3	5	10	QPSK	16QAM	1	50%	100%	L	M	H
RF power output	○	○	○	○	○	○	○	○	○	○	○	○
Effective Isotropic Radiated power	○	○	○	○	○	○	○	○	○	○	○	○
Occupied Bandwidth	○	○	○	○	○	○	○	-	○	○	○	○
Band Edge Compliance	○	○	○	○	○	○	○	-	○	○	-	○
Peak-to-Average Power Ratio	○	○	○	○	○	○	○	-	○	○	○	○
Frequency Stability	○	○	○	○	○	○	○	-	○	○	-	○
Spurious Emissions at Antenna Terminals	○	○	○	○	○	-	○	-	-	○	○	○
Radiates Spurious Emission	○	-	○	○	○	-	○	-	-	○	○	○
Note	1. The mark "○" means that this configuration is chosen for testing. 2. The mark "-" means that this configuration is not testing. 3. For LTE, 16QAM only supports 25%RB.											

5. Test Case Results

5.1. RF Power Output

Ambient condition

Temperature	Relative humidity	Pressure
23°C ~25°C	45%~50%	101.5kPa

Methods of Measurement

During the process of the testing, The EUT is controlled by the Base Station Simulator to ensure max power transmission and proper modulation.

Test Setup

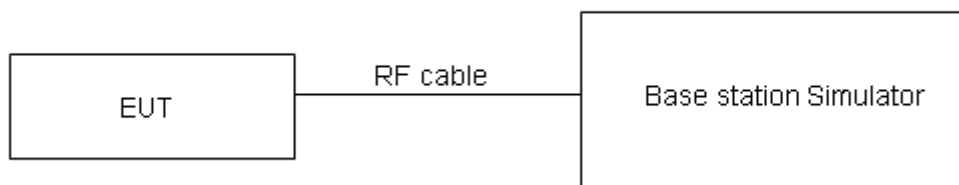

The loss between RF output port of the EUT and the input port of the tester has been taken into consideration.

Limits

No specific RF power output requirements in part 2.1046.

Measurement Uncertainty

The assessed measurement uncertainty to ensure 95% confidence level for the normal distribution is with the coverage factor $k = 2$, $U = 0.4$ dB.

Test Results

WCDMA Band V		Conducted Power(dBm)		
		Channel 4132	Channel 4183	Channel 4233
		826.4(MHz)	836.6(MHz)	846.6(MHz)
RMC	12.2k	23.06	22.99	23.12
	64k	22.99	22.85	23.06
	144k	22.98	22.84	22.96
	384k	22.97	22.83	22.95
HSDPA	Sub - Test 1	22.79	22.64	22.69
	Sub - Test 2	22.75	22.68	22.78
	Sub - Test 3	22.39	22.32	22.30
	Sub - Test 4	22.31	22.25	22.26
HSUPA	Sub - Test 1	22.82	22.74	22.75
	Sub - Test 2	22.31	22.26	22.29
	Sub - Test 3	22.76	22.78	22.75
	Sub - Test 4	22.77	22.71	22.76
	Sub - Test 5	22.73	22.76	22.71
DC-HSDPA	Sub - Test 1	22.93	22.86	22.99
	Sub - Test 2	23.02	22.84	22.98
	Sub - Test 3	22.51	22.33	22.47
	Sub - Test 4	22.50	22.32	22.46

LTE Band 5				Conducted Power(dBm)		
BW	Modulation	RB size	RB offset	Channel/Frequency(MHz)		
				20407/824.7	20525/836.5	20643/848.3
1.4MHz	QPSK	1	0	23.83	23.93	23.87
		1	2	23.97	24.02	24.23
		1	5	23.76	23.94	23.92
		3	0	23.83	23.77	24.04
		3	2	23.81	23.79	24.03
		3	3	23.87	23.84	23.98
	6	0	22.86	22.86	22.95	
	16QAM	1	0	23.44	22.82	22.85
		1	2	23.47	23.03	23.04
1		5	23.29	22.83	22.84	
BW	Modulation	RB size	RB offset	Channel/Frequency(MHz)		
				20415/825.5	20525/836.5	20635/847.5
3MHz	QPSK	1	0	23.95	24.06	23.83
		1	7	24.19	24.10	24.01
		1	14	23.79	23.77	23.96
		8	0	23.13	23.07	22.92
		8	4	22.92	23.01	22.96
		8	7	22.97	23.01	23.05
	15	0	23.09	23.07	23.04	
	16QAM	1	0	22.73	23.28	23.55
		1	7	23.04	23.61	24.09
1		14	22.82	23.21	23.53	
BW	Modulation	RB size	RB offset	Channel/Frequency(MHz)		
				20425/826.5	20525/836.5	20625/846.5
5MHz	QPSK	1	0	23.94	24.02	23.81
		1	13	24.17	24.09	23.98
		1	24	23.76	23.72	23.92
		12	0	23.11	23.03	22.89
		12	6	22.89	22.96	22.92
		12	13	22.94	22.98	23.01
	25	0	23.07	23.03	22.99	
	16QAM	1	0	22.68	23.26	23.53
		1	13	23.02	23.58	24.07



		1	24	22.79	23.17	23.50
BW	Modulation	RB size	RB offset	Channel/Frequency(MHz)		
				20450/829	20525/836.5	20600/844
10MHz	QPSK	1	0	23.91	23.98	23.78
		1	25	24.16	24.05	23.96
		1	49	23.74	23.71	23.89
		25	0	23.08	22.98	22.85
		25	13	22.87	22.92	22.89
		25	25	22.91	22.93	22.97
		50	0	23.04	22.98	22.95
	16QAM	1	0	22.66	23.22	23.48
		1	25	22.98	23.56	24.03
		1	49	22.77	23.14	23.48

5.2. Effective Radiated Power

Ambient condition

Temperature	Relative humidity	Pressure
23°C ~25°C	45%~50%	101.5kPa

Methods of Measurement

The testing follows FCC KDB 971168 v03r01 Section 5.8 and ANSI/TIA-603-E (2016).

- a) Connect the equipment as illustrated. Mount the equipment with the manufacturer specified antenna in a vertical orientation on a manufacturer specified mounting surface located on a non-conducting rotating platform of a RF anechoic chamber (preferred) or a standard radiation site.
- b) Key the transmitter, then rotate the EUT 360° azimuthally and record spectrum analyzer power level (LVL) measurements at angular increments that are sufficiently small to permit resolution of all peaks. If a standard radiation test site is used, raise and lower the test antenna to obtain a maximum reading at each angular increment. (Note: several batteries may be needed to offset the effect of battery voltage droop, which should not exceed 5% of the manufactured specified battery voltage during transmission).
- c) Replace the transmitter under test with a vertically polarized half-wave dipole (or an antenna whose gain is known relative to an ideal half-wave dipole). The center of the antenna should be at the same location as the center of the antenna under test.
- d) Connect the antenna to a signal generator with a known output power and record the path loss (in dB) as LOSS. If a standard radiation test site is used, raise and lower the test antenna to obtain a maximum reading. $LOSS = \text{Generator Output Power (dBm)} - \text{Analyzer reading (dBm)}$
- e) Determine the effective radiated output power at each angular position from the readings in steps b) and d) using the following equation: $ERP \text{ (dBm)} = LVL \text{ (dBm)} + LOSS \text{ (dB)}$
- f) The maximum ERP is the maximum value determined in the preceding step.
- g) When calculating ERP, in addition to knowing the antenna radiation and matching characteristics, it is necessary to know the loss values of all elements (e.g. transmission line attenuation, mismatches, filters, combiners) interposed between the point where transmitter output power is measured, and the point where power is applied to the antenna. ERP can then be calculated as follows:
 $ERP \text{ (dBm)} = \text{Output Power (dBm)} - \text{Losses (dB)} + \text{Antenna Gain (dBd)}$
 where: dBd refers to gain relative to an ideal dipole.
 $EIRP \text{ (dBm)} = ERP \text{ (dBm)} + 2.15 \text{ (dB.)}$

The RB allocation refers to section 5.1, using the maximum output power configuration.

Test setup

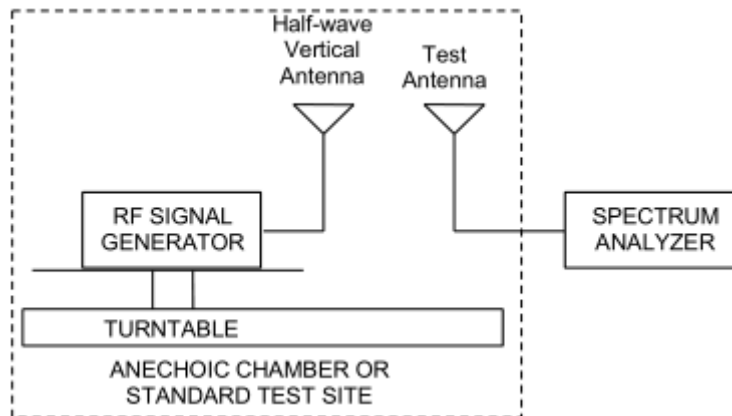
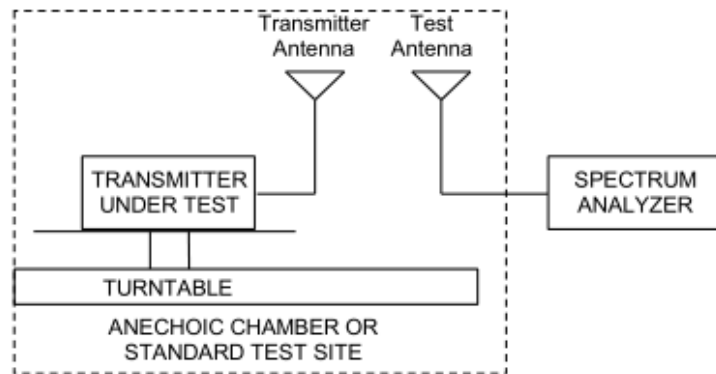

Limits

Rule Part 22.913(a)(5) specifies that "Mobile/portable stations are limited to 7 watts ERP".

Limit	$\leq 7 \text{ W}$ (38.45 dBm)
-------	--------------------------------

Measurement Uncertainty

The assessed measurement uncertainty to ensure 95% confidence level for the normal distribution is with the coverage factor $k = 2$, $U = 1.19 \text{ dB}$

Test Results:

The measurement is performed for both of horizontal and vertical antenna Polarization, and only the data of worst mode is recorded in this report.

Mode	Channel	Frequency (MHz)	Polarization	ERP (dBm)	Limit (dBm)	Conclusion
WCDMA Band V	Low	826.4	Horizontal	21.81	38.45	Pass
	Mid	836.6	Horizontal	21.69	38.45	Pass
	High	846.6	Horizontal	21.65	38.45	Pass

LTE Band 5						
bandwidth	Channel	Frequency (MHz)	Polarization	ERP (dBm)	Limit (dBm)	Conclusion
1.4 MHz (QPSK)	Low	824.7	Horizontal	21.73	38.45	Pass
	Mid	836.5	Horizontal	21.86	38.45	Pass
	High	848.3	Horizontal	20.95	38.45	Pass
3 MHz (QPSK)	Low	825.5	Horizontal	22.07	38.45	Pass
	Mid	836.5	Horizontal	21.86	38.45	Pass
	High	847.5	Horizontal	21.52	38.45	Pass
5 MHz (QPSK)	Low	826.5	Horizontal	21.76	38.45	Pass
	Mid	836.5	Horizontal	21.84	38.45	Pass
	High	846.5	Horizontal	20.97	38.45	Pass
10 MHz (QPSK)	Low	829	Horizontal	21.93	38.45	Pass
	Mid	836.5	Horizontal	21.46	38.45	Pass
	High	844	Horizontal	21.33	38.45	Pass
1.4 MHz (16QAM)	Low	824.7	Horizontal	21.32	38.45	Pass
	Mid	836.5	Horizontal	21.44	38.45	Pass
	High	848.3	Horizontal	21.51	38.45	Pass
3 MHz (16QAM)	Low	825.5	Horizontal	21.68	38.45	Pass
	Mid	836.5	Horizontal	21.59	38.45	Pass
	High	847.5	Horizontal	21.26	38.45	Pass
5 MHz (16QAM)	Low	826.5	Horizontal	21.34	38.45	Pass
	Mid	836.5	Horizontal	21.52	38.45	Pass
	High	846.5	Horizontal	20.82	38.45	Pass
10 MHz (16QAM)	Low	829	Horizontal	21.54	38.45	Pass
	Mid	836.5	Horizontal	21.13	38.45	Pass
	High	844	Horizontal	20.93	38.45	Pass

5.3. Occupied Bandwidth

Ambient condition

Temperature	Relative humidity	Pressure
23°C ~25°C	45%~50%	101.5kPa

Method of Measurement

The EUT was connected to Spectrum Analyzer and Base Station Simulator via power Splitter. The occupied bandwidth is measured using spectrum analyzer.

RBW is set to 51kHz, VBW is set to 160kHz for WCDMA Band V,

RBW is set to 51 kHz, VBW is set to 160 kHz for LTE Band 5(1.4MHz),

RBW is set to 100 kHz, VBW is set to 300 kHz for LTE Band 5 (3MHz/5MHz),

RBW is set to 300 kHz, VBW is set to 1 MHz for LTE Band 5 (10MHz),

99% power and -26dBc occupied bandwidths are recorded. Spectrum analyzer plots are included on the following pages.

Test Setup

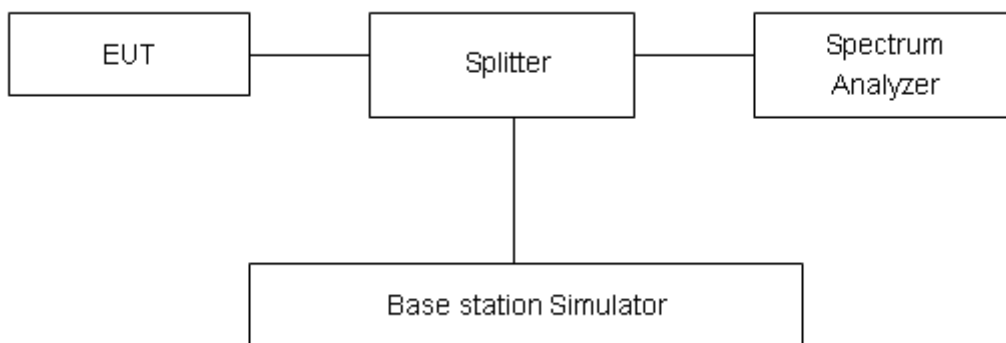

Limits

No specific occupied bandwidth requirements in part 2.1049.

Measurement Uncertainty

The assessed measurement uncertainty to ensure 95% confidence level for the normal distribution is with the coverage factor $k = 2$, $U = 624\text{Hz}$.



Test Result

Mode	Channel	Frequency (MHz)	99% Power Bandwidth (MHz)	-26dBc Bandwidth(MHz)
WCDMA Band V (RMC)	4132	826.4	4.1269	4.685
	4183	836.6	4.1183	4.685
	4233	846.6	4.1231	4.678

LTE Band 5						
RB	Modulation	Bandwidth (MHz)	Channel	Frequency (MHz)	99% Power Bandwidth(MHz)	-26dBc Bandwidth(MHz)
100%	QPSK	1.4	20407	824.7	1.1153	1.335
			20525	836.5	1.1105	1.318
			20643	848.3	1.1131	1.333
		3	20415	825.5	2.7631	3.027
			20525	836.5	2.7477	3.062
			20635	847.5	2.7387	3.030
		5	20425	826.5	4.5394	4.990
			20525	836.5	4.5060	4.983
			20625	846.5	4.5035	4.990
		10	20450	829	9.0220	10.000
			20525	836.5	9.0084	10.020
			20600	844	9.0109	10.080
	16QAM	1.4	20407	824.7	0.3261	0.4641
			20525	836.5	0.3211	0.4559
			20643	848.3	0.3141	0.4524
		3	20415	825.5	0.3980	0.5474
			20525	836.5	0.4022	0.5535
			20635	847.5	0.4075	0.5434
		5	20425	826.5	0.4914	0.6870
			20525	836.5	0.4822	0.6890
			20625	846.5	0.4648	0.6664
		10	20450	829	0.8771	1.2320
			20525	836.5	0.8657	1.1910
			20600	844	0.8614	1.1910

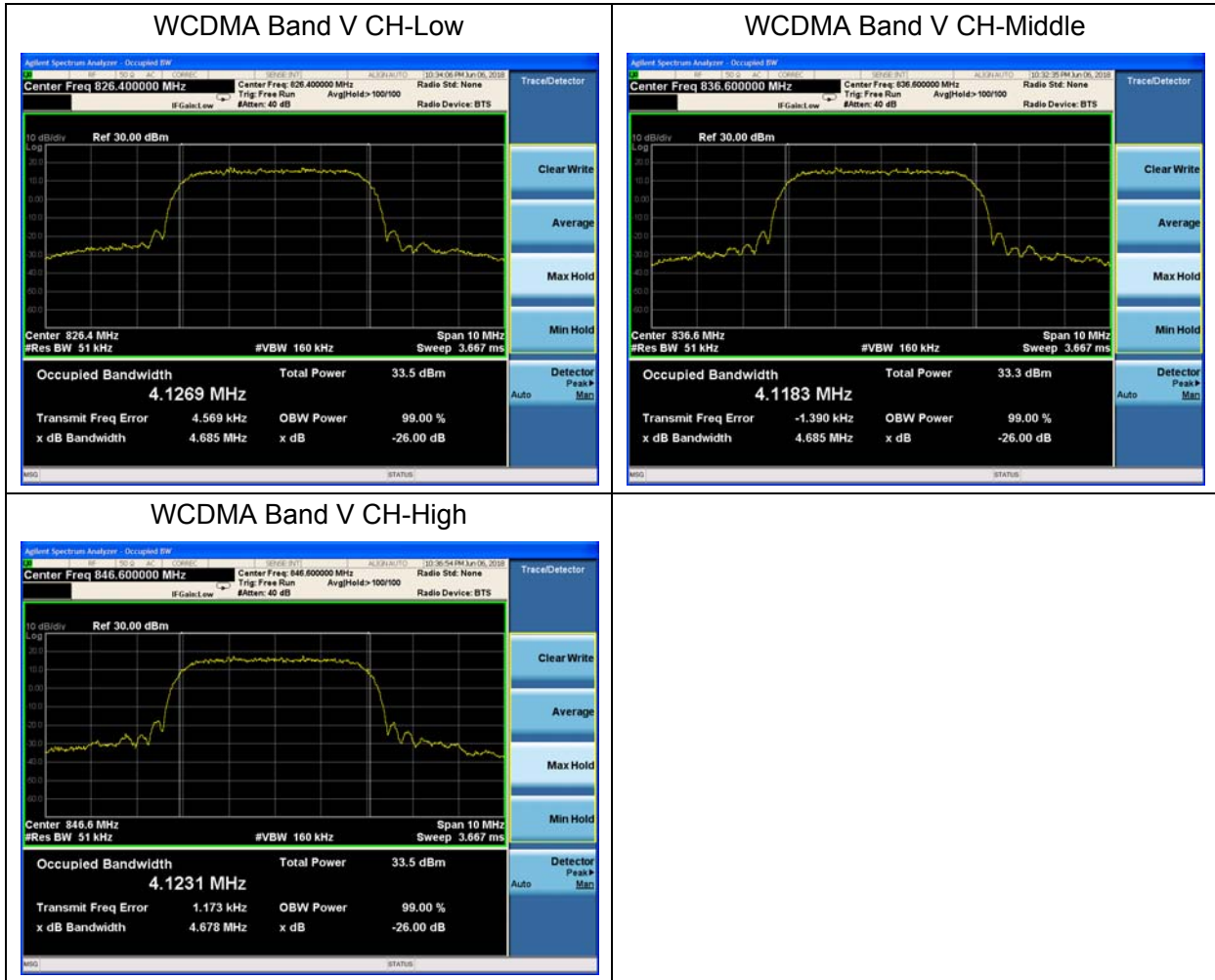

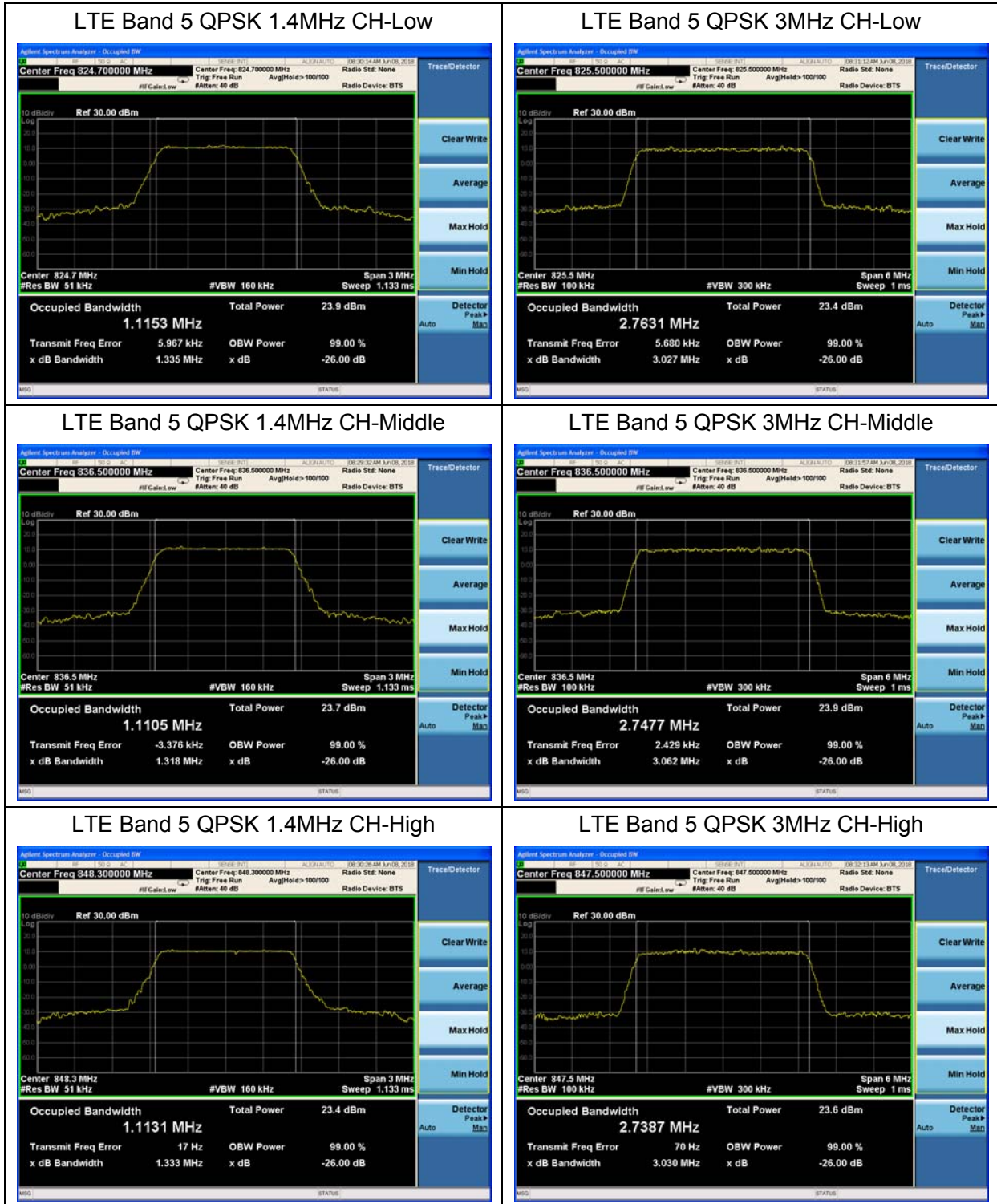

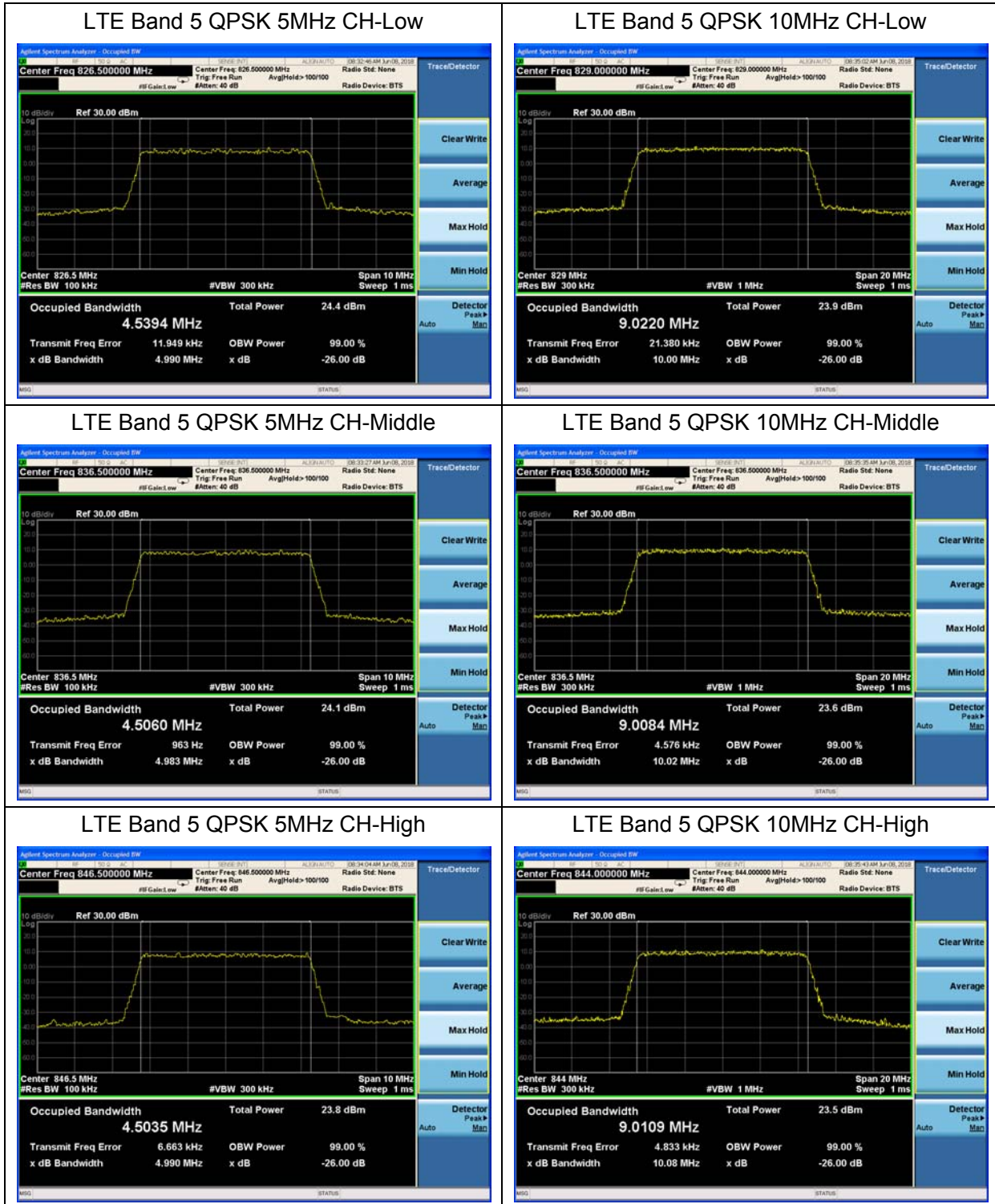

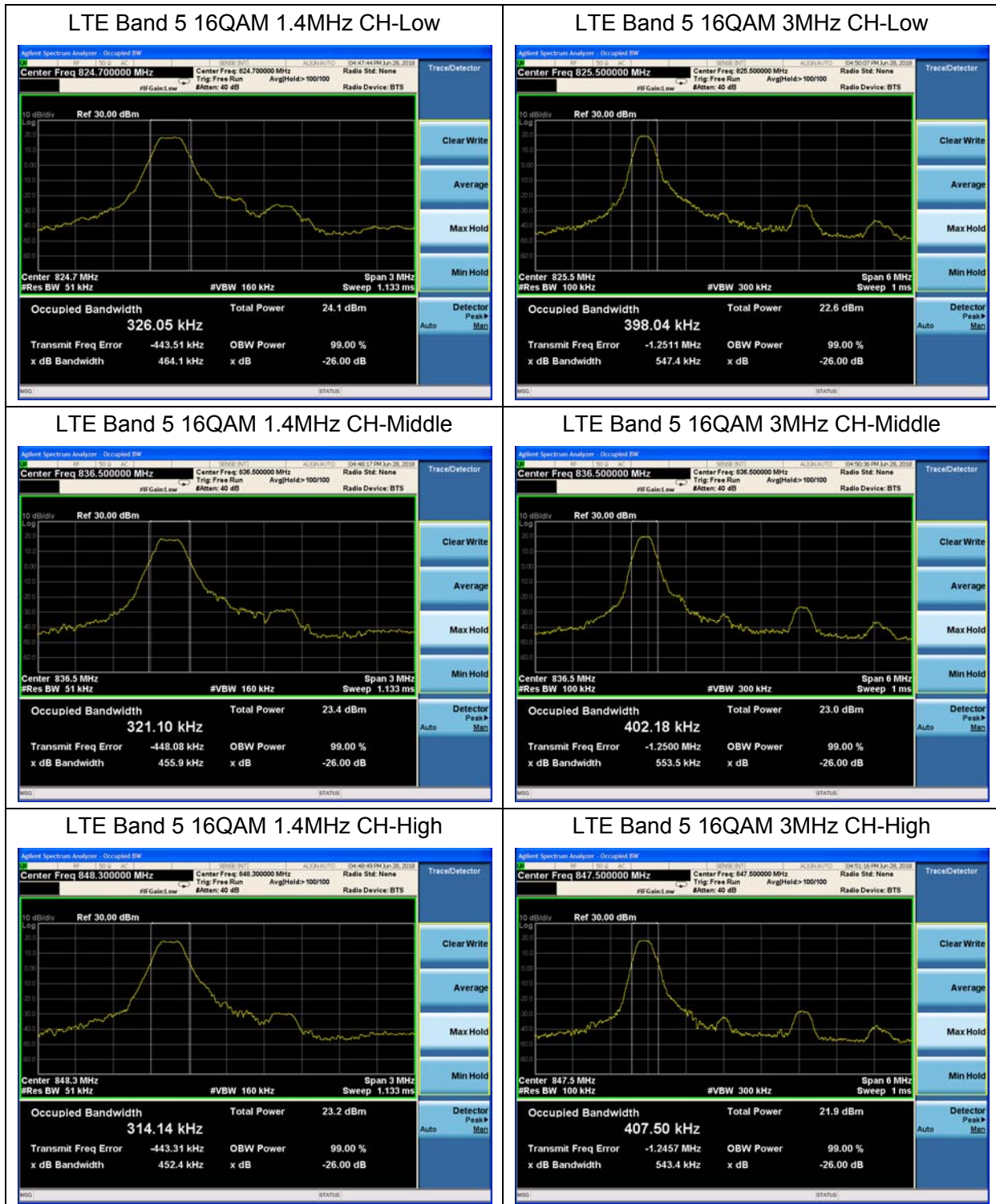

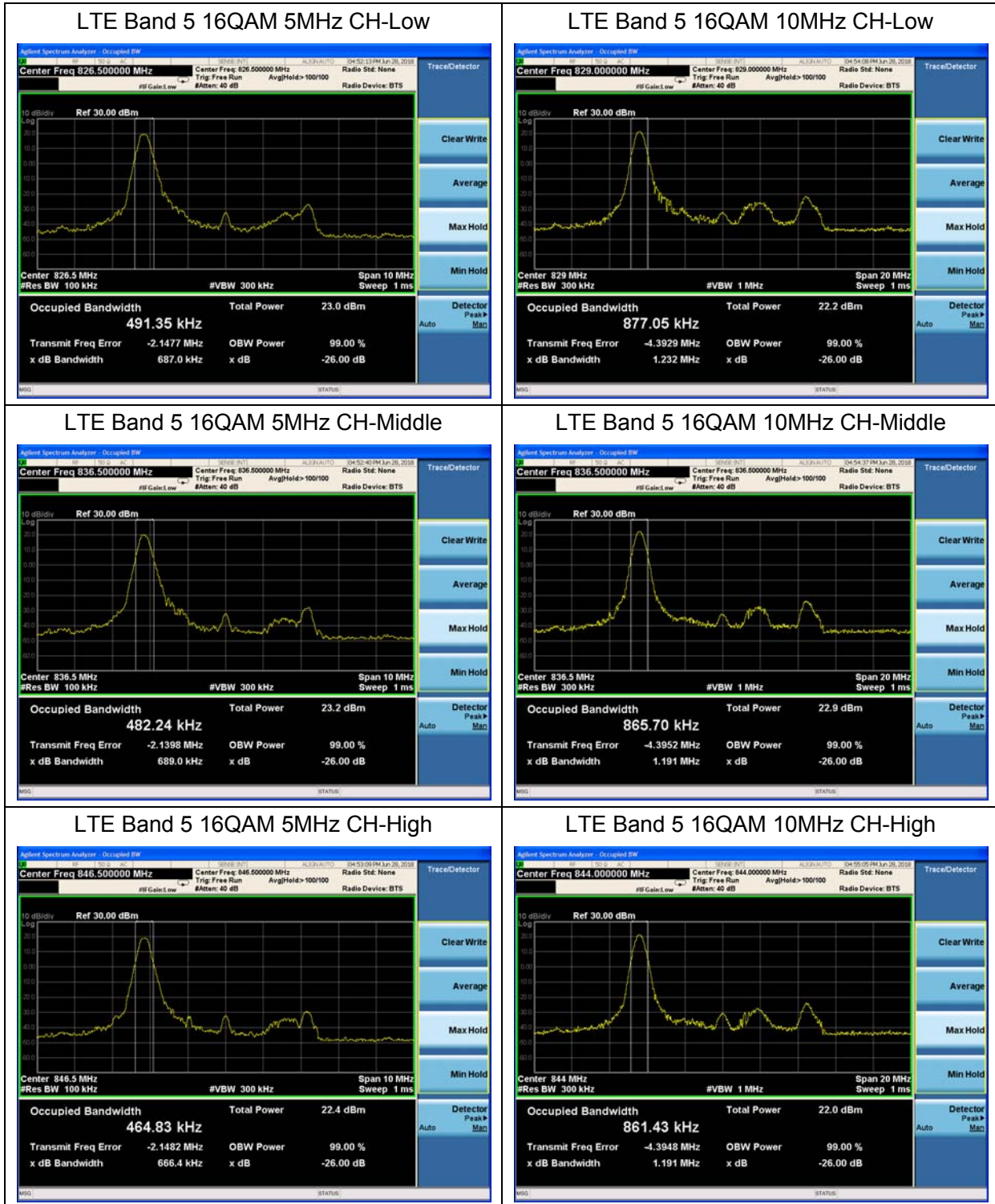

5.4. Band Edge Compliance

Ambient condition

Temperature	Relative humidity	Pressure
23°C ~25°C	45%~50%	101.5kPa

Method of Measurement

The EUT was connected to Spectrum Analyzer and Base Station Simulator via power Splitter. The band edge of the lowest and highest channels were measured. The average detector is used. RBW is set to 51kHz,VBW is set to 160kHz for WCDMA Band V, RBW is set to 15 kHz, VBW is set to 51 kHz for LTE Band 5(1.4MHz), RBW is set to 30 kHz, VBW is set to 100 kHz for LTE Band 5(3MHz), RBW is set to 51 kHz, VBW is set to 160 kHz for LTE Band 5(5MHz), RBW is set to 100 kHz, VBW is set to 300 kHz for LTE Band 5(10MHz),

Spectrum analyzer plots are included on the following pages.

Test Setup

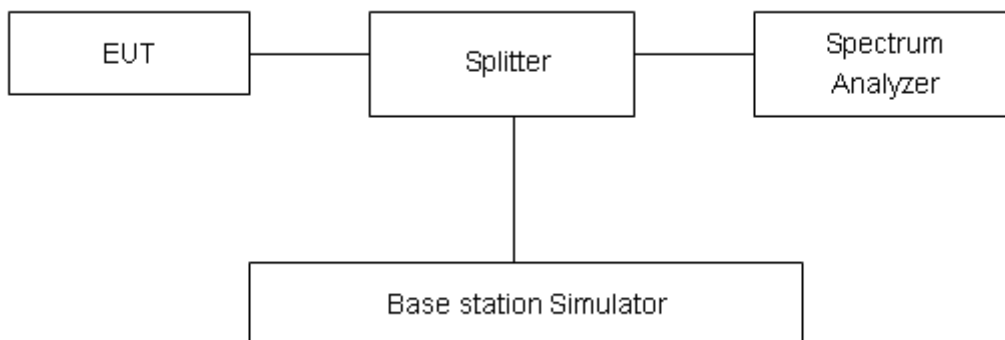

Limits

Rule Part 22.917(a) specifies that “The power of any emission outside of the authorized operating frequency ranges must be attenuated below the transmitting power (P) by a factor of at least 43 + 10 log(P) dB.”

Limit	-13 dBm
-------	---------

Measurement Uncertainty

The assessed measurement uncertainty to ensure 95% confidence level for the normal distribution is with the coverage factor $k = 1.96$, $U=0.684$ dB.



Test Result:

WCDMA Band V CH-Low



WCDMA Band V CH-High



LTE Band 5 QPSK 1.4MHz CH-Low 1RB

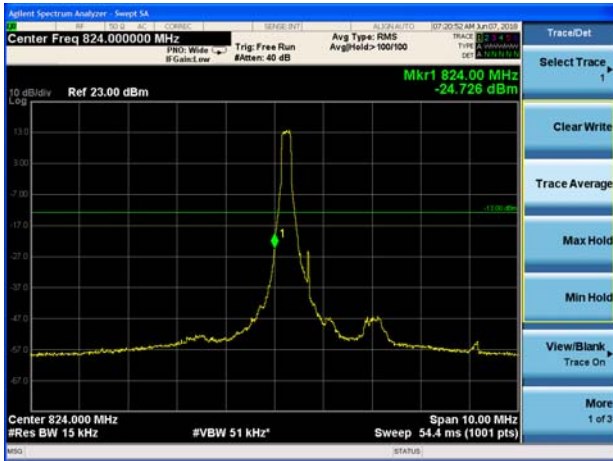

LTE Band 5 QPSK 1.4MHz CH-High 1RB

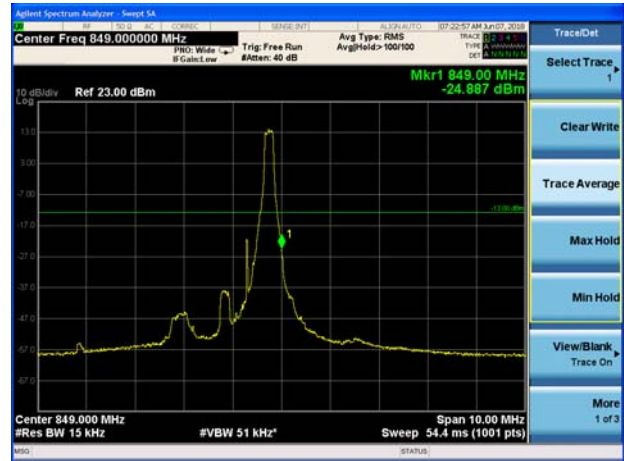

LTE Band 5 QPSK 1.4MHz CH-Low 100%RB

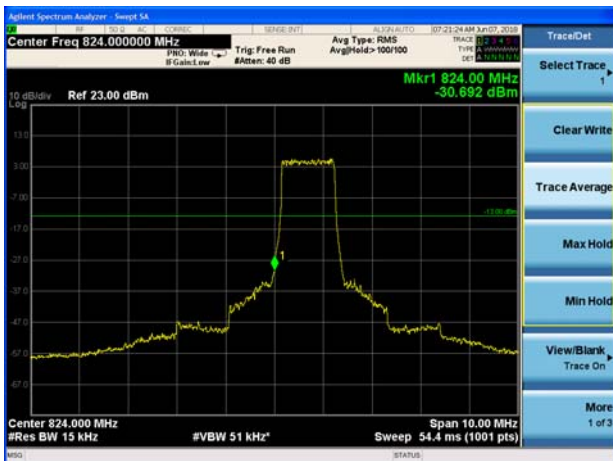

LTE Band 5 QPSK 1.4MHz CH-High 100%RB

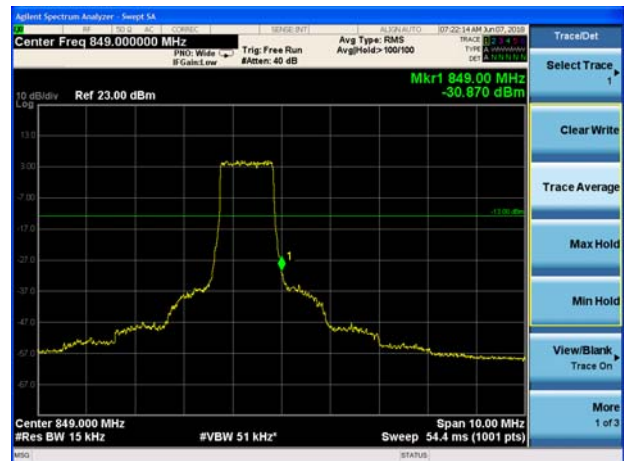



LTE Band 5 QPSK 3MHz CH-Low 1RB

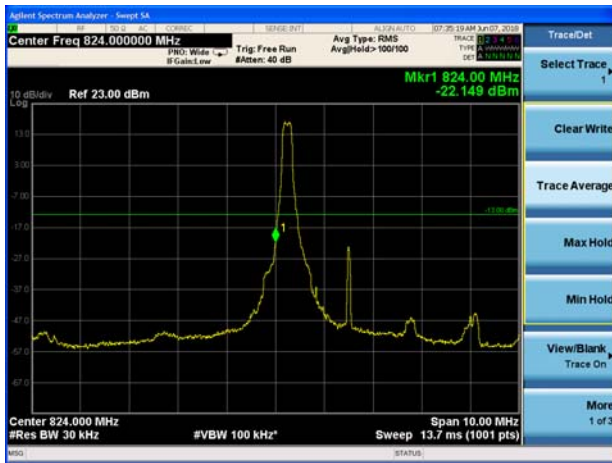

LTE Band 5 QPSK 3MHz CH-High 1RB

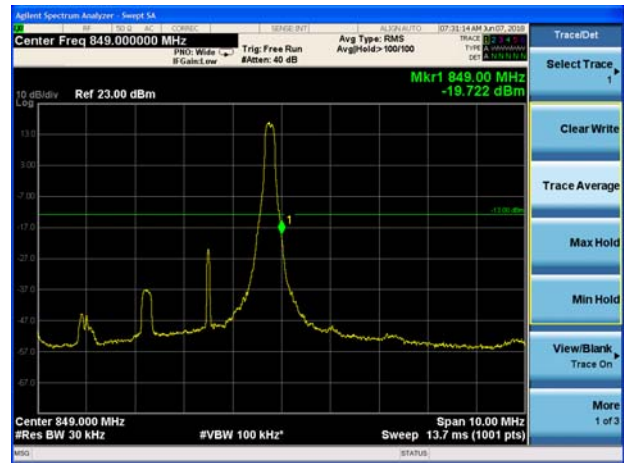

LTE Band 5 QPSK 3MHz CH-Low 100%RB

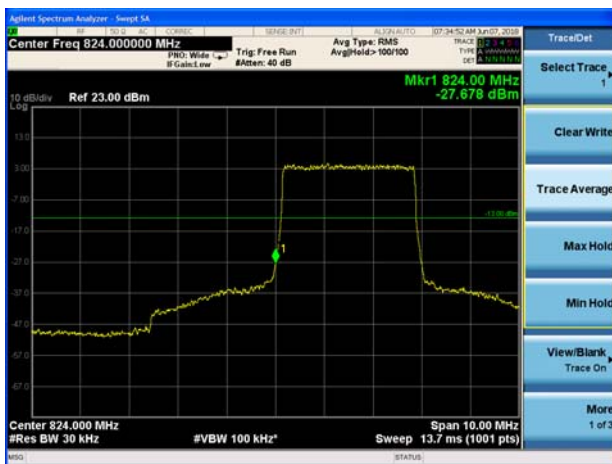

LTE Band 5 QPSK 3MHz CH-High 100%RB

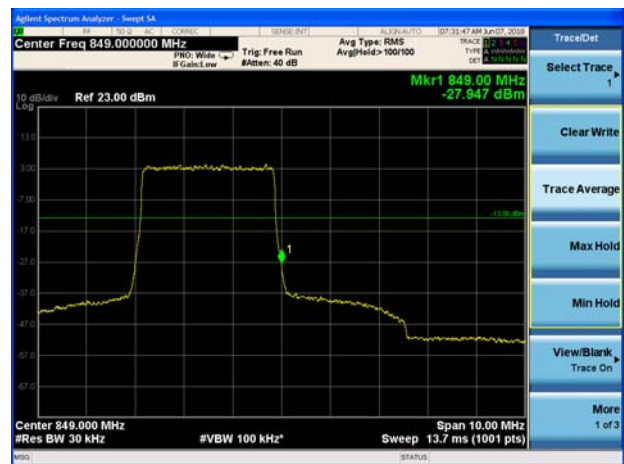

LTE Band 5 QPSK 5MHz CH-Low 1RB

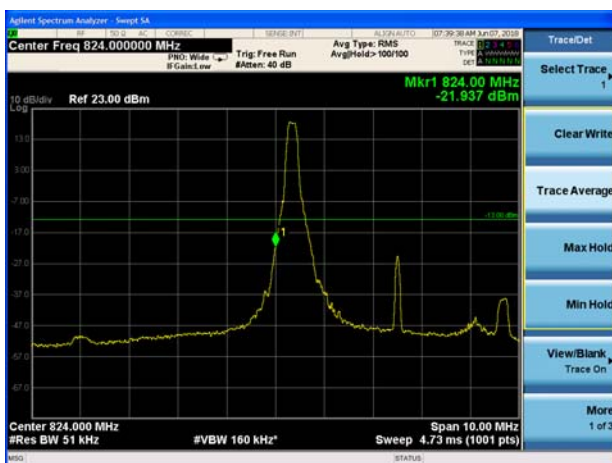

LTE Band 5 QPSK 5MHz CH-High 1RB

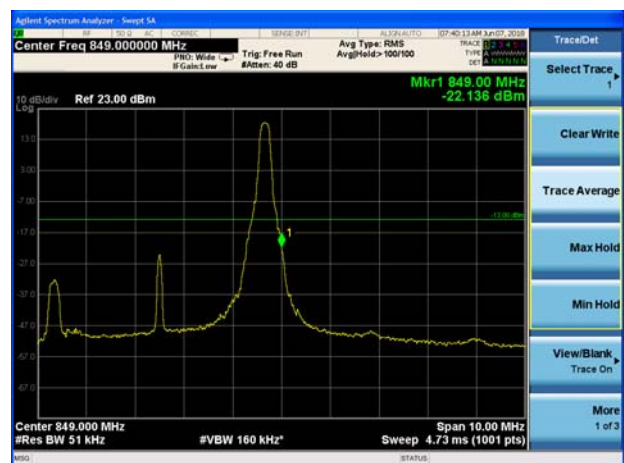



LTE Band 5 QPSK 5MHz CH-Low 100%RB

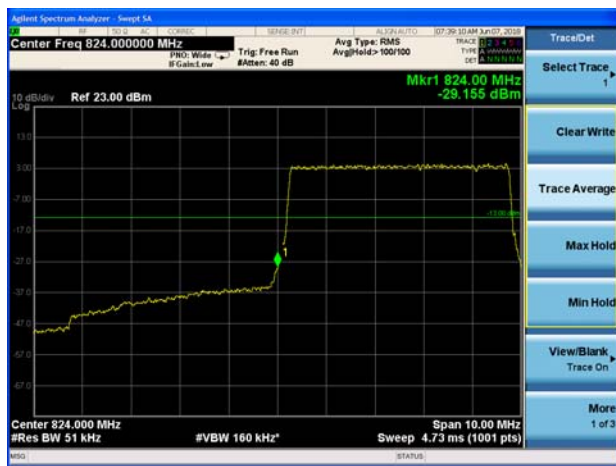

LTE Band 5 QPSK 5MHz CH-High 100%RB



LTE Band 5 QPSK 10MHz CH-Low 1RB

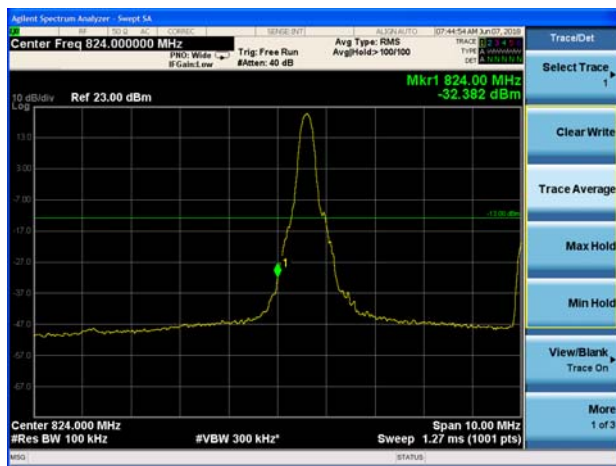

LTE Band 5 QPSK 10MHz CH-High 1RB

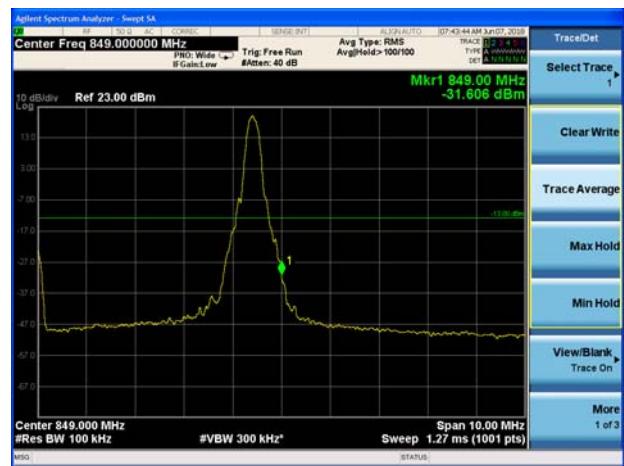

LTE Band 5 QPSK 10MHz CH-Low 100%RB

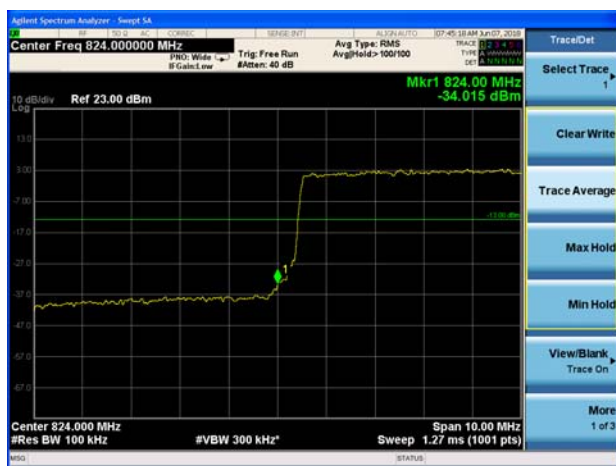

LTE Band 5 QPSK 10MHz CH-High 100%RB





LTE Band 5 16QAM 1.4MHz CH-Low 1RB

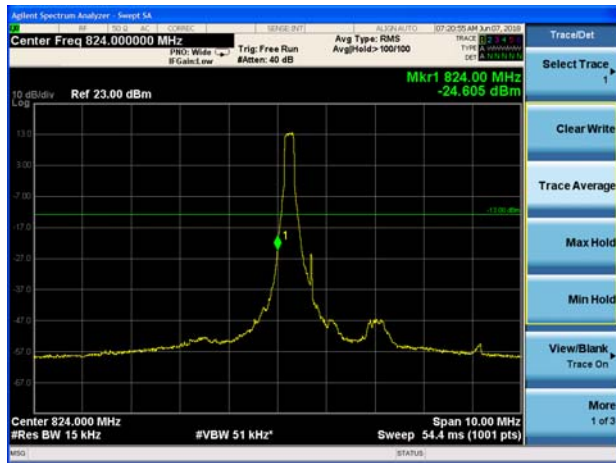

LTE Band 5 16QAM 1.4MHz CH-High 1RB

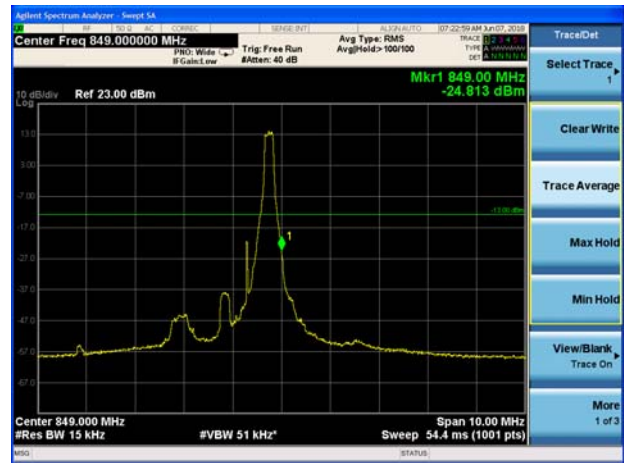

LTE Band 5 16QAM 3MHz CH-Low 1RB

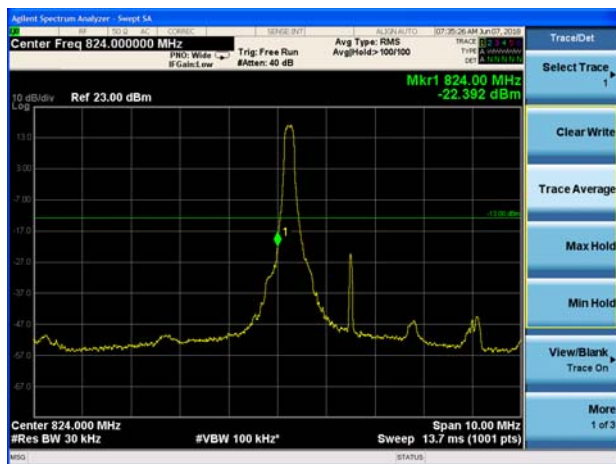

LTE Band 5 16QAM 3MHz CH-High 1RB

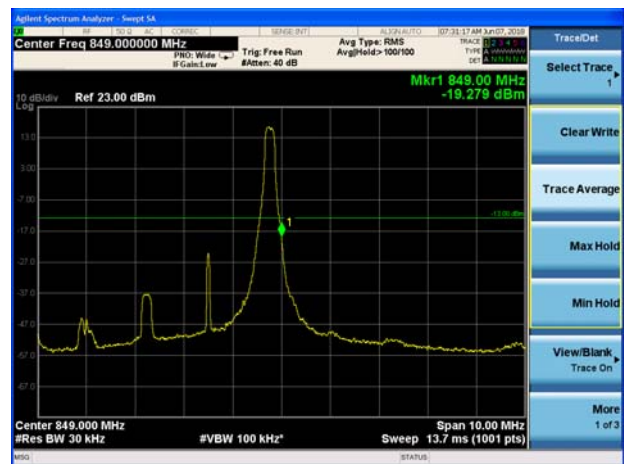

LTE Band 5 16QAM 5MHz CH-Low 1RB

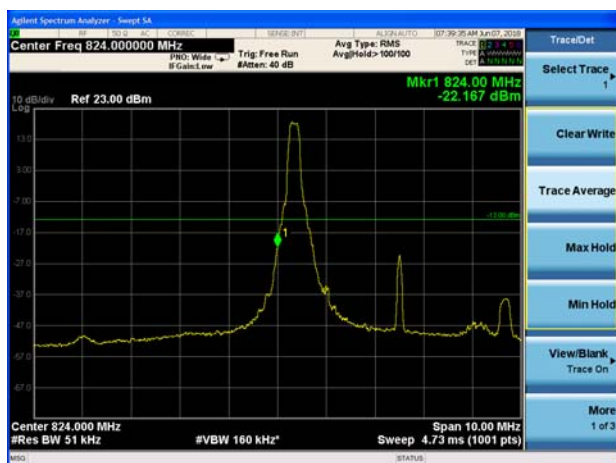

LTE Band 5 16QAM 5MHz CH-High 1RB

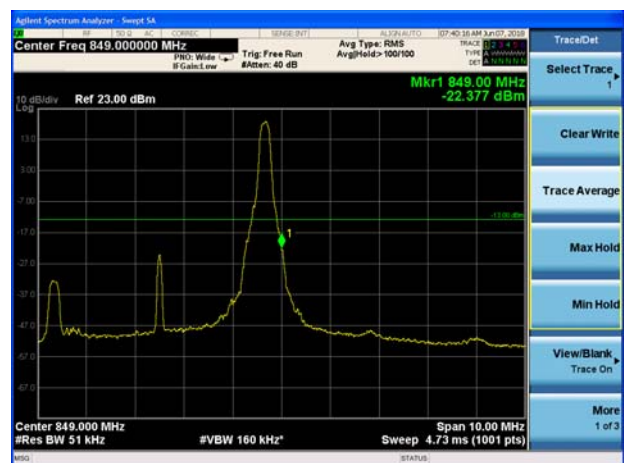



LTE Band 5 16QAM 10MHz CH-Low 1RB

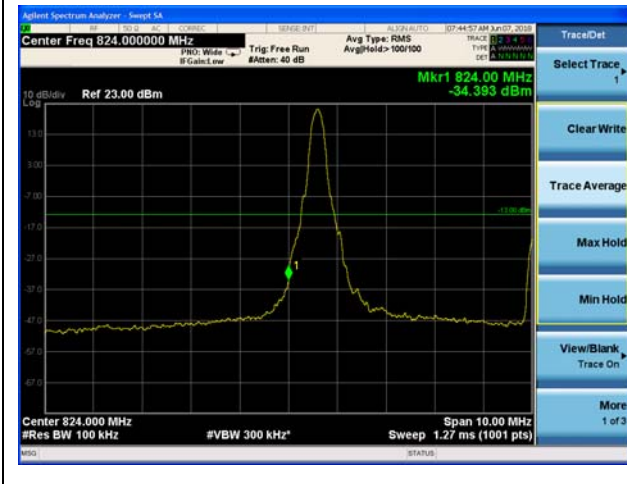

LTE Band 5 16QAM 10MHz CH-High 1RB

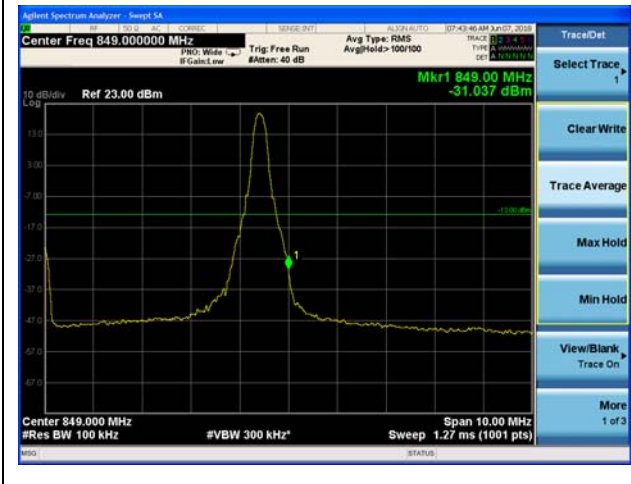

5.5. Peak-to-Average Power Ratio (PAPR)

Ambient condition

Temperature	Relative humidity	Pressure
23°C ~25°C	45%~50%	101.5kPa

Methods of Measurement

Measure the total peak power and record as P_{Pk} . And measure the total average power and record as P_{Avg} . Both the peak and average power levels must be expressed in the same logarithmic units (e.g., dBm). Determine the PAPR from:

$$PAPR (dB) = P_{Pk} (dBm) - P_{Avg} (dBm).$$

Test Setup

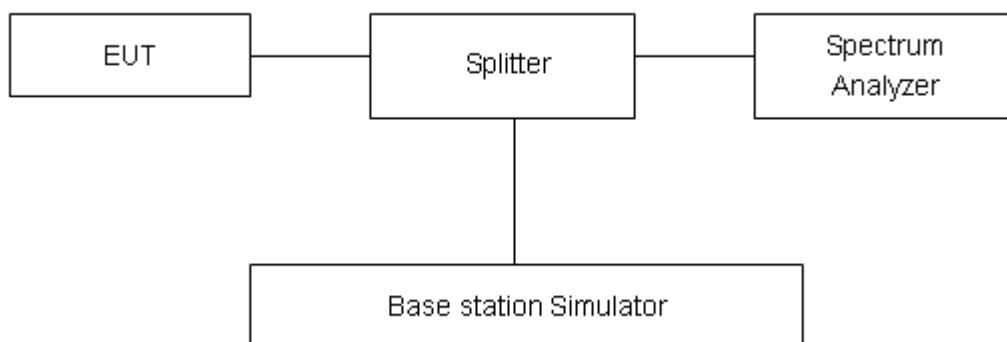

Limits

According to the Sec. 22.913(d), The peak-to-average ratio (PAR) of the transmission must not exceed 13 dB.

Measurement Uncertainty

The assessed measurement uncertainty to ensure 95% confidence level for the normal distribution is with the coverage factor $k = 2$, $U = 0.4$ dB.



Test Results

Mode	Channel	Frequency (MHz)	Peak (dBm)	Avg (dBm)	PAPR (dB)	Limit (dB)	Conclusion
WCDMA Band V (RMC)	4132	826.4	26.20	23.06	3.14	≤13	PASS
	4183	836.6	26.09	22.99	3.10	≤13	PASS
	4233	846.6	26.07	23.12	2.95	≤13	PASS

LTE Band 5								
Modulation	Bandwidth (MHz)	Channel	Frequency (MHz)	Peak (dBm)	Avg (dBm)	PAPR (dB)	Limit (dB)	Conclusion
QPSK	1.4	20407	824.7	29.33	22.86	6.47	≤13	PASS
		20525	836.5	28.79	22.86	5.93	≤13	PASS
		20643	848.3	28.85	22.95	5.90	≤13	PASS
	3	20415	825.5	28.85	23.09	5.76	≤13	PASS
		20525	836.5	28.98	23.07	5.91	≤13	PASS
		20635	847.5	29.34	23.04	6.30	≤13	PASS
	5	20425	826.5	30.20	23.07	7.13	≤13	PASS
		20525	836.5	29.22	23.03	6.19	≤13	PASS
		20625	846.5	29.64	22.99	6.65	≤13	PASS
	10	20450	829	29.01	23.04	5.97	≤13	PASS
		20525	836.5	28.78	22.98	5.80	≤13	PASS
		20600	844	28.70	22.95	5.75	≤13	PASS
16QAM	1.4	20407	824.7	30.69	23.44	7.25	≤13	PASS
		20525	836.5	30.54	22.82	7.72	≤13	PASS
		20643	848.3	29.89	22.85	7.04	≤13	PASS
	3	20415	825.5	29.36	22.73	6.63	≤13	PASS
		20525	836.5	29.79	23.28	6.51	≤13	PASS
		20635	847.5	30.15	23.55	6.60	≤13	PASS
	5	20425	826.5	30.09	22.68	7.41	≤13	PASS
		20525	836.5	30.67	23.26	7.41	≤13	PASS
		20625	846.5	30.91	23.53	7.38	≤13	PASS
	10	20450	829	29.60	22.66	6.94	≤13	PASS
		20525	836.5	29.88	23.22	6.66	≤13	PASS
		20600	844	30.09	23.48	6.61	≤13	PASS

5.6. Frequency Stability

Ambient condition

Temperature	Relative humidity	Pressure
23°C ~25°C	45%~50%	101.5kPa

Method of Measurement

Frequency Stability (Temperature Variation)

The temperature inside the climate chamber is varied from -40°C to +85°C in 10°C step size,

(1) With all power removed, the temperature was decreased to 0°C and permitted to stabilize for three hours.

(2) Measure the carrier frequency with the test equipment in a “call mode”. These measurements should be made within 1 minute of powering up the mobile station, to prevent significant self warming.

(3) Repeat the above measurements at 10°C increments from -40°C to +85°. Allow at least 1.5 hours at each temperature, un-powered, before making measurements.

Frequency Stability (Voltage Variation)

The frequency stability shall be measured with variation of primary supply voltage as follows:

(1) Vary primary supply voltage from 85 to 115 percent of the nominal value for other than hand carried battery equipment.

(2) For hand carried, battery powered equipment, reduce primary supply voltage to the battery-operating end point which shall be specified by the manufacturer.

This transceiver is specified to operate with an input voltage of between 3.3 V and 4.3 V, with a nominal voltage of 3.8V.

Test setup

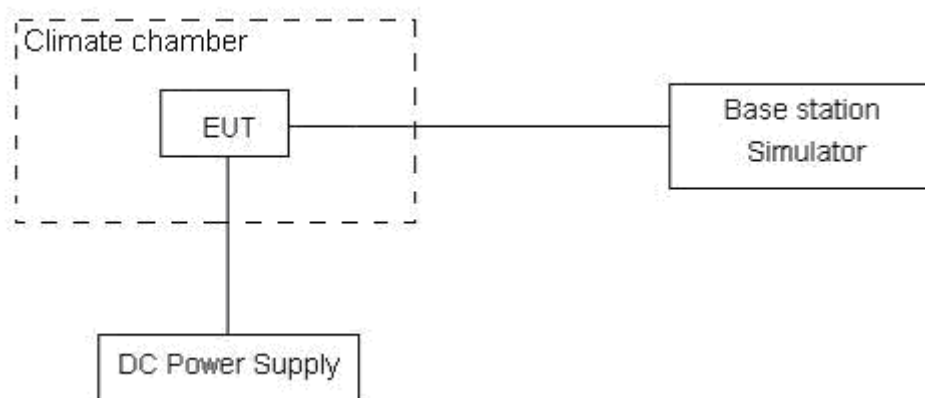

**Limits**

According to the Sec. 22.355, the frequency stability of the carrier shall be accurate to within 2.5 ppm of the received frequency for mobile stations.

Limits	≤ 2.5 ppm
--------	----------------

Measurement Uncertainty

The assessed measurement uncertainty to ensure 99.75% confidence level for the normal distribution is with the coverage factor $k = 3$, $U = 0.01$ ppm.

Test Result

WCDMA Band 5					
Condition		824	849	Delta (Hz)	Frequency Stability (ppm)
Temperature	Voltage	F low@-13dBm(MHz)	F high@-13dBm(MHz)		
Normal (25°C)	Normal	824.0309	848.9667	-5.69	-0.00680
Extreme (85°C)		824.0277	848.9681	-2.12	-0.00253
Extreme (80°C)		824.0316	848.9639	-2.60	-0.00311
Extreme (70°C)		824.0297	848.9660	-4.94	-0.00590
Extreme (60°C)		824.0311	848.9644	-0.79	-0.00094
Extreme (50°C)		824.0305	848.9650	-1.76	-0.00210
Extreme (40°C)		824.0292	848.9663	-2.69	-0.00321
Extreme (30°C)		824.0285	848.9670	-4.68	-0.00559
Extreme (20°C)		824.0306	848.9649	0.33	0.00040
Extreme (10°C)		824.0294	848.9661	-1.79	-0.00214
Extreme (0°C)		824.0307	848.9650	-2.63	-0.00314
Extreme (-10°C)		824.0312	848.9643	-2.46	-0.00294
Extreme (-20°C)		824.0301	848.9654	-4.45	-0.00532
Extreme (-30°C)		824.0271	848.9687	0.56	0.00067
Extreme (-40°C)		824.0256	848.9699	-1.56	-0.00186
25°C	LV	824.0304	848.9651	-0.53	-0.00063
	HV	824.0301	848.9657	-2.09	-0.00249

LTE Band 5					
(QPSK, 10MHz BANDWIDTH)					
Condition		824	849	Delta (Hz)	Frequency Stability(ppm)
Temperature	Voltage	F low@-13dBm(MHz)	F high@-13dBm(MHz)		
Normal (25°C)	Normal	824.2285	848.7889	1.91	0.00228
Extreme (85°C)		824.2274	848.7876	6.74	0.00806
Extreme (80°C)		824.2313	848.7915	6.81	0.00814
Extreme (70°C)		824.2294	848.7896	1.24	0.00148
Extreme (60°C)		824.2308	848.7910	4.49	0.00537
Extreme (50°C)		824.2302	848.7904	3.67	0.00439
Extreme (40°C)		824.2289	848.7891	1.32	0.00158
Extreme (30°C)		824.2282	848.7884	0.60	0.00072
Extreme (20°C)		824.2303	848.7905	11.60	0.01387
Extreme (10°C)		824.2291	848.7893	-6.07	-0.00726



Extreme (0°C)		824.2304	848.7906	9.98	0.01193
Extreme (-10°C)		824.2309	848.7911	-2.31	-0.00276
Extreme (-20°C)		824.2298	848.7900	0.51	0.00061
Extreme (-30°C)		824.2265	848.7870	-2.13	-0.00255
Extreme (-40°C)		824.2253	848.7855	-5.16	-0.00617
25°C	LV	824.2301	848.7903	1.87	0.00224
	HV	824.2295	848.7903	4.96	0.00593
(16QAM,10MHz BANDWIDTH)					
Condition		824	849	Delta (Hz)	Frequency Stability(ppm)
Temperature	Voltage	F low@-13dBm(MHz)	F high@-13dBm(MHz)		
Normal (25°C)	Normal	824.3669	848.7291	-2.30	-0.00275
Extreme (85°C)		824.3680	848.7302	0.55	0.00066
Extreme (80°C)		824.3641	848.7263	2.78	0.00332
Extreme (70°C)		824.3660	848.7282	-2.29	-0.00274
Extreme (60°C)		824.3646	848.7268	-4.21	-0.00503
Extreme (50°C)		824.3652	848.7274	-1.75	-0.00209
Extreme (40°C)		824.3665	848.7290	-2.42	-0.00289
Extreme (30°C)		824.3672	848.7294	-0.98	-0.00117
Extreme (20°C)		824.3651	848.7273	4.06	0.00485
Extreme (10°C)		824.3663	848.7285	-0.26	-0.00031
Extreme (0°C)		824.3650	848.7272	-0.82	-0.00098
Extreme (-10°C)		824.3645	848.7269	1.60	0.00191
Extreme (-20°C)		824.3656	848.7278	-2.07	-0.00247
Extreme (-30°C)		824.3689	848.7311	-4.80	-0.00574
Extreme (-40°C)		824.3701	848.7323	2.50	0.00299
25°C	LV	824.3653	848.7275	-1.78	-0.00213
	HV	824.3659	848.7281	-0.89	-0.00106

5.7. Spurious Emissions at Antenna Terminals

Ambient condition

Temperature	Relative humidity	Pressure
23°C ~25°C	45%~50%	101.5kPa

Method of Measurement

The EUT was connected to Spectrum Analyzer and Base Station Simulator via power Splitter. The measurement is carried out using a spectrum analyzer. The spectrum analyzer scans from 9kHz to the 10th harmonic of the carrier.

The peak detector is used. RBW are set to 100 kHz and VBW are set to 300 kHz for below 1G, RBW are set to 1MHz and VBW are set to 3MHz for above 1G, Sweep is set to ATUO.

The modulation mode and RB allocation refer to section 5.1, using the maximum output power configuration.

Test setup

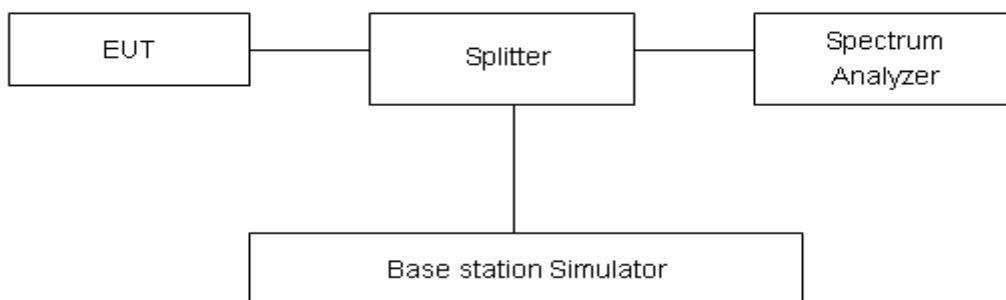

Limits

Rule Part 22.917(a) specifies that “The power of any emission outside of the authorized operating frequency ranges must be attenuated below the transmitting power (P) by a factor of at least 43 + 10 log (P) dB.”

Limit	-13 dBm
-------	---------

Measurement Uncertainty

The assessed measurement uncertainty to ensure 99.75% confidence level for the normal distribution is with the coverage factor $k = 1.96$.

Frequency	Uncertainty
9kHz-1GHz	0.684 dB
1GHz-18GHz	1.407 dB

Test Result

Sweep the whole frequency band through the range from 9kHz to the 10th harmonic of the carrier, the emissions more than 20 dB below the limit are not reported.

The signal beyond the limit is carrier.

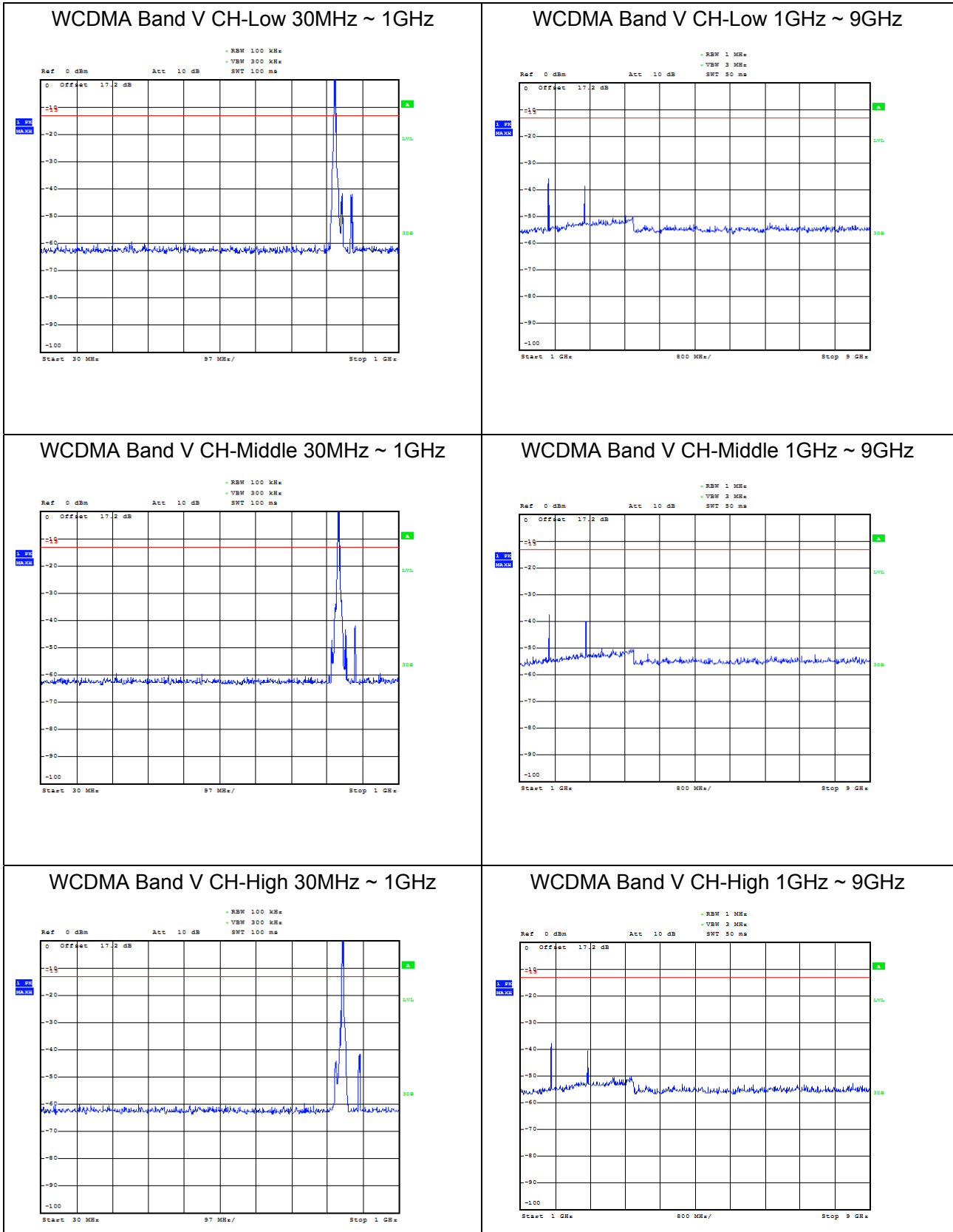



LTE Band 5 1.4MHz CH-Low 30MHz~1GHz

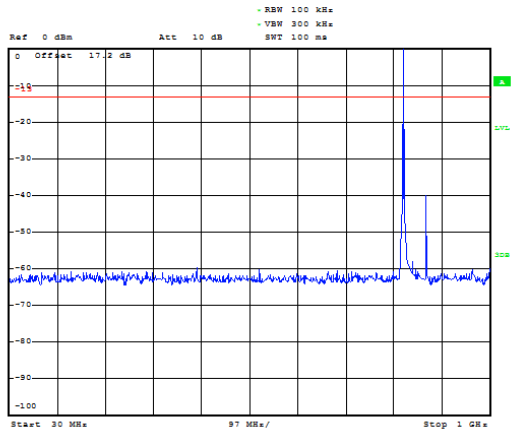

LTE Band 5 1.4MHz CH-Low 1GHz~9GHz

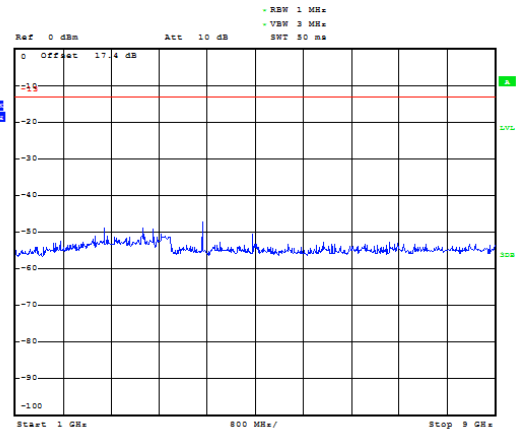

LTE Band 5 1.4MHz CH-Middle 30MHz~1GHz

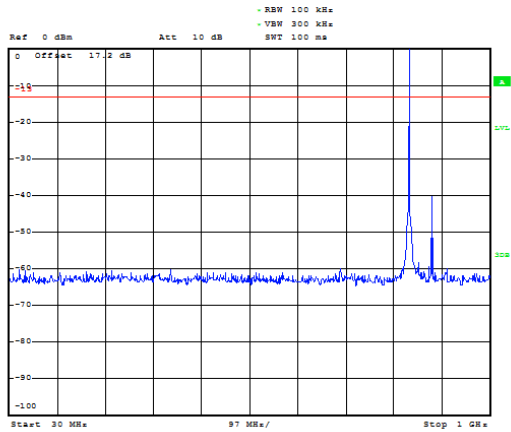

LTE Band 5 1.4MHz CH-Middle 1GHz~9GHz

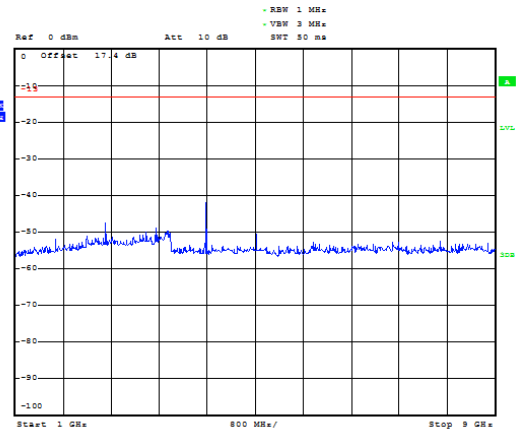

LTE Band 5 1.4MHz CH-High 30MHz~1GHz

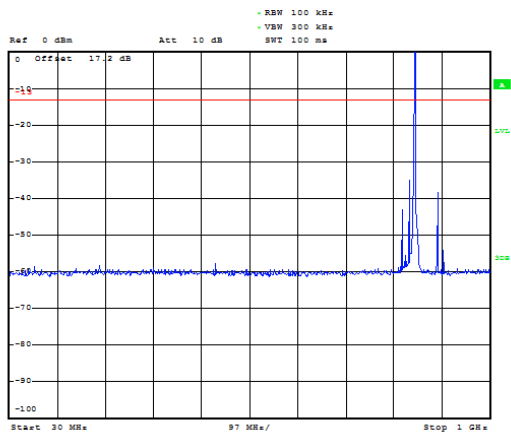

LTE Band 5 1.4MHz CH-High 1GHz~9GHz

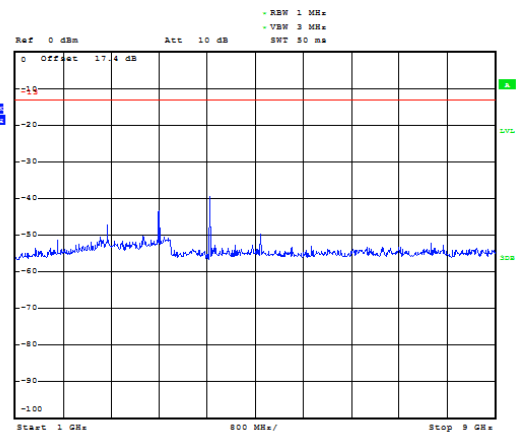



LTE Band 5 3MHz CH-Low 30MHz~1GHz

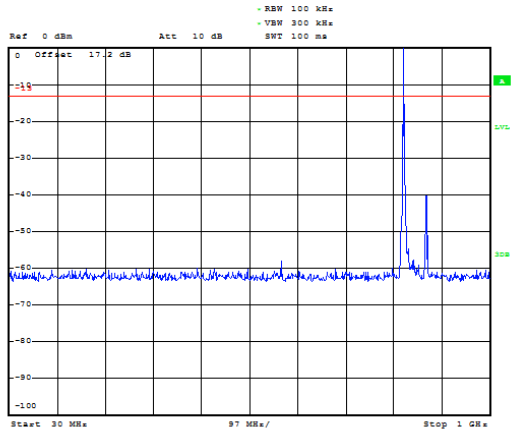

LTE Band 5 3MHz CH-Low 1GHz~9GHz

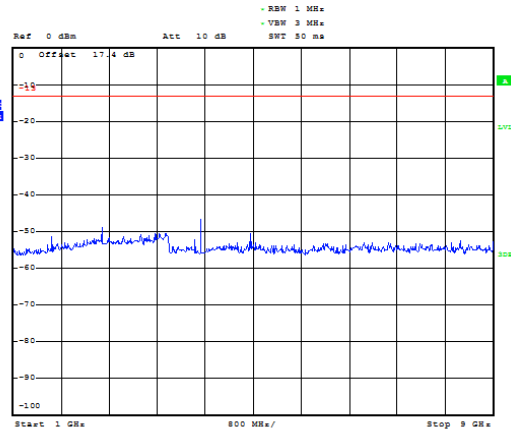

LTE Band 5 3MHz CH-Middle 30MHz~1GHz

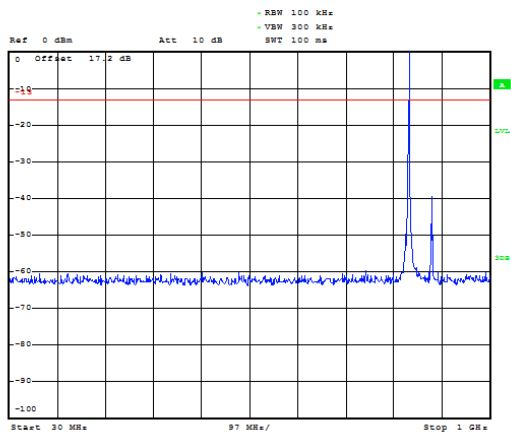

LTE Band 5 3MHz CH-Middle 1GHz~9GHz

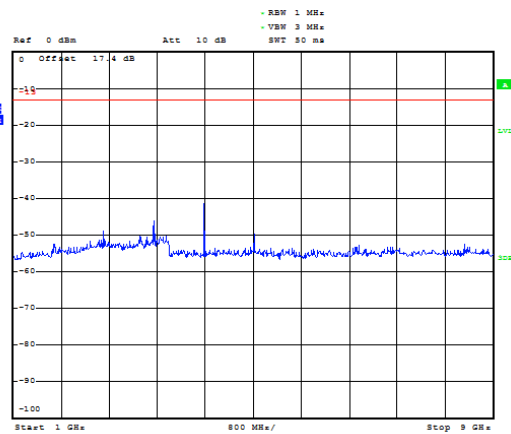

LTE Band 5 3MHz CH-High 30MHz~1GHz

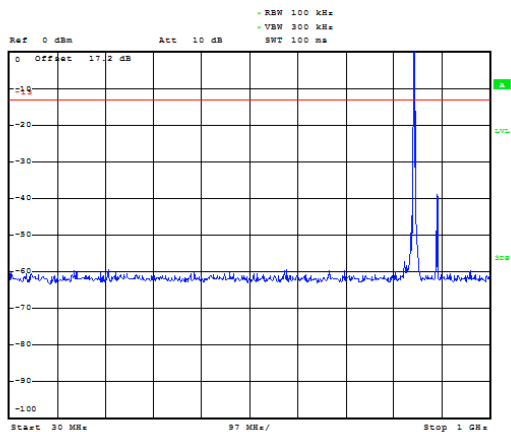

LTE Band 5 3MHz CH-High 1GHz~9GHz

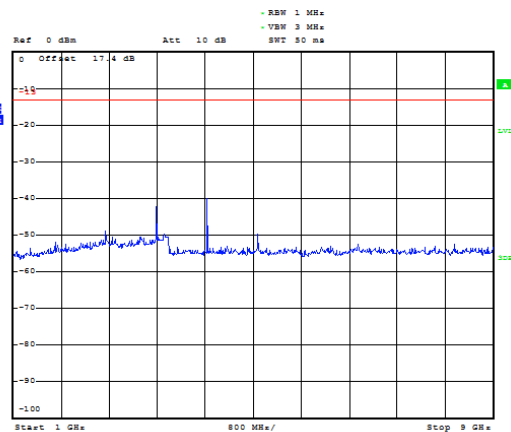



LTE Band 5 5MHz CH-Low 30MHz~1GHz

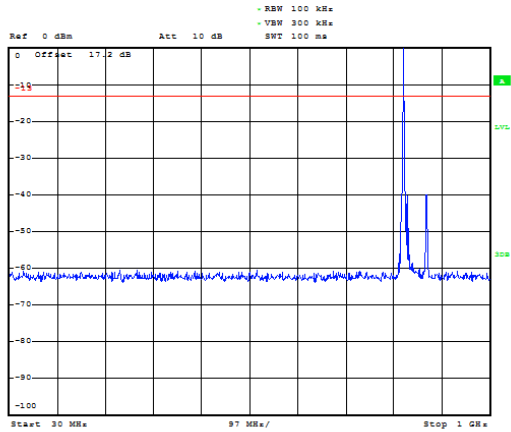

LTE Band 5 5MHz CH-Low 1GHz~9GHz

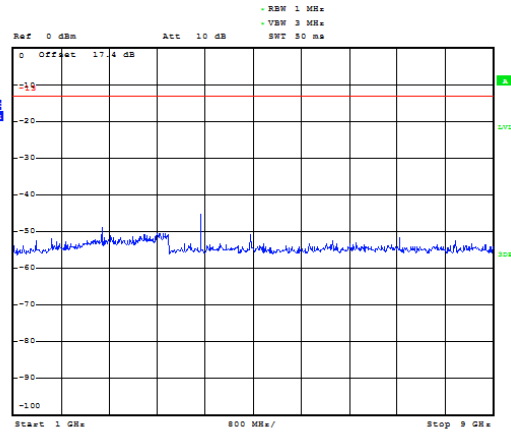

LTE Band 5 5MHz CH-Middle 30MHz~1GHz

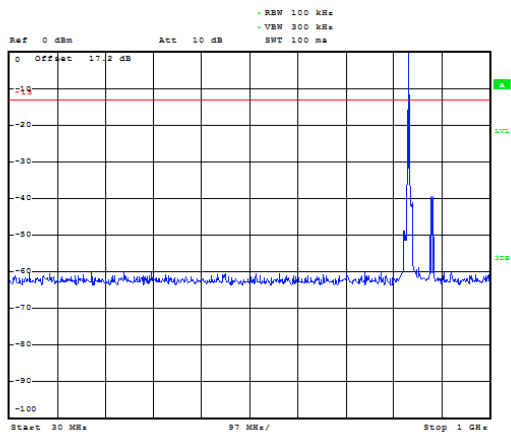

LTE Band 5 5MHz CH-Middle 1GHz~9GHz

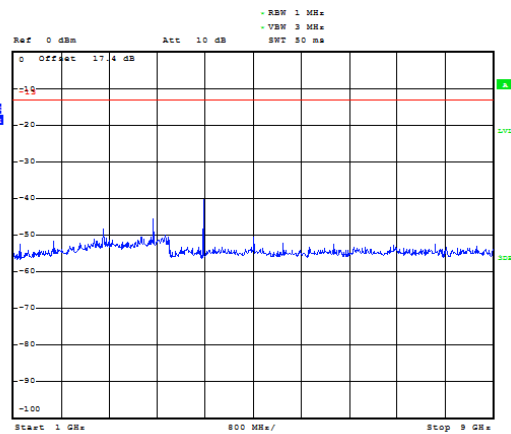

LTE Band 5 5MHz CH-High 30MHz~1GHz

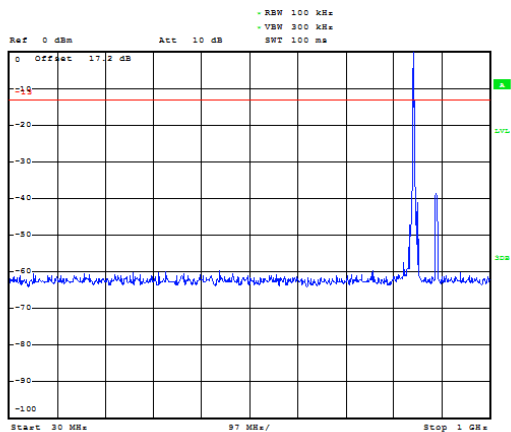

LTE Band 5 5MHz CH-High 1GHz~9GHz

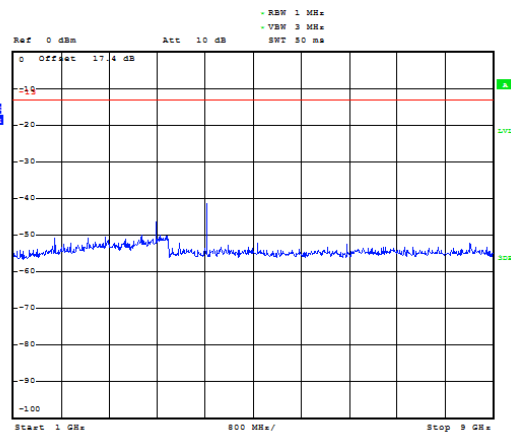



LTE Band 5 10MHz CH-Low 30MHz~1GHz

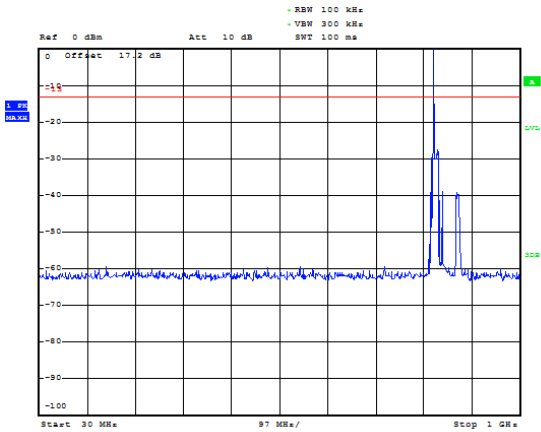

LTE Band 5 10MHz CH-Low 1GHz~9GHz

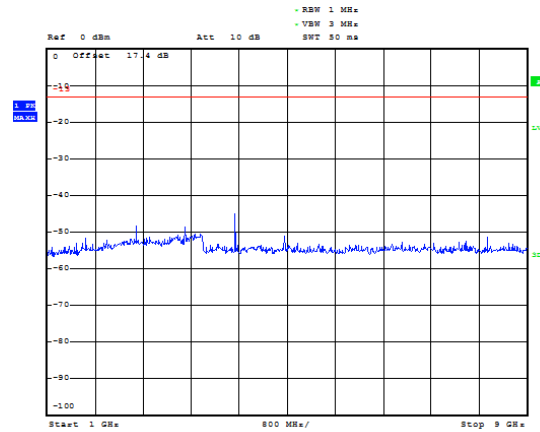

LTE Band 5 10MHz CH-Middle 30MHz~1GHz

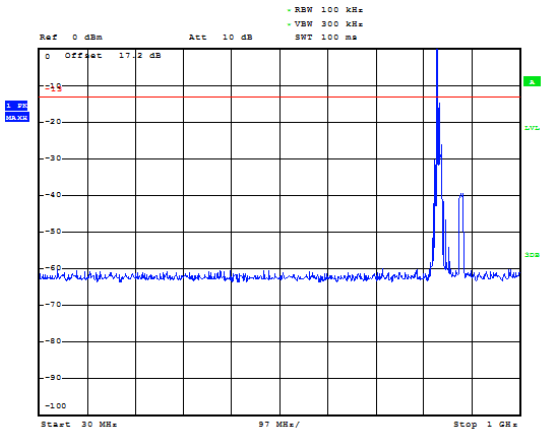

LTE Band 5 10MHz CH-Middle 1GHz~9GHz

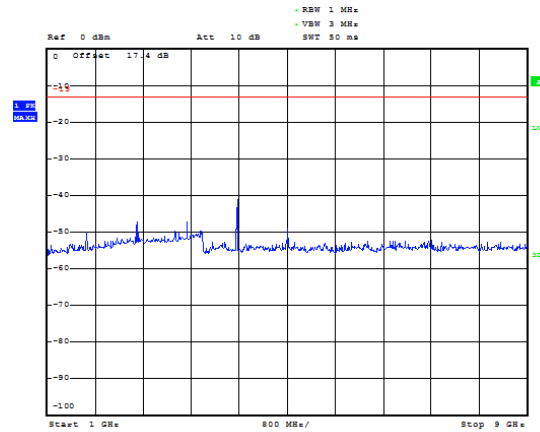

LTE Band 5 10MHz CH-High 30MHz~1GHz

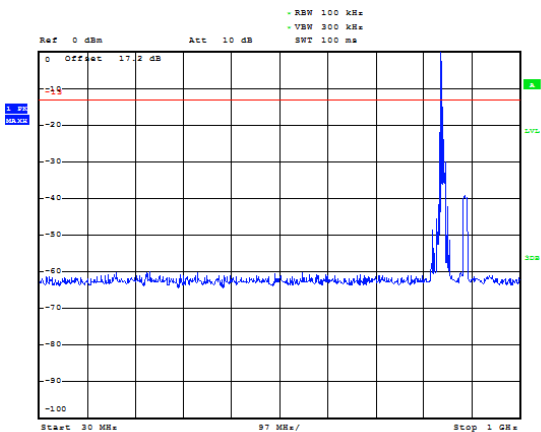

LTE Band 5 10MHz CH-High 1GHz~9GHz

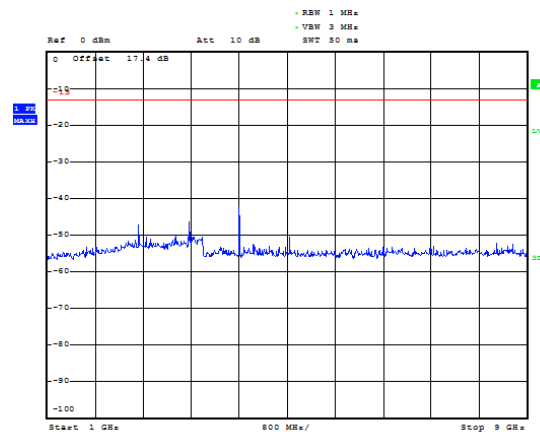

5.8. Radiates Spurious Emission

Ambient condition

Temperature	Relative humidity	Pressure
23°C ~25°C	45%~50%	101.5kPa

Method of Measurement

1. The testing follows FCC KDB 971168 v03r01 Section 5.8 and ANSI/TIA-603-E (2016).
2. The EUT is placed on a turntable 0.8 meters above the ground in the chamber, 3 meter away from the antenna. The maximal emission value is acquired by adjusting the antenna height, polarisation and turntable azimuth. Normally, the height range of antenna is 1 m to 4 m, the azimuth range of turntable is 0° to 360°, and the receive antenna has two polarizations Vertical (V) and Horizontal (H).
3. A log-periodic antenna or double-ridged waveguide horn antenna shall be substituted in place of the EUT. The log-periodic antenna will be driven by a signal generator and the level will be adjusted till the same power value on the spectrum analyzer or receiver. The level of the spurious emissions can be calculated through the level of the signal generator, cable loss, the gain of the substitution antenna and the reading of the spectrum analyzer or receiver.
4. The EUT is then put into continuously transmitting mode at its maximum power level during the test. Set Test Receiver or Spectrum RBW=1MHz, VBW=3MHz for above 1GHz and RBW=100kHz, VBW=300kHz for 30MHz to 1GHz, And the maximum value of the receiver should be recorded as (Pr).
5. The EUT shall be replaced by a substitution antenna. In the chamber, an substitution antenna for the frequency band of interest is placed at the reference point of the chamber. An RF Signal source for the frequency band of interest is connected to the substitution antenna with a cable that has been constructed to not interfere with the radiation pattern of the antenna. A power (PMea) is applied to the input of the substitution antenna, and adjust the level of the signal generator output until the value of the receiver reach the previously recorded (Pr). The power of signal source (PMea) is recorded. The test should be performed by rotating the test item and adjusting the receiving antenna polarization.
6. A amplifier should be connected to the Signal Source output port. And the cable should be connect between the Amplifier and the Substitution Antenna. The cable loss (Pcl), the Substitution Antenna Gain (Ga) and the Amplifier Gain (PAg) should be recorded after test.
7. The measurement results are obtained as described below:
Power(EIRP)=PMea- PAg - Pcl + Ga
The measurement results are amend as described below:
Power(EIRP)=PMea- Pcl + Ga
8. This value is EIRP since the measurement is calibrated using an antenna of known gain (2.15 dBi) and known input power. ERP can be calculated from EIRP by subtracting the gain of the dipole, ERP = EIRP-2.15dBi.
The modulation mode and RB allocation refer to section 5.1, using the maximum output power configuration.

Test setup

30MHz~~~ 1GHz

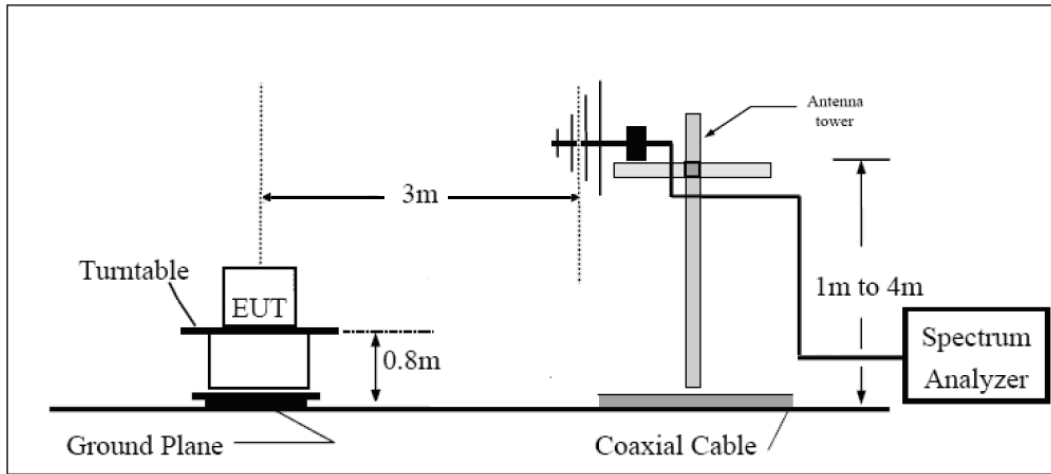

Above 1GHz

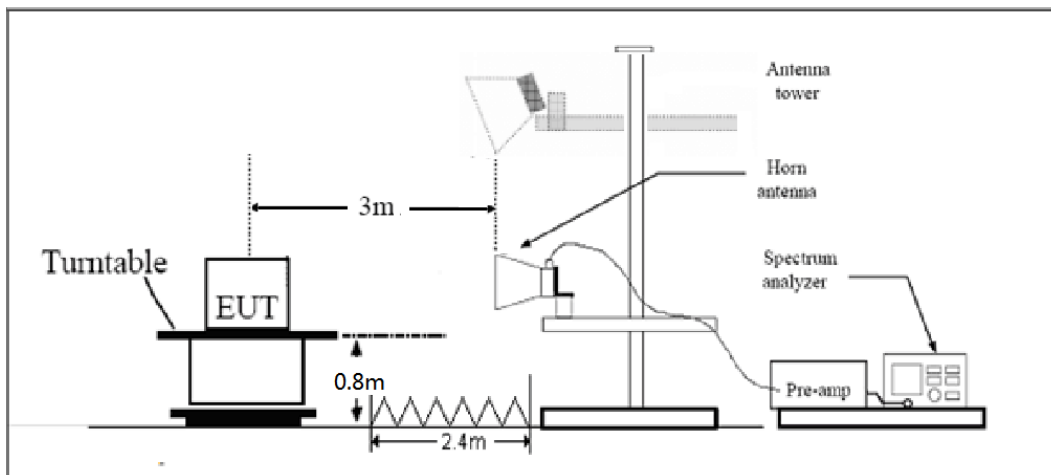

Note: Area side:2.4mX3.6m

Limits

Rule Part 22.917(a) specifies that “The power of any emission outside of the authorized operating frequency ranges must be attenuated below the transmitting power (P) by a factor of at least $43 + 10 \log (P)$ dB.”

Limit	-13 dBm
-------	---------

Measurement Uncertainty

The assessed measurement uncertainty to ensure 95% confidence level for the normal distribution is with the coverage factor $k = 1.96$, $U = 3.55$ dB.

**Test Result**

Sweep the whole frequency band through the range from 30MHz to the 10th harmonic of the carrier, the emissions below the noise floor will not be recorded in the report.

WCDMA Band V CH-Low

Harmonic	Frequency (MHz)	SG (dBm)	Cable Loss (dB)	Gain (dBi)	Antenna Polarization	ERP Level (dBm)	Limit (dBm)	Margin (dB)	Azimuth (deg)
2	1652.8	-59.80	2	10.15	Horizontal	-53.80	-13.00	40.80	45
3	2479.2	-60.39	2.51	11.35	Horizontal	-53.70	-13.00	40.70	135
4	3305.6	-61.70	4.2	10.85	Horizontal	-57.20	-13.00	44.20	315
5	4132.0	-58.90	5.2	11.35	Horizontal	-54.90	-13.00	41.90	90
6	4958.4	-57.90	5.5	11.95	Horizontal	-53.60	-13.00	40.60	135
7	5784.8	-57.90	5.7	13.55	Horizontal	-52.20	-13.00	39.20	225
8	6611.2	-55.00	6.3	13.75	Horizontal	-49.70	-13.00	36.70	270
9	7437.6	-51.70	6.8	13.85	Horizontal	-46.80	-13.00	33.80	315
10	8264.0	-51.80	6.9	14.25	Horizontal	-46.60	-13.00	33.60	0

Note: 1.The other Spurious RF Radiated emissions level is no more than noise floor.
2.The worst emission was found in the antenna is Horizontal position.

WCDMA Band V CH-Middle

Harmonic	Frequency (MHz)	SG (dBm)	Cable Loss (dB)	Gain (dBi)	Antenna Polarization	ERP Level (dBm)	Limit (dBm)	Margin (dB)	Azimuth (deg)
2	1673.2	-60.90	2	10.75	Horizontal	-54.30	-13.00	41.30	225
3	2509.8	-60.99	2.51	11.05	Horizontal	-54.60	-13.00	41.60	0
4	3346.4	-62.70	4.2	11.15	Horizontal	-57.90	-13.00	44.90	90
5	4183.0	-59.60	5.2	11.15	Horizontal	-55.80	-13.00	42.80	135
6	5019.6	-56.60	5.5	11.95	Horizontal	-52.30	-13.00	39.30	225
7	5856.2	-57.80	5.7	13.55	Horizontal	-52.10	-13.00	39.10	315
8	6692.8	-55.10	6.3	13.75	Horizontal	-49.80	-13.00	36.80	0
9	7529.4	-51.50	6.8	13.85	Horizontal	-46.60	-13.00	33.60	45
10	8366.0	-54.30	6.9	14.25	Horizontal	-49.10	-13.00	36.10	90

Note: 1.The other Spurious RF Radiated emissions level is no more than noise floor.
2.The worst emission was found in the antenna is Horizontal position.

WCDMA Band V CH-High

Harmonic	Frequency (MHz)	SG (dBm)	Cable Loss (dB)	Gain (dBi)	Antenna Polarization	ERP Level (dBm)	Limit (dBm)	Margin (dB)	Azimuth (deg)
2	1693.2	-59.30	2	10.15	Horizontal	-53.30	-13.00	40.30	0
3	2539.8	-61.29	2.51	11.05	Horizontal	-54.90	-13.00	41.90	90
4	3386.4	-62.10	4.2	11.15	Horizontal	-57.30	-13.00	44.30	0
5	4233.0	-58.30	5.2	11.15	Horizontal	-54.50	-13.00	41.50	135
6	5079.6	-56.30	5.5	11.95	Horizontal	-52.00	-13.00	39.00	315
7	5926.2	-57.80	5.7	13.55	Horizontal	-52.10	-13.00	39.10	270
8	6772.8	-56.20	6.3	13.75	Horizontal	-50.90	-13.00	37.90	225
9	7619.4	-51.80	6.8	13.85	Horizontal	-46.90	-13.00	33.90	45
10	8466.0	-54.60	6.9	14.25	Horizontal	-49.40	-13.00	36.40	90

Note: 1.The other Spurious RF Radiated emissions level is no more than noise floor.
 2.The worst emission was found in the antenna is Horizontal position.

LTE Band 5 1.4MHz CH-Low

Harmonic	Frequency (MHz)	SG (dBm)	Cable Loss (dB)	Gain (dBi)	Antenna Polarization	ERP Level (dBm)	Limit (dBm)	Margin (dB)	Azimuth (deg)
2	1649.4	-61.40	2.00	10.75	Horizontal	-54.80	-13.00	41.80	180
3	2474.1	-51.49	2.51	11.05	Horizontal	-45.10	-13.00	32.10	45
4	3298.8	-60.60	4.20	11.15	Horizontal	-55.80	-13.00	42.80	90
5	4123.5	-59.00	5.20	11.15	Horizontal	-55.20	-13.00	42.20	0
6	4948.2	-56.70	5.50	11.95	Horizontal	-52.40	-13.00	39.40	90
7	5772.9	-57.80	5.70	13.55	Horizontal	-52.10	-13.00	39.10	45
8	6597.6	-55.50	6.30	13.75	Horizontal	-50.20	-13.00	37.20	180
9	7422.3	-52.50	6.80	13.85	Horizontal	-47.60	-13.00	34.60	315
10	8247.0	-52.80	6.90	14.25	Horizontal	-47.60	-13.00	34.60	45

Note: 1.The other Spurious RF Radiated emissions level is no more than noise floor.
 2.The worst emission was found in the antenna is Horizontal position.

LTE Band 5 1.4MHz CH-Middle

Harmonic	Frequency (MHz)	SG (dBm)	Cable Loss (dB)	Gain (dBi)	Antenna Polarization	ERP Level (dBm)	Limit (dBm)	Margin (dB)	Azimuth (deg)
2	1673.0	-58.00	2.00	10.75	Horizontal	-51.40	-13.00	38.40	90
3	2509.5	-55.49	2.51	11.05	Horizontal	-49.10	-13.00	36.10	0
4	3346.0	-60.20	4.20	11.15	Horizontal	-55.40	-13.00	42.40	0
5	4182.5	-59.10	5.20	11.15	Horizontal	-55.30	-13.00	42.30	180
6	5019.0	-56.80	5.50	11.95	Horizontal	-52.50	-13.00	39.50	315
7	5855.5	-58.00	5.70	13.55	Horizontal	-52.30	-13.00	39.30	45
8	6692.0	-56.10	6.30	13.75	Horizontal	-50.80	-13.00	37.80	0
9	7528.5	-52.60	6.80	13.85	Horizontal	-47.70	-13.00	34.70	45
10	8365.0	-52.30	6.90	14.25	Horizontal	-47.10	-13.00	34.10	90

Note: 1.The other Spurious RF Radiated emissions level is no more than noise floor.
 2.The worst emission was found in the antenna is Horizontal position.

LTE Band 5 1.4MHz CH-High

Harmonic	Frequency (MHz)	SG (dBm)	Cable Loss (dB)	Gain (dBi)	Antenna Polarization	ERP Level (dBm)	Limit (dBm)	Margin (dB)	Azimuth (deg)
2	1696.6	-56.70	2.00	10.75	Horizontal	-50.10	-13.00	37.10	90
3	2544.9	-56.59	2.51	11.05	Horizontal	-50.20	-13.00	37.20	45
4	3393.2	-60.00	4.20	11.15	Horizontal	-55.20	-13.00	42.20	135
5	4241.5	-57.20	5.20	11.15	Horizontal	-53.40	-13.00	40.40	180
6	5089.8	-55.90	5.50	11.95	Horizontal	-51.60	-13.00	38.60	45
7	5938.1	-56.90	5.70	13.55	Horizontal	-51.20	-13.00	38.20	90
8	6786.4	-54.90	6.30	13.75	Horizontal	-49.60	-13.00	36.60	0
9	7634.7	-52.20	6.80	13.85	Horizontal	-47.30	-13.00	34.30	180
10	8483.0	-52.00	6.90	14.25	Horizontal	-46.80	-13.00	33.80	315

Note: 1.The other Spurious RF Radiated emissions level is no more than noise floor.
 2.The worst emission was found in the antenna is Horizontal position.

LTE Band 5 5MHz CH-Low

Harmonic	Frequency (MHz)	SG (dBm)	Cable Loss (dB)	Gain (dBi)	Antenna Polarization	ERP Level (dBm)	Limit (dBm)	Margin (dB)	Azimuth (deg)
2	1653.0	-62.70	2.00	10.75	Horizontal	-56.10	-13.00	43.10	180
3	2479.5	-51.39	2.51	11.05	Horizontal	-45.00	-13.00	32.00	315
4	3356.3	-60.90	4.20	11.15	Horizontal	-56.10	-13.00	43.10	45
5	4007.6	-58.90	5.20	11.15	Horizontal	-55.10	-13.00	42.10	0
6	4994.3	-57.40	5.50	11.95	Horizontal	-53.10	-13.00	40.10	180
7	5961.8	-58.10	5.70	13.55	Horizontal	-52.40	-13.00	39.40	315
8	6796.8	-56.60	6.30	13.75	Horizontal	-51.30	-13.00	38.30	45
9	7631.8	-53.10	6.80	13.85	Horizontal	-48.20	-13.00	35.20	0
10	8466.8	-53.00	6.90	14.25	Horizontal	-47.80	-13.00	34.80	315

Note: 1.The other Spurious RF Radiated emissions level is no more than noise floor.
 2.The worst emission was found in the antenna is Horizontal position.

LTE Band 5 5MHz CH-Middle

Harmonic	Frequency (MHz)	SG (dBm)	Cable Loss (dB)	Gain (dBi)	Antenna Polarization	ERP Level (dBm)	Limit (dBm)	Margin (dB)	Azimuth (deg)
2	1673.0	-56.40	2.00	10.75	Horizontal	-49.80	-13.00	36.80	45
3	2509.5	-55.49	2.51	11.05	Horizontal	-49.10	-13.00	36.10	180
4	3466.2	-60.70	4.20	11.15	Horizontal	-55.90	-13.00	42.90	135
5	4215.9	-58.80	5.20	11.15	Horizontal	-55.00	-13.00	42.00	180
6	5165.6	-56.90	5.50	11.95	Horizontal	-52.60	-13.00	39.60	45
7	5815.3	-57.80	5.70	13.55	Horizontal	-52.10	-13.00	39.10	90
8	6765.0	-56.00	6.30	13.75	Horizontal	-50.70	-13.00	37.70	0
9	7614.7	-52.70	6.80	13.85	Horizontal	-47.80	-13.00	34.80	90
10	8464.4	-52.60	6.90	14.25	Horizontal	-47.40	-13.00	34.40	45

Note: 1.The other Spurious RF Radiated emissions level is no more than noise floor.
 2.The worst emission was found in the antenna is Horizontal position.



LTE Band 5 5MHz CH-High

Harmonic	Frequency (MHz)	SG (dBm)	Cable Loss (dB)	Gain (dBi)	Antenna Polarization	ERP Level (dBm)	Limit (dBm)	Margin (dB)	Azimuth (deg)
2	1693.0	-56.20	2.00	10.75	Horizontal	-49.60	-13.00	36.60	315
3	2539.5	-54.79	2.51	11.05	Horizontal	-48.40	-13.00	35.40	45
4	3386.0	-60.10	4.20	11.15	Horizontal	-55.30	-13.00	42.30	180
5	4232.5	-58.40	5.20	11.15	Horizontal	-54.60	-13.00	41.60	315
6	5079.0	-56.10	5.50	11.95	Horizontal	-51.80	-13.00	38.80	45
7	5925.5	-56.80	5.70	13.55	Horizontal	-51.10	-13.00	38.10	0
8	6772.0	-54.70	6.30	13.75	Horizontal	-49.40	-13.00	36.40	45
9	7618.5	-51.90	6.80	13.85	Horizontal	-47.00	-13.00	34.00	90
10	8465.0	-52.00	6.90	14.25	Horizontal	-46.80	-13.00	33.80	315

Note: 1.The other Spurious RF Radiated emissions level is no more than noise floor.

2.The worst emission was found in the antenna is Horizontal position.

LTE Band 5 10MHz CH-Low

Harmonic	Frequency (MHz)	SG (dBm)	Cable Loss (dB)	Gain (dBi)	Antenna Polarization	ERP Level (dBm)	Limit (dBm)	Margin (dB)	Azimuth (deg)
2	1658.0	-61.00	2.00	10.75	Horizontal	-54.40	-13.00	41.40	0
3	2487.0	-51.09	2.51	11.05	Horizontal	-44.70	-13.00	31.70	45
4	3316.0	-59.90	4.20	11.15	Horizontal	-55.10	-13.00	42.10	135
5	4145.0	-58.50	5.20	11.15	Horizontal	-54.70	-13.00	41.70	45
6	4974.0	-58.20	5.50	11.95	Horizontal	-53.90	-13.00	40.90	0
7	5803.0	-58.00	5.70	13.55	Horizontal	-52.30	-13.00	39.30	315
8	6632.0	-56.50	6.30	13.75	Horizontal	-51.20	-13.00	38.20	135
9	7461.0	-53.20	6.80	13.85	Horizontal	-48.30	-13.00	35.30	180
10	8290.0	-52.70	6.90	14.25	Horizontal	-47.50	-13.00	34.50	45

Note: 1.The other Spurious RF Radiated emissions level is no more than noise floor.

2.The worst emission was found in the antenna is Horizontal position.



LTE Band 5 10MHz CH-Middle

Harmonic	Frequency (MHz)	SG (dBm)	Cable Loss (dB)	Gain (dBi)	Antenna Polarization	ERP Level (dBm)	Limit (dBm)	Margin (dB)	Azimuth (deg)
2	1673.0	-55.00	2.00	10.75	Horizontal	-48.40	-13.00	35.40	90
3	2509.5	-52.59	2.51	11.05	Horizontal	-46.20	-13.00	33.20	135
4	3346.0	-59.60	4.20	11.15	Horizontal	-54.80	-13.00	41.80	90
5	4182.5	-58.20	5.20	11.15	Horizontal	-54.40	-13.00	41.40	45
6	5019.0	-58.10	5.50	11.95	Horizontal	-53.80	-13.00	40.80	90
7	5855.5	-58.10	5.70	13.55	Horizontal	-52.40	-13.00	39.40	315
8	6692.0	-55.50	6.30	13.75	Horizontal	-50.20	-13.00	37.20	135
9	7528.5	-52.50	6.80	13.85	Horizontal	-47.60	-13.00	34.60	45
10	8365.0	-52.50	6.90	14.25	Horizontal	-47.30	-13.00	34.30	0

Note: 1.The other Spurious RF Radiated emissions level is no more than noise floor.

2.The worst emission was found in the antenna is Horizontal position.

LTE Band 5 10MHz CH-High

Harmonic	Frequency (MHz)	SG (dBm)	Cable Loss (dB)	Gain (dBi)	Antenna Polarization	ERP Level (dBm)	Limit (dBm)	Margin (dB)	Azimuth (deg)
2	1688.0	-59.60	2.00	10.75	Horizontal	-53.00	-13.00	40.00	180
3	2532.0	-52.79	2.51	11.05	Horizontal	-46.40	-13.00	33.40	45
4	3376.0	-59.10	4.20	11.15	Horizontal	-54.30	-13.00	41.30	315
5	4220.0	-57.50	5.20	11.15	Horizontal	-53.70	-13.00	40.70	135
6	5064.0	-45.60	5.50	11.95	Horizontal	-41.30	-13.00	28.30	180
7	5908.0	-46.10	5.70	13.55	Horizontal	-40.40	-13.00	27.40	45
8	6752.0	-55.00	6.30	13.75	Horizontal	-49.70	-13.00	36.70	90
9	7596.0	-52.50	6.80	13.85	Horizontal	-47.60	-13.00	34.60	315
10	8440.0	-51.70	6.90	14.25	Horizontal	-46.50	-13.00	33.50	135

Note: 1.The other Spurious RF Radiated emissions level is no more than noise floor.

2.The worst emission was found in the antenna is Horizontal position.

6. Main Test Instruments

Name	Manufacturer	Type	Serial Number	Calibration Date	Expiration Date
Base Station Simulator	R&S	CMW500	113824	2018-05-20	2019-05-19
Power Splitter	Hua Xiang	SHX-GF2-2-13	10120101	NA	NA
Spectrum Analyzer	Agilent	N9010A	MY47191109	2018-05-20	2019-05-19
Universal Radio Communication Tester	Agilent	E5515C	MY48367192	2018-05-20	2019-05-19
Signal Analyzer	R&S	FSV30	100815	2017-12-17	2018-12-16
EMI Test Receiver	R&S	ESCI	100948	2018-05-20	2019-05-19
Signal generator	R&S	SMB 100A	102594	2018-05-13	2019-05-12
Signal generator	R&S	SMR27	100365	2018-05-14	2019-05-13
Loop Antenna	SCHWARZBECK	FMZB1519	1519-047	2014-12-06	2019-12-05
Trilog Antenna	SCHWARZBECK	VUBL 9163	9163-201	2017-11-18	2020-11-17
Horn Antenna	R&S	HF907	100126	2014-12-06	2019-12-05
Horn Antenna	ETS-Lindgren	3160-09	00102644	2015-01-30	2020-01-29
Climatic Chamber	Re Ce	PT-30B	20101891	2015-07-18	2018-07-17
RF Cable	Agilent	SMA 15cm	0001	2018-02-03	2018-08-02
Preamplifier	R&S	SCU18	102327	2018-05-20	2019-05-19
Software	R&S	EMC32	V 8.52.0	NA	NA
MOB COMMS DC SUPPLY	Keysight	66319D	MY43004105	2018-05-07	2019-05-06

*****END OF REPORT *****

ANNEX A: EUT Appearance and Test Setup

A.1 EUT Appearance

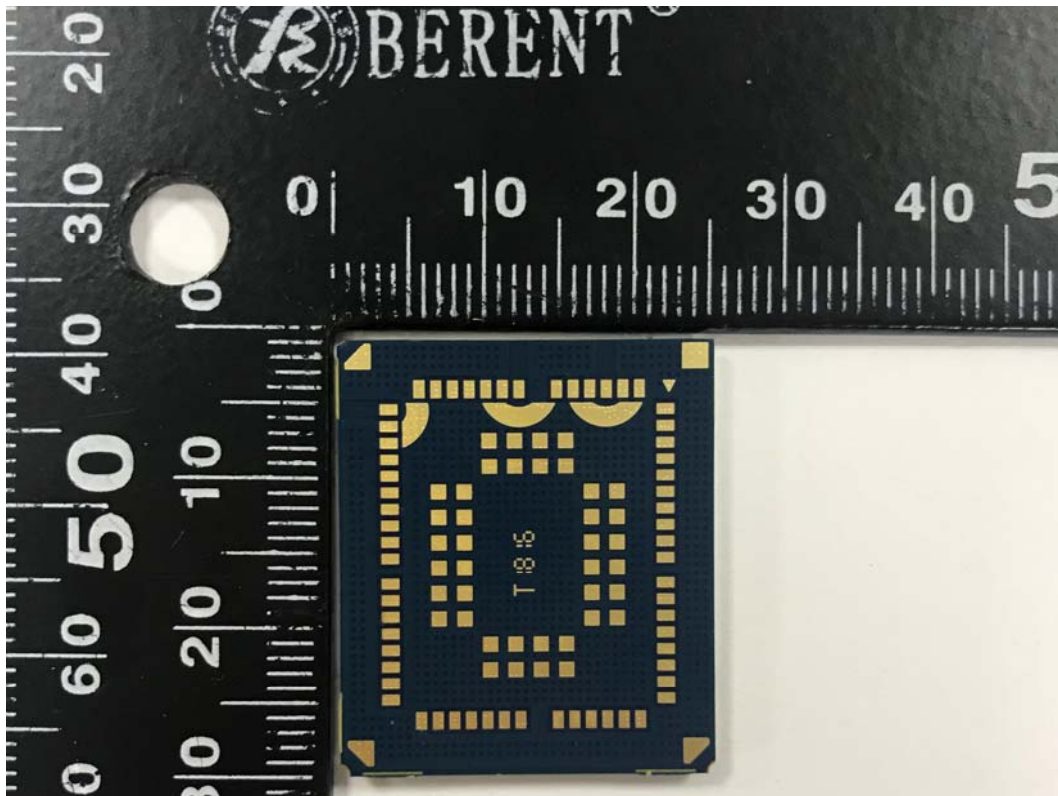

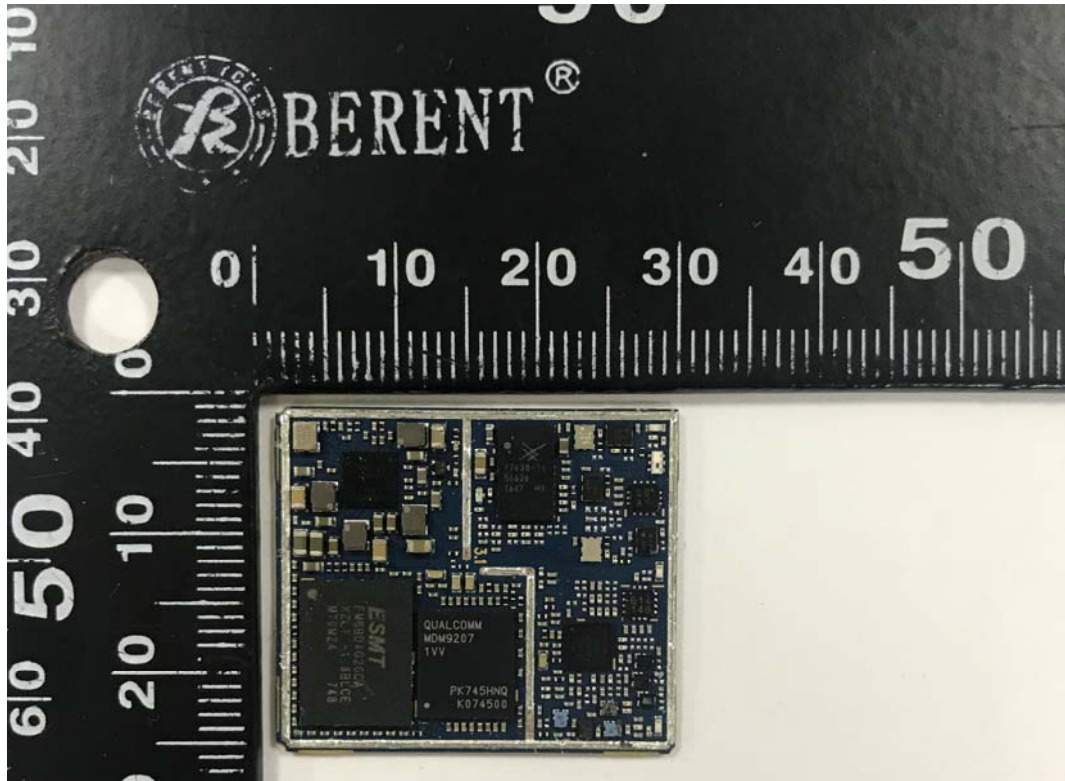

a: EUT

Picture 1 EUT and Accessory

A.2 Test Setup



Picture 2: Radiated Spurious Emissions Test setup