

FCC/ISED

RF

TEST REPORT

ISSUED BY  
Shenzhen BALUN Technology Co., Ltd.



FOR  
**HALO Connect Gateway**

ISSUED TO  
Aperia Technologies

1616 Rollins Road, Burlingame, CA 94010



Tested by: Heng Aiping  
Heng Aiping  
(Engineer)

Date: Apr 11, 2019

Approved by: Wei Yanquan  
Wei Yanquan  
(Chief Engineer)

Date: Apr 11, 2019

Report No.: BL-HK18C0003-601  
EUT Name: HALO Connect Gateway  
Model Name: GW-10 (refer to section 2.4)  
Brand Name: Aperia Technologies  
Test Standard: 47 CFR Part 15 Subpart C  
RSS-Gen (Issue 5, April 2018)  
RSS-247 (Issue 2, February 2017)  
FCC ID: 2ARY2-HALOC  
ISED Number: 24637-HALOC

Test Conclusion: Pass  
Test Date: Dec. 03, 2018 ~ Dec. 14, 2018  
Date of Issue: Apr. 11, 2019

*NOTE: This test report of test results only related to testing samples, which can be duplicated completely for the legal use with the approval of the applicant; it shall not be reproduced except in full, without the written approval of Shenzhen BALUN Technology Co., Ltd. Any objections should be raised within thirty days from the date of issue. To validate the report, please contact us.*

**Revision History**

<u>Version</u>	<u>Issue Date</u>	<u>Revisions Content</u>
<u>Rev. 01</u>	<u>Mar. 20, 2019</u>	<u>Initial Issue</u>
<u>Rev. 02</u>	<u>Apr. 11, 2019</u>	<u>Revised the note for retest items on page 10 of BT TR.</u>

**TABLE OF CONTENTS**

- 1 ADMINISTRATIVE DATA (GENERAL INFORMATION) ..... 5
  - 1.1 Identification of the Testing Laboratory ..... 5
  - 1.2 Identification of the Responsible Testing Location ..... 5
  - 1.3 Laboratory Condition ..... 5
  - 1.4 Announce ..... 5
- 2 PRODUCT INFORMATION ..... 6
  - 2.1 Applicant Information ..... 6
  - 2.2 Manufacturer Information ..... 6
  - 2.3 Factory Information ..... 6
  - 2.4 General Description for Equipment under Test (EUT) ..... 6
  - 2.5 Ancillary Equipment ..... 6
  - 2.6 Technical Information ..... 7
  - 2.7 Additional Instructions ..... 8
- 3 SUMMARY OF TEST RESULTS ..... 9
  - 3.1 Test Standards ..... 9
  - 3.2 Verdict ..... 10
- 4 GENERAL TEST CONFIGURATIONS ..... 11
  - 4.1 Test Environments ..... 11
  - 4.2 Test Equipment List ..... 11
  - 4.3 Measurement Uncertainty ..... 12
  - 4.4 Description of Test Setup ..... 13
    - 4.4.1 For Antenna Port Test ..... 13
    - 4.4.2 For AC Power Supply Port Test ..... 13
    - 4.4.3 For Radiated Test (Below 30 MHz) ..... 14
    - 4.4.4 For Radiated Test (30 MHz-1 GHz) ..... 14
    - 4.4.5 For Radiated Test (Above 1 GHz) ..... 15

4.5	Measurement Results Explanation Example.....	16
4.5.1	For conducted test items: .....	16
4.5.2	For radiated band edges and spurious emission test:.....	16
5	TEST ITEMS .....	17
5.1	Antenna Requirements.....	17
5.1.1	Relevant Standards.....	17
5.1.2	Antenna Anti-Replacement Construction .....	17
5.1.3	Antenna Gain .....	17
5.2	Output Power .....	18
5.2.1	Test Limit.....	18
5.2.2	Test Setup.....	18
5.2.3	Test Procedure.....	18
5.2.4	Test Result .....	19
5.3	Occupied Bandwidth.....	20
5.3.1	Limit.....	20
5.3.2	Test Setup.....	20
5.3.3	Test Procedure.....	20
5.3.4	Test Result .....	20
5.4	Conducted Spurious Emission.....	21
5.4.1	Limit.....	21
5.4.2	Test Setup.....	21
5.4.3	Test Procedure.....	21
5.4.4	Test Result .....	22
5.5	Band Edge (Authorized-band band-edge).....	23
5.5.1	Limit.....	23
5.5.2	Test Setup.....	23
5.5.3	Test Procedure.....	23
5.5.4	Test Result .....	23
5.6	Conducted Emission.....	24
5.6.1	Limit.....	24
5.6.2	Test Setup.....	24
5.6.3	Test Procedure.....	24
5.6.4	Test Result .....	24

5.7	Radiated Spurious Emission.....	25
5.7.1	Limit.....	25
5.7.2	Test Setup.....	25
5.7.3	Test Procedure.....	25
5.7.4	Test Result.....	28
5.8	Band Edge (Restricted-band band-edge).....	29
5.8.1	Limit.....	29
5.8.2	Test Setup.....	29
5.8.3	Test Procedure.....	29
1.1.1	Test Result.....	29
5.9	Power Spectral density (PSD).....	30
5.9.1	Limit.....	30
5.9.2	Test Setup.....	30
5.9.3	Test Procedure.....	30
5.9.4	Test Result.....	30
ANNEX A	TEST RESULT.....	31
A.1	Output Power, E.I.R.P, Duty Cycle.....	31
A.2	Occupied Bandwidth.....	33
A.3	Conducted Spurious Emissions.....	33
A.4	Band Edge (Authorized-band band-edge).....	33
A.5	Conducted Emissions.....	34
A.6	Radiated Spurious Emission.....	36
A.7	Band Edge (Restricted-band band-edge).....	44
A.8	Power Spectral Density (PSD).....	45
ANNEX B	TEST SETUP PHOTOS.....	46
ANNEX C	EUT EXTERNAL PHOTOS.....	46
ANNEX D	EUT INTERNAL PHOTOS.....	46

# 1 ADMINISTRATIVE DATA (GENERAL INFORMATION)

## 1.1 Identification of the Testing Laboratory

Company Name	Shenzhen BALUN Technology Co., Ltd.
Address	Block B, 1st FL, Baisha Science and Technology Park, Shahe Xi Road, Nanshan District, Shenzhen, Guangdong Province, P. R. China
Phone Number	+86 755 6685 0100

## 1.2 Identification of the Responsible Testing Location

Test Location	Shenzhen BALUN Technology Co., Ltd.
Address	Block B, 1st FL, Baisha Science and Technology Park, Shahe Xi Road, Nanshan District, Shenzhen, Guangdong Province, P. R. China
Accreditation Certificate	<p>The laboratory has been listed by Industry Canada to perform electromagnetic emission measurements. The recognition numbers of test site are 11524A-1.</p> <p>The laboratory is a testing organization accredited by FCC as a accredited testing laboratory. The designation number is CN1196.</p> <p>The laboratory is a testing organization accredited by American Association for Laboratory Accreditation(A2LA) according to ISO/IEC 17025.The accreditation certificate is 4344.01.</p> <p>The laboratory is a testing organization accredited by China National Accreditation Service for Conformity Assessment (CNAS) according to ISO/IEC 17025. The accreditation certificate number is L6791.</p>
Description	All measurement facilities used to collect the measurement data are located at Block B, FL 1, Baisha Science and Technology Park, Shahe Xi Road, Nanshan District, Shenzhen, Guangdong Province, P. R. China 518055

## 1.3 Laboratory Condition

Ambient Temperature	20°C to 25°C
Ambient Relative Humidity	45% to 55%
Ambient Pressure	100 kPa to 102 kPa

## 1.4 Announce

- (1) The test report reference to the report template version v6.6.
- (2) The test report is invalid if not marked with the signatures of the persons responsible for preparing and approving the test report.
- (3) The test report is invalid if there is any evidence and/or falsification.
- (4) The results documented in this report apply only to the tested sample, under the conditions and modes of operation as described herein.
- (5) This document may not be altered or revised in any way unless done so by BALUN and all revisions are duly noted in the revisions section.
- (6) Content of the test report, in part or in full, cannot be used for publicity and/or promotional purposes without prior written approval from the laboratory.

## 2 PRODUCT INFORMATION

### 2.1 Applicant Information

Applicant	Aperia Technologies
Address	1616 Rollins Road, Burlingame, CA 94010

### 2.2 Manufacturer Information

Manufacturer	Volansys Technologies Pvt Ltd.
Address	A-503, Mondeal Square, Near Crown Plaza Hotel, S. G Highway, Ahmedabad 380 015, Gujarat.

### 2.3 Factory Information

Factory	Volansys Technologies Pvt Ltd.
Address	A-503, Mondeal Square, Near Crown Plaza Hotel, S. G Highway, Ahmedabad 380 015, Gujarat.

### 2.4 General Description for Equipment under Test (EUT)

EUT Name	HALO Connect Gateway
Model Name Under Test	GW-10
Series Model Name	GW-10, GW-20
Description of Model name differentiation	Only change of sub-1GHz Rx receiver modules as below: Model No.: GW-10 (for xBR type sub-1GHz Rx) Model No.: GW-20 (for cc1310 type sub-1GHz Rx)
Hardware Version	REV A2
Software Version	RC1
Dimensions (Approx.)	L=7.5 inch, W=4.375 inch, H=1.97 inch
Weight (Approx.)	435gm (with battery inside)

### 2.5 Ancillary Equipment

Ancillary Equipment 1	Battery	
	Brand Name	Howell
	Model No.	HWE 606090
	Serial No.	HW606090
	Capacity	4000 mAh
	Rated Voltage	3.7 V
	Limit Charge Voltage	4.2 V
Ancillary Equipment 2	GPS Antenna	
Ancillary Equipment 3	LTE Antenna	
Ancillary Equipment 4	Sub-1GHz (433MHz) Antenna	
Ancillary Equipment 5	Power Line	
	Length (Approx.)	2.0 m

## 2.6 Technical Information

Network and Wireless connectivity	3G Network WCDMA/HSDPA/HSUPA Band 2/4/5 4G Network FDD LTE Band 2/4/5/12/13 Bluetooth 4.2 BLE Zigbee, GPS, 433 MHz Only RX
-----------------------------------	---

The requirement for the following technical information of the EUT was tested in this report:

Modulation Technology	DTS
Modulation Type	GFSK
Product Type	<input checked="" type="checkbox"/> Mobile <input type="checkbox"/> Portable <input type="checkbox"/> Fix Location
Transfer Rate	1 Mbps
Frequency Range	The frequency range used is 2400 MHz to 2483.5 MHz.
Number of channel	40 (at intervals of 2 MHz)
Tested Channel	0 (2402 MHz), 20 (2442 MHz), 39 (2480 MHz)
Antenna Type	PCB Antenna
Antenna Gain	-1.61 dBi (In test items related to antenna gain, the final results reflect this figure.)
Antenna Impedance	50Ω
Antenna System(MIMO Smart Antenna)	N/A

## 2.7 Additional Instructions

EUT Software Settings:

Mode	<input checked="" type="checkbox"/> Special software is used. The software provided by client to enable the EUT under transmission condition continuously at specific channel frequencies individually.
------	--

Power level setup in software			
Test Software Version	Tera Term VT		
Support Units (Software installation media)	Description	Manufacturer	Model
	Notebook	DELL	N/A
Mode	Channel	Frequency (MHz)	Soft Set
GFSK	CH0	2402	TX LEVEL is built-in set parameters and cannot be changed and selected.
	CH20	2442	
	CH39	2480	

Run Software

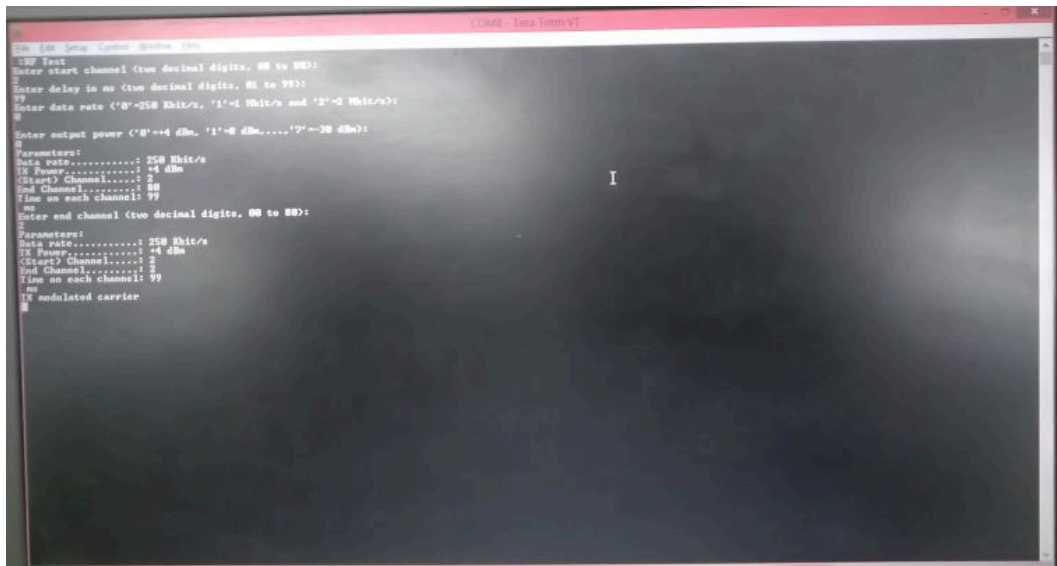



### 3 SUMMARY OF TEST RESULTS

#### 3.1 Test Standards

No.	Identity	Document Title
1	47 CFR Part 15, Subpart C (10-1-17 Edition)	Miscellaneous Wireless Communications Services
2	KDB 558074 D01 15.247 Meas Guidance v05r01	Guidance for compliance measurements on digital transmission system, frequency hopping spread spectrum system, and hybrid system devices operating under section 15.247 of the FCC rules
3	RSS-Gen (Issue 5, April 2018)	General Requirements for Compliance of Radio Apparatus
4	RSS-247 (Issue 2, February 2017)	Digital Transmission Systems (DTSSs), Frequency Hopping Systems(FHSSs) and Licence-Exemp Local Area Network (LE-LAN) Devices
5	ANSI C63.10-2013	American National Standard for Testing Unlicensed Wireless Devices

### 3.2 Verdict

No.	Description	FCC Part No.	ISED Part No.	Channel	Test Result	Verdict
1	Antenna Requirement	15.203	RSS-247, 5.4 (6)	N/A	--	Pass <sup>Note1</sup>
2	Output Power	15.247(b)	RSS-247, 5.4 (4)	Low/Middle/High	ANNEX A.1	Pass
3	Occupied Bandwidth	15.247(a)	RSS-GEN, 6.6; RSS-247, 5.2 (1)	Low/Middle/High	ANNEX A.2	Pass
4	Conducted Spurious Emission	15.247(d)	RSS-247, 5.5	Low/Middle/High	ANNEX A.3	Pass
5	Band Edge(Authorized-band band-edge)	15.247(d)	RSS-247, 5.5;	Low/ High	ANNEX A.4	Pass
6	Conducted Emission	15.207	RSS-GEN, 8.8	Low/Middle/High	ANNEX A.5	Pass
7	Radiated Spurious Emission	15.209 15.247(d)	RSS-247, 5.5	Low/Middle/High	ANNEX A.6	Pass
8	Band Edge(Restricted-band band-edge)	15.209 15.247(d)	RSS-247, 5.5	Low/Middle/High	ANNEX A.7	Pass
9	Power spectral density (PSD)	15.247(e)	RSS-247, 5.2 (2)	Low/Middle/High	ANNEX A.8	Pass
10	Receiver Spurious Emissions	--	RSS-Gen, 7.1.2	--	N/A	N/A <sup>Note2</sup>

Note <sup>1</sup>: The EUT has a permanently and irreplaceable attached antenna, which complies with the requirement FCC 15.203.

Note <sup>2</sup>: Only radio communication receivers operating in stand-alone mode within the band 30-960 MHz, as well as scanner receivers, are subject to Industry Canada requirements, so this test is not applicable.

Note <sup>3</sup>: The BLE module installed in the EUT is electronically and mechanically identical to the original certified module in the test report No. ER/2016/70009 & ER/2016/70011 (FCC ID: SH6MDBT42Q, IC ID: 8017A-MDBT42Q), which issued by SGS Taiwan Ltd. On Jul. 22, 2016, so just Output Power & Radiated Spurious Emission & Band Edge (Restricted-band band-edge) & Conducted Emission were retested in this report. Other test items please refer to the No. ER/2016/70009 & ER/2016/70011 (FCC ID: SH6MDBT42Q, IC ID: 8017A-MDBT42Q), which issued by SGS Taiwan Ltd. On Jul. 22, 2016.

## 4 GENERAL TEST CONFIGURATIONS

### 4.1 Test Environments

During the measurement, the normal environmental conditions were within the listed ranges:

Relative Humidity	45% to 55%	
Atmospheric Pressure	100 kPa to 102 kPa	
Temperature	NT (Normal Temperature)	+22°C to +25°C
Working Voltage of the EUT	NV (Normal Voltage)	24 V

### 4.2 Test Equipment List

Description	Manufacturer	Model	Serial No.	Cal. Date	Cal. Due
Spectrum Analyzer	ROHDE&SCHWARZ	FSV-30	103118	2018.06.15	2019.06.14
Switch Unit with OSP-B157	ROHDE&SCHWARZ	OSP120	101270	2018.06.15	2019.06.14
EMI Receiver	KEYSIGHT	N9038A	MY53220118	2018.11.07	2019.11.06
EMI Receiver	ROHDE&SCHWARZ	ESRP	101036	2018.06.13	2019.06.12
LISN	SCHWARZBECK	NSLK 8127	8127-687	2018.06.13	2019.06.12
Bluetooth Tester	ROHDE&SCHWARZ	CBT	101005	2018.06.15	2019.06.14
Power Splitter	KMW	DCPD-LDC	1305003215	--	--
Power Sensor	ROHDE&SCHWARZ	NRP-Z21	103971	2018.06.15	2019.06.14
Attenuator (20 dB)	KMW	ZA-S1-201	110617091	2018.10.10	2019.01.09
Attenuator (6 dB)	KMW	ZA-S1-61	1305003189	2018.10.10	2019.01.09
DC Power Supply	ROHDE&SCHWARZ	HMP2020	018141664	2018.06.14	2019.06.13
Temperature Chamber	ANGELANTIONI SCIENCE	NTH64-40A	1310	2018.06.26	2019.06.25
Test Antenna-Loop(9 kHz-30 MHz)	SCHWARZBECK	FMZB 1519	1519-037	2017.11.09	2019.11.08
Test Antenna-Bi-Log(30 MHz-3 GHz)	SCHWARZBECK	VULB 9163	9163-624	2017.07.22	2019.07.21
Test Antenna-Horn(1-18 GHz)	SCHWARZBECK	BBHA 9120D	9120D-1148	2018.07.11	2020.07.10
Test Antenna-Horn(15-26.5 GHz)	SCHWARZBECK	BBHA 9170	9170-305	2018.06.21	2019.06.20
Test Antenna-Horn (18-40 GHz)	A-INFO	LB-180400KF	J211060273	2017.01.06	2019.01.05
Anechoic Chamber	RAINFORD	9m*6m*6m	N/A	2017.02.21	2019.02.20
Anechoic Chamber	EMC Electronic Co., Ltd	20.10*11.60*7.35m	N/A	2017.08.08	2019.08.07
Shielded Enclosure	ChangNing	CN-130701	130703	--	--
Signal Generator	ROHDE&SCHWARZ	SMB100A	177746	2018.06.15	2019.06.14
Power Amplifier	OPHIR RF	5225F	1037	2018.02.16	2019.02.15
Power Amplifier	OPHIR RF	5273F	1016	2018.02.16	2019.02.15
Directional Coupler	Werlantone	C5982-10	109275	N/A	N/A
Directional Coupler	Werlantone	CHP-273E	S00801z-01	N/A	N/A
Feld Strength Meter	Narda	EP601	511WX51129	2018.05.21	2019.05.20

Description	Manufacturer	Model	Serial No.	Cal. Date	Cal. Due
Mouth Simulator	B&K	4227	2423931	2018.11.15	2019.11.14
Sound Calibrator	B&K	4231	2430337	2018.11.15	2019.11.14
Sound Level Meter	B&K	NL-20	00844023	2018.11.15	2019.11.14
Ear Simulator	B&K	4185	2409449	2018.11.15	2019.11.14
Ear Simulator	B&K	4195	2418189	2018.11.15	2019.11.14
Audio analyzer	B&K	UPL 16	100129	2018.11.15	2019.11.14
Software	BALUN	BL410	-	-	-
Cable	ROHDE&SCHWARZ	JUNFLON	APR0914004	2018.10.10	2019.01.09

### 4.3 Measurement Uncertainty

The following measurement uncertainty levels have been estimated for tests performed on the EUT as specified in CISPR 16-4-2.

This uncertainty represents an expanded uncertainty expressed at approximately the 95% confidence level using a coverage factor of  $k=2$ .

Measurement	Value
Occupied Channel Bandwidth	$\pm 4\%$
RF output power, conducted	$\pm 1.4$ dB
Power Spectral Density, conducted	$\pm 2.5$ dB
Unwanted Emissions, conducted	$\pm 2.8$ dB
All emissions, radiated	$\pm 5.4$ dB
Temperature	$\pm 1^\circ\text{C}$
Humidity	$\pm 4\%$

## 4.4 Description of Test Setup

### 4.4.1 For Antenna Port Test

Conducted value (dBm) = Measurement value (dBm) + cable loss (dB)

For example: the measurement value is 10 dBm and the cable loss is 0.5dB, then the conducted value (dBm) = 10 dBm + 0.5 dB = 10.5 dBm

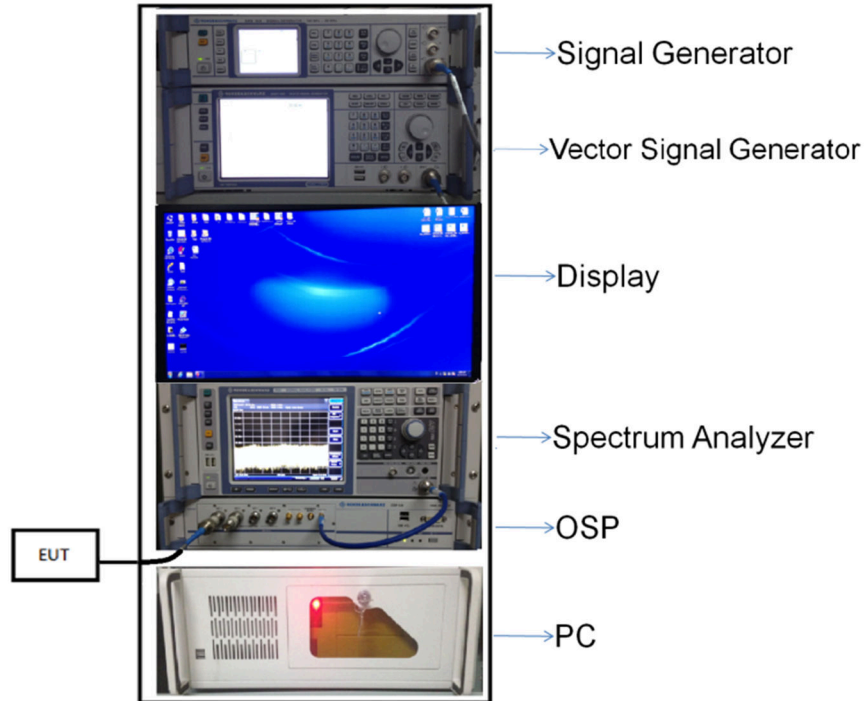

(Diagram 1)

### 4.4.2 For AC Power Supply Port Test

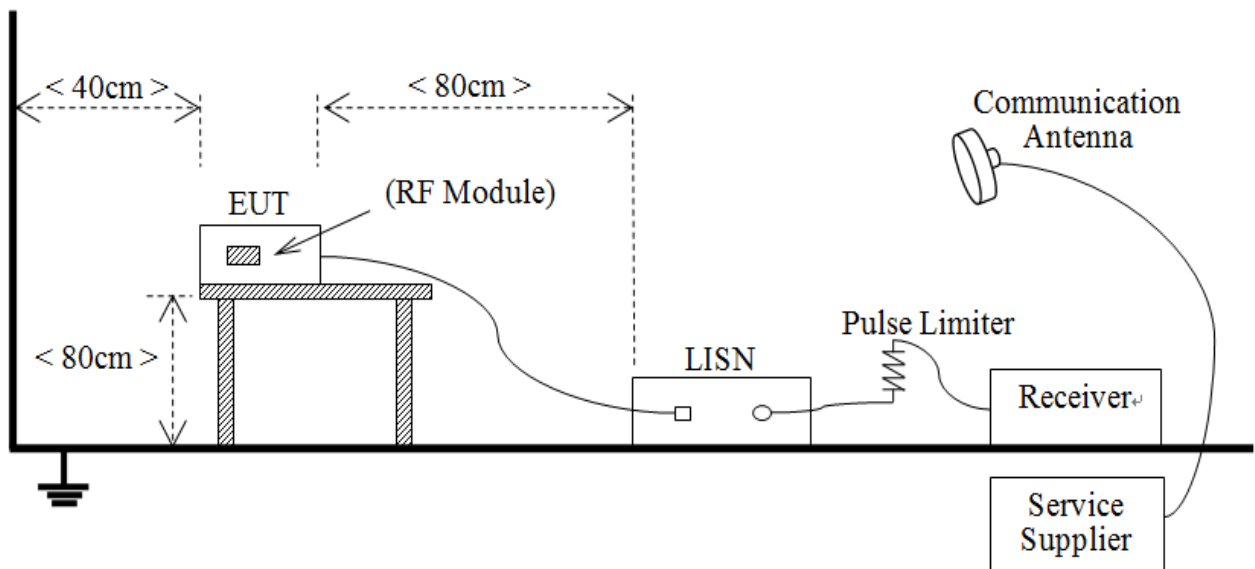

(Diagram 2)

4.4.3 For Radiated Test (Below 30 MHz)

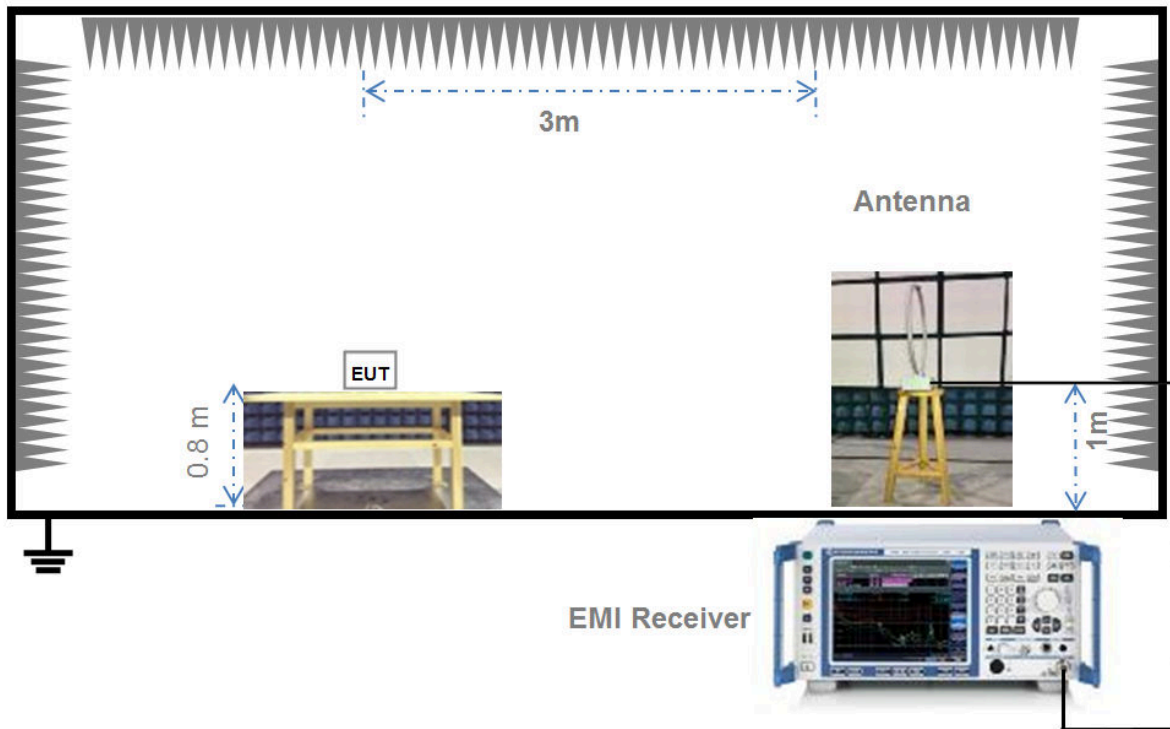

(Diagram 3)

4.4.4 For Radiated Test (30 MHz-1 GHz)

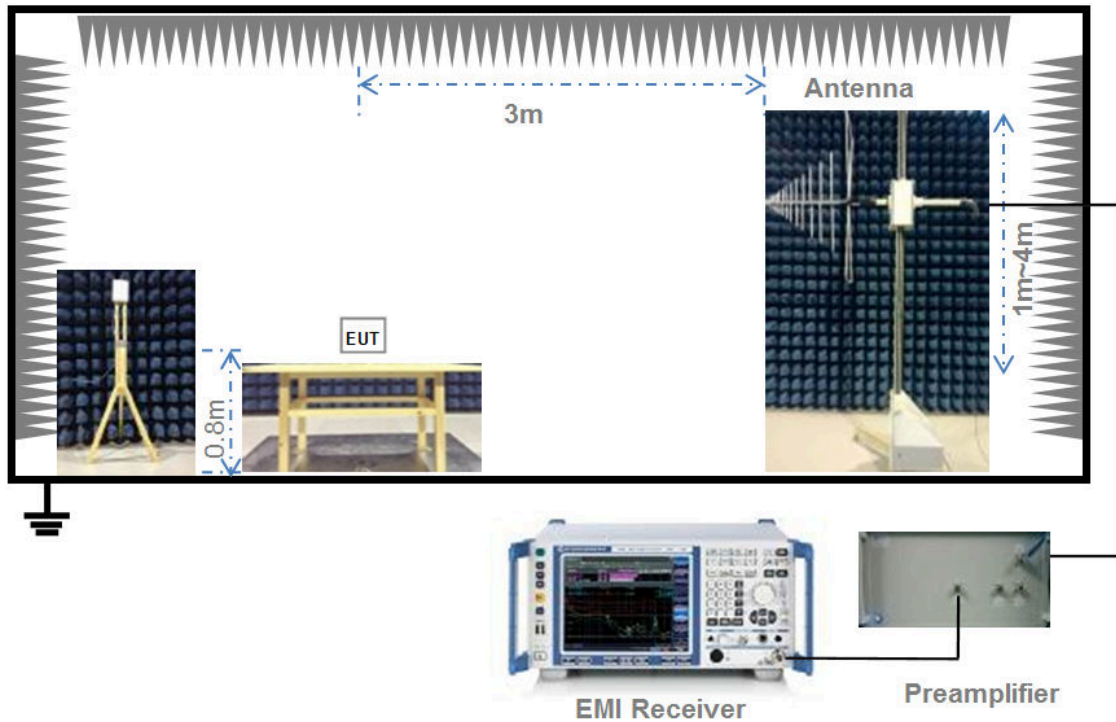

(Diagram 4)

4.4.5 For Radiated Test (Above 1 GHz)

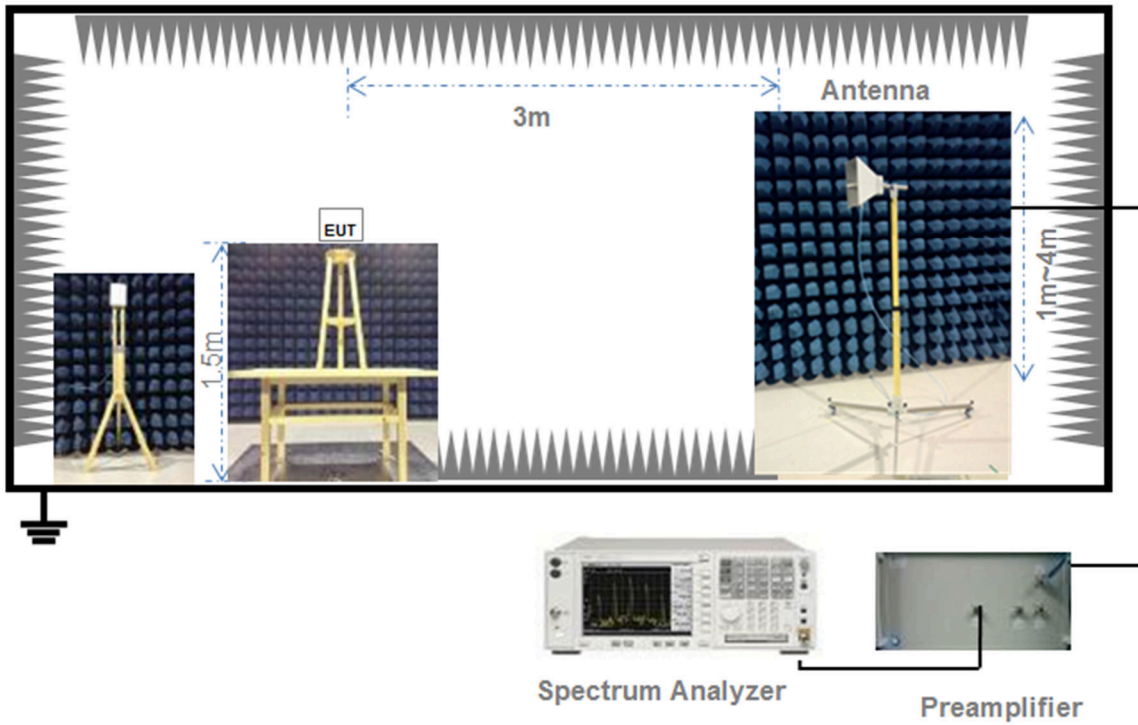

(Diagram 5)

## 4.5 Measurement Results Explanation Example

### 4.5.1 For conducted test items:

The offset level is set in the spectrum analyzer to compensate the RF cable loss and attenuator between EUT conducted output port and spectrum analyzer. With the offset compensation, the spectrum analyzer reading level is exactly the EUT RF output level.

The spectrum analyzer offset is derived from RF cable loss and attenuator factor.

Offset = RF cable loss + attenuator factor.

### 4.5.2 For radiated band edges and spurious emission test:

$$E = \text{EIRP} - 20\log D + 104.8$$

where:

E = electric field strength in dB $\mu$ V/m,

EIRP = equivalent isotropic radiated power in dBm

D = specified measurement distance in meters.



## 5 TEST ITEMS

### 5.1 Antenna Requirements

#### 5.1.1 Relevant Standards

FCC §15.203 & 15.247(b); RSS-247, 5.4 (6)

An intentional radiator shall be designed to ensure that no antenna other than that furnished by the responsible party shall be used with the device. The use of a permanently attached antenna or of an antenna that uses a unique coupling to the intentional radiator shall be considered sufficient to comply with the provisions of this section. The manufacturer may design the unit so that a broken antenna can be replaced by the user, but the use of a standard antenna jack or electrical connector is prohibited. This requirement does not apply to carrier current devices or to devices operated under the provisions of § 15.211, § 15.213, § 15.217, § 15.219, or § 15.221. Further, this requirement does not apply to intentional radiators that must be professionally installed, such as perimeter protection systems and some field disturbance sensors, or to other intentional radiators which, in accordance with § 15.31(d), must be measured at the installation site. However, the installer shall be responsible for ensuring that the proper antenna is employed so that the limits in this part are not exceeded.

If directional gain of transmitting antennas is greater than 6 dBi, the power shall be reduced by the same level in dB comparing to gain minus 6 dBi. For the fixed point-to-point operation, the power shall be reduced by one dB for every 3 dB that the directional gain of the antenna exceeds 6 dBi. The use of a permanently attached antenna or of an antenna that uses a unique coupling to the intentional radiator shall be considered sufficient to comply with the FCC rule.

#### 5.1.2 Antenna Anti-Replacement Construction

The Antenna Anti-Replacement as following method:

Protected Method	Description
The antenna is embedded in the product.	An embedded-in antenna design is used.

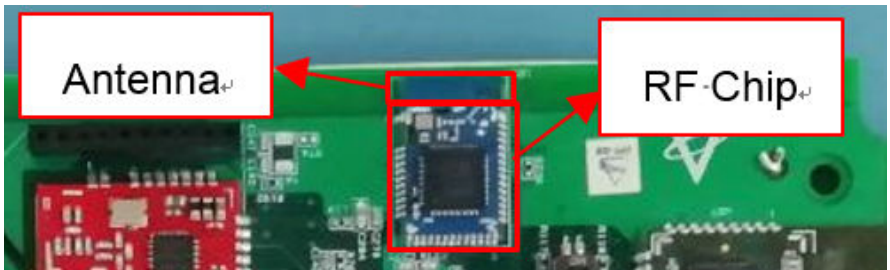
Reference Documents	Item
Photo	

#### 5.1.3 Antenna Gain

The antenna peak gain of EUT is less than 6 dBi. Therefore, it is not necessary to reduce maximum peak output power limit.

## 5.2 Output Power

### 5.2.1 Test Limit

FCC § 15.247(b)

For systems using digital modulation in the 902-928 MHz, 2400-2483.5 MHz, and 5725-5850 MHz bands: 1 Watt. As an alternative to a peak power measurement, compliance with the one Watt limit can be based on a measurement of the maximum conducted output power. Maximum Conducted Output Power is defined as the total transmit power delivered to all antennas and antenna elements averaged across all symbols in the signaling alphabet when the transmitter is operating at its maximum power control level. Power must be summed across all antennas and antenna elements.

RSS-247, 5.4 (4)

For DTSs employing digital modulation techniques operating in the bands 902-928 MHz and 2400-2483.5 MHz, the maximum peak conducted output power shall not exceed 1W. Except as provided in Section 5.4(5), the e.i.r.p. shall not exceed 4 W.

### 5.2.2 Test Setup

See section 4.4.1 for test setup description for the antenna port. The photo of test setup please refer to ANNEX B.

### 5.2.3 Test Procedure

#### a) Maximum peak conducted output power

This procedure shall be used when the measurement instrument has available a resolution bandwidth that is greater than the DTS bandwidth.

Set the RBW  $\geq$  DTS bandwidth.

Set VBW  $\geq 3 \times$  RBW.

Set span  $\geq 3 \times$  RBW

Sweep time = auto couple.

Detector = peak.

Trace mode = max hold.

Allow trace to fully stabilize.

Use peak marker function to determine the peak amplitude level.

#### b) Measurements of duty cycle

The zero-span mode on a spectrum analyzer or EMI receiver if the response time and spacing between bins on the sweep are sufficient to permit accurate measurements of the on and off times of the transmitted signal.

Set the center frequency of the instrument to the center frequency of the transmission.

Set RBW  $\geq$  OBW if possible; otherwise, set RBW to the largest available value.

Set VBW  $\geq$  RBW. Set detector = peak or average.

The zero-span measurement method shall not be used unless both RBW and VBW are  $> 50/T$  and the number of sweep points across duration T exceeds 100. (For example, if VBW and/or RBW are limited to 3 MHz, then the zero-span method of measuring duty cycle shall not be used if  $T \leq 16.7$  microseconds.)

#### 5.2.4 Test Result

Please refer to ANNEX A.1.

## 5.3 Occupied Bandwidth

### 5.3.1 Limit

FCC §15.247(a); RSS-247, 5.1 (1); RSS-GEN, 6.6

Make the measurement with the spectrum analyzer's resolution bandwidth (RBW) = 100 kHz. In order to make an accurate measurement, set the span greater than RBW. The 6 dB bandwidth must be greater than 500 kHz.

### 5.3.2 Test Setup

See section 4.4.1 for test setup description for the antenna port. The photo of test setup please refer to ANNEX B.

### 5.3.3 Test Procedure

Use the following spectrum analyzer settings:

Set RBW = 100 kHz.

Set the video bandwidth (VBW)  $\geq 3$  RBW.

Detector = Peak.

Trace mode = max hold.

Sweep = auto couple.

Allow the trace to stabilize.

Measure the maximum width of the emission that is constrained by the frequencies associated with the two outermost amplitude points (upper and lower frequencies) that are attenuated by 6 dB relative to the maximum level measured in the fundamental emission.

### 5.3.4 Test Result

Please refer to ANNEX A.2.

## 5.4 Conducted Spurious Emission

### 5.4.1 Limit

FCC §15.247(d); RSS-247, 5.5

In any 100 kHz bandwidth outside the frequency band in which the spread spectrum or digitally modulated intentional radiator is operating, the radio frequency power that is produced by the intentional radiator shall be at least 20 dB below that in the 100 kHz bandwidth within the band that contains the highest level of the desired power, based on either an RF conducted or a radiated measurement.

### 5.4.2 Test Setup

See section 4.4.1 for test setup description for the antenna port. The photo of test setup please refer to ANNEX B.

### 5.4.3 Test Procedure

The DTS rules specify that in any 100 kHz bandwidth outside of the authorized frequency band, the power shall be attenuated according to the following conditions:

- a) If the maximum peak conducted output power procedure was used to demonstrate compliance as described in 9.1, then the peak output power measured in any 100 kHz bandwidth outside of the authorized frequency band shall be attenuated by at least 20 dB relative to the maximum in-band peak PSD level in 100 kHz (i.e., 20 dBc).
- b) If maximum conducted (average) output power was used to demonstrate compliance as described in 9.2, then the peak power in any 100 kHz bandwidth outside of the authorized frequency band shall be attenuated by at least 30 dB relative to the maximum in-band peak PSD level in 100 kHz (i.e., 30 dBc).
- c) In either case, attenuation to levels below the 15.209 general radiated emissions limits is not required.

The following procedures shall be used to demonstrate compliance to these limits. Note that these procedures can be used in either an antenna-port conducted or radiated test set-up. Radiated tests must conform to the test site requirements and utilize maximization procedures defined herein.

Reference level measurement:

Establish a reference level by using the following procedure:

Set instrument center frequency to DTS channel center frequency.

Set the span to  $\geq 1.5$  times the DTS bandwidth.

Set the RBW = 100 kHz.

Set the VBW  $\geq 3 \times$  RBW.

Detector = peak.

Sweep time = auto couple.

Trace mode = max hold.

Allow trace to fully stabilize.

Use the peak marker function to determine the maximum PSD level.

Emission level measurement:

Use the following spectrum analyzer settings:

Span = wide enough to capture the peak level of the in-band emission and all spurious emissions (e.g., harmonics) from the lowest frequency generated in the EUT up through the 10th harmonic. Typically, several plots are required to cover this entire span.

Set the RBW = 100 kHz.

Set the VBW  $\geq 3 \times$  RBW.

Detector = peak.

Sweep time = auto couple.

Trace mode = max hold.

Allow trace to fully stabilize.

Use the peak marker function to determine the maximum amplitude level.

Ensure that the amplitude of all unwanted emissions outside of the authorized frequency band (excluding restricted frequency bands) are attenuated by at least the minimum requirements specified in 11.1 a) or 11.1 b). Report the three highest emissions relative to the limit.

#### 5.4.4 Test Result

Please refer to ANNEX A.3.

## 5.5 Band Edge (Authorized-band band-edge)

### 5.5.1 Limit

FCC §15.247(d); RSS-247, 5.5

In any 100 kHz bandwidth outside the frequency band in which the spread spectrum or digitally modulated intentional radiator is operating, the radio frequency power that is produced by the intentional radiator shall be at least 20 dB below that in the 100 kHz bandwidth within the band that contains the highest level of the desired power, based on either an RF conducted or a radiated measurement.

### 5.5.2 Test Setup

See section 4.4.1 for test setup description for the antenna port. The photo of test setup please refer to ANNEX B.

### 5.5.3 Test Procedure

The following procedures may be used to determine the peak or average field strength or power of an unwanted emission that is within 2 MHz of the authorized band edge. If a peak detector is utilized, use the procedure described in 13.2.1. Use the procedure described in 13.2.2 when using an average detector and the EUT can be configured to transmit continuously (i.e., duty cycle  $\geq 98\%$ ). Use the procedure described in 13.2.3 when using an average detector and the EUT cannot be configured to transmit continuously but the duty cycle is constant (i.e., duty cycle variations are less than  $\pm 2$  percent). Use the procedure described in 13.2.4 when using an average detector for those cases where the EUT cannot be configured to transmit continuously and the duty cycle is not constant (duty cycle variations equal or exceed 2 percent).

When using a peak detector to measure unwanted emissions at or near the band edge (within 2 MHz of the authorized band), the following integration procedure can be used.

Set instrument center frequency to the frequency of the emission to be measured (must be within 2 MHz of the authorized band edge).

Set span to 2 MHz

RBW = 100 kHz.

VBW  $\geq 3 \times$  RBW.

Detector = peak.

Sweep time = auto.

Trace mode = max hold.

Allow sweep to continue until the trace stabilizes (required measurement time may increase for low duty cycle applications)

Compute the power by integrating the spectrum over 1 MHz using the analyzer's band power measurement function with band limits set equal to the emission frequency (femission)  $\pm 0.5$  MHz. If the instrument does not have a band power function, then sum the amplitude levels (in power units) at 100 kHz intervals extending across the 1 MHz spectrum defined by femission  $\pm 0.5$  MHz.

### 5.5.4 Test Result

Please refer to ANNEX A.4.

## 5.6 Conducted Emission

### 5.6.1 Limit

FCC §15.207; RSS-GEN, 8.8

For an intentional radiator that is designed to be connected to the public utility (AC) power line, the radio frequency voltage that is conducted back onto the AC power line on any frequency within the band 150 kHz to 30 MHz shall not exceed the limits in the following table, as measured using a 50 $\mu$ H/50 $\Omega$  line impedance stabilization network (LISN).

Frequency range (MHz)	Conducted Limit (dB $\mu$ V)	
	Quai-peak	Average
0.15 - 0.50	66 to 56	56 to 46
0.50 - 5	56	46
0.50 - 30	60	50

### 5.6.2 Test Setup

See section 4.4.2 for test setup description for the AC power supply port. The photo of test setup please refer to ANNEX B.

### 5.6.3 Test Procedure

The maximum conducted interference is searched using Peak (PK), if the emission levels more than the AV and QP limits, and that have narrow margins from the AV and QP limits will be re-measured with AV and QP detectors. Tests for both L phase and N phase lines of the power mains connected to the EUT are performed. Refer to recorded points and plots below.

Devices subject to Part 15 must be tested for all available U.S. voltages and frequencies (such as a nominal 120 VAC, 50/60 Hz and 240 VAC, 50/60 Hz) for which the device is capable of operation. A device rated for 50/60 Hz operation need not be tested at both frequencies provided the radiated and line conducted emissions are the same at both frequencies.

### 5.6.4 Test Result

Please refer to ANNEX A.5.



## 5.7 Radiated Spurious Emission

### 5.7.1 Limit

FCC §15.209&15.247(d); RSS-GEN, 8.9; RSS-247, 5.5

Radiated emission outside the frequency band attenuation below the general limits specified in FCC section 15.209(a) is not required. In addition, radiated emissions which fall in the restricted bands, as defined in FCC section 15.205(a), must also comply with the radiated emission limits specified in FCC section 15.209(a).

According to FCC section 15.209 (a), except as provided elsewhere in this subpart, the emissions from an intentional radiator shall not exceed the field strength levels specified in the following table:

Frequency (MHz)	Field Strength (µV/m)	Measurement Distance (m)
0.009 - 0.490	2400/F(kHz)	300
0.490 - 1.705	24000/F(kHz)	30
1.705 - 30.0	30	30
30 - 88	100	3
88 - 216	150	3
216 - 960	200	3
Above 960	500	3

Note:

1. Field Strength (dBµV/m) = 20\*log[Field Strength (µV/m)].
2. In the emission tables above, the tighter limit applies at the band edges.
3. For Above 1000 MHz, the emission limit in this paragraph is based on measurement instrumentation employing an average detector, measurement using instrumentation with a peak detector function, corresponding to 20dB above the maximum permitted average limit.
4. For above 1000 MHz, limit field strength of harmonics: 54dBuV/m@3m (AV) and 74dBuV/m@3m (PK).

### 5.7.2 Test Setup

See section 4.4.3 to 4.4.5 for test setup description for the antenna port. The photo of test setup please refer to ANNEX B.

### 5.7.3 Test Procedure

Since the emission limits are specified in terms of radiated field strength levels, measurements performed to demonstrate compliance have traditionally relied on a radiated test configuration. Radiated measurements remain the principal method for demonstrating compliance to the specified limits; however antenna-port conducted measurements are also now acceptable to demonstrate compliance (see below for details). When radiated measurements are utilized, test site requirements and procedures for maximizing and measuring radiated emissions that are described in ANSI C63.10 shall be followed.

Antenna-port conducted measurements may also be used as an alternative to radiated measurements for demonstrating compliance in the restricted frequency bands. If conducted measurements are performed, then proper impedance matching must be ensured and an additional radiated test for cabinet/case spurious emissions is required.

General Procedure for conducted measurements in restricted bands:

- a) Measure the conducted output power (in dBm) using the detector specified (see guidance regarding measurement procedures for determining quasi-peak, peak, and average conducted output power, respectively).
- b) Add the maximum transmit antenna gain (in dBi) to the measured output power level to determine the EIRP level (see guidance on determining the applicable antenna gain)
- c) Add the appropriate maximum ground reflection factor to the EIRP level (6 dB for frequencies  $\leq 30$  MHz, 4.7 dB for frequencies between 30 MHz and 1000 MHz, inclusive and 0 dB for frequencies  $> 1000$  MHz).
- d) For devices with multiple antenna-ports, measure the power of each individual chain and sum the EIRP of all chains in linear terms (e.g., Watts, mW).
- e) Convert the resultant EIRP level to an equivalent electric field strength using the following relationship:

$$E = \text{EIRP} - 20\log D + 104.8$$

where:

E = electric field strength in dB $\mu$ V/m,

EIRP = equivalent isotropic radiated power in dBm

D = specified measurement distance in meters.

- f) Compare the resultant electric field strength level to the applicable limit.
- g) Perform radiated spurious emission test.

#### Quasi-Peak measurement procedure

The specifications for measurements using the CISPR quasi-peak detector can be found in Publication 16 of the International Special Committee on Radio Frequency Interference (CISPR) of the International Electrotechnical Commission.

As an alternative to CISPR quasi-peak measurement, compliance can be demonstrated to the applicable emission limits using a peak detector.

Peak power measurement procedure:

Peak emission levels are measured by setting the instrument as follows:

- a) RBW = as specified in Table 1.
- b) VBW  $\geq 3 \times$  RBW.
- c) Detector = Peak.
- d) Sweep time = auto.
- e) Trace mode = max hold.
- f) Allow sweeps to continue until the trace stabilizes. (Note that the required measurement time may be longer for low duty cycle applications).

Table 1—RBW as a function of frequency

Frequency	RBW
9-150 kHz	200-300 Hz
0.15-30 MHz	9-10 kHz
30-1000 MHz	100-120 kHz
> 1000 MHz	1 MHz

If the peak-detected amplitude can be shown to comply with the average limit, then it is not necessary to perform a separate average measurement.

Trace averaging across on and off times of the EUT transmissions followed by duty cycle correction:

If continuous transmission of the EUT (i.e., duty cycle  $\geq$  98 percent) cannot be achieved and the duty cycle is constant (i.e., duty cycle variations are less than  $\pm$  2 percent), then the following procedure shall be used:

- a) The EUT shall be configured to operate at the maximum achievable duty cycle.
- b) Measure the duty cycle, x, of the transmitter output signal as described in section 6.0.
- c) RBW = 1 MHz (unless otherwise specified).
- d) VBW  $\geq$  3 x RBW.
- e) Detector = RMS, if span/(# of points in sweep)  $\leq$  (RBW/2). Satisfying this condition may require increasing the number of points in the sweep or reducing the span. If this condition cannot be satisfied, then the detector mode shall be set to peak.
- f) Averaging type = power (i.e., RMS).
  - 1) As an alternative, the detector and averaging type may be set for linear voltage averaging.
  - 2) Some instruments require linear display mode in order to use linear voltage averaging. Log or dB averaging shall not be used.
- g) Sweep time = auto.
- h) Perform a trace average of at least 100 traces.
- i) A correction factor shall be added to the measurement results prior to comparing to the emission limit in order to compute the emission level that would have been measured had the test been performed at 100 percent duty cycle. The correction factor is computed as follows:
  - 1) If power averaging (RMS) mode was used in step f), then the applicable correction factor is  $10 \log(1/x)$ , where x is the duty cycle.
  - 2) If linear voltage averaging mode was used in step f), then the applicable correction factor is  $20 \log(1/x)$ , where x is the duty cycle.
  - 3) If a specific emission is demonstrated to be continuous ( $\geq$  98 percent duty cycle) rather than turning on and off with the transmit cycle, then no duty cycle correction is required for that emission.

NOTE: Reduction of the measured emission amplitude levels to account for operational duty factor is not permitted. Compliance is based on emission levels occurring during transmission - not on an average across on and off times of the transmitter.

Determining the applicable transmit antenna gain:

A conducted power measurement will determine the maximum output power associated with a restricted band emission; however, in order to determine the associated EIRP level, the gain of the transmitting antenna (in dBi) must be added to the measured output power (in dBm).

Since the out-of-band characteristics of the EUT transmit antenna will often be unknown, the use of a conservative antenna gain value is necessary. Thus, when determining the EIRP based on the measured conducted power, the upper bound on antenna gain for a device with a single RF output shall be selected as the maximum in-band gain of the antenna across all operating bands, or 2 dBi, whichever is greater. However, for devices that operate in multiple frequency bands while using the same transmit antenna, the highest gain of the antenna within the operating band nearest in frequency to the restricted band emission being measured may be used in lieu of the overall highest gain when the emission is at a frequency that is within 20 percent of the nearest band edge frequency, but in no case shall a value less than 2 dBi be used.

See KDB 662911 for guidance on calculating the additional array gain term when determining the effective antenna gain for a EUT with multiple outputs occupying the same or overlapping frequency ranges in the same band.

Radiated spurious emission test:

An additional consideration when performing conducted measurements of restricted band emissions is that unwanted emissions radiating from the EUT cabinet, control circuits, power leads, or intermediate circuit elements will likely go undetected in a conducted measurement configuration. To address this concern, a radiated test shall be performed to ensure that emissions emanating from the EUT cabinet (rather than the antenna port) also comply with the applicable limits.

For these cabinet radiated spurious emission measurements the EUT transmit antenna may be replaced with a termination matching the nominal impedance of the antenna. Procedures for performing radiated measurements are specified in ANSI C63.10. All detected emissions shall comply with the applicable limits.

The measurement frequency range is from 30MHz to the 10th harmonic of the fundamental frequency. The Turn Table is actuated to turn from 0° to 360°, and both horizontal and vertical polarizations of the Test Antenna are used to find the maximum radiated power. Mid channels on all channel bandwidth verified. Only the worst RB size/offset presented.

The power of the EUT transmitting frequency should be ignored.

All Spurious Emission tests were performed in X, Y, Z axis direction. And only the worst axis test condition was recorded in this test report.

Use the following spectrum analyzer settings:

Span = wide enough to fully capture the emission being measured

RBW = 1 MHz for  $f \geq 1$  GHz, 100 kHz for  $f < 1$  GHz

VBW  $\geq$  RBW

Sweep = auto

Detector function = peak

Trace = max hold

#### 5.7.4 Test Result

Please refer to ANNEX A.6.

## 5.8 Band Edge (Restricted-band band-edge)

### 5.8.1 Limit

FCC §15.209&15.247(d); RSS-GEN, 8.9; RSS-247, 5.5

Radiated emission outside the frequency band attenuation below the general limits specified in FCC section 15.209(a) is not required. In addition, radiated emissions which fall in the restricted bands, as defined in FCC section 15.205(a), must also comply with the radiated emission limits specified in FCC section 15.209(a).

### 5.8.2 Test Setup

See section 4.4.3 to 4.4.5 for test setup description for the antenna port. The photo of test setup please refer to ANNEX B.

### 5.8.3 Test Procedure

The measurement frequency range is from 9 kHz to the 10th harmonic of the fundamental frequency. The Turn Table is actuated to turn from 0° to 360°, and both horizontal and vertical polarizations of the Test Antenna are used to find the maximum radiated power. Mid channels on all channel bandwidth verified. Only the worst RB size/offset presented.

The power of the EUT transmitting frequency should be ignored.

All Spurious Emission tests were performed in X, Y, Z axis direction. And only the worst axis test condition was recorded in this test report.

Use the following spectrum analyzer settings:

Span = wide enough to fully capture the emission being measured

RBW = 1 MHz for  $f \geq 1$  GHz, 100 kHz for  $f < 1$  GHz

VBW  $\geq$  RBW

Sweep = auto

Detector function = peak

Trace = max hold

For measurement below 1GHz, If the emission level of the EUT measured by the peak detector is 3 dB lower than the applicable limit, the peak emission level will be reported, Otherwise, the emission measurement will be repeated using the quasi-peak detector and reported.

For transmitters operating above 1 GHz repeat the measurement with an average detector.

### 1.1.1 Test Result

Please refer to ANNEX A.7.

## 5.9 Power Spectral density (PSD)

### 5.9.1 Limit

FCC §15.247(e); RSS-247, 5.2 (2)

The same method of determining the conducted output power shall be used to determine the power spectral density. If a peak output power is measured, then a peak power spectral density measurement is required. If an average output power is measured, then an average power spectral density measurement should be used.

The transmitter power spectral density conducted from the transmitter to the antenna shall not be greater than 8 dBm in any 3 kHz band during any time interval of continuous transmission. This power spectral density shall be determined in accordance with the provisions of Section 5.4(4), (i.e. the power spectral density shall be determined using the same method as is used to determine the conducted output power).

### 5.9.2 Test Setup

See section 4.4.1 (Diagram 1) for test setup description for the antenna port. The photo of test setup please refer to ANNEX B.

### 5.9.3 Test Procedure

Set analyzer center frequency to DTS channel center frequency.

Set the span to 1.5 times the DTS bandwidth.

Set the RBW to:  $3 \text{ kHz} \leq \text{RBW} \leq 100 \text{ kHz}$ .

Set the VBW  $\geq 3 \text{ RBW}$ .

Detector = peak.

Sweep time = auto couple.

Trace mode = max hold.

Allow trace to fully stabilize.

Use the peak marker function to determine the maximum amplitude level within the RBW.

If measured value exceeds limit, reduce RBW (no less than 3 kHz) and repeat.

### 5.9.4 Test Result

Please refer to ANNEX A.7.

# ANNEX A TEST RESULT

## A.1 Output Power, E.I.R.P, Duty Cycle

### Peak Power Test Data

Channel	Measured Output Peak Power		Limit		Verdict
	GFSK(BLE)		dBm	mW	
	dBm	mW			
Low	3.56	2.27	30	1000	Pass
Middle	3.10	2.04			Pass
High	2.42	1.75			Pass

### E.I.R.P Test Data (For ISED)

Channel	E.I.R.P		Limit		Verdict
	GFSK(BLE)		dBm	mW	
	dBm	mW			
Low	5.17	3.29	36	4000	Pass
Middle	4.71	2.96			Pass
High	4.03	2.53			Pass

### Test plots

GFSK(BLE) LOW CHANNEL

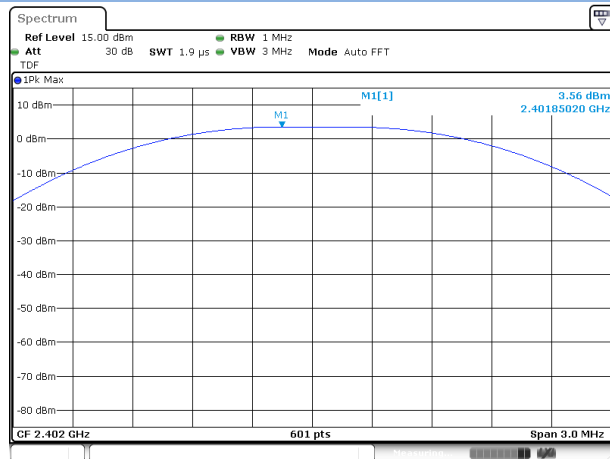

Date: 14.DEC.2018 13:41:11

GFSK(BLE) MIDDLE CHANNEL

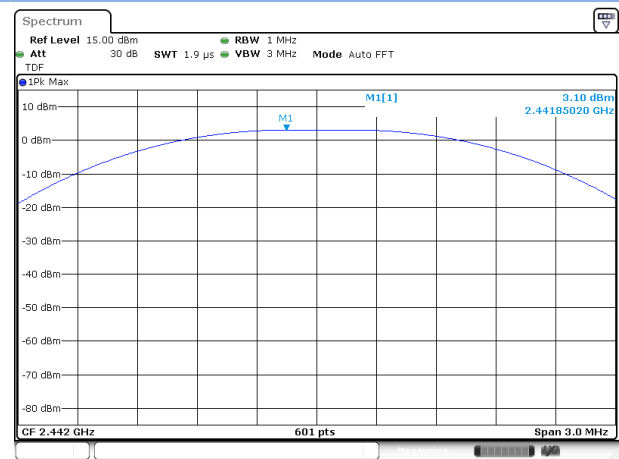

Date: 14.DEC.2018 13:43:36

### GFSK(BLE) HIGH CHANNEL

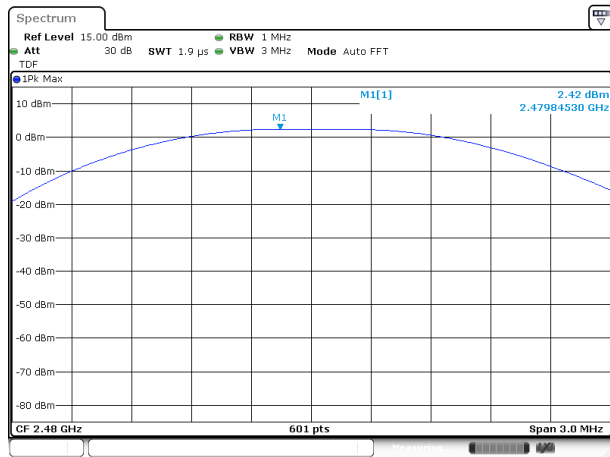

Date: 14.DEC.2018 13:42:51



## A.2 Occupied Bandwidth

Note: Occupied Bandwidth result reference from original BLE module FCC report: ER/2016/70009 (FCC ID: SH6MDBT42Q) (issued by SGS Taiwan Ltd. On Jul. 22, 2016) 8. 6dB BANDWIDTH MEASUREMENT and BLE module IC report: ER/2016/70011 (IC ID: 8017A-MDBT42Q) (issued by SGS Taiwan Ltd. On Jul. 22, 2016) 8. 6dB & 99% BANDWIDTH MEASUREMENT

## A.3 Conducted Spurious Emissions

Note: Conducted Spurious Emissions result reference from original BLE module FCC report: ER/2016/70009 (FCC ID: SH6MDBT42Q) (issued by SGS Taiwan Ltd. On Jul. 22, 2016) 9. CONDUCTED BAND EDGES AND SPURIOUS EMISSION MEASUREMENT and BLE module IC report: ER/2016/70011 (IC ID: 8017A-MDBT42Q) (issued by SGS Taiwan Ltd. On Jul. 22, 2016) 9. CONDUCTED BAND EDGES AND SPURIOUS EMISSION MEASUREMENT

## A.4 Band Edge (Authorized-band band-edge)

Note: Band Edge (Authorized-band band-edge) result reference from original BLE module FCC report: ER/2016/70009 (FCC ID: SH6MDBT42Q) (issued by SGS Taiwan Ltd. On Jul. 22, 2016) 9. CONDUCTED BAND EDGES AND SPURIOUS EMISSION MEASUREMENT and BLE module IC report: ER/2016/70011 (IC ID: 8017A-MDBT42Q) (issued by SGS Taiwan Ltd. On Jul. 22, 2016) 9. CONDUCTED BAND EDGES AND SPURIOUS EMISSION MEASUREMENT

## A.5 Conducted Emissions

Note 1: The EUT is working in the Normal link mode.

Note 2: Devices subject to Part 15 must be tested for all available U.S. voltages and frequencies (such as a nominal 120 VAC, 60 Hz and 240 VAC, 50 Hz) for which the device is capable of operation. So, The configuration 120 VAC, 60 Hz and 240 VAC, 50 Hz were tested respectively, but only the worst configuration (120 VAC, 60 Hz ) shown here.

Note 3: Results (dBuV) = Original reading level of Spectrum Analyzer (dBuV) + Factor (dB)

### Test Data and Plots

#### PHASE L

CE Test case\_FCC\_CE\_FCC PART 15B\_ Class B

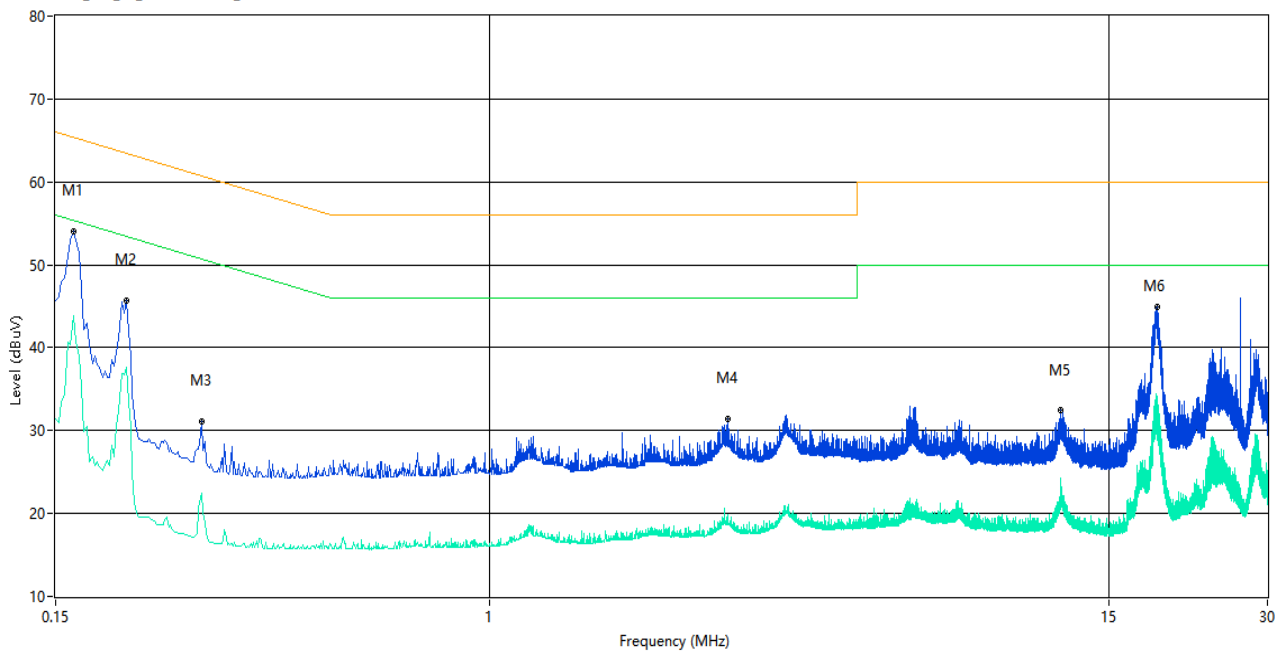

No.	Frequency (MHz)	Results (dBuV)	Factor (dB)	Limit (dBuV)	Over Limit (dB)	Detector	Line	Verdict
1	0.156	48.5	10.01	65.7	-17.20	Peak	L Line	Pass
1**	0.156	34.3	10.01	55.7	-21.40	AV	L Line	Pass
2	0.204	45.7	10.01	63.4	-17.70	Peak	L Line	Pass
2**	0.204	37.7	10.01	53.4	-15.70	AV	L Line	Pass
3	0.284	31.1	10.03	60.7	-29.60	Peak	L Line	Pass
3**	0.284	22.4	10.03	50.7	-28.30	AV	L Line	Pass
4	2.828	31.4	10.09	56.0	-24.60	Peak	L Line	Pass
4**	2.828	19.9	10.09	46.0	-26.10	AV	L Line	Pass
5	12.130	32.4	10.19	60.0	-27.60	Peak	L Line	Pass
5**	12.130	22.4	10.19	50.0	-27.60	AV	L Line	Pass
6	18.578	44.9	10.23	60.0	-15.10	Peak	L Line	Pass
6**	18.578	32.2	10.23	50.0	-17.80	AV	L Line	Pass

## PHASE N

CE Test case\_FCC\_CE\_FCC PART 15B\_Class B

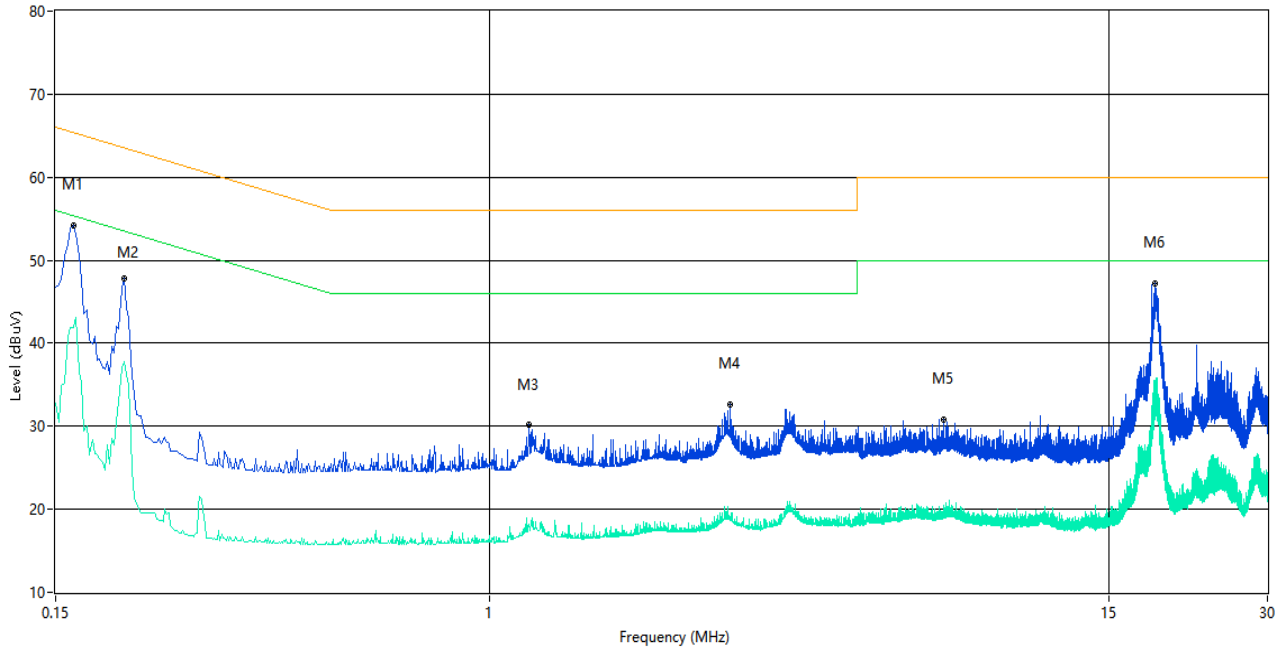

No.	Frequency (MHz)	Results (dBuV)	Factor (dB)	Limit (dBuV)	Over Limit (dB)	Detector	Line	Verdict
1	0.162	54.2	10.01	65.4	-11.20	Peak	N Line	Pass
1**	0.162	41.9	10.01	55.4	-13.50	AV	N Line	Pass
2	0.202	47.8	10.01	63.5	-15.70	Peak	N Line	Pass
2**	0.202	37.8	10.01	53.5	-15.70	AV	N Line	Pass
3	1.190	30.1	10.04	56.0	-25.90	Peak	N Line	Pass
3**	1.190	17.8	10.04	46.0	-28.20	AV	N Line	Pass
4	2.858	32.7	10.08	56.0	-23.30	Peak	N Line	Pass
4**	2.858	18.8	10.08	46.0	-27.20	AV	N Line	Pass
5	7.286	30.8	10.14	60.0	-29.20	Peak	N Line	Pass
5**	7.286	20.0	10.14	50.0	-30.00	AV	N Line	Pass
6	18.316	47.2	10.24	60.0	-12.80	Peak	N Line	Pass
6**	18.316	35.0	10.24	50.0	-15.00	AV	N Line	Pass

## A.6 Radiated Spurious Emission

Note 1: The symbol of “--” in the table which means not application.

Note 2: For the test data above 1 GHz, according the ANSI C63.4-2014, where limits are specified for both average and peak (or quasi-peak) detector functions, if the peak (or quasi-peak) measured value complies with the average limit, it is unnecessary to perform an average measurement.

Note 3: The low frequency, which started from 9 kHz to 30 MHz, was pre-scanned and the result which was 20 dB lower than the limit line per 15.31(o) was not reported.

Note 4: The EUT is working in the Normal link mode below 1 GHz.

Note 5: Results (dBuV/m) = Original reading level of Spectrum Analyzer (dBuV/m) + Factor (dB)

### Test Data and Plots

#### 30 MHz to 1 GHz, ANT V

RE Test case FCC\_Part 15C\_FCC 15.247(2.4G)\_30MHz-1GHz

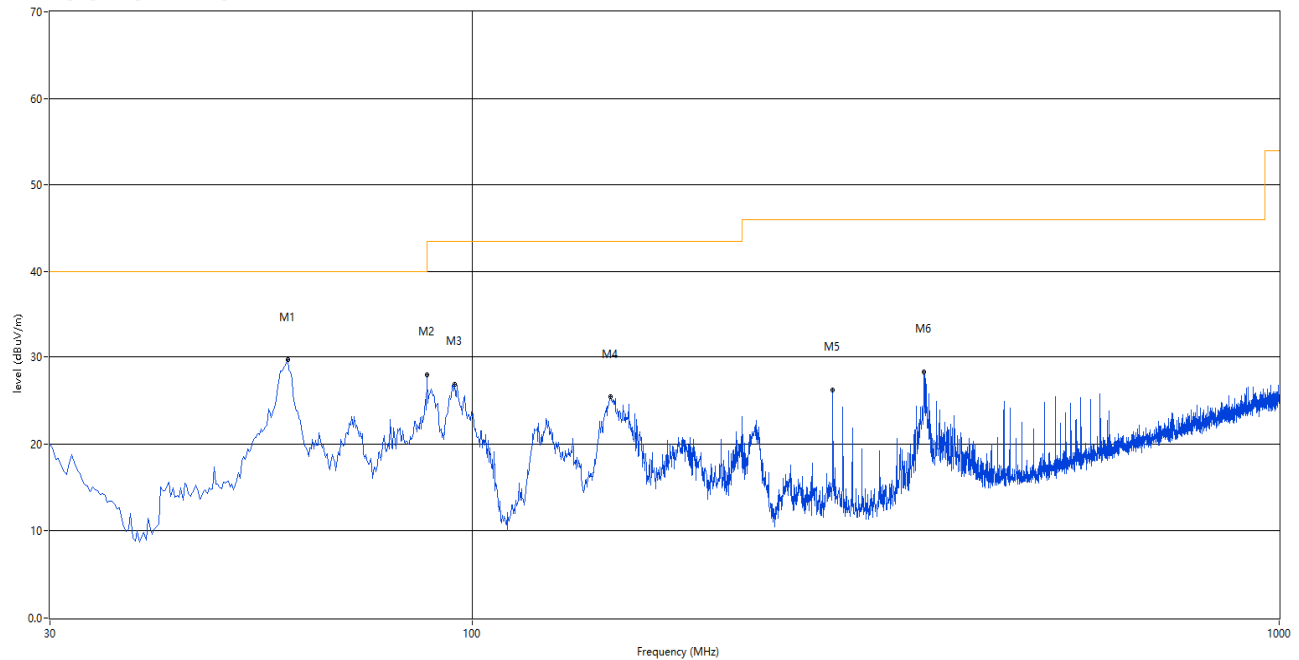

No.	Frequency (MHz)	Results (dBuV/m)	Factor (dB)	Limit (dBuV/m)	Over Limit (dB)	Detector	Table (o)	Height (cm)	ANT	Verdict
1	59.100	29.68	-27.47	40.0	-10.32	Peak	157.00	100	Vertical	Pass
2	87.957	27.95	-30.40	40.0	-12.05	Peak	78.00	100	Vertical	Pass
3	95.232	26.91	-30.19	43.5	-16.59	Peak	83.00	100	Vertical	Pass
4	148.340	25.41	-25.32	43.5	-18.09	Peak	360.00	200	Vertical	Pass
5	280.017	26.22	-25.03	46.0	-19.78	Peak	212.00	200	Vertical	Pass
6	363.195	28.33	-22.75	46.0	-17.67	Peak	24.00	200	Vertical	Pass

30 MHz to 1 GHz, ANT H

RE Test case\_FCC\_Part 15C\_FCC 15.247(2.4G)\_30MHz-1GHz

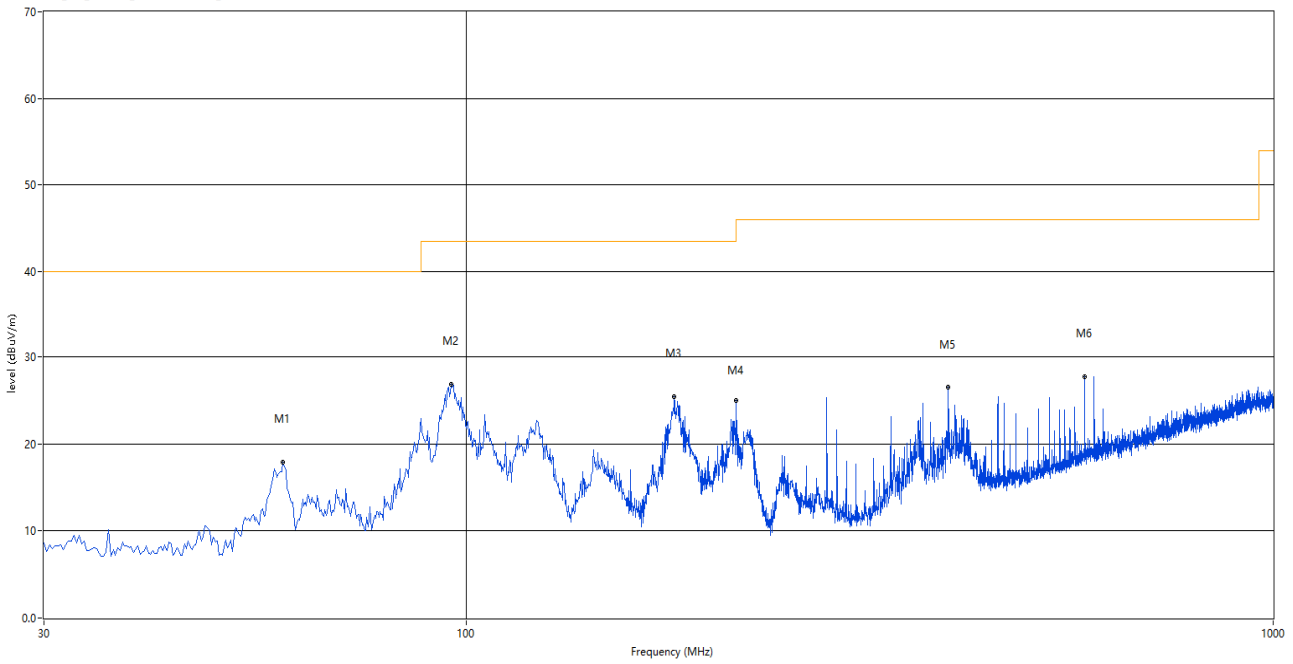

No.	Frequency (MHz)	Results (dBuV/m)	Factor (dB)	Limit (dBuV/m)	Over Limit (dB)	Detector	Table (o)	Height (cm)	ANT	Verdict
1	59.343	17.93	-27.48	40.0	-22.07	Peak	80.00	100	Horizontal	Pass
2	95.960	26.89	-30.16	43.5	-16.61	Peak	0.00	200	Horizontal	Pass
3	181.078	25.42	-27.37	43.5	-18.08	Peak	6.00	100	Horizontal	Pass
4	215.998	25.02	-28.11	43.5	-18.48	Peak	157.00	100	Horizontal	Pass
5	395.932	26.48	-21.70	46.0	-19.52	Peak	0.00	200	Horizontal	Pass
6	584.113	27.79	-16.79	46.0	-18.21	Peak	250.00	200	Horizontal	Pass

Note 1: The marked spikes near 2400 MHz with circle should be ignored because they are Fundamental signal.

Note 2: The spurious from 18GHz-25GHz is noise only, do not show on the report.

GFSK LOW CHANNEL 1 GHz to 18 GHz, ANT V

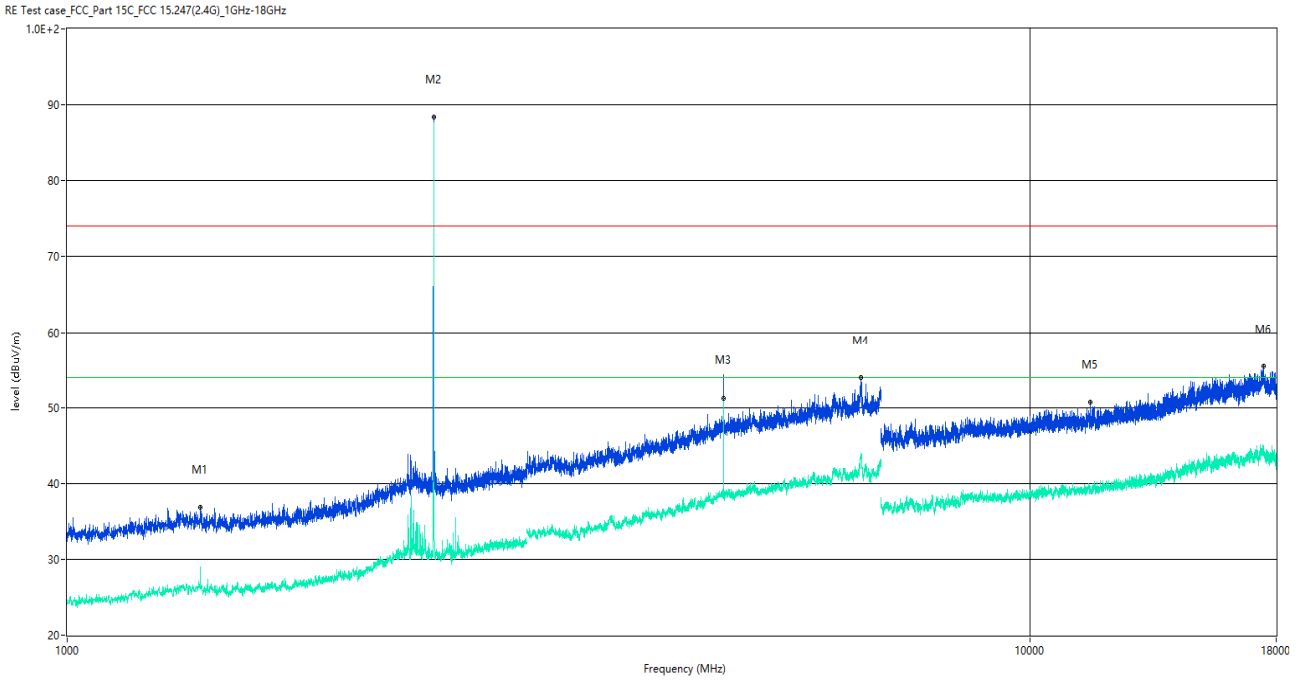

No.	Frequency (MHz)	Results (dBuV/m)	Factor (dB)	Limit (dBuV/m)	Over Limit (dB)	Detector	Table (o)	Height (cm)	ANT	Verdict
1**	1376.000	26.98	-17.47	54.0	-27.02	AV	304.00	150	Vertical	Pass
1	1376.000	36.85	-17.47	74.0	-37.15	Peak	304.00	150	Vertical	Pass
2**	2402.000	82.95	-12.20	54.0	28.95	AV	173.00	150	Vertical	N/A
2	2402.000	88.39	-12.20	74.0	14.39	Peak	173.00	150	Vertical	N/A
3**	4805.000	50.89	-2.85	54.0	-3.11	AV	122.00	150	Vertical	Pass
3	4805.000	53.25	-2.85	74.0	-20.75	Peak	122.00	150	Vertical	Pass
4**	6675.000	43.68	1.88	54.0	-10.32	AV	202.00	150	Vertical	Pass
4	6675.000	53.94	1.88	74.0	-20.06	Peak	202.00	150	Vertical	Pass
5**	11539.625	38.96	-0.28	54.0	-15.04	AV	226.00	150	Vertical	Pass
5	11539.625	50.64	-0.28	74.0	-23.36	Peak	226.00	150	Vertical	Pass
6**	17476.313	44.82	3.55	54.0	-9.18	AV	43.00	150	Vertical	Pass
6	17476.313	55.40	3.55	74.0	-18.60	Peak	43.00	150	Vertical	Pass

GFSK LOW CHANNEL 1 GHz to 18 GHz, ANT H

RE Test case\_FCC\_Part 15C\_FCC 15.247(2.4G)\_1GHz-18GHz

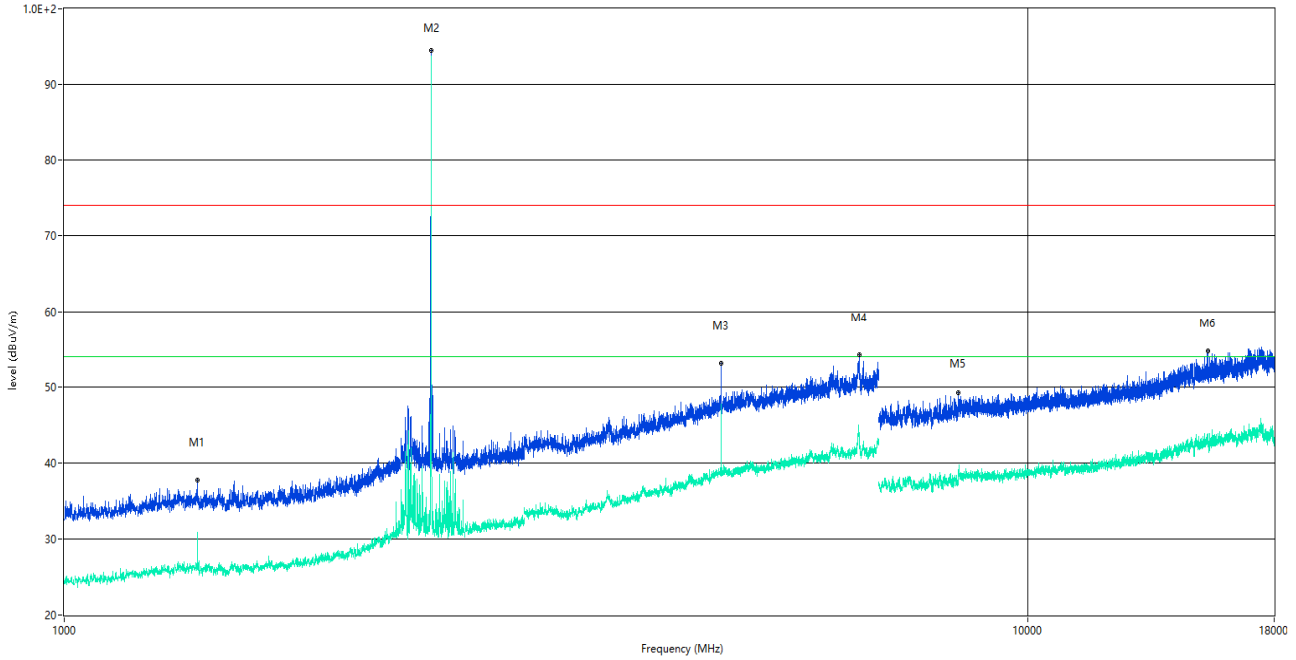

No.	Frequency (MHz)	Results (dBuV/m)	Factor (dB)	Limit (dBuV/m)	Over Limit (dB)	Detector	Table (o)	Height (cm)	ANT	Verdict
1**	1375.000	27.66	-17.47	54.0	-26.34	AV	160.00	150	Horizontal	Pass
1	1375.000	37.67	-17.47	74.0	-36.33	Peak	160.00	150	Horizontal	Pass
2**	2402.000	90.89	-12.20	54.0	36.89	AV	212.00	150	Horizontal	N/A
2	2402.000	94.46	-12.20	74.0	20.46	Peak	212.00	150	Horizontal	N/A
3**	4804.000	41.09	-2.88	54.0	-12.91	AV	125.00	150	Horizontal	Pass
3	4804.000	53.06	-2.88	74.0	-20.94	Peak	125.00	150	Horizontal	Pass
4**	6678.000	43.68	1.62	54.0	-10.32	AV	0.00	150	Horizontal	Pass
4	6678.000	54.24	1.62	74.0	-19.76	Peak	0.00	150	Horizontal	Pass
5**	8459.062	37.60	-1.16	54.0	-16.40	AV	311.00	150	Horizontal	Pass
5	8459.062	49.19	-1.16	74.0	-24.81	Peak	311.00	150	Horizontal	Pass
6**	15359.250	43.07	1.44	54.0	-10.93	AV	171.00	150	Horizontal	Pass
6	15359.250	54.73	1.44	74.0	-19.27	Peak	171.00	150	Horizontal	Pass

GFSK MIDDLE CHANNEL 1 GHz to 18 GHz, ANT V

RE Test case\_FCC\_Part 15C\_FCC 15.247(2.4G)\_1GHz-18GHz

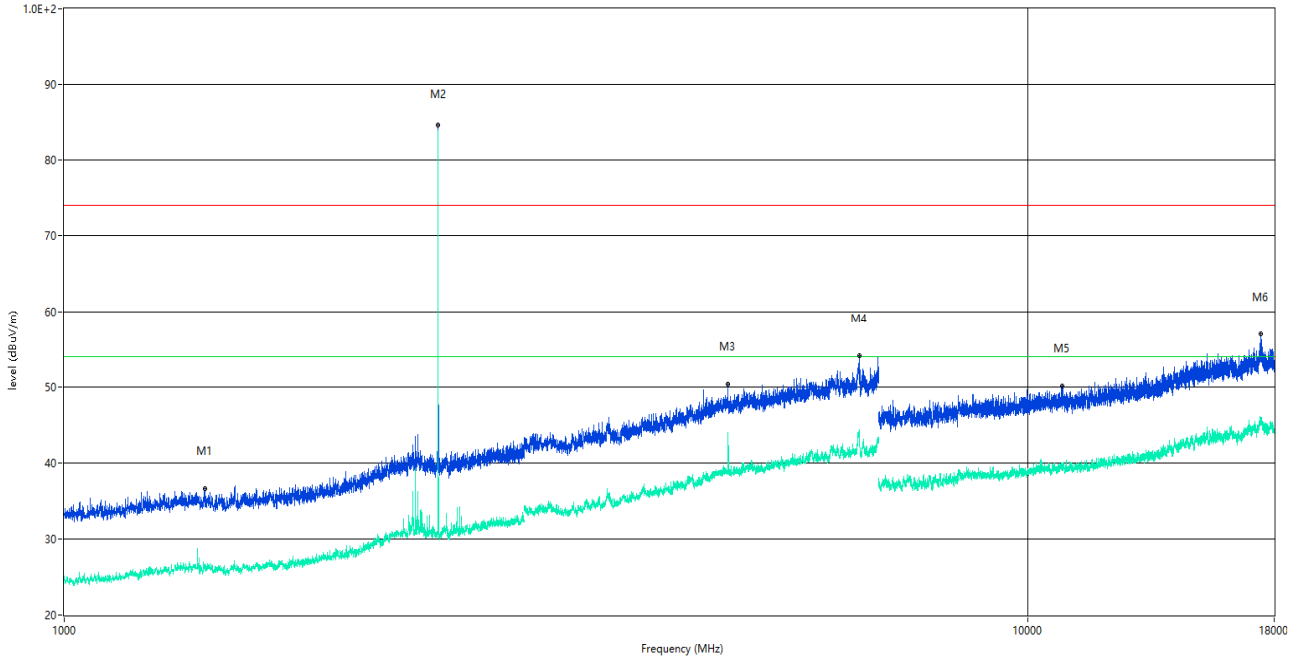

No.	Frequency (MHz)	Results (dBuV/m)	Factor (dB)	Limit (dBuV/m)	Over Limit (dB)	Detector	Table (o)	Height (cm)	ANT	Verdict
1**	1399.500	25.86	-17.37	54.0	-28.14	AV	360.00	150	Vertical	Pass
1	1399.500	36.55	-17.37	74.0	-37.45	Peak	360.00	150	Vertical	Pass
2**	2442.000	80.28	-12.97	54.0	26.28	AV	171.00	150	Vertical	N/A
2	2442.000	84.62	-12.97	74.0	10.62	Peak	171.00	150	Vertical	N/A
3**	4884.000	40.32	-2.63	54.0	-13.68	AV	314.00	150	Vertical	Pass
3	4884.000	50.35	-2.63	74.0	-23.65	Peak	314.00	150	Vertical	Pass
4**	6681.000	43.92	1.49	54.0	-10.08	AV	292.00	150	Vertical	Pass
4	6681.000	54.05	1.49	74.0	-19.95	Peak	292.00	150	Vertical	Pass
5**	10845.312	39.43	0.93	54.0	-14.57	AV	18.00	150	Vertical	Pass
5	10845.312	50.13	0.93	74.0	-23.87	Peak	18.00	150	Vertical	Pass
6**	17440.874	45.36	4.10	54.0	-8.64	AV	271.00	150	Vertical	Pass
6	17440.874	56.95	4.10	74.0	-17.05	Peak	271.00	150	Vertical	Pass



GFSK MIDDLE CHANNEL 1 GHz to 18 GHz, ANT H

RE Test case\_FCC\_Part 15C\_FCC 15.247(2.4G)\_1GHz-18GHz

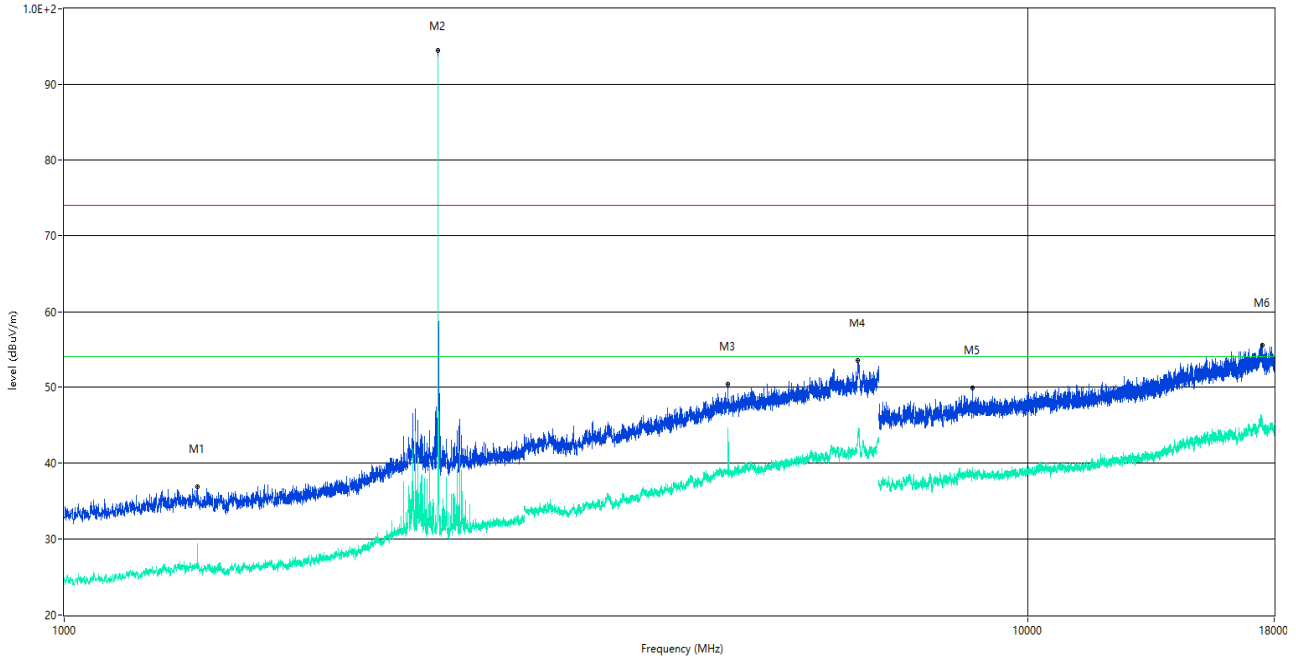

No.	Frequency (MHz)	Results (dBuV/m)	Factor (dB)	Limit (dBuV/m)	Over Limit (dB)	Detector	Table (o)	Height (cm)	ANT	Verdict
1**	1375.000	27.14	-17.47	54.0	-26.86	AV	360.00	150	Horizontal	Pass
1	1375.000	36.87	-17.47	74.0	-37.13	Peak	360.00	150	Horizontal	Pass
2**	2442.000	90.16	-12.97	54.0	36.16	AV	201.00	150	Horizontal	N/A
2	2442.000	94.56	-12.97	74.0	20.56	Peak	201.00	150	Horizontal	N/A
3**	4884.000	39.46	-2.63	54.0	-14.54	AV	124.00	150	Horizontal	Pass
3	4884.000	50.33	-2.63	74.0	-23.67	Peak	124.00	150	Horizontal	Pass
4**	6659.000	43.43	1.49	54.0	-10.57	AV	0.00	150	Horizontal	Pass
4	6659.000	53.40	1.49	74.0	-20.60	Peak	0.00	150	Horizontal	Pass
5**	8758.062	38.35	-0.86	54.0	-15.65	AV	109.00	150	Horizontal	Pass
5	8758.062	49.85	-0.86	74.0	-24.15	Peak	109.00	150	Horizontal	Pass
6**	17507.813	44.64	3.04	54.0	-9.36	AV	0.00	150	Horizontal	Pass
6	17507.813	55.50	3.04	74.0	-18.50	Peak	0.00	150	Horizontal	Pass

GFSK HIGH CHANNEL 1 GHz to 18 GHz, ANT V

RE Test case\_FCC\_Part 15C\_FCC 15.247(2.4G)\_1GHz-18GHz

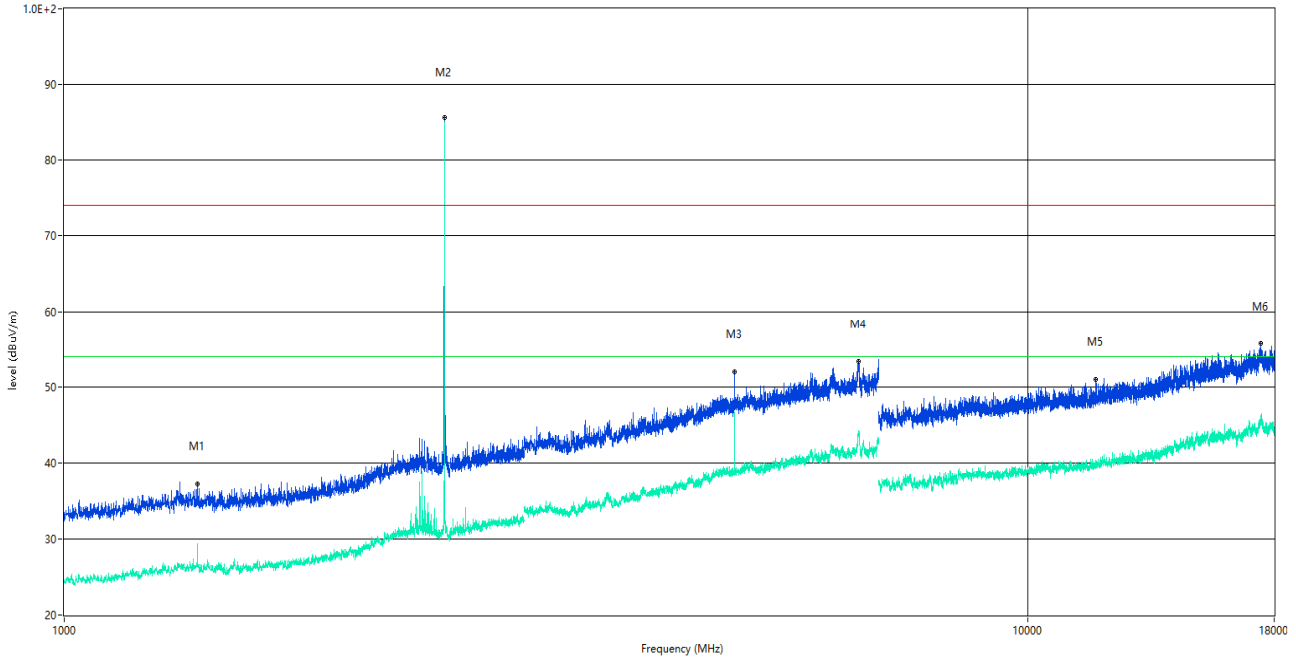

No.	Frequency (MHz)	Results (dBuV/m)	Factor (dB)	Limit (dBuV/m)	Over Limit (dB)	Detector	Table (o)	Height (cm)	ANT	Verdict
1**	1374.500	26.37	-17.39	54.0	-27.63	AV	254.00	150	Vertical	Pass
1	1374.500	37.21	-17.39	74.0	-36.79	Peak	254.00	150	Vertical	Pass
2**	2480.000	80.73	-11.71	54.0	26.73	AV	35.00	150	Vertical	N/A
2	2480.000	85.66	-11.71	74.0	11.66	Peak	35.00	150	Vertical	N/A
3**	4960.000	40.24	-2.64	54.0	-13.76	AV	192.00	150	Vertical	Pass
3	4960.000	51.91	-2.64	74.0	-22.09	Peak	192.00	150	Vertical	Pass
4**	6664.000	43.70	1.64	54.0	-10.30	AV	136.00	150	Vertical	Pass
4	6664.000	53.35	1.64	74.0	-20.65	Peak	136.00	150	Vertical	Pass
5**	11759.563	39.82	1.33	54.0	-14.18	AV	321.00	150	Vertical	Pass
5	11759.563	50.91	1.33	74.0	-23.09	Peak	321.00	150	Vertical	Pass
6**	17435.625	45.32	4.34	54.0	-8.68	AV	170.00	150	Vertical	Pass
6	17435.625	55.72	4.34	74.0	-18.28	Peak	170.00	150	Vertical	Pass

GFSK HIGH CHANNEL 1 GHz to 18 GHz, ANT H

RE Test case\_FCC\_Part 15C\_FCC 15.247(2.4G)\_1GHz-18GHz

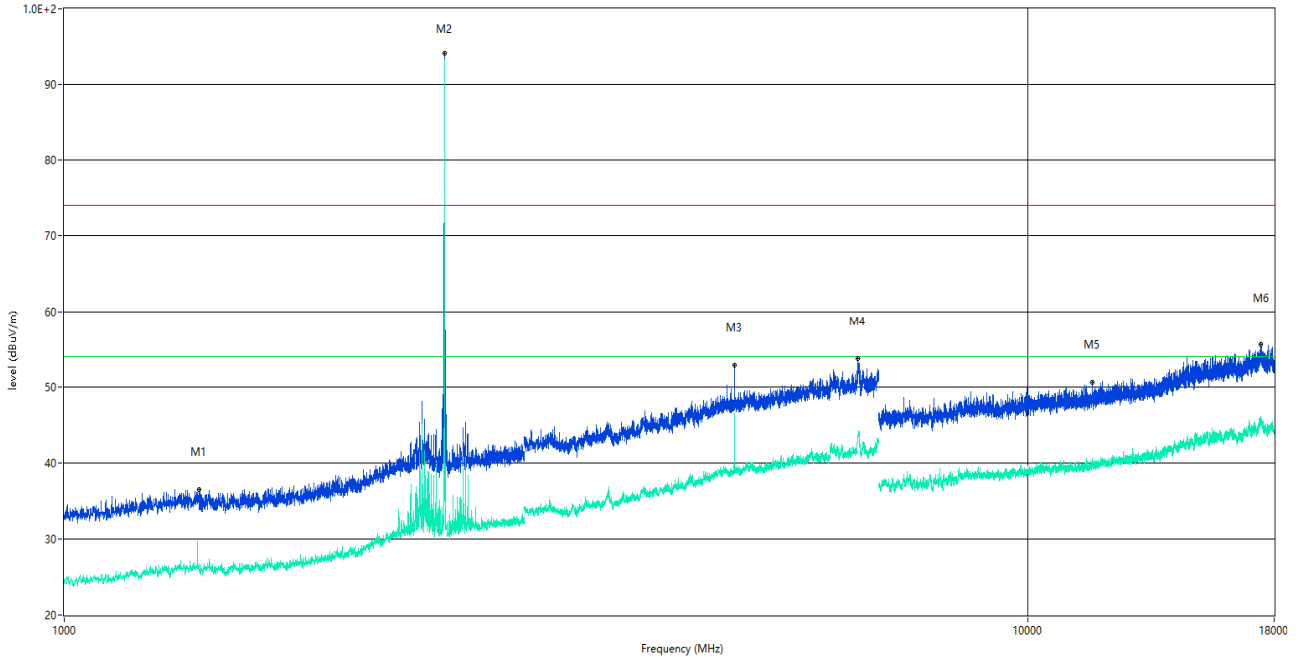

No.	Frequency (MHz)	Results (dBuV/m)	Factor (dB)	Limit (dBuV/m)	Over Limit (dB)	Detector	Table (o)	Height (cm)	ANT	Verdict
1**	1380.000	26.23	-17.17	54.0	-27.77	AV	322.00	150	Horizontal	Pass
1	1380.000	36.43	-17.17	74.0	-37.57	Peak	322.00	150	Horizontal	Pass
2**	2480.000	88.65	-11.71	54.0	34.65	AV	203.00	150	Horizontal	N/A
2	2480.000	94.15	-11.71	74.0	20.15	Peak	203.00	150	Horizontal	N/A
3**	4960.000	41.02	-2.64	54.0	-12.98	AV	354.00	150	Horizontal	Pass
3	4960.000	52.87	-2.64	74.0	-21.13	Peak	354.00	150	Horizontal	Pass
4**	6660.000	43.54	1.54	54.0	-10.46	AV	121.00	150	Horizontal	Pass
4	6660.000	53.68	1.54	74.0	-20.32	Peak	121.00	150	Horizontal	Pass
5**	11663.250	40.06	0.51	54.0	-13.94	AV	208.00	150	Horizontal	Pass
5	11663.250	50.56	0.51	74.0	-23.44	Peak	208.00	150	Horizontal	Pass
6**	17435.625	45.34	4.34	54.0	-8.66	AV	89.00	150	Horizontal	Pass
6	17435.625	55.56	4.34	74.0	-18.44	Peak	89.00	150	Horizontal	Pass

## A.7 Band Edge (Restricted-band band-edge)

Note 1: The lowest and highest channels are tested to verify the band edge emissions. Please refer to the following the plots for emissions values.

Note 2: The test data all are tested in the vertical and horizontal antenna which the trace is max hold. So these plots have shown the worst case.

Note 3: According the ANSI C63.10-2013, where limits are specified for both average and peak (or quasi-peak) detector functions, if the peak (or quasi-peak) measured value complies with the average limit, it is unnecessary to perform an average measurement.

Note 4: The Level (dBuV/m) has been corrected by factor.

Test Mode	Test Channel	Frequency (MHz)	Level (dBuV/m)	Factor (dB)	Limit Line (dBuV/m)	Margin (dB)	Remark	Verdict
GFSK	Low	2390	52.58	31.08	74	21.416	PEAK	Pass
		2390	N/A	N/A	54	N/A	AVERAGE	Pass
GFSK	HIGH	2483.5	60.81	31.09	74	13.189	PEAK	Pass
		2483.5	42.79	31.09	54	11.206	AVERAGE	Pass

### LOW CHANNEL, PEAK

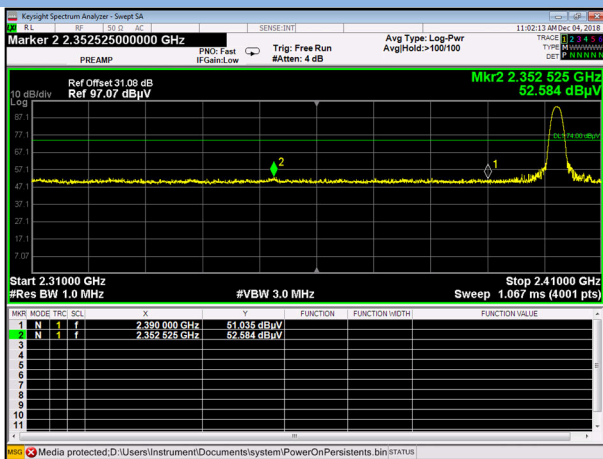

### HIGH CHANNEL, PEAK

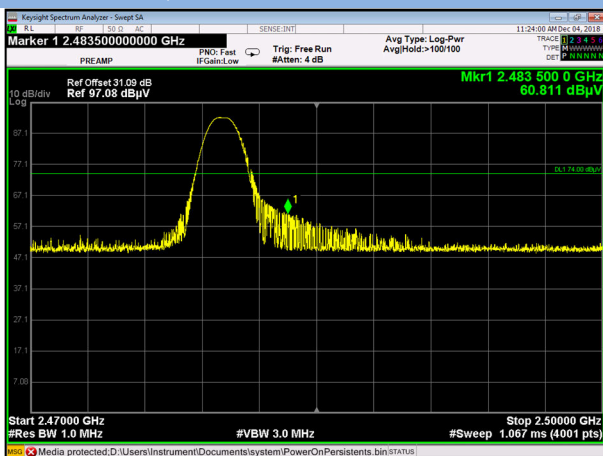

### HIGH CHANNEL, AV



## A.8 Power Spectral Density (PSD)

Note: Power Spectral Density (PSD) result reference from original BLE module FCC report: ER/2016/70009 (FCC ID: SH6MDBT42Q) (issued by SGS Taiwan Ltd. On Jul. 22, 2016) 11. PEAK OUTPUT POWER SPECTRAL DENSITY and BLE module IC report: ER/2016/70011 (IC ID: 8017A-MDBT42Q) (issued by SGS Taiwan Ltd. On Jul. 22, 2016) 11. PEAK OUTPUT POWER SPECTRAL DENSITY

## **ANNEX B TEST SETUP PHOTOS**

Please refer the document "BL-HK18C0003-AR.PDF".

## **ANNEX C EUT EXTERNAL PHOTOS**

Please refer the document "BL-HK18C0003-AW.PDF".

## **ANNEX D EUT INTERNAL PHOTOS**

Please refer the document "BL-HK18C0003-AI.PDF".

--END OF REPORT--