

FCC Test Report

Report No.: RF190918C14-4

FCC ID: 2ARXKVHH10

Test Model: VHH10

Series Model: VHH10XXX (X=A-Z, 0-9, blank or "-")

Received Date: Sep. 18, 2019

Test Date: Oct. 29 ~ Nov. 29, 2019

Issued Date: Dec. 11, 2019

Applicant: Veea Inc

Address: 164 E 83rd Street, New York NY, 10028, USA

Issued By: Bureau Veritas Consumer Products Services (H.K.) Ltd., Taoyuan Branch
Lin Kou Laboratories

Lab Address: No. 47-2, 14th Ling, Chia Pau Vil., Lin Kou Dist., New Taipei City, Taiwan

Test Location: No. 19, Hwa Ya 2nd Rd., Wen Hwa Vil., Kwei Shan Dist., Taoyuan City
33383, TAIWAN

**FCC Registration /
Designation Number:** 788550 / TW0003



This report is for your exclusive use. Any copying or replication of this report to or for any other person or entity, or use of our name or trademark, is permitted only with our prior written permission. This report sets forth our findings solely with respect to the test samples identified herein. The results set forth in this report are not indicative or representative of the quality or characteristics of the lot from which a test sample was taken or any similar or identical product specifically and expressly noted. Our report includes all of the tests requested by you and the results thereof based upon the information that you provided to us. You have 60 days from date of issuance of this report to notify us of any material error or omission caused by our negligence, provided, however, that such notice shall be in writing and shall specifically address the issue you wish to raise. A failure to raise such issue within the prescribed time shall constitute your unqualified acceptance of the completeness of this report, the tests conducted and the correctness of the report contents. Unless specific mention, the uncertainty of measurement has been explicitly taken into account to declare the compliance or non-compliance to the specification. The report must not be used by the client to claim product certification, approval, or endorsement by TAF or any government agencies.

Table of Contents

Release Control Record	4
1 Certificate of Conformity	5
2 Summary of Test Results	6
2.1 Measurement Uncertainty.....	6
2.2 Modification Record.....	6
3 General Information	7
3.1 General Description of EUT.....	7
3.2 Description of Test Modes.....	9
3.2.1 Test Mode Applicability and Tested Channel Detail.....	10
3.3 Duty Cycle of Test Signal.....	12
3.4 Description of Support Units.....	13
3.4.1 Configuration of System under Test.....	13
3.5 General Description of Applied Standards and References.....	13
4 Test Types and Results	15
4.1 Radiated Emission and Bandedge Measurement.....	15
4.1.1 Limits of Radiated Emission and Bandedge Measurement.....	15
4.1.2 Test Instruments.....	16
4.1.3 Test Procedures.....	17
4.1.4 Deviation from Test Standard.....	17
4.1.5 Test Setup.....	18
4.1.6 EUT Operating Conditions.....	19
4.1.7 Test Results.....	20
4.2 Conducted Emission Measurement.....	42
4.2.1 Limits of Conducted Emission Measurement.....	42
4.2.2 Test Instruments.....	42
4.2.3 Test Procedures.....	43
4.2.4 Deviation from Test Standard.....	43
4.2.5 Test Setup.....	43
4.2.6 EUT Operating Conditions.....	43
4.2.7 Test Results.....	44
4.3 Transmit Power Measurement.....	48
4.3.1 Limits of Transmit Power Measurement.....	48
4.3.2 Test Setup.....	48
4.3.3 Test Instruments.....	48
4.3.4 Test Procedure.....	48
4.3.5 Deviation from Test Standard.....	48
4.3.6 EUT Operating Conditions.....	48
4.3.7 Test Result.....	49
4.4 Occupied Bandwidth Measurement.....	53
4.4.1 Test Setup.....	53
4.4.2 Test Instruments.....	53
4.4.3 Test Procedure.....	53
4.4.4 Test Result.....	54
4.5 Peak Power Spectral Density Measurement.....	60
4.5.1 Limits of Peak Power Spectral Density Measurement.....	60
4.5.2 Test Setup.....	60
4.5.3 Test Instruments.....	60
4.5.4 Test Procedures.....	60
4.5.5 Deviation from Test Standard.....	61
4.5.6 EUT Operating Conditions.....	61
4.5.7 Test Results.....	62
4.6 Frequency Stability.....	67
4.6.1 Limits of Frequency Stability Measurement.....	67

4.6.2	Test Setup.....	67
4.6.3	Test Instruments	67
4.6.4	Test Procedure	67
4.6.5	Deviation from Test Standard	68
4.6.6	EUT Operating Condition	68
4.6.7	Test Results	68
4.7	6dB Bandwidth Measurement.....	69
4.7.1	Limits of 6dB Bandwidth Measurement.....	69
4.7.2	Test Setup.....	69
4.7.3	Test Instruments	69
4.7.4	Test Procedure	69
4.7.5	Deviation from Test Standard	69
4.7.6	EUT Operating Condition	69
4.7.7	Test Results	70
5	Pictures of Test Arrangements.....	72
	Annex A- Radiated Out of Band Emission (OOBE) Measurement (For U-NII-3 band).....	73
	Appendix – Information of the Testing Laboratories	76

Release Control Record

Issue No.	Description	Date Issued
RF190918C14-4	Original release	Dec. 11, 2019

1 Certificate of Conformity

Product: veeaHub

Brand: 

Test Model: VHH10

Series Model: VHH10XXX (X=A-Z, 0-9, blank or "-")

Sample Status: Engineering sample

Applicant: Veea Inc

Test Date: Oct. 29 ~ Nov. 29, 2019

Standards: 47 CFR FCC Part 15, Subpart E (Section 15.407)
ANSI C63.10:2013

The above equipment has been tested by **Bureau Veritas Consumer Products Services (H.K.) Ltd., Taoyuan Branch**, and found compliance with the requirement of the above standards. The test record, data evaluation & Equipment Under Test (EUT) configurations represented herein are true and accurate accounts of the measurements of the sample's RF characteristics under the conditions specified in this report.

Prepared by : Celine Chou , **Date:** Dec. 11, 2019
Celine Chou / Senior Specialist

Approved by : Bruce Chen , **Date:** Dec. 11, 2019
Bruce Chen / Senior Project Engineer

2 Summary of Test Results

47 CFR FCC Part 15, Subpart E (Section 15.407)			
FCC Clause	Test Item	Result	Remarks
15.407(b)(6)	AC Power Conducted Emissions	Pass	Meet the requirement of limit. Minimum passing margin is -0.51dB at 0.48600MHz.
15.407(b)(1/2/3/4(i/ii)/6)	Radiated Emissions & Band Edge Measurement	Pass	Meet the requirement of limit. Minimum passing margin is -1.1dB at 17235.00MHz.
15.407(a)(1/2/3)	Max Average Transmit Power	Pass	Meet the requirement of limit.
---	Occupied Bandwidth Measurement	-	Reference only.
15.407(a)(1/2/3)	Peak Power Spectral Density	Pass	Meet the requirement of limit.
15.407(e)	6dB bandwidth	Pass	Meet the requirement of limit. (U-NII-3 Band only)
15.407(g)	Frequency Stability	Pass	Meet the requirement of limit.
15.203	Antenna Requirement	Pass	No antenna connector is used.

Note:

- Determining compliance based on the results of the compliance measurement, not taking into account measurement instrumentation uncertainty.
- For U-NII-3 band compliance with rule part 15.407(b)(4)(i), the OOB test plots were recorded in Annex A.

2.1 Measurement Uncertainty

Where relevant, the following measurement uncertainty levels have been estimated for tests performed on the EUT as specified in CISPR 16-4-2:

Measurement	Frequency	Expanded Uncertainty (k=2) (\pm)
Conducted Emissions at mains ports	150kHz ~ 30MHz	2.79 dB
Radiated Emissions up to 1 GHz	9kHz ~ 30MHz	3.04 dB
	30MHz ~ 200MHz	3.86 dB
	200MHz ~ 1000MHz	3.87 dB
Radiated Emissions above 1 GHz	1GHz ~ 18GHz	2.29 dB
	18GHz ~ 40GHz	2.29 dB

2.2 Modification Record

There were no modifications required for compliance.

3 General Information

3.1 General Description of EUT

Product	veeaHub
Brand	
Test Model	VHH10
Series Model	VHH10XXX (X=A-Z, 0-9, blank or "-")
Model Difference	Marketing purposes
Sample Status	Engineering sample
Power Supply Rating	48Vdc (Adapter and POE)
Modulation Type	256QAM, 64QAM, 16QAM, QPSK, BPSK
Modulation Technology	OFDM
Transfer Rate	802.11a: 54/48/36/24/18/12/9/6Mbps 802.11n: up to 600Mbps 802.11ac: up to 1733.3Mbps
Operating Frequency	5180 ~ 5240MHz, 5745 ~ 5825MHz
Number of Channel	5180 ~ 5240MHz: 802.11a, 802.11n (HT20), 802.11ac (VHT20): 4 802.11n (HT40), 802.11ac (VHT40): 2 802.11ac (VHT80): 1 5745 ~ 5825MHz: 802.11a, 802.11n (HT20), 802.11ac (VHT20): 5 802.11n (HT40), 802.11ac (VHT40): 2 802.11ac (VHT80): 1
Output Power	CDD Mode: 5180 ~ 5240MHz: 75.472mW 5745 ~ 5825MHz: 433.965mW Beamforming Mode: 5180 ~ 5240MHz: 18.871mW 5745 ~ 5825MHz: 98.982mW
Antenna Type	Chip antenna with 2.1dBi gain
Antenna Connector	NA
Accessory Device	NA
Cable Supplied	NA

Note:

1. The EUT incorporates a MIMO function. Physically, the EUT provides 4 completed transmitter and 4 receivers.

Modulation Mode	Beamforming Mode	TX Function
802.11a	Not Support	4TX
802.11n (HT20)	Support	4TX
802.11n (HT40)	Support	4TX
802.11ac (VHT20)	Support	4TX
802.11ac (VHT40)	Support	4TX
802.11ac (VHT80)	Support	4TX

* The modulation and bandwidth are similar for 802.11n mode for HT20/HT40 and 802.11ac mode for VHT20/VHT40. After pre-testing, 802.11ac (VHT20/VHT40) power is lower than 802.11n (HT20/HT40), therefore 802.11n (HT20/HT40) is the worst case to representative mode in test report. (Final test mode refer section 3.2.1)

* For 802.11n, CDD mode and Beamforming mode are presented in power output test item. For other test items, CDD mode is the worst case for final tests after pretesting.

2. The EUT has two sale types.

Type	Description
A	Without LTE function, BT internal ant.
B	With LTE function, BT external ant.

3. The following RF Modules are for the EUT.

RF Module	Band
Module 1	5180 ~ 5240MHz
Module 2	5745 ~ 5825MHz
Module 3	2412 ~ 2462MHz

4. The EUT uses following adapter and POE.

Adapter (Support unit)	
Brand	EDACPOWER ELEC.
Model	EA1062SGR-480
Input Power	100-240Vac, 50-60Hz, 2.5A
Output Power	48Vdc, 1.35A
Power Line	1.2m DC cable with one core

POE (Support unit)	
Model	APOE02-WM
Output Power	48Vdc

5. WLAN, zigbee and Bluetooth technology can transmit at same time.

3.2 Description of Test Modes

For 5180 ~ 5240MHz:

4 channels are provided for 802.11a, 802.11n (HT20), 802.11ac (VHT20):

Channel	Frequency	Channel	Frequency
36	5180 MHz	44	5220 MHz
40	5200 MHz	48	5240 MHz

2 channels are provided for 802.11n (HT40), 802.11ac (VHT40):

Channel	Frequency	Channel	Frequency
38	5190 MHz	46	5230 MHz

1 channel is provided for 802.11ac (VHT80):

Channel	Frequency
42	5210MHz

For 5745 ~ 5825MHz:

5 channels are provided for 802.11a, 802.11n (HT20), 802.11ac (VHT20):

Channel	Frequency	Channel	Frequency
149	5745MHz	161	5805MHz
153	5765MHz	165	5825MHz
157	5785MHz		

2 channels are provided for 802.11n (HT40), 802.11ac (VHT40):

Channel	Frequency	Channel	Frequency
151	5755MHz	159	5795MHz

1 channel is provided for 802.11ac (VHT80):

Channel	Frequency
155	5775MHz

3.2.1 Test Mode Applicability and Tested Channel Detail

EUT Configure Mode	Applicable to				Description
	RE \geq 1G	RE<1G	PLC	APCM	
A	√	√	√	√	Power from adapter
B	-	√	√	-	Power from POE

Where RE \geq 1G: Radiated Emission above 1GHz & Bandedge Measurement
 RE<1G: Radiated Emission below 1GHz
 PLC: Power Line Conducted Emission
 APCM: Antenna Port Conducted Measurement

Note:

1. The EUT had been pre-tested on the positioned of each 3 axis. The worst case was found when positioned on **X-plane**.
2. Radiated emission test (below 1GHz) and power line conducted emission test items chosen the worst maximum power.

Radiated Emission Test (Above 1GHz):

- Pre-Scan has been conducted to determine the worst-case mode from all possible combinations between available modulations, data rates and antenna ports (if EUT with antenna diversity architecture).
- Following channel(s) was (were) selected for the final test as listed below.

EUT Configure Mode	Mode	Frequency Band (MHz)	Available Channel	Tested Channel	Modulation Technology	Data Rate (Mbps)
A	802.11a	5180-5240	36 to 48	36, 40, 48	OFDM	6.0
	802.11n (HT20)		36 to 48	36, 40, 48	OFDM	6.5
	802.11n (HT40)		38 to 46	38, 46	OFDM	13.5
	802.11ac (VHT80)		42	42	OFDM	29.3
A	802.11a	5745-5825	149 to 165	149, 157, 165	OFDM	6.0
	802.11n (HT20)		149 to 165	149, 157, 165	OFDM	6.5
	802.11n (HT40)		151 to 159	151, 159	OFDM	13.5
	802.11ac (VHT80)		155	155	OFDM	29.3

Radiated Emission Test (Below 1GHz):

- Pre-Scan has been conducted to determine the worst-case mode from all possible combinations between available modulations, data rates and antenna ports (if EUT with antenna diversity architecture).
- Following channel(s) was (were) selected for the final test as listed below.

EUT Configure Mode	Mode	Frequency Band (MHz)	Available Channel	Tested Channel	Modulation Technology	Data Rate (Mbps)
A, B	802.11a	5180-5240	36 to 48	157	OFDM	6.0
A, B	802.11a	5745-5825	149 to 165		OFDM	6.0

Power Line Conducted Emission Test:

- Pre-Scan has been conducted to determine the worst-case mode from all possible combinations between available modulations, data rates and antenna ports (if EUT with antenna diversity architecture).
- Following channel(s) was (were) selected for the final test as listed below.

EUT Configure Mode	Mode	Frequency Band (MHz)	Available Channel	Tested Channel	Modulation Technology	Data Rate (Mbps)
A, B	802.11a	5180-5240	36 to 48	157	OFDM	6.0
A, B	802.11a	5745-5825	149 to 165		OFDM	6.0

Antenna Port Conducted Measurement:

- This item includes all test value of each mode, but only includes spectrum plot of worst value of each mode.
- Pre-Scan has been conducted to determine the worst-case mode from all possible combinations between available modulations, data rates and antenna ports (if EUT with antenna diversity architecture).
- Following channel(s) was (were) selected for the final test as listed below.

EUT Configure Mode	Mode	Frequency Band (MHz)	Available Channel	Tested Channel	Modulation Technology	Data Rate (Mbps)
A	802.11a	5180-5240	36 to 48	36, 40, 48	OFDM	6.0
	802.11n (HT20)		36 to 48	36, 40, 48	OFDM	6.5
	802.11n (HT40)		38 to 46	38, 46	OFDM	13.5
	802.11ac (VHT80)		42	42	OFDM	29.3
A	802.11a	5745-5825	149 to 165	149, 157, 165	OFDM	6.0
	802.11n (HT20)		149 to 165	149, 157, 165	OFDM	6.5
	802.11n (HT40)		151 to 159	151, 159	OFDM	13.5
	802.11ac (VHT80)		155	155	OFDM	29.3

Test Condition:

Applicable to	Environmental Conditions	Input Power	Tested by
RE _≥ 1G	23 deg. C, 68% RH	120Vac, 60Hz	Adair Peng
RE<1G	22 deg. C, 66% RH	120Vac, 60Hz 48Vdc	Adair Peng
PLC	25 deg. C, 75% RH	120Vac, 60Hz 48Vdc	Jones Chang
APCM	25 deg. C, 60% RH	120Vac, 60Hz	Ted Chang

3.3 Duty Cycle of Test Signal

802.11n (HT20): Duty cycle of test signal is $\geq 98\%$, duty factor is not required.

802.11a, 802.11n (HT40), 802.11ac (VHT80): Duty cycle of test signal is $< 98\%$, duty factor is required.

802.11a: Duty cycle = $2.060/2.140 = 0.963$, Duty factor = $10 * \log (1/0.963) = 0.17$

802.11n (HT20): Duty cycle = $5.000/5.090 = 0.982$

802.11n (HT40): Duty cycle = $2.405/2.500 = 0.962$, Duty factor = $10 * \log (1/0.962) = 0.17$

802.11ac (VHT80): Duty cycle = $1.143/1.224 = 0.934$, Duty factor = $10 * \log (1/0.934) = 0.30$

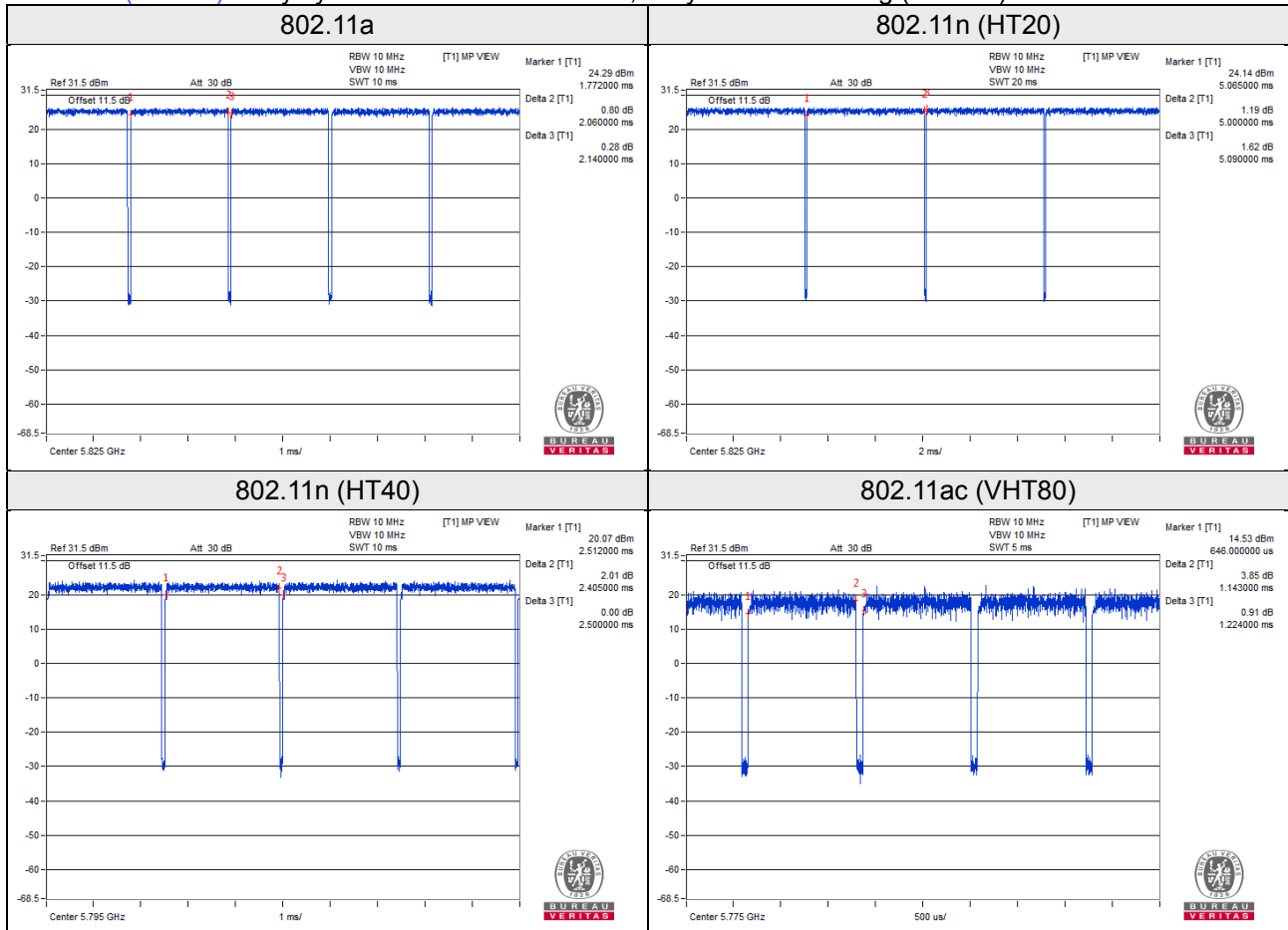

3.4 Description of Support Units

The EUT has been tested as an independent unit together with other necessary accessories or support units. The following support units or accessories were used to form a representative test configuration during the tests.

ID	Product	Brand	Model No.	Serial No.	FCC ID	Remarks
A.	Notebook	DELL	E5410	1HC2XM1	FCC DoC Approved	-
B.	POE	NA	APOE02-WM	NA	NA	Provided by manufacturer

Note:

1. All power cords of the above support units are non-shielded (1.8m).
2. Item A acted as a communication partner to transfer data.

ID	Descriptions	Qty.	Length (m)	Shielding (Yes/No)	Cores (Qty.)	Remarks
1.	LAN cable	1	1.5	N	0	RJ45, Cat5e
2.	LAN cable	1	5	N	0	RJ45, Cat5e

3.4.1 Configuration of System under Test

Adapter Mode

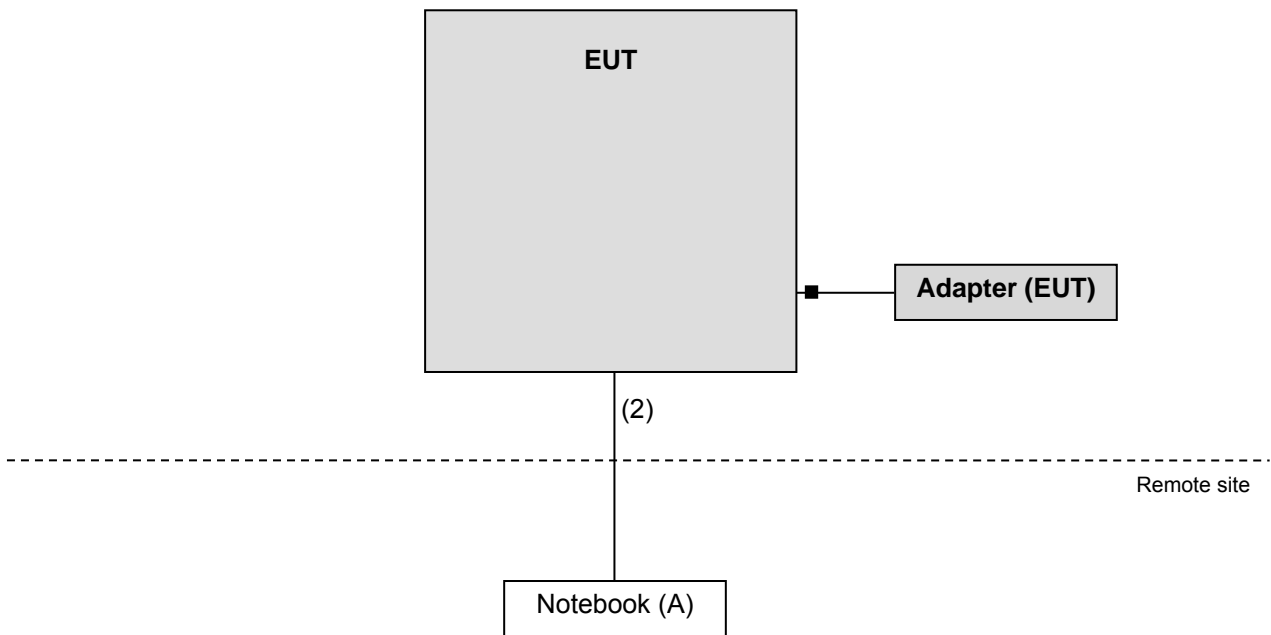

POE Mode

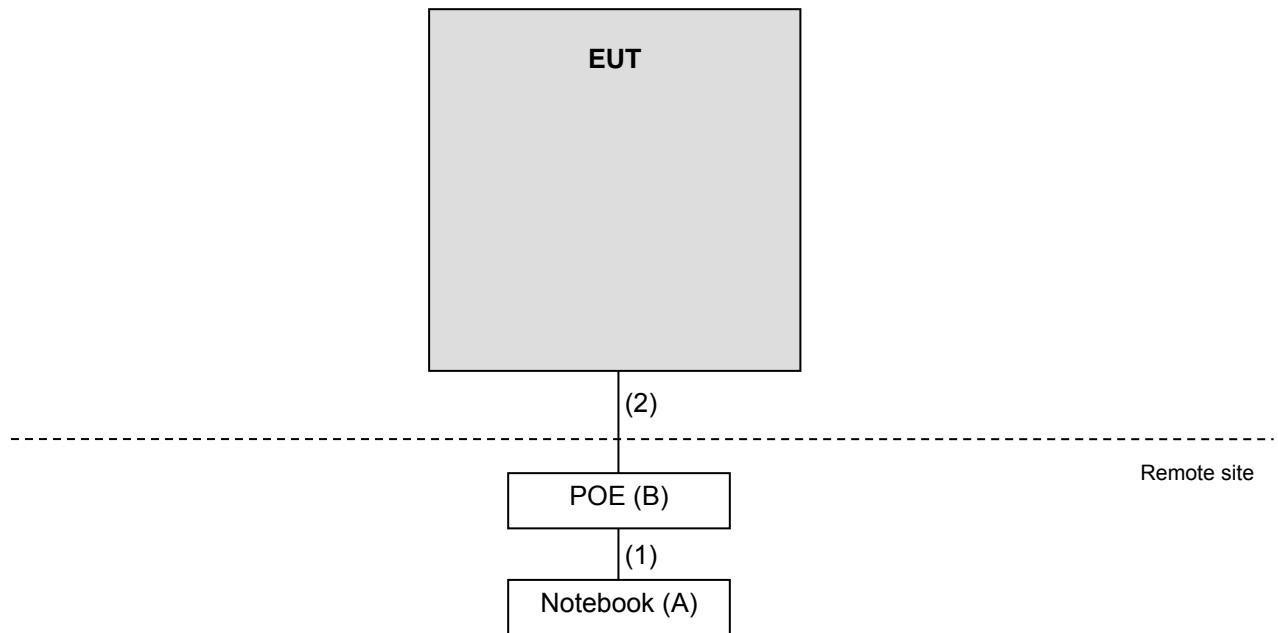

3.5 General Description of Applied Standards and References

The EUT is a RF Product. According to the specifications of the manufacturer, it must comply with the requirements of the following standards:

Test standard:

FCC Part 15, Subpart E (15.407)

ANSI C63.10:2013

All test items have been performed and recorded as per the above standards.

References Test Guidance:

KDB 789033 D02 General UNII Test Procedure New Rules v02r01

KDB 662911 D01 Multiple Transmitter Output v02r01

All test items have been performed as a reference to the above KDB test guidance.

4 Test Types and Results

4.1 Radiated Emission and Bandedge Measurement

4.1.1 Limits of Radiated Emission and Bandedge Measurement

Radiated emissions which fall in the restricted bands must comply with the radiated emission limits specified as below table.

Frequencies (MHz)	Field Strength (microvolts/meter)	Measurement Distance (meters)
0.009 ~ 0.490	2400/F(kHz)	300
0.490 ~ 1.705	24000/F(kHz)	30
1.705 ~ 30.0	30	30
30 ~ 88	100	3
88 ~ 216	150	3
216 ~ 960	200	3
Above 960	500	3

Note:

1. The lower limit shall apply at the transition frequencies.
2. Emission level (dBuV/m) = 20 log Emission level (uV/m).
3. For frequencies above 1000MHz, the field strength limits are based on average detector, however, the peak field strength of any emission shall not exceed the maximum permitted average limits, specified above by more than 20dB under any condition of modulation.

Limits of unwanted emission out of the restricted bands

Applicable To		Limit	
789033 D02 General UNII Test Procedure New Rules v02r01		Field Strength at 3m	
		PK: 74 (dBuV/m)	AV: 54 (dBuV/m)
Frequency Band	Applicable To	EIRP Limit	Equivalent Field Strength at 3m
5150~5250 MHz	15.407(b)(1)	PK: -27 (dBm/MHz)	PK: 68.2(dBuV/m)
5250~5350 MHz	15.407(b)(2)		
5470~5725 MHz	15.407(b)(3)		
5725~5850 MHz	<input checked="" type="checkbox"/> 15.407(b)(4)(i)	PK: -27 (dBm/MHz) ^{*1} PK: 10 (dBm/MHz) ^{*2} PK: 15.6 (dBm/MHz) ^{*3} PK: 27 (dBm/MHz) ^{*4}	PK: 68.2(dBuV/m) ^{*1} PK: 105.2 (dBuV/m) ^{*2} PK: 110.8(dBuV/m) ^{*3} PK: 122.2 (dBuV/m) ^{*4}
	<input type="checkbox"/> 15.407(b)(4)(ii)	Emission limits in section 15.247(d)	
^{*1} beyond 75 MHz or more above of the band edge.		^{*2} below the band edge increasing linearly to 10 dBm/MHz at 25 MHz above.	
^{*3} below the band edge increasing linearly to a level of 15.6 dBm/MHz at 5 MHz above.		^{*4} from 5 MHz above or below the band edge increasing linearly to a level of 27 dBm/MHz at the band edge.	

Note: The following formula is used to convert the equipment isotropic radiated power (eirp) to field strength:

$$E = \frac{1000000 \sqrt{30P}}{3} \mu\text{V/m, where } P \text{ is the eirp (Watts).}$$

4.1.2 Test Instruments

Description & Manufacturer	Model No.	Serial No.	Cal. Date	Cal. Due
Test Receiver ROHDE & SCHWARZ	ESIB7	100187	May 30, 2019	May 29, 2020
BILOG Antenna SCHWARZBECK	VULB9168	9168-171	Nov. 22, 2018	Nov. 21, 2019
			Nov. 11, 2019	Nov. 10, 2020
HORN Antenna SCHWARZBECK	9120D	209	Nov. 25, 2018	Nov. 24, 2019
			Nov. 24, 2019	Nov. 23, 2020
HORN Antenna SCHWARZBECK	BBHA 9170	BBHA9170241	Nov. 25, 2018	Nov. 24, 2019
			Nov. 24, 2019	Nov. 23, 2020
Loop Antenna TESEQ	HLA 6121	45745	Jul. 01, 2019	Jun. 30, 2020
Preamplifier Agilent (Below 1GHz)	8447D	2944A10738	Aug. 20, 2019	Aug. 19, 2020
Preamplifier Agilent (Above 1GHz)	8449B	3008A02465	Mar. 27, 2019	Mar. 26, 2020
RF Coaxial Cable WOKEN With 5dB PAD	8D-FB	Cable-CH3-01	Aug. 20, 2019	Aug. 19, 2020
RF signal cable HUBER+SUHNER	SUCOFLEX 104	Cable-CH3-03 (223653/4)	Aug. 20, 2019	Aug. 19, 2020
RF signal cable HUBER+SUHNER& EMCI	SUCOFLEX 104&EMC104-SM-S M-8000	Cable-CH3-03 (309224+170907)	Aug. 20, 2019	Aug. 19, 2020
Software BV ADT	ADT_Radiated_ V7.6.15.9.5	NA	NA	NA
Antenna Tower inn-co GmbH	MA 4000	013303	NA	NA
Antenna Tower Controller BV ADT	AT100	AT93021702	NA	NA
Turn Table BV ADT	TT100	TT93021702	NA	NA
Turn Table Controller BV ADT	SC100	SC93021702	NA	NA
Boresight Antenna Fixture	FBA-01	FBA-SIP01	NA	NA
Pre-amplifier (18GHz-40GHz) EMC	EMC184045B	980175	Sep. 05, 2019	Sep. 04, 2020
USB Wideband Power Sensor KEYSIGHT	U2021XA	MY55050005/MY5519 0004/MY55190007/MY 55210005	Jul. 15, 2019	Jul. 14, 2020

Note: 1. The calibration interval of the above test instruments is 12 months and the calibrations are traceable to NML/ROC and NIST/USA.
2. The test was performed in HwaYa Chamber 3.

4.1.3 Test Procedures

For Radiated emission below 30MHz

- a. The EUT was placed on the top of a rotating table 0.8 meters above the ground at a 3 meter chamber room. The table was rotated 360 degrees to determine the position of the highest radiation.
- b. The EUT was set 3 meters away from the interference-receiving antenna, which was mounted on the top of a variable-height antenna tower.
- c. Parallel, perpendicular, and ground-parallel orientations of the antenna are set to make the measurement.
- d. For each suspected emission, the EUT was arranged to its worst case and the rotatable table was turned from 0 degrees to 360 degrees to find the maximum reading.
- e. The test-receiver system was set to Quasi-Peak Detect Function and Specified Bandwidth with Maximum Hold Mode.

Note:

1. The resolution bandwidth and video bandwidth of test receiver/spectrum analyzer is 9kHz at frequency below 30MHz.

For Radiated emission above 30MHz

- a. The EUT was placed on the top of a rotating table 0.8 meters (for 30MHz ~ 1GHz) / 1.5 meters (for above 1GHz) above the ground at 3 meter chamber room for test. The table was rotated 360 degrees to determine the position of the highest radiation.
- b. The EUT was set 3 meters away from the interference-receiving antenna, which was mounted on the top of a variable-height antenna tower.
- c. The height of antenna is varied from one meter to four meters above the ground to determine the maximum value of the field strength. Both horizontal and vertical polarizations of the antenna are set to make the measurement.
- d. For each suspected emission, the EUT was arranged to its worst case and then the antenna was tuned to heights from 1 meter to 4 meters and the rotatable table was turned from 0 degrees to 360 degrees to find the maximum reading.
- e. The test-receiver system was set to quasi-peak detect function and specified bandwidth with maximum hold mode when the test frequency is below 1 GHz.
- f. The test-receiver system was set to peak and average detect function and specified bandwidth with maximum hold mode when the test frequency is above 1 GHz. If the peak reading value also meets average limit, measurement with the average detector is unnecessary.

Note:

1. The resolution bandwidth and video bandwidth of test receiver/spectrum analyzer is 120kHz for Quasi-peak detection (QP) at frequency below 1GHz.
2. The resolution bandwidth of test receiver/spectrum analyzer is 1 MHz and the video bandwidth is 3 MHz for Peak detection (PK) at frequency above 1GHz.
3. The resolution bandwidth of test receiver/spectrum analyzer is 1MHz and the video bandwidth is $\geq 1/T$ (Duty cycle < 98%) or 10Hz (Duty cycle $\geq 98\%$) for Average detection (AV) at frequency above 1GHz. (802.11a: RBW = 1MHz, VBW = 1kHz; 802.11n (HT20): RBW = 1MHz, VBW = 10Hz; 802.11n (HT40): RBW = 1MHz, VBW = 1kHz; 802.11ac (VHT80): RBW = 1MHz, VBW = 1kHz)
4. All modes of operation were investigated and the worst-case emissions are reported.

4.1.4 Deviation from Test Standard

No deviation.

4.1.5 Test Setup

For Radiated emission below 30MHz

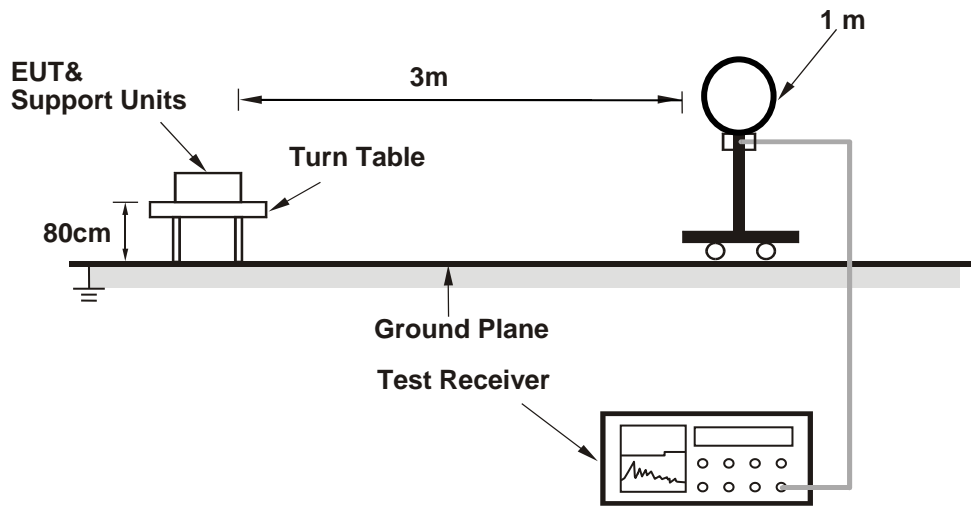

For Radiated emission 30MHz to 1GHz

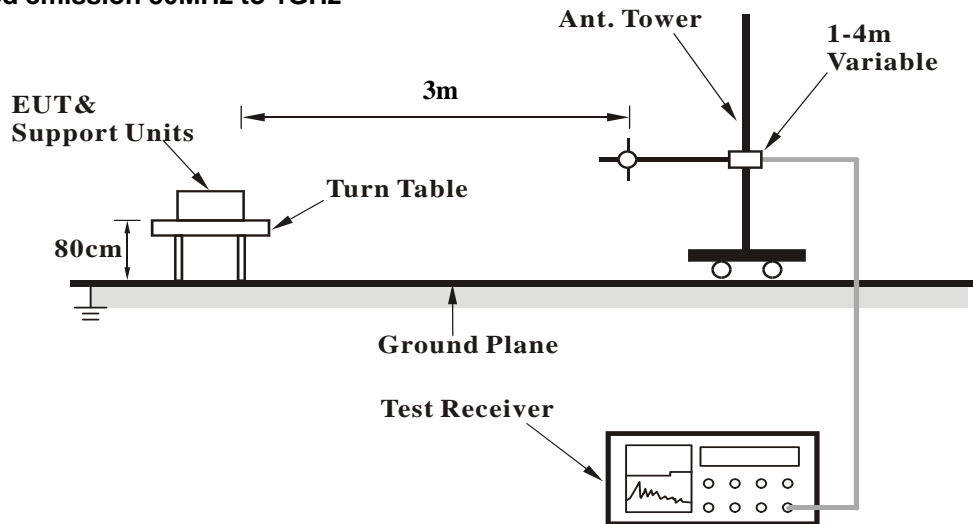

For Radiated emission above 1GHz

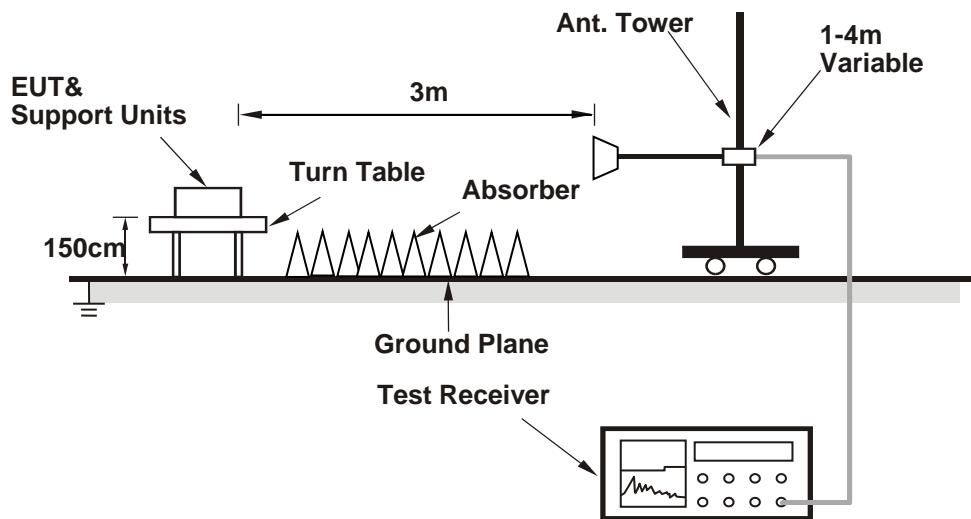

For the actual test configuration, please refer to the attached file (Test Setup Photo).

4.1.6 EUT Operating Conditions

- a. Placed the EUT on the testing table.
- b. Prepared a notebook to act as a communication partner and placed it outside of testing area.
- c. The communication partner connected with EUT via a RJ45 cable and ran a test program (CMD) to enable EUT under transmission condition continuously at specific channel frequency.
- d. The necessary accessories enable the system in full functions.

4.1.7 Test Results

Above 1GHz data:

802.11a

CHANNEL	TX Channel 36	DETECTOR FUNCTION	Peak (PK) Average (AV)
FREQUENCY RANGE	1GHz ~ 40GHz		

ANTENNA POLARITY & TEST DISTANCE: HORIZONTAL AT 3 M								
NO.	FREQ. (MHz)	EMISSION LEVEL (dBuV/m)	LIMIT (dBuV/m)	MARGIN (dB)	ANTENNA HEIGHT (m)	TABLE ANGLE (Degree)	RAW VALUE (dBuV)	CORRECTION FACTOR (dB/m)
1	5150.00	55.8 PK	74.0	-18.2	1.49 H	357	51.6	4.2
2	5150.00	42.8 AV	54.0	-11.2	1.49 H	357	38.6	4.2
3	*5180.00	109.8 PK			1.47 H	358	70.4	39.4
4	*5180.00	99.4 AV			1.47 H	358	60.0	39.4
5	#10360.00	58.7 PK	68.2	-9.5	1.49 H	203	41.2	17.5
ANTENNA POLARITY & TEST DISTANCE: VERTICAL AT 3 M								
NO.	FREQ. (MHz)	EMISSION LEVEL (dBuV/m)	LIMIT (dBuV/m)	MARGIN (dB)	ANTENNA HEIGHT (m)	TABLE ANGLE (Degree)	RAW VALUE (dBuV)	CORRECTION FACTOR (dB/m)
1	5150.00	55.4 PK	74.0	-18.6	2.56 V	322	51.2	4.2
2	5150.00	42.5 AV	54.0	-11.5	2.56 V	322	38.3	4.2
3	*5180.00	109.1 PK			2.54 V	316	69.7	39.4
4	*5180.00	98.5 AV			2.54 V	316	59.1	39.4
5	#10360.00	59.9 PK	68.2	-8.3	2.49 V	144	42.4	17.5

Remarks:

1. Emission Level(dBuV/m) = Raw Value(dBuV) + Correction Factor(dB/m).
2. Correction Factor(dB/m) = Antenna Factor(dB/m) + Cable Factor(dB) – Pre-Amplifier Factor(dB).
3. Margin value = Emission Level – Limit value.
4. The other emission levels were very low against the limit.
5. " * ": Fundamental frequency.
6. " # ": The radiated frequency is out of the restricted band.

CHANNEL	TX Channel 40	DETECTOR FUNCTION	Peak (PK) Average (AV)
FREQUENCY RANGE	1GHz ~ 40GHz		

ANTENNA POLARITY & TEST DISTANCE: HORIZONTAL AT 3 M

NO.	FREQ. (MHz)	EMISSION LEVEL (dBuV/m)	LIMIT (dBuV/m)	MARGIN (dB)	ANTENNA HEIGHT (m)	TABLE ANGLE (Degree)	RAW VALUE (dBuV)	CORRECTION FACTOR (dB/m)
1	5150.00	56.5 PK	74.0	-17.5	1.52 H	359	52.3	4.2
2	5150.00	43.1 AV	54.0	-10.9	1.52 H	359	38.9	4.2
3	*5200.00	110.4 PK			1.47 H	360	71.1	39.3
4	*5200.00	99.2 AV			1.47 H	360	59.9	39.3
5	#10360.00	59.6 PK	68.2	-8.6	2.96 H	154	42.1	17.5

ANTENNA POLARITY & TEST DISTANCE: VERTICAL AT 3 M

NO.	FREQ. (MHz)	EMISSION LEVEL (dBuV/m)	LIMIT (dBuV/m)	MARGIN (dB)	ANTENNA HEIGHT (m)	TABLE ANGLE (Degree)	RAW VALUE (dBuV)	CORRECTION FACTOR (dB/m)
1	5150.00	56.3 PK	74.0	-17.7	2.48 V	311	52.1	4.2
2	5150.00	43.6 AV	54.0	-10.4	2.48 V	311	39.4	4.2
3	*5200.00	109.7 PK			2.43 V	314	70.4	39.3
4	*5200.00	99.1 AV			2.43 V	314	59.8	39.3
5	#10400.00	59.4 PK	68.2	-8.8	2.51 V	153	41.8	17.6

Remarks:

1. Emission Level(dBuV/m) = Raw Value(dBuV) + Correction Factor(dB/m).
2. Correction Factor(dB/m) = Antenna Factor(dB/m) + Cable Factor(dB) – Pre-Amplifier Factor(dB).
3. Margin value = Emission Level – Limit value.
4. The other emission levels were very low against the limit.
5. " * " : Fundamental frequency.
6. " # " : The radiated frequency is out of the restricted band.

CHANNEL	TX Channel 48	DETECTOR FUNCTION	Peak (PK) Average (AV)
FREQUENCY RANGE	1GHz ~ 40GHz		

ANTENNA POLARITY & TEST DISTANCE: HORIZONTAL AT 3 M

NO.	FREQ. (MHz)	EMISSION LEVEL (dBuV/m)	LIMIT (dBuV/m)	MARGIN (dB)	ANTENNA HEIGHT (m)	TABLE ANGLE (Degree)	RAW VALUE (dBuV)	CORRECTION FACTOR (dB/m)
1	*5240.00	109.8 PK			1.35 H	360	70.7	39.1
2	*5240.00	99.7 AV			1.35 H	360	60.6	39.1
3	5350.00	56.0 PK	74.0	-18.0	1.38 H	357	51.9	4.1
4	5350.00	42.9 AV	54.0	-11.1	1.38 H	357	38.8	4.1
5	#10480.00	60.5 PK	68.2	-7.7	3.03 H	156	42.1	18.4

ANTENNA POLARITY & TEST DISTANCE: VERTICAL AT 3 M

NO.	FREQ. (MHz)	EMISSION LEVEL (dBuV/m)	LIMIT (dBuV/m)	MARGIN (dB)	ANTENNA HEIGHT (m)	TABLE ANGLE (Degree)	RAW VALUE (dBuV)	CORRECTION FACTOR (dB/m)
1	*5240.00	108.8 PK			2.43 V	314	69.7	39.1
2	*5240.00	98.4 AV			2.43 V	314	59.3	39.1
3	5350.00	55.7 PK	74.0	-18.3	2.36 V	309	51.6	4.1
4	5350.00	42.6 AV	54.0	-11.4	2.36 V	309	38.5	4.1
5	#10480.00	60.2 PK	68.2	-8.0	2.53 V	163	41.8	18.4

Remarks:

1. Emission Level(dBuV/m) = Raw Value(dBuV) + Correction Factor(dB/m).
2. Correction Factor(dB/m) = Antenna Factor(dB/m) + Cable Factor(dB) – Pre-Amplifier Factor(dB).
3. Margin value = Emission Level – Limit value.
4. The other emission levels were very low against the limit.
5. " * " : Fundamental frequency.
6. " # " : The radiated frequency is out of the restricted band.

CHANNEL	TX Channel 149	DETECTOR FUNCTION	Peak (PK) Average (AV)
FREQUENCY RANGE	1GHz ~ 40GHz		

ANTENNA POLARITY & TEST DISTANCE: HORIZONTAL AT 3 M

NO.	FREQ. (MHz)	EMISSION LEVEL (dBuV/m)	LIMIT (dBuV/m)	MARGIN (dB)	ANTENNA HEIGHT (m)	TABLE ANGLE (Degree)	RAW VALUE (dBuV)	CORRECTION FACTOR (dB/m)
1	#5641.60	58.8 PK	68.2	-9.4	1.73 H	341	54.4	4.4
2	*5745.00	118.4 PK			1.73 H	341	78.3	40.1
3	*5745.00	107.5 AV			1.73 H	341	67.4	40.1
4	#5931.20	58.7 PK	68.2	-9.5	1.73 H	341	53.3	5.4
5	11490.00	60.4 PK	74.0	-13.6	2.99 H	37	41.1	19.3
6	11490.00	47.2 AV	54.0	-6.8	2.99 H	37	27.9	19.3
7	#17235.00	67.1 PK	68.2	-1.1	1.05 H	321	43.9	23.2

ANTENNA POLARITY & TEST DISTANCE: VERTICAL AT 3 M

NO.	FREQ. (MHz)	EMISSION LEVEL (dBuV/m)	LIMIT (dBuV/m)	MARGIN (dB)	ANTENNA HEIGHT (m)	TABLE ANGLE (Degree)	RAW VALUE (dBuV)	CORRECTION FACTOR (dB/m)
1	#5614.40	57.2 PK	68.2	-11.0	3.34 V	173	52.7	4.5
2	*5745.00	114.0 PK			3.34 V	173	73.9	40.1
3	*5745.00	103.8 AV			3.34 V	173	63.7	40.1
4	#5943.20	58.1 PK	68.2	-10.1	3.34 V	173	52.7	5.4
5	11490.00	60.0 PK	74.0	-14.0	2.63 V	152	40.7	19.3
6	11490.00	46.7 AV	54.0	-7.3	2.63 V	152	27.4	19.3
7	#17235.00	66.4 PK	68.2	-1.8	1.57 V	166	43.2	23.2

Remarks:

1. Emission Level(dBuV/m) = Raw Value(dBuV) + Correction Factor(dB/m).
2. Correction Factor(dB/m) = Antenna Factor(dB/m) + Cable Factor(dB) – Pre-Amplifier Factor(dB).
3. Margin value = Emission Level – Limit value.
4. The other emission levels were very low against the limit.
5. " * ": Fundamental frequency.
6. " # ": The radiated frequency is out of the restricted band.

CHANNEL	TX Channel 157	DETECTOR FUNCTION	Peak (PK) Average (AV)
FREQUENCY RANGE	1GHz ~ 40GHz		

ANTENNA POLARITY & TEST DISTANCE: HORIZONTAL AT 3 M

NO.	FREQ. (MHz)	EMISSION LEVEL (dBuV/m)	LIMIT (dBuV/m)	MARGIN (dB)	ANTENNA HEIGHT (m)	TABLE ANGLE (Degree)	RAW VALUE (dBuV)	CORRECTION FACTOR (dB/m)
1	#5645.60	58.2 PK	68.2	-10.0	1.76 H	342	53.8	4.4
2	*5785.00	118.7 PK			1.76 H	342	78.4	40.3
3	*5785.00	108.1 AV			1.76 H	342	67.8	40.3
4	#5951.20	57.6 PK	68.2	-10.6	1.76 H	342	52.2	5.4
5	11570.00	60.5 PK	74.0	-13.5	2.84 H	40	41.5	19.0
6	11570.00	47.2 AV	54.0	-6.8	2.84 H	40	28.2	19.0
7	#17355.00	66.9 PK	68.2	-1.3	1.07 H	320	42.6	24.3

ANTENNA POLARITY & TEST DISTANCE: VERTICAL AT 3 M

NO.	FREQ. (MHz)	EMISSION LEVEL (dBuV/m)	LIMIT (dBuV/m)	MARGIN (dB)	ANTENNA HEIGHT (m)	TABLE ANGLE (Degree)	RAW VALUE (dBuV)	CORRECTION FACTOR (dB/m)
1	#5604.80	58.2 PK	68.2	-10.0	3.12 V	173	53.7	4.5
2	*5785.00	115.8 PK			3.12 V	173	75.5	40.3
3	*5785.00	105.2 AV			3.12 V	173	64.9	40.3
4	#5980.00	58.2 PK	68.2	-10.0	3.12 V	173	52.7	5.5
5	11570.00	60.0 PK	74.0	-14.0	2.55 V	147	41.0	19.0
6	11570.00	46.8 AV	54.0	-7.2	2.55 V	147	27.8	19.0
7	#17355.00	66.6 PK	68.2	-1.6	1.64 V	170	42.3	24.3

Remarks:

1. Emission Level(dBuV/m) = Raw Value(dBuV) + Correction Factor(dB/m).
2. Correction Factor(dB/m) = Antenna Factor(dB/m) + Cable Factor(dB) – Pre-Amplifier Factor(dB).
3. Margin value = Emission Level – Limit value.
4. The other emission levels were very low against the limit.
5. " * ": Fundamental frequency.
6. " # ": The radiated frequency is out of the restricted band.

CHANNEL	TX Channel 165	DETECTOR FUNCTION	Peak (PK) Average (AV)
FREQUENCY RANGE	1GHz ~ 40GHz		

ANTENNA POLARITY & TEST DISTANCE: HORIZONTAL AT 3 M

NO.	FREQ. (MHz)	EMISSION LEVEL (dBuV/m)	LIMIT (dBuV/m)	MARGIN (dB)	ANTENNA HEIGHT (m)	TABLE ANGLE (Degree)	RAW VALUE (dBuV)	CORRECTION FACTOR (dB/m)
1	#5611.20	58.8 PK	68.2	-9.4	1.68 H	355	54.3	4.5
2	*5825.00	119.1 PK			1.68 H	355	78.7	40.4
3	*5825.00	108.2 AV			1.68 H	355	67.8	40.4
4	#5927.20	58.9 PK	68.2	-9.3	1.68 H	355	53.5	5.4
5	11650.00	61.1 PK	74.0	-12.9	2.84 H	42	42.2	18.9
6	11650.00	47.8 AV	54.0	-6.2	2.84 H	42	28.9	18.9
7	#17475.00	67.0 PK	68.2	-1.2	1.05 H	318	41.2	25.8

ANTENNA POLARITY & TEST DISTANCE: VERTICAL AT 3 M

NO.	FREQ. (MHz)	EMISSION LEVEL (dBuV/m)	LIMIT (dBuV/m)	MARGIN (dB)	ANTENNA HEIGHT (m)	TABLE ANGLE (Degree)	RAW VALUE (dBuV)	CORRECTION FACTOR (dB/m)
1	#5636.80	58.3 PK	68.2	-9.9	3.21 V	174	53.9	4.4
2	*5825.00	116.5 PK			3.21 V	174	76.1	40.4
3	*5825.00	105.9 AV			3.21 V	174	65.5	40.4
4	#5990.40	57.8 PK	68.2	-10.4	3.21 V	174	52.3	5.5
5	11650.00	60.6 PK	74.0	-13.4	2.59 V	155	41.7	18.9
6	11650.00	47.4 AV	54.0	-6.6	2.59 V	155	28.5	18.9
7	#17475.00	66.8 PK	68.2	-1.4	1.63 V	152	41.0	25.8

Remarks:

1. Emission Level(dBuV/m) = Raw Value(dBuV) + Correction Factor(dB/m).
2. Correction Factor(dB/m) = Antenna Factor(dB/m) + Cable Factor(dB) – Pre-Amplifier Factor(dB).
3. Margin value = Emission Level – Limit value.
4. The other emission levels were very low against the limit.
5. " * ": Fundamental frequency.
6. " # ": The radiated frequency is out of the restricted band.

802.11n (HT20)

CHANNEL	TX Channel 36	DETECTOR FUNCTION	Peak (PK) Average (AV)
FREQUENCY RANGE	1GHz ~ 40GHz		

ANTENNA POLARITY & TEST DISTANCE: HORIZONTAL AT 3 M

NO.	FREQ. (MHz)	EMISSION LEVEL (dBuV/m)	LIMIT (dBuV/m)	MARGIN (dB)	ANTENNA HEIGHT (m)	TABLE ANGLE (Degree)	RAW VALUE (dBuV)	CORRECTION FACTOR (dB/m)
1	5150.00	55.4 PK	74.0	-18.6	1.48 H	3	51.2	4.2
2	5150.00	42.8 AV	54.0	-11.2	1.48 H	3	38.6	4.2
3	*5180.00	110.2 PK			1.45 H	360	70.8	39.4
4	*5180.00	99.3 AV			1.45 H	360	59.9	39.4
5	#10360.00	59.4 PK	68.2	-8.8	3.02 H	148	41.9	17.5

ANTENNA POLARITY & TEST DISTANCE: VERTICAL AT 3 M

NO.	FREQ. (MHz)	EMISSION LEVEL (dBuV/m)	LIMIT (dBuV/m)	MARGIN (dB)	ANTENNA HEIGHT (m)	TABLE ANGLE (Degree)	RAW VALUE (dBuV)	CORRECTION FACTOR (dB/m)
1	5150.00	56.4 PK	74.0	-17.6	2.52 V	309	52.2	4.2
2	5150.00	43.4 AV	54.0	-10.6	2.52 V	309	39.2	4.2
3	*5180.00	109.3 PK			2.54 V	316	69.9	39.4
4	*5180.00	98.6 AV			2.54 V	316	59.2	39.4
5	#10360.00	59.5 PK	68.2	-8.7	2.55 V	161	42.0	17.5

Remarks:

1. Emission Level(dBuV/m) = Raw Value(dBuV) + Correction Factor(dB/m).
2. Correction Factor(dB/m) = Antenna Factor(dB/m) + Cable Factor(dB) – Pre-Amplifier Factor(dB).
3. Margin value = Emission Level – Limit value.
4. The other emission levels were very low against the limit.
5. " * ": Fundamental frequency.
6. " # ": The radiated frequency is out of the restricted band.

CHANNEL	TX Channel 40	DETECTOR FUNCTION	Peak (PK) Average (AV)
FREQUENCY RANGE	1GHz ~ 40GHz		

ANTENNA POLARITY & TEST DISTANCE: HORIZONTAL AT 3 M								
NO.	FREQ. (MHz)	EMISSION LEVEL (dBuV/m)	LIMIT (dBuV/m)	MARGIN (dB)	ANTENNA HEIGHT (m)	TABLE ANGLE (Degree)	RAW VALUE (dBuV)	CORRECTION FACTOR (dB/m)
1	5150.00	55.6 PK	74.0	-18.4	1.21 H	345	51.4	4.2
2	5150.00	42.4 AV	54.0	-11.6	1.21 H	345	38.2	4.2
3	*5200.00	110.5 PK			1.17 H	343	71.2	39.3
4	*5200.00	100.0 AV			1.17 H	343	60.7	39.3
5	#10400.00	60.3 PK	68.2	-7.9	3.02 H	156	42.7	17.6

ANTENNA POLARITY & TEST DISTANCE: VERTICAL AT 3 M								
NO.	FREQ. (MHz)	EMISSION LEVEL (dBuV/m)	LIMIT (dBuV/m)	MARGIN (dB)	ANTENNA HEIGHT (m)	TABLE ANGLE (Degree)	RAW VALUE (dBuV)	CORRECTION FACTOR (dB/m)
1	5150.00	56.2 PK	74.0	-17.8	2.61 V	316	52.0	4.2
2	5150.00	43.2 AV	54.0	-10.8	2.61 V	316	39.0	4.2
3	*5200.00	109.6 PK			2.56 V	314	70.3	39.3
4	*5200.00	98.8 AV			2.56 V	314	59.5	39.3
5	#10400.00	60.4 PK	68.2	-7.8	2.63 V	158	42.8	17.6

Remarks:

1. Emission Level(dBuV/m) = Raw Value(dBuV) + Correction Factor(dB/m).
2. Correction Factor(dB/m) = Antenna Factor(dB/m) + Cable Factor(dB) – Pre-Amplifier Factor(dB).
3. Margin value = Emission Level – Limit value.
4. The other emission levels were very low against the limit.
5. " * ": Fundamental frequency.
6. " # ": The radiated frequency is out of the restricted band.

CHANNEL	TX Channel 48	DETECTOR FUNCTION	Peak (PK) Average (AV)
FREQUENCY RANGE	1GHz ~ 40GHz		

ANTENNA POLARITY & TEST DISTANCE: HORIZONTAL AT 3 M

NO.	FREQ. (MHz)	EMISSION LEVEL (dBuV/m)	LIMIT (dBuV/m)	MARGIN (dB)	ANTENNA HEIGHT (m)	TABLE ANGLE (Degree)	RAW VALUE (dBuV)	CORRECTION FACTOR (dB/m)
1	*5240.00	110.3 PK			1.36 H	360	71.2	39.1
2	*5240.00	99.6 AV			1.36 H	360	60.5	39.1
3	5350.00	56.5 PK	74.0	-17.5	1.38 H	358	52.4	4.1
4	5350.00	42.8 AV	54.0	-11.2	1.38 H	358	38.7	4.1
5	#10480.00	60.7 PK	68.2	-7.5	3.05 H	166	42.3	18.4

ANTENNA POLARITY & TEST DISTANCE: VERTICAL AT 3 M

NO.	FREQ. (MHz)	EMISSION LEVEL (dBuV/m)	LIMIT (dBuV/m)	MARGIN (dB)	ANTENNA HEIGHT (m)	TABLE ANGLE (Degree)	RAW VALUE (dBuV)	CORRECTION FACTOR (dB/m)
1	*5240.00	109.4 PK			2.38 V	317	70.3	39.1
2	*5240.00	98.5 AV			2.38 V	317	59.4	39.1
3	5350.00	56.4 PK	74.0	-17.6	2.41 V	320	52.3	4.1
4	5350.00	42.9 AV	54.0	-11.1	2.41 V	320	38.8	4.1
5	#10480.00	60.5 PK	68.2	-7.7	2.49 V	166	42.1	18.4

Remarks:

1. Emission Level(dBuV/m) = Raw Value(dBuV) + Correction Factor(dB/m).
2. Correction Factor(dB/m) = Antenna Factor(dB/m) + Cable Factor(dB) – Pre-Amplifier Factor(dB).
3. Margin value = Emission Level – Limit value.
4. The other emission levels were very low against the limit.
5. " * " : Fundamental frequency.
6. " # " : The radiated frequency is out of the restricted band.

CHANNEL	TX Channel 149	DETECTOR FUNCTION	Peak (PK) Average (AV)
FREQUENCY RANGE	1GHz ~ 40GHz		

ANTENNA POLARITY & TEST DISTANCE: HORIZONTAL AT 3 M

NO.	FREQ. (MHz)	EMISSION LEVEL (dBuV/m)	LIMIT (dBuV/m)	MARGIN (dB)	ANTENNA HEIGHT (m)	TABLE ANGLE (Degree)	RAW VALUE (dBuV)	CORRECTION FACTOR (dB/m)
1	#5645.60	57.8 PK	68.2	-10.4	1.69 H	337	53.4	4.4
2	*5745.00	117.9 PK			1.69 H	337	77.8	40.1
3	*5745.00	106.8 AV			1.69 H	337	66.7	40.1
4	#5997.60	57.9 PK	68.2	-10.3	1.69 H	337	52.4	5.5
5	11490.00	60.2 PK	74.0	-13.8	2.84 H	42	40.9	19.3
6	11490.00	47.0 AV	54.0	-7.0	2.84 H	42	27.7	19.3
7	#17235.00	66.9 PK	68.2	-1.3	1.10 H	328	43.7	23.2

ANTENNA POLARITY & TEST DISTANCE: VERTICAL AT 3 M

NO.	FREQ. (MHz)	EMISSION LEVEL (dBuV/m)	LIMIT (dBuV/m)	MARGIN (dB)	ANTENNA HEIGHT (m)	TABLE ANGLE (Degree)	RAW VALUE (dBuV)	CORRECTION FACTOR (dB/m)
1	#5609.60	58.2 PK	68.2	-10.0	3.10 V	172	53.7	4.5
2	*5745.00	114.3 PK			3.10 V	172	74.2	40.1
3	*5745.00	103.5 AV			3.10 V	172	63.4	40.1
4	#5990.40	57.7 PK	68.2	-10.5	3.10 V	172	52.2	5.5
5	11490.00	59.7 PK	74.0	-14.3	2.71 V	160	40.4	19.3
6	11490.00	46.7 AV	54.0	-7.3	2.71 V	160	27.4	19.3
7	#17235.00	66.4 PK	68.2	-1.8	1.50 V	153	43.2	23.2

Remarks:

1. Emission Level(dBuV/m) = Raw Value(dBuV) + Correction Factor(dB/m).
2. Correction Factor(dB/m) = Antenna Factor(dB/m) + Cable Factor(dB) – Pre-Amplifier Factor(dB).
3. Margin value = Emission Level – Limit value.
4. The other emission levels were very low against the limit.
5. " * ": Fundamental frequency.
6. " # ": The radiated frequency is out of the restricted band.

CHANNEL	TX Channel 157	DETECTOR FUNCTION	Peak (PK) Average (AV)
FREQUENCY RANGE	1GHz ~ 40GHz		

ANTENNA POLARITY & TEST DISTANCE: HORIZONTAL AT 3 M

NO.	FREQ. (MHz)	EMISSION LEVEL (dBuV/m)	LIMIT (dBuV/m)	MARGIN (dB)	ANTENNA HEIGHT (m)	TABLE ANGLE (Degree)	RAW VALUE (dBuV)	CORRECTION FACTOR (dB/m)
1	#5616.00	57.8 PK	68.2	-10.4	1.76 H	339	53.3	4.5
2	*5785.00	119.3 PK			1.76 H	336	79.0	40.3
3	*5785.00	108.4 AV			1.76 H	336	68.1	40.3
4	#5928.80	58.6 PK	68.2	-9.6	1.76 H	339	53.2	5.4
5	11570.00	60.5 PK	74.0	-13.5	2.91 H	45	41.5	19.0
6	11570.00	47.0 AV	54.0	-7.0	2.91 H	45	28.0	19.0
7	#17355.00	66.7 PK	68.2	-1.5	1.09 H	323	42.4	24.3

ANTENNA POLARITY & TEST DISTANCE: VERTICAL AT 3 M

NO.	FREQ. (MHz)	EMISSION LEVEL (dBuV/m)	LIMIT (dBuV/m)	MARGIN (dB)	ANTENNA HEIGHT (m)	TABLE ANGLE (Degree)	RAW VALUE (dBuV)	CORRECTION FACTOR (dB/m)
1	#5631.20	57.6 PK	68.2	-10.6	3.13 V	174	53.2	4.4
2	*5785.00	116.0 PK			3.13 V	174	75.7	40.3
3	*5785.00	105.0 AV			3.13 V	174	64.7	40.3
4	#5961.60	57.7 PK	68.2	-10.5	3.13 V	174	52.3	5.4
5	11570.00	60.1 PK	74.0	-13.9	2.65 V	155	41.1	19.0
6	11570.00	46.7 AV	54.0	-7.3	2.65 V	155	27.7	19.0
7	#17355.00	66.4 PK	68.2	-1.8	1.61 V	160	42.1	24.3

Remarks:

1. Emission Level(dBuV/m) = Raw Value(dBuV) + Correction Factor(dB/m).
2. Correction Factor(dB/m) = Antenna Factor(dB/m) + Cable Factor(dB) – Pre-Amplifier Factor(dB).
3. Margin value = Emission Level – Limit value.
4. The other emission levels were very low against the limit.
5. " * ": Fundamental frequency.
6. " # ": The radiated frequency is out of the restricted band.

CHANNEL	TX Channel 165	DETECTOR FUNCTION	Peak (PK) Average (AV)
FREQUENCY RANGE	1GHz ~ 40GHz		

ANTENNA POLARITY & TEST DISTANCE: HORIZONTAL AT 3 M

NO.	FREQ. (MHz)	EMISSION LEVEL (dBuV/m)	LIMIT (dBuV/m)	MARGIN (dB)	ANTENNA HEIGHT (m)	TABLE ANGLE (Degree)	RAW VALUE (dBuV)	CORRECTION FACTOR (dB/m)
1	#5619.20	57.9 PK	68.2	-10.3	1.74 H	357	53.4	4.5
2	*5825.00	118.9 PK			1.74 H	357	78.5	40.4
3	*5825.00	107.9 AV			1.74 H	357	67.5	40.4
4	#5972.80	57.6 PK	68.2	-10.6	1.74 H	357	52.2	5.4
5	11650.00	60.9 PK	74.0	-13.1	2.90 H	47	42.0	18.9
6	11650.00	47.9 AV	54.0	-6.1	2.90 H	47	29.0	18.9
7	#17475.00	66.8 PK	68.2	-1.4	1.10 H	320	41.0	25.8

ANTENNA POLARITY & TEST DISTANCE: VERTICAL AT 3 M

NO.	FREQ. (MHz)	EMISSION LEVEL (dBuV/m)	LIMIT (dBuV/m)	MARGIN (dB)	ANTENNA HEIGHT (m)	TABLE ANGLE (Degree)	RAW VALUE (dBuV)	CORRECTION FACTOR (dB/m)
1	#5604.00	57.5 PK	68.2	-10.7	3.23 V	174	53.0	4.5
2	*5825.00	116.1 PK			3.23 V	174	75.7	40.4
3	*5825.00	105.1 AV			3.23 V	174	64.7	40.4
4	#5941.60	57.7 PK	68.2	-10.5	3.23 V	174	52.3	5.4
5	11650.00	60.4 PK	74.0	-13.6	2.70 V	159	41.5	18.9
6	11650.00	47.3 AV	54.0	-6.7	2.70 V	159	28.4	18.9
7	#17475.00	66.4 PK	68.2	-1.8	1.58 V	160	40.6	25.8

Remarks:

1. Emission Level(dBuV/m) = Raw Value(dBuV) + Correction Factor(dB/m).
2. Correction Factor(dB/m) = Antenna Factor(dB/m) + Cable Factor(dB) – Pre-Amplifier Factor(dB).
3. Margin value = Emission Level – Limit value.
4. The other emission levels were very low against the limit.
5. " * ": Fundamental frequency.
6. " # ": The radiated frequency is out of the restricted band.

802.11n (HT40)

CHANNEL	TX Channel 38	DETECTOR FUNCTION	Peak (PK) Average (AV)
FREQUENCY RANGE	1GHz ~ 40GHz		

ANTENNA POLARITY & TEST DISTANCE: HORIZONTAL AT 3 M								
NO.	FREQ. (MHz)	EMISSION LEVEL (dBuV/m)	LIMIT (dBuV/m)	MARGIN (dB)	ANTENNA HEIGHT (m)	TABLE ANGLE (Degree)	RAW VALUE (dBuV)	CORRECTION FACTOR (dB/m)
1	5150.00	55.5 PK	74.0	-18.5	1.43 H	346	51.3	4.2
2	5150.00	42.7 AV	54.0	-11.3	1.43 H	346	38.5	4.2
3	*5190.00	107.7 PK			1.40 H	343	68.4	39.3
4	*5190.00	97.1 AV			1.40 H	343	57.8	39.3
5	#10380.00	59.5 PK	68.2	-8.7	3.02 H	172	41.8	17.7

ANTENNA POLARITY & TEST DISTANCE: VERTICAL AT 3 M								
NO.	FREQ. (MHz)	EMISSION LEVEL (dBuV/m)	LIMIT (dBuV/m)	MARGIN (dB)	ANTENNA HEIGHT (m)	TABLE ANGLE (Degree)	RAW VALUE (dBuV)	CORRECTION FACTOR (dB/m)
1	5150.00	56.1 PK	74.0	-17.9	2.61 V	321	51.9	4.2
2	5150.00	42.5 AV	54.0	-11.5	2.61 V	321	38.3	4.2
3	*5190.00	105.8 PK			2.57 V	317	66.5	39.3
4	*5190.00	96.2 AV			2.57 V	317	56.9	39.3
5	#10380.00	60.0 PK	68.2	-8.2	2.63 V	149	42.3	17.7

Remarks:

1. Emission Level(dBuV/m) = Raw Value(dBuV) + Correction Factor(dB/m).
2. Correction Factor(dB/m) = Antenna Factor(dB/m) + Cable Factor(dB) – Pre-Amplifier Factor(dB).
3. Margin value = Emission Level – Limit value.
4. The other emission levels were very low against the limit.
5. " * ": Fundamental frequency.
6. " # ": The radiated frequency is out of the restricted band.

CHANNEL	TX Channel 46	DETECTOR FUNCTION	Peak (PK) Average (AV)
FREQUENCY RANGE	1GHz ~ 40GHz		

ANTENNA POLARITY & TEST DISTANCE: HORIZONTAL AT 3 M

NO.	FREQ. (MHz)	EMISSION LEVEL (dBuV/m)	LIMIT (dBuV/m)	MARGIN (dB)	ANTENNA HEIGHT (m)	TABLE ANGLE (Degree)	RAW VALUE (dBuV)	CORRECTION FACTOR (dB/m)
1	5150.00	55.4 PK	74.0	-18.6	1.42 H	345	51.2	4.2
2	5150.00	42.5 AV	54.0	-11.5	1.42 H	345	38.3	4.2
3	*5230.00	108.1 PK			1.38 H	342	69.0	39.1
4	*5230.00	98.0 AV			1.38 H	342	58.9	39.1
5	5350.00	55.8 PK	74.0	-18.2	1.46 H	347	51.7	4.1
6	5350.00	42.7 AV	54.0	-11.3	1.46 H	347	38.6	4.1
7	#10460.00	59.9 PK	68.2	-8.3	2.99 H	184	41.7	18.2

ANTENNA POLARITY & TEST DISTANCE: VERTICAL AT 3 M

NO.	FREQ. (MHz)	EMISSION LEVEL (dBuV/m)	LIMIT (dBuV/m)	MARGIN (dB)	ANTENNA HEIGHT (m)	TABLE ANGLE (Degree)	RAW VALUE (dBuV)	CORRECTION FACTOR (dB/m)
1	5150.00	55.6 PK	74.0	-18.4	2.49 V	313	51.4	4.2
2	5150.00	42.4 AV	54.0	-11.6	2.49 V	313	38.2	4.2
3	*5230.00	105.5 PK			2.51 V	317	66.4	39.1
4	*5230.00	96.3 AV			2.51 V	317	57.2	39.1
5	5350.00	56.1 PK	74.0	-17.9	2.53 V	321	52.0	4.1
6	5350.00	42.7 AV	54.0	-11.3	2.53 V	321	38.6	4.1
7	#10460.00	59.7 PK	68.2	-8.5	2.56 V	155	41.5	18.2

Remarks:

1. Emission Level(dBuV/m) = Raw Value(dBuV) + Correction Factor(dB/m).
2. Correction Factor(dB/m) = Antenna Factor(dB/m) + Cable Factor(dB) – Pre-Amplifier Factor(dB).
3. Margin value = Emission Level – Limit value.
4. The other emission levels were very low against the limit.
5. " * ": Fundamental frequency.
6. " # ": The radiated frequency is out of the restricted band.

CHANNEL	TX Channel 151	DETECTOR FUNCTION	Peak (PK) Average (AV)
FREQUENCY RANGE	1GHz ~ 40GHz		

ANTENNA POLARITY & TEST DISTANCE: HORIZONTAL AT 3 M

NO.	FREQ. (MHz)	EMISSION LEVEL (dBuV/m)	LIMIT (dBuV/m)	MARGIN (dB)	ANTENNA HEIGHT (m)	TABLE ANGLE (Degree)	RAW VALUE (dBuV)	CORRECTION FACTOR (dB/m)
1	#5644.80	59.1 PK	68.2	-9.1	1.56 H	341	54.7	4.4
2	*5755.00	115.3 PK			1.56 H	341	75.2	40.1
3	*5755.00	105.6 AV			1.56 H	341	65.5	40.1
4	#5992.80	58.3 PK	68.2	-9.9	1.56 H	341	52.8	5.5
5	11510.00	60.3 PK	74.0	-13.7	2.77 H	55	40.9	19.4
6	11510.00	47.1 AV	54.0	-6.9	2.77 H	55	27.7	19.4
7	#17265.00	67.0 PK	68.2	-1.2	1.85 H	232	43.9	23.1

ANTENNA POLARITY & TEST DISTANCE: VERTICAL AT 3 M

NO.	FREQ. (MHz)	EMISSION LEVEL (dBuV/m)	LIMIT (dBuV/m)	MARGIN (dB)	ANTENNA HEIGHT (m)	TABLE ANGLE (Degree)	RAW VALUE (dBuV)	CORRECTION FACTOR (dB/m)
1	#5646.40	57.6 PK	68.2	-10.6	3.02 V	176	53.2	4.4
2	*5755.00	112.8 PK			3.02 V	176	72.7	40.1
3	*5755.00	102.9 AV			3.02 V	176	62.8	40.1
4	#5947.20	58.0 PK	68.2	-10.2	3.02 V	176	52.6	5.4
5	11510.00	59.7 PK	74.0	-14.3	2.54 V	154	40.3	19.4
6	11510.00	46.6 AV	54.0	-7.4	2.54 V	154	27.2	19.4
7	#17265.00	66.3 PK	68.2	-1.9	1.63 V	163	43.2	23.1

Remarks:

1. Emission Level(dBuV/m) = Raw Value(dBuV) + Correction Factor(dB/m).
2. Correction Factor(dB/m) = Antenna Factor(dB/m) + Cable Factor(dB) – Pre-Amplifier Factor(dB).
3. Margin value = Emission Level – Limit value.
4. The other emission levels were very low against the limit.
5. " * ": Fundamental frequency.
6. " # ": The radiated frequency is out of the restricted band.

CHANNEL	TX Channel 159	DETECTOR FUNCTION	Peak (PK) Average (AV)
FREQUENCY RANGE	1GHz ~ 40GHz		

ANTENNA POLARITY & TEST DISTANCE: HORIZONTAL AT 3 M

NO.	FREQ. (MHz)	EMISSION LEVEL (dBuV/m)	LIMIT (dBuV/m)	MARGIN (dB)	ANTENNA HEIGHT (m)	TABLE ANGLE (Degree)	RAW VALUE (dBuV)	CORRECTION FACTOR (dB/m)
1	#5641.60	58.3 PK	68.2	-9.9	1.69 H	343	53.9	4.4
2	*5795.00	115.3 PK			1.69 H	343	74.9	40.4
3	*5795.00	105.4 AV			1.69 H	343	65.0	40.4
4	#5964.00	58.2 PK	68.2	-10.0	1.69 H	343	52.8	5.4
5	11590.00	60.5 PK	74.0	-13.5	2.85 H	61	41.6	18.9
6	11590.00	47.1 AV	54.0	-6.9	2.85 H	61	28.2	18.9
7	#17385.00	67.0 PK	68.2	-1.2	1.85 H	236	42.0	25.0

ANTENNA POLARITY & TEST DISTANCE: VERTICAL AT 3 M

NO.	FREQ. (MHz)	EMISSION LEVEL (dBuV/m)	LIMIT (dBuV/m)	MARGIN (dB)	ANTENNA HEIGHT (m)	TABLE ANGLE (Degree)	RAW VALUE (dBuV)	CORRECTION FACTOR (dB/m)
1	#5631.20	58.5 PK	68.2	-9.7	2.66 V	177	54.1	4.4
2	*5795.00	112.7 PK			2.66 V	177	72.3	40.4
3	*5795.00	102.8 AV			2.66 V	177	62.4	40.4
4	#5928.00	58.1 PK	68.2	-10.1	2.66 V	177	52.7	5.4
5	11590.00	60.0 PK	74.0	-14.0	2.59 V	156	41.1	18.9
6	11590.00	46.6 AV	54.0	-7.4	2.59 V	156	27.7	18.9
7	#17385.00	66.5 PK	68.2	-1.7	1.51 V	153	41.5	25.0

Remarks:

1. Emission Level(dBuV/m) = Raw Value(dBuV) + Correction Factor(dB/m).
2. Correction Factor(dB/m) = Antenna Factor(dB/m) + Cable Factor(dB) – Pre-Amplifier Factor(dB).
3. Margin value = Emission Level – Limit value.
4. The other emission levels were very low against the limit.
5. " * ": Fundamental frequency.
6. " # ": The radiated frequency is out of the restricted band.

802.11ac (VHT80)

CHANNEL	TX Channel 42	DETECTOR FUNCTION	Peak (PK) Average (AV)
FREQUENCY RANGE	1GHz ~ 40GHz		

ANTENNA POLARITY & TEST DISTANCE: HORIZONTAL AT 3 M

NO.	FREQ. (MHz)	EMISSION LEVEL (dBuV/m)	LIMIT (dBuV/m)	MARGIN (dB)	ANTENNA HEIGHT (m)	TABLE ANGLE (Degree)	RAW VALUE (dBuV)	CORRECTION FACTOR (dB/m)
1	5150.00	57.5 PK	74.0	-16.5	1.55 H	3	53.3	4.2
2	5150.00	43.9 AV	54.0	-10.1	1.55 H	3	39.7	4.2
3	*5210.00	103.6 PK			1.49 H	1	64.4	39.2
4	*5210.00	94.1 AV			1.49 H	1	54.9	39.2
5	5350.00	57.3 PK	74.0	-16.7	1.57 H	6	53.2	4.1
6	5350.00	43.6 AV	54.0	-10.4	1.57 H	6	39.5	4.1
7	#10420.00	59.8 PK	68.2	-8.4	3.02 H	166	41.9	17.9

ANTENNA POLARITY & TEST DISTANCE: VERTICAL AT 3 M

NO.	FREQ. (MHz)	EMISSION LEVEL (dBuV/m)	LIMIT (dBuV/m)	MARGIN (dB)	ANTENNA HEIGHT (m)	TABLE ANGLE (Degree)	RAW VALUE (dBuV)	CORRECTION FACTOR (dB/m)
1	5150.00	56.3 PK	74.0	-17.7	2.58 V	319	52.1	4.2
2	5150.00	43.3 AV	54.0	-10.7	2.58 V	319	39.1	4.2
3	*5210.00	102.8 PK			2.55 V	315	63.6	39.2
4	*5210.00	92.6 AV			2.55 V	315	53.4	39.2
5	5350.00	56.4 PK	74.0	-17.6	2.61 V	321	52.3	4.1
6	5350.00	43.3 AV	54.0	-10.7	2.61 V	321	39.2	4.1
7	#10460.00	60.5 PK	68.2	-7.7	2.69 V	173	42.3	18.2

Remarks:

1. Emission Level(dBuV/m) = Raw Value(dBuV) + Correction Factor(dB/m).
2. Correction Factor(dB/m) = Antenna Factor(dB/m) + Cable Factor(dB) – Pre-Amplifier Factor(dB).
3. Margin value = Emission Level – Limit value.
4. The other emission levels were very low against the limit.
5. " * ": Fundamental frequency.
6. " # ": The radiated frequency is out of the restricted band.

CHANNEL	TX Channel 155	DETECTOR FUNCTION	Peak (PK) Average (AV)
FREQUENCY RANGE	1GHz ~ 40GHz		

ANTENNA POLARITY & TEST DISTANCE: HORIZONTAL AT 3 M

NO.	FREQ. (MHz)	EMISSION LEVEL (dBuV/m)	LIMIT (dBuV/m)	MARGIN (dB)	ANTENNA HEIGHT (m)	TABLE ANGLE (Degree)	RAW VALUE (dBuV)	CORRECTION FACTOR (dB/m)
1	#5641.60	61.6 PK	68.2	-6.6	1.74 H	343	57.2	4.4
2	#5650.00	66.8 PK	68.2	-1.4	2.04 H	267	62.4	4.4
3	*5775.00	111.2 PK			1.74 H	343	71.0	40.2
4	*5775.00	100.8 AV			1.74 H	343	60.6	40.2
5	#5925.00	60.5 PK	68.2	-7.7	1.91 H	295	55.1	5.4
6	#5935.20	58.2 PK	68.2	-10.0	1.74 H	343	52.8	5.4
7	11550.00	60.3 PK	74.0	-13.7	2.87 H	49	41.1	19.2
8	11550.00	47.1 AV	54.0	-6.9	2.87 H	49	27.9	19.2

ANTENNA POLARITY & TEST DISTANCE: VERTICAL AT 3 M

NO.	FREQ. (MHz)	EMISSION LEVEL (dBuV/m)	LIMIT (dBuV/m)	MARGIN (dB)	ANTENNA HEIGHT (m)	TABLE ANGLE (Degree)	RAW VALUE (dBuV)	CORRECTION FACTOR (dB/m)
1	#5640.00	58.5 PK	68.2	-9.7	3.45 V	334	54.1	4.4
2	#5650.00	59.7 PK	68.2	-8.5	3.30 V	350	55.3	4.4
3	*5775.00	105.2 PK			3.45 V	334	65.0	40.2
4	*5775.00	95.6 AV			3.45 V	334	55.4	40.2
5	#5925.00	57.5 PK	68.2	-10.7	3.13 V	331	52.1	5.4
6	#5933.60	57.6 PK	68.2	-10.6	3.45 V	334	52.2	5.4
7	11550.00	60.1 PK	74.0	-13.9	2.51 V	143	40.9	19.2
8	11550.00	46.8 AV	54.0	-7.2	2.51 V	143	27.6	19.2

Remarks:

1. Emission Level(dBuV/m) = Raw Value(dBuV) + Correction Factor(dB/m).
2. Correction Factor(dB/m) = Antenna Factor(dB/m) + Cable Factor(dB) – Pre-Amplifier Factor(dB).
3. Margin value = Emission Level – Limit value.
4. The other emission levels were very low against the limit.
5. " * ": Fundamental frequency.
6. " # ": The radiated frequency is out of the restricted band.

Below 1GHz Worst-Case Data:

802.11a

CHANNEL	TX Channel 157	DETECTOR FUNCTION	Quasi-Peak (QP)
FREQUENCY RANGE	9kHz ~ 1GHz		
TEST MODE	A		

ANTENNA POLARITY & TEST DISTANCE: HORIZONTAL AT 3 M								
NO.	FREQ. (MHz)	EMISSION LEVEL (dBuV/m)	LIMIT (dBuV/m)	MARGIN (dB)	ANTENNA HEIGHT (m)	TABLE ANGLE (Degree)	RAW VALUE (dBuV)	CORRECTION FACTOR (dB/m)
1	53.11	28.1 QP	40.0	-11.9	1.00 H	312	37.1	-9.0
2	160.15	27.7 QP	43.5	-15.8	1.50 H	235	36.4	-8.7
3	216.57	29.4 QP	46.0	-16.6	1.50 H	265	40.1	-10.7
4	328.76	32.7 QP	46.0	-13.3	1.00 H	28	39.4	-6.7
5	408.30	32.2 QP	46.0	-13.8	1.00 H	54	36.5	-4.3
6	635.28	36.0 QP	46.0	-10.0	2.00 H	45	34.5	1.5

Remarks:

1. Emission Level(dBuV/m) = Raw Value(dBuV) + Correction Factor(dB/m).
2. Correction Factor(dB/m) = Antenna Factor(dB/m) + Cable Factor(dB) – Pre-Amplifier Factor(dB).
3. The other emission levels were very low against the limit of frequency range 30MHz ~ 1000MHz.
4. Margin value = Emission Level – Limit value.
5. The emission levels were very low against the limit of frequency range 9kHz ~ 30MHz: the amplitude of spurious emissions attenuated more than 20 dB below the permissible value to be report.

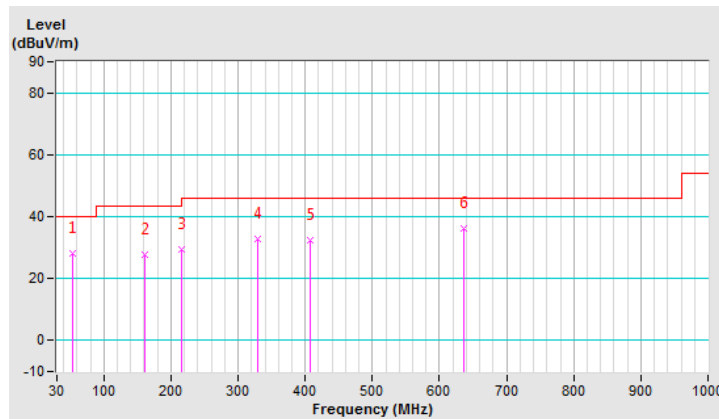

CHANNEL	TX Channel 157	DETECTOR FUNCTION	Quasi-Peak (QP)
FREQUENCY RANGE	9kHz ~ 1GHz		
TEST MODE	A		

ANTENNA POLARITY & TEST DISTANCE: VERTICAL AT 3 M								
NO.	FREQ. (MHz)	EMISSION LEVEL (dBuV/m)	LIMIT (dBuV/m)	MARGIN (dB)	ANTENNA HEIGHT (m)	TABLE ANGLE (Degree)	RAW VALUE (dBuV)	CORRECTION FACTOR (dB/m)
1	49.40	36.5 QP	40.0	-3.5	2.00 V	8	45.5	-9.0
2	102.22	38.9 QP	43.5	-4.6	2.00 V	15	51.6	-12.7
3	139.77	32.5 QP	43.5	-11.0	1.50 V	55	41.7	-9.2
4	311.30	28.0 QP	46.0	-18.0	2.00 V	211	35.0	-7.0
5	400.54	32.0 QP	46.0	-14.0	2.00 V	187	36.6	-4.6
6	625.58	41.7 QP	46.0	-4.3	2.00 V	115	40.3	1.4

Remarks:

1. Emission Level(dBuV/m) = Raw Value(dBuV) + Correction Factor(dB/m).
2. Correction Factor(dB/m) = Antenna Factor(dB/m) + Cable Factor(dB) – Pre-Amplifier Factor(dB).
3. The other emission levels were very low against the limit of frequency range 30MHz ~ 1000MHz.
4. Margin value = Emission Level – Limit value.
5. The emission levels were very low against the limit of frequency range 9kHz ~ 30MHz: the amplitude of spurious emissions attenuated more than 20 dB below the permissible value to be report.

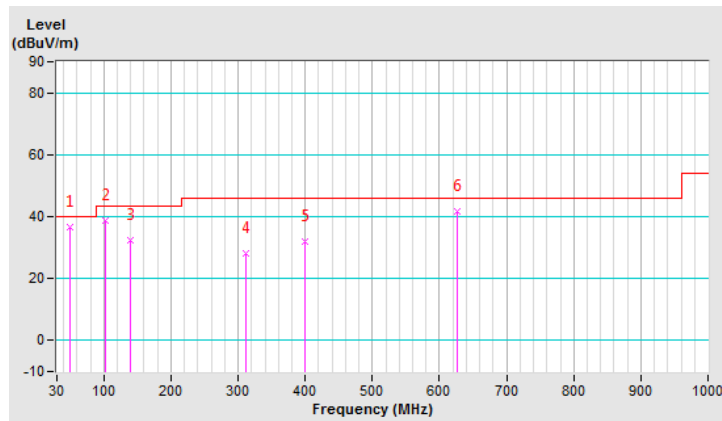

CHANNEL	TX Channel 157	DETECTOR FUNCTION	Quasi-Peak (QP)
FREQUENCY RANGE	9kHz ~ 1GHz		
TEST MODE	B		

ANTENNA POLARITY & TEST DISTANCE: HORIZONTAL AT 3 M								
NO.	FREQ. (MHz)	EMISSION LEVEL (dBuV/m)	LIMIT (dBuV/m)	MARGIN (dB)	ANTENNA HEIGHT (m)	TABLE ANGLE (Degree)	RAW VALUE (dBuV)	CORRECTION FACTOR (dB/m)
1	60.11	33.3 QP	40.0	-6.7	1.50 H	17	42.7	-9.4
2	138.64	25.8 QP	43.5	-17.7	1.00 H	237	35.0	-9.2
3	159.98	24.4 QP	43.5	-19.1	2.00 H	261	33.2	-8.8
4	305.48	28.4 QP	46.0	-17.6	1.00 H	318	35.6	-7.2
5	361.74	35.2 QP	46.0	-10.8	1.50 H	333	41.0	-5.8
6	580.96	32.7 QP	46.0	-13.3	1.00 H	329	32.3	0.4

Remarks:

1. Emission Level(dBuV/m) = Raw Value(dBuV) + Correction Factor(dB/m).
2. Correction Factor(dB/m) = Antenna Factor(dB/m) + Cable Factor(dB) – Pre-Amplifier Factor(dB).
3. The other emission levels were very low against the limit of frequency range 30MHz ~ 1000MHz.
4. Margin value = Emission Level – Limit value.
5. The emission levels were very low against the limit of frequency range 9kHz ~ 30MHz: the amplitude of spurious emissions attenuated more than 20 dB below the permissible value to be report.

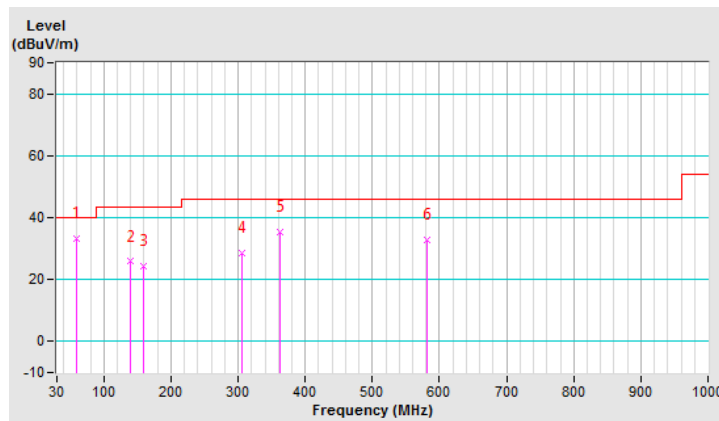

CHANNEL	TX Channel 157	DETECTOR FUNCTION	Quasi-Peak (QP)
FREQUENCY RANGE	9kHz ~ 1GHz		
TEST MODE	B		

ANTENNA POLARITY & TEST DISTANCE: VERTICAL AT 3 M								
NO.	FREQ. (MHz)	EMISSION LEVEL (dBuV/m)	LIMIT (dBuV/m)	MARGIN (dB)	ANTENNA HEIGHT (m)	TABLE ANGLE (Degree)	RAW VALUE (dBuV)	CORRECTION FACTOR (dB/m)
1	39.70	30.9 QP	40.0	-9.1	1.00 V	82	40.6	-9.7
2	103.72	35.9 QP	43.5	-7.6	1.00 V	2	48.4	-12.5
3	138.64	32.3 QP	43.5	-11.2	2.00 V	8	41.5	-9.2
4	311.30	28.7 QP	46.0	-17.3	1.00 V	172	35.7	-7.0
5	359.80	34.4 QP	46.0	-11.6	1.00 V	205	40.3	-5.9
6	499.48	35.0 QP	46.0	-11.0	1.50 V	141	36.5	-1.5

Remarks:

1. Emission Level(dBuV/m) = Raw Value(dBuV) + Correction Factor(dB/m).
2. Correction Factor(dB/m) = Antenna Factor(dB/m) + Cable Factor(dB) – Pre-Amplifier Factor(dB).
3. The other emission levels were very low against the limit of frequency range 30MHz ~ 1000MHz.
4. Margin value = Emission Level – Limit value.
5. The emission levels were very low against the limit of frequency range 9kHz ~ 30MHz: the amplitude of spurious emissions attenuated more than 20 dB below the permissible value to be report.

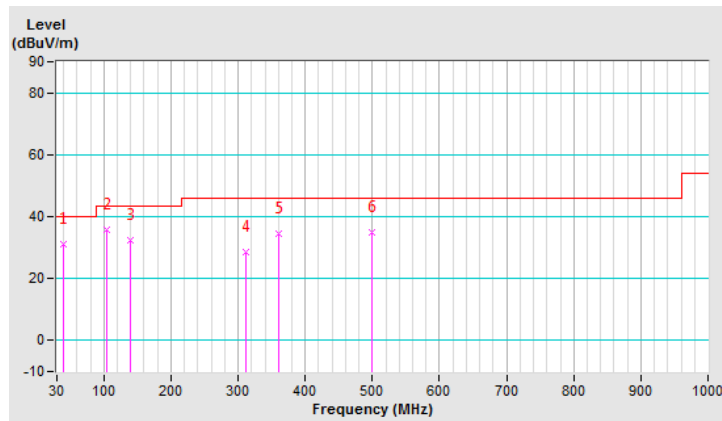

4.2 Conducted Emission Measurement

4.2.1 Limits of Conducted Emission Measurement

Frequency (MHz)	Conducted Limit (dBuV)	
	Quasi-peak	Average
0.15 - 0.5	66 - 56	56 - 46
0.50 - 5.0	56	46
5.0 - 30.0	60	50

Note: 1. The lower limit shall apply at the transition frequencies.

2. The limit decreases in line with the logarithm of the frequency in the range of 0.15 to 0.50MHz.

4.2.2 Test Instruments

Description & Manufacturer	Model No.	Serial No.	Cal. Date	Cal. Due
Test Receiver ROHDE & SCHWARZ	ESCI	100613	Dec. 10, 2018	Dec. 09, 2019
RF signal cable Woken	5D-FB	Cable-cond1-01	Sep. 05, 2019	Sep. 04, 2020
LISN ROHDE & SCHWARZ (EUT)	ENV216	101826	Feb. 21, 2019	Feb. 20, 2020
LISN ROHDE & SCHWARZ (Peripheral)	ESH3-Z5	100311	Aug. 22, 2019	Aug. 21, 2020
Software ADT	BV ADT_Cond_ V7.3.7.4	NA	NA	NA

Note: 1. The calibration interval of the above test instruments is 12 months and the calibrations are traceable to NML/ROC and NIST/USA.

2. The test was performed in HwaYa Shielded Room 1.

3. The VCCI Site Registration No. is C-12040.

4.2.3 Test Procedures

- The EUT was placed 0.4 meters from the conducting wall of the shielded room with EUT being connected to the power mains through a line impedance stabilization network (LISN). Other support units were connected to the power mains through another LISN. The two LISNs provide 50 ohm/ 50uH of coupling impedance for the measuring instrument.
- Both lines of the power mains connected to the EUT were checked for maximum conducted interference.
- The frequency range from 150kHz to 30MHz was searched. Emission levels under (Limit - 20dB) was not recorded.

Note: The resolution bandwidth and video bandwidth of test receiver is 9kHz for quasi-peak detection (QP) and average detection (AV) at frequency 0.15MHz-30MHz.

4.2.4 Deviation from Test Standard

No deviation.

4.2.5 Test Setup

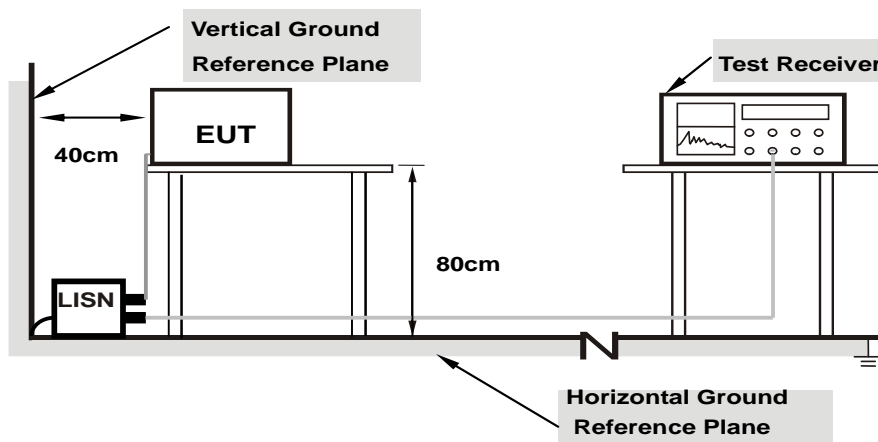

Note: 1.Support units were connected to second LISN.

For the actual test configuration, please refer to the attached file (Test Setup Photo).

4.2.6 EUT Operating Conditions

Same as 4.1.6.

4.2.7 Test Results

Worst-case data:

802.11a

Phase	Line (L)	Detector Function	Quasi-Peak (QP) / Average (AV)
Test Mode	A		

No	Freq. [MHz]	Corr. Factor (dB)	Reading Value [dB (uV)]		Emission Level [dB (uV)]		Limit [dB (uV)]		Margin (dB)	
			Q.P.	AV.	Q.P.	AV.	Q.P.	AV.	Q.P.	AV.
			1	0.15400	9.67	40.37	30.17	50.04	39.84	65.78
2	0.25000	9.67	32.41	31.18	42.08	40.85	61.76	51.76	-19.68	-10.91
3	0.34200	9.68	32.77	27.33	42.45	37.01	59.15	49.15	-16.70	-12.14
4	0.48957	9.70	36.86	35.77	46.56	45.47	56.18	46.18	-9.62	-0.71
5	0.52844	9.70	32.42	31.28	42.12	40.98	56.00	46.00	-13.88	-5.02
6	0.99400	9.73	29.85	29.72	39.58	39.45	56.00	46.00	-16.42	-6.55

Remarks:

1. Q.P. and AV. are abbreviations of quasi-peak and average individually.
2. The emission levels of other frequencies were very low against the limit.
3. Margin value = Emission level - Limit value
4. Correction factor = Insertion loss + Cable loss
5. Emission Level = Correction Factor + Reading Value.

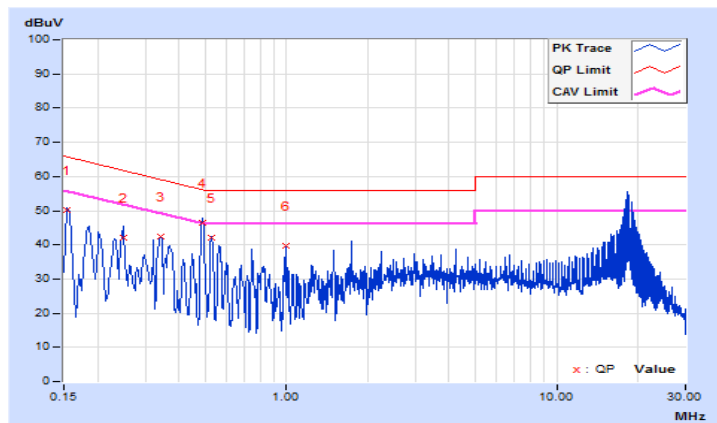

Phase	Neutral (N)	Detector Function	Quasi-Peak (QP) / Average (AV)
Test Mode	A		

No	Freq. [MHz]	Corr. Factor (dB)	Reading Value [dB (uV)]		Emission Level [dB (uV)]		Limit [dB (uV)]		Margin (dB)	
			Q.P.	AV.	Q.P.	AV.	Q.P.	AV.	Q.P.	AV.
			1	0.16600	9.64	37.54	22.44	47.18	32.08	65.16
2	0.19000	9.64	36.70	24.01	46.34	33.65	64.04	54.04	-17.70	-20.39
3	0.25000	9.65	31.76	31.16	41.41	40.81	61.76	51.76	-20.35	-10.95
4	0.48957	9.67	36.15	35.40	45.82	45.07	56.18	46.18	-10.36	-1.11
5	0.56591	9.67	29.46	28.12	39.13	37.79	56.00	46.00	-16.87	-8.21
6	1.73800	9.74	30.31	27.70	40.05	37.44	56.00	46.00	-15.95	-8.56

Remarks:

1. Q.P. and AV. are abbreviations of quasi-peak and average individually.
2. The emission levels of other frequencies were very low against the limit.
3. Margin value = Emission level - Limit value
4. Correction factor = Insertion loss + Cable loss
5. Emission Level = Correction Factor + Reading Value.

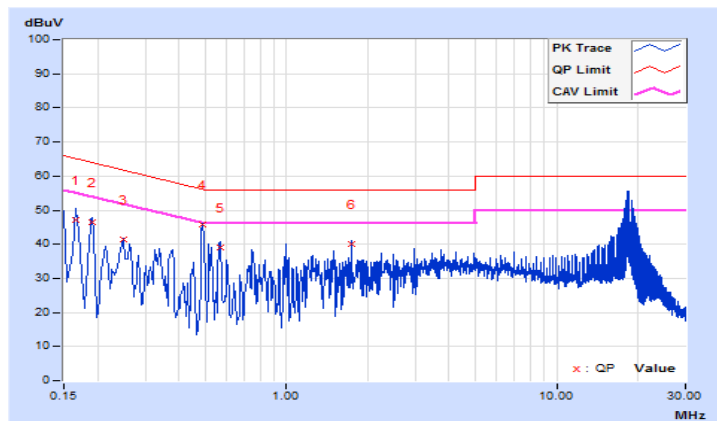

Phase	Line (L)	Detector Function	Quasi-Peak (QP) / Average (AV)
Test Mode	B		

No	Freq. [MHz]	Corr. Factor (dB)	Reading Value [dB (uV)]		Emission Level [dB (uV)]		Limit [dB (uV)]		Margin (dB)	
			Q.P.	AV.	Q.P.	AV.	Q.P.	AV.	Q.P.	AV.
			1	0.17000	9.67	34.89	20.91	44.56	30.58	64.96
2	0.24200	9.67	32.96	23.94	42.63	33.61	62.03	52.03	-19.40	-18.42
3	0.48600	9.70	36.28	36.03	45.98	45.73	56.24	46.24	-10.26	-0.51
4	0.52844	9.70	34.00	31.81	43.70	41.51	56.00	46.00	-12.30	-4.49
5	0.56740	9.70	30.34	29.16	40.04	38.86	56.00	46.00	-15.96	-7.14
6	16.27800	9.97	17.90	9.89	27.87	19.86	60.00	50.00	-32.13	-30.14

Remarks:

1. Q.P. and AV. are abbreviations of quasi-peak and average individually.
2. The emission levels of other frequencies were very low against the limit.
3. Margin value = Emission level - Limit value
4. Correction factor = Insertion loss + Cable loss
5. Emission Level = Correction Factor + Reading Value.

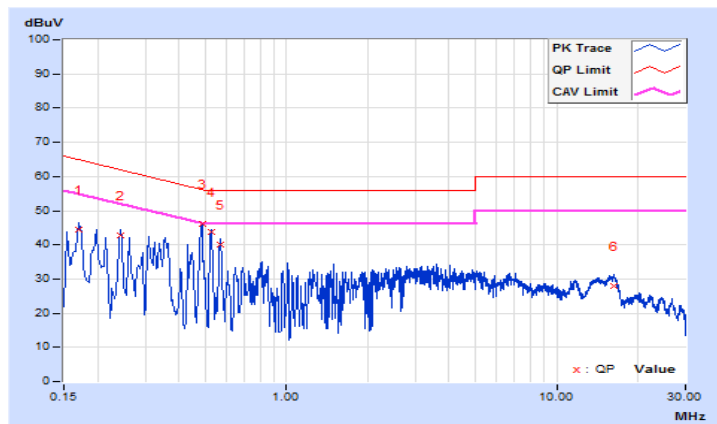

Phase	Neutral (N)	Detector Function	Quasi-Peak (QP) / Average (AV)
Test Mode	B		

No	Freq. [MHz]	Corr. Factor (dB)	Reading Value [dB (uV)]		Emission Level [dB (uV)]		Limit [dB (uV)]		Margin (dB)	
			Q.P.	AV.	Q.P.	AV.	Q.P.	AV.	Q.P.	AV.
			1	0.15000	9.64	40.56	20.15	50.20	29.79	66.00
2	0.19265	9.64	31.72	14.17	41.36	23.81	63.92	53.92	-22.56	-30.11
3	0.36600	9.66	29.79	26.28	39.45	35.94	58.59	48.59	-19.14	-12.65
4	0.48600	9.67	36.88	35.86	46.55	45.53	56.24	46.24	-9.69	-0.71
5	0.52600	9.67	30.59	29.86	40.26	39.53	56.00	46.00	-15.74	-6.47
6	6.70600	9.86	21.55	11.65	31.41	21.51	60.00	50.00	-28.59	-28.49

Remarks:

1. Q.P. and AV. are abbreviations of quasi-peak and average individually.
2. The emission levels of other frequencies were very low against the limit.
3. Margin value = Emission level - Limit value
4. Correction factor = Insertion loss + Cable loss
5. Emission Level = Correction Factor + Reading Value.

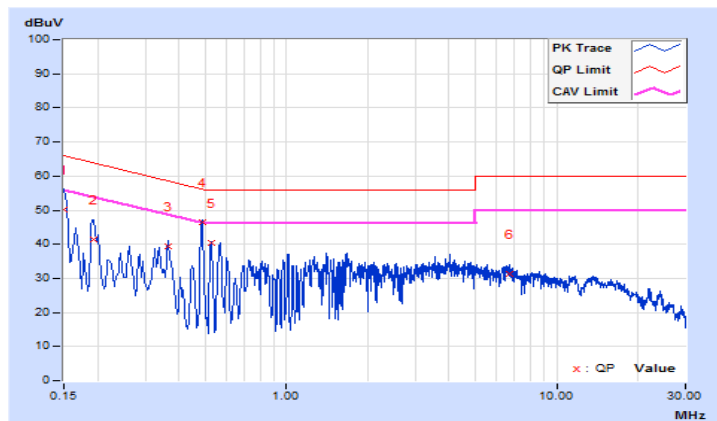

4.3 Transmit Power Measurement

4.3.1 Limits of Transmit Power Measurement

Operation Band	EUT Category		Limit
U-NII-1	√	Outdoor Access Point	1 Watt (30 dBm) (Max. e.i.r.p ≤ 125mW(21 dBm) at any elevation angle above 30 degrees as measured from the horizon)
		Fixed point-to-point Access Point	1 Watt (30 dBm)
		Indoor Access Point	1 Watt (30 dBm)
		Mobile and Portable client device	250mW (24 dBm)
U-NII-2A			250mW (24 dBm) or 11 dBm+10 log B*
U-NII-2C			250mW (24 dBm) or 11 dBm+10 log B*
U-NII-3	√		1 Watt (30 dBm)

*B is the 26 dB emission bandwidth in megahertz

Per KDB 662911 Method of conducted output power measurement on IEEE 802.11 devices,

Array Gain = 0 dB (i.e., no array gain) for $N_{ANT} \leq 4$;

Array Gain = 0 dB (i.e., no array gain) for channel widths ≥ 40 MHz for any N_{ANT} ;

Array Gain = $5 \log(N_{ANT}/N_{SS})$ dB or 3 dB, whichever is less for 20-MHz channel widths with $N_{ANT} \geq 5$.

For power measurements on all other devices: Array Gain = $10 \log(N_{ANT}/N_{SS})$ dB.

4.3.2 Test Setup

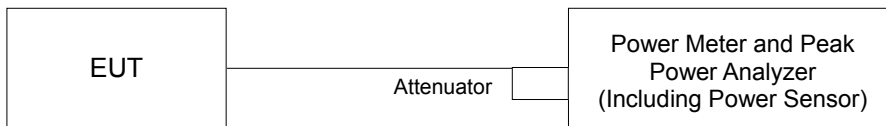

4.3.3 Test Instruments

Refer to section 4.1.2 to get information of above instrument.

4.3.4 Test Procedure

Method PM is used to perform output power measurement, trigger and gating function of wide band power meter is enabled to measure max output power of TX on burst and set the detector to average. Duty factor is not added to measured value.

4.3.5 Deviation from Test Standard

No deviation.

4.3.6 EUT Operating Conditions

The software provided by client to enable the EUT under transmission condition continuously at lowest, middle and highest channel frequencies individually.

4.3.7 Test Result

For U-NII-1 Band (Outdoor Access Point)

CDD Mode

802.11a

Chan.	Freq. (MHz)	Conducted Power (dBm)				Total Power (mW)	Total Power (dBm)	Power Limit (dBm)	Gain (dBi)	EIRP (dBm)	EIRP limit (dBm)	Pass / Fail
		Chain 0	Chain 1	Chain 2	Chain 3							
36	5180	12.17	12.94	12.19	12.33	69.819	18.44	30.00	2.10	20.54	21.00	Pass
40	5200	12.34	13.31	12.33	12.72	74.376	18.71	30.00	2.10	20.81	21.00	Pass
48	5240	12.49	13.37	11.54	12.14	70.093	18.46	30.00	2.10	20.56	21.00	Pass

Note: EIRP = conducted power + ant. gain + array gain = (0 dB (i.e., no array gain) for $N_{ANT} \leq 4$).

802.11n (HT20)

Chan.	Freq. (MHz)	Conducted Power (dBm)				Total Power (mW)	Total Power (dBm)	Power Limit (dBm)	Gain (dBi)	EIRP (dBm)	EIRP limit (dBm)	Pass / Fail
		Chain 0	Chain 1	Chain 2	Chain 3							
36	5180	12.03	12.92	12.13	12.38	69.176	18.40	30.00	2.10	20.50	21.00	Pass
40	5200	12.25	13.46	12.45	12.77	75.472	18.78	30.00	2.10	20.88	21.00	Pass
48	5240	12.58	13.68	11.51	12.40	72.984	18.63	30.00	2.10	20.73	21.00	Pass

Note: EIRP = conducted power + ant. gain + array gain = (0 dB (i.e., no array gain) for $N_{ANT} \leq 4$).

802.11n (HT40)

Chan.	Freq. (MHz)	Conducted Power (dBm)				Total Power (mW)	Total Power (dBm)	Power Limit (dBm)	Gain (dBi)	EIRP (dBm)	EIRP limit (dBm)	Pass / Fail
		Chain 0	Chain 1	Chain 2	Chain 3							
38	5190	12.08	13.31	12.01	12.40	70.836	18.50	30.00	2.10	20.60	21.00	Pass
46	5230	12.35	13.31	11.71	12.35	70.612	18.49	30.00	2.10	20.59	21.00	Pass

Note: EIRP = conducted power + ant. gain + array gain = (0 dB (i.e., no array gain) for $N_{ANT} \leq 4$).

802.11ac (VHT80)

Chan.	Freq. (MHz)	Conducted Power (dBm)				Total Power (mW)	Total Power (dBm)	Power Limit (dBm)	Gain (dBi)	EIRP (dBm)	EIRP limit (dBm)	Pass / Fail
		Chain 0	Chain 1	Chain 2	Chain 3							
42	5210	12.25	13.26	12.01	12.33	70.957	18.51	30.00	2.10	20.61	21.00	Pass

Note: EIRP = conducted power + ant. gain + array gain = (0 dB (i.e., no array gain) for $N_{ANT} \leq 4$).

Beamforming Mode

802.11n (HT20)

Chan.	Freq. (MHz)	Conducted Power (dBm)				Total Power (mW)	Total Power (dBm)	Power Limit (dBm)	Gain (dBi)	EIRP (dBm)	EIRP limit (dBm)	Pass / Fail
		Chain 0	Chain 1	Chain 2	Chain 3							
36	5180	6.01	6.90	6.11	6.36	17.296	12.38	27.88	8.12	20.50	21.00	Pass
40	5200	6.23	7.44	6.43	6.75	18.871	12.76	27.88	8.12	20.88	21.00	Pass
48	5240	6.56	7.66	5.49	6.38	18.248	12.61	27.88	8.12	20.73	21.00	Pass

Note:

1. Directional Gain = $2.1\text{dBi} + 10\log(4) = 8.12\text{dBi} > 6\text{dBi}$, so the limit shall be reduced to $30 - (8.12 - 6) = 27.88\text{dBm}$.
2. EIRP = conducted power + directional gain + array gain = (0 dB (i.e., no array gain) for $N_{\text{ANT}} \leq 4$).

802.11n (HT40)

Chan.	Freq. (MHz)	Conducted Power (dBm)				Total Power (mW)	Total Power (dBm)	Power Limit (dBm)	Gain (dBi)	EIRP (dBm)	EIRP limit (dBm)	Pass / Fail
		Chain 0	Chain 1	Chain 2	Chain 3							
38	5190	6.06	7.29	5.99	6.38	17.711	12.48	27.88	8.12	20.60	21.00	Pass
46	5230	6.33	7.29	5.69	6.33	17.655	12.47	27.88	8.12	20.59	21.00	Pass

Note:

1. Directional Gain = $2.1\text{dBi} + 10\log(4) = 8.12\text{dBi} > 6\text{dBi}$, so the limit shall be reduced to $30 - (8.12 - 6) = 27.88\text{dBm}$.
2. EIRP = conducted power + directional gain + array gain = (0 dB (i.e., no array gain) for $N_{\text{ANT}} \leq 4$).

802.11ac (VHT80)

Chan.	Freq. (MHz)	Conducted Power (dBm)				Total Power (mW)	Total Power (dBm)	Power Limit (dBm)	Gain (dBi)	EIRP (dBm)	EIRP limit (dBm)	Pass / Fail
		Chain 0	Chain 1	Chain 2	Chain 3							
42	5210	6.23	7.24	5.99	6.31	17.743	12.49	27.88	8.12	20.61	21.00	Pass

Note:

1. Directional Gain = $2.1\text{dBi} + 10\log(4) = 8.12\text{dBi} > 6\text{dBi}$, so the limit shall be reduced to $30 - (8.12 - 6) = 27.88\text{dBm}$.
2. EIRP = conducted power + directional gain + array gain = (0 dB (i.e., no array gain) for $N_{\text{ANT}} \leq 4$).

For U-NII-3 band

CDD Mode

802.11a

Chan.	Freq. (MHz)	Maximum Conducted Power (dBm)				Total Power (mW)	Total Power (dBm)	Power Limit (dBm)	Pass / Fail
		Chain 0	Chain 1	Chain 2	Chain 3				
149	5745	20.11	19.63	18.63	18.91	345.148	25.38	30.00	Pass
157	5785	21.13	21.03	19.03	19.89	433.965	26.37	30.00	Pass
165	5825	20.15	20.03	19.58	19.77	389.831	25.91	30.00	Pass

802.11n (HT20)

Chan.	Freq. (MHz)	Maximum Conducted Power (dBm)				Total Power (mW)	Total Power (dBm)	Power Limit (dBm)	Pass / Fail
		Chain 0	Chain 1	Chain 2	Chain 3				
149	5745	19.78	19.44	17.77	18.59	315.080	24.98	30.00	Pass
157	5785	20.15	20.09	18.56	19.49	366.307	25.64	30.00	Pass
165	5825	19.93	19.72	18.23	19.82	354.624	25.50	30.00	Pass

802.11n (HT40)

Chan.	Freq. (MHz)	Maximum Conducted Power (dBm)				Total Power (mW)	Total Power (dBm)	Power Limit (dBm)	Pass / Fail
		Chain 0	Chain 1	Chain 2	Chain 3				
151	5755	20.63	20.49	18.93	19.55	395.875	25.98	30.00	Pass
159	5795	20.19	19.88	18.61	19.59	365.349	25.63	30.00	Pass

802.11ac (VHT80)

Chan.	Freq. (MHz)	Maximum Conducted Power (dBm)				Total Power (mW)	Total Power (dBm)	Power Limit (dBm)	Pass / Fail
		Chain 0	Chain 1	Chain 2	Chain 3				
155	5775	17.77	17.61	15.95	16.66	203.218	23.08	30.00	Pass

Beamforming Mode

802.11n (HT20)

Chan.	Freq. (MHz)	Maximum Conducted Power (dBm)				Total Power (mW)	Total Power (dBm)	Power Limit (dBm)	Pass / Fail
		Chain 0	Chain 1	Chain 2	Chain 3				
149	5745	13.76	13.42	11.75	12.57	78.781	18.96	27.88	Pass
157	5785	14.13	14.07	12.54	13.47	91.589	19.62	27.88	Pass
165	5825	13.91	13.70	12.21	13.80	88.668	19.48	27.88	Pass

Note: Directional Gain = 2.1dBi + 10log(4) = 8.12dBi > 6dBi, so the limit shall be reduced to 30-(8.12-6) = 27.88dBm.

802.11n (HT40)

Chan.	Freq. (MHz)	Maximum Conducted Power (dBm)				Total Power (mW)	Total Power (dBm)	Power Limit (dBm)	Pass / Fail
		Chain 0	Chain 1	Chain 2	Chain 3				
151	5755	14.61	14.47	12.91	13.53	98.982	19.96	27.88	Pass
159	5795	14.17	13.86	12.59	13.57	91.350	19.61	27.88	Pass

Note: Directional Gain = 2.1dBi + 10log(4) = 8.12dBi > 6dBi, so the limit shall be reduced to 30-(8.12-6) = 27.88dBm.

802.11ac (VHT80)

Chan.	Freq. (MHz)	Maximum Conducted Power (dBm)				Total Power (mW)	Total Power (dBm)	Power Limit (dBm)	Pass / Fail
		Chain 0	Chain 1	Chain 2	Chain 3				
155	5775	11.75	11.59	9.93	10.64	50.811	17.06	27.88	Pass

Note: Directional Gain = 2.1dBi + 10log(4) = 8.12dBi > 6dBi, so the limit shall be reduced to 30-(8.12-6) = 27.88dBm.

4.4 Occupied Bandwidth Measurement

4.4.1 Test Setup

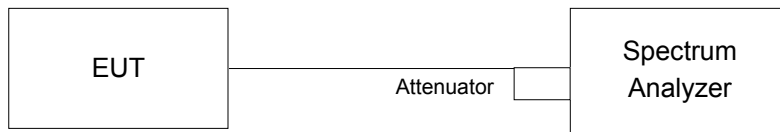

4.4.2 Test Instruments

Refer to section 4.1.2 to get information of above instrument.

4.4.3 Test Procedure

The transmitter output was connected to the spectrum analyzer through an attenuator. The bandwidth of the fundamental frequency was measured by spectrum analyzer with resolution bandwidth in the range of 1% to 5% of the anticipated emission bandwidth, and a video bandwidth at least 3x the resolution bandwidth and set the detector to sampling. The width of a frequency band such that, below the lower and above the upper frequency limits, the mean powers emitted are each equal to a specified percentage 0.5 %of the total mean power of a given emission.

4.4.4 Test Result

802.11a

Chan.	Freq. (MHz)	Occupied Bandwidth (MHz)			
		Chain 0	Chain 1	Chain 2	Chain 3
36	5180	16.43	16.43	16.52	16.43
40	5200	16.44	16.44	16.56	16.44
48	5240	16.44	16.44	16.44	16.44
149	5745	16.44	16.44	16.44	16.56
157	5785	16.68	16.92	26.76	16.68
165	5825	17.04	17.04	26.52	16.68

802.11n (HT20)

Chan.	Freq. (MHz)	Occupied Bandwidth (MHz)			
		Chain 0	Chain 1	Chain 2	Chain 3
36	5180	17.64	17.64	17.64	17.64
40	5200	17.64	17.64	17.64	17.64
48	5240	17.64	17.64	17.64	17.64
149	5745	17.64	17.64	17.64	17.64
157	5785	17.64	17.88	24.60	17.76
165	5825	18.00	17.88	26.64	17.76

802.11n (HT40)

Chan.	Freq. (MHz)	Occupied Bandwidth (MHz)			
		Chain 0	Chain 1	Chain 2	Chain 3
38	5190	36.12	36.12	36.00	36.00
46	5230	36.12	36.12	36.00	36.00
151	5755	36.00	36.24	37.44	36.00
159	5795	36.24	36.24	39.24	36.00

802.11ac (VHT80)

Chan.	Freq. (MHz)	Occupied Bandwidth (MHz)			
		Chain 0	Chain 1	Chain 2	Chain 3
42	5210	75.84	75.84	75.84	76.08
155	5775	75.84	75.84	76.32	75.84

Spectrum Plot of Worst Value

802.11a

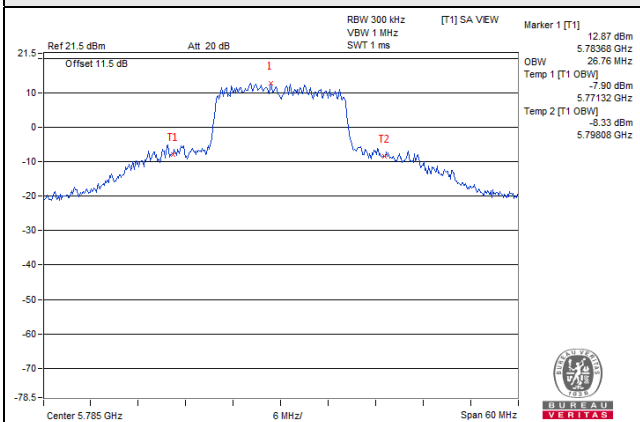

802.11n (HT20)

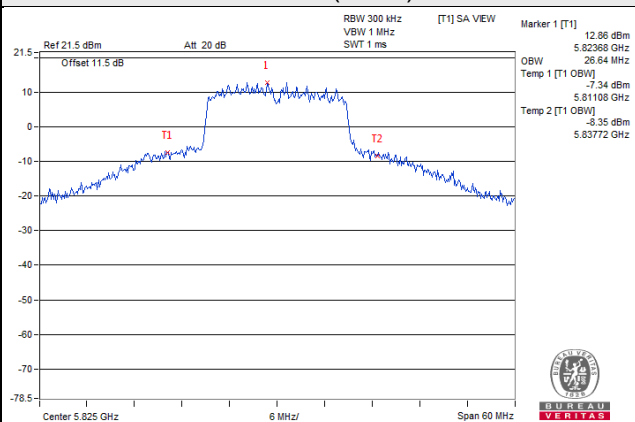

802.11n (HT40)

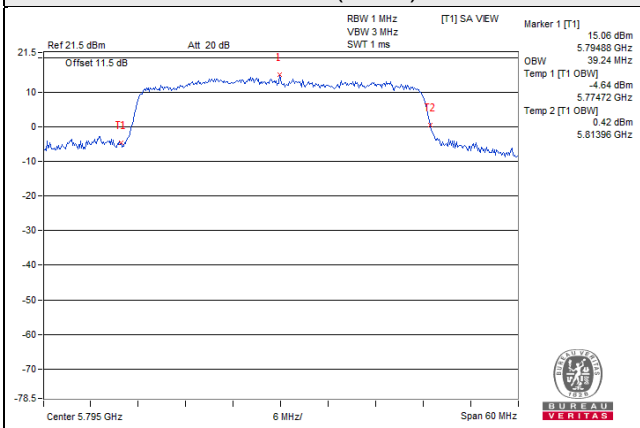

802.11ac (VHT80)

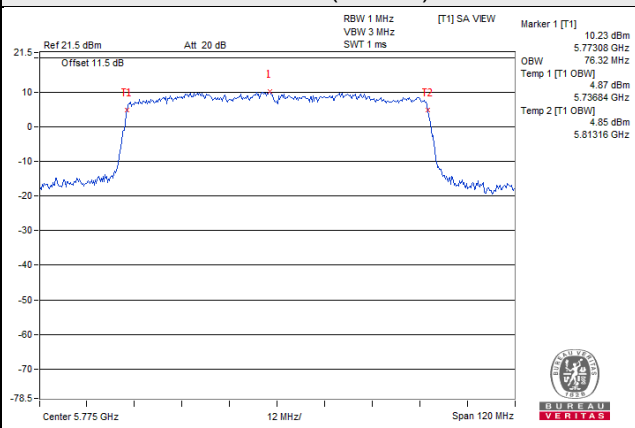

Spectrum Plot for near By DFS Band

802.11a / Chain 0 / CH 48

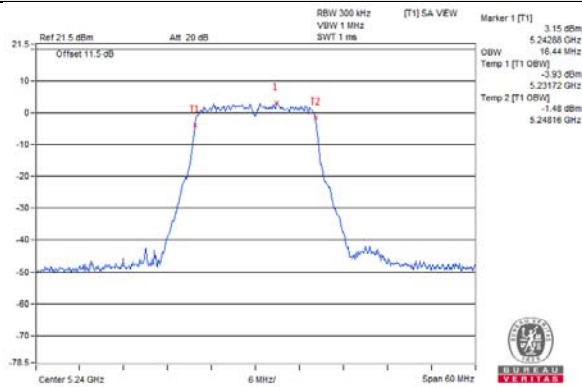

802.11a / Chain 1 / CH 48

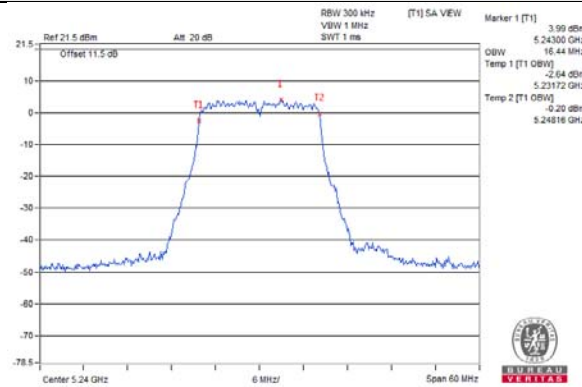

802.11a / Chain 2 / CH 48

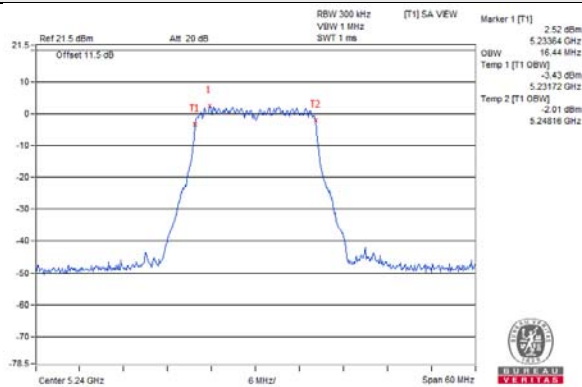

802.11a / Chain 3 / CH 48

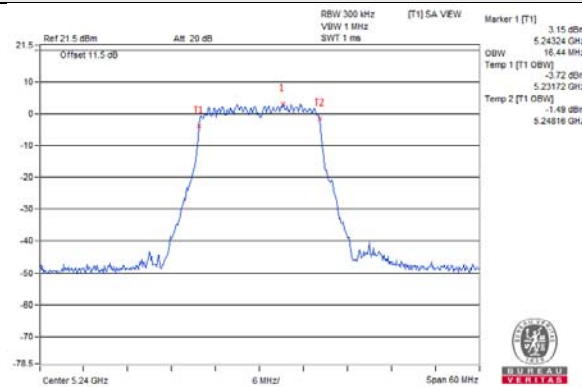

802.11n (HT20) / Chain 0 / CH 48

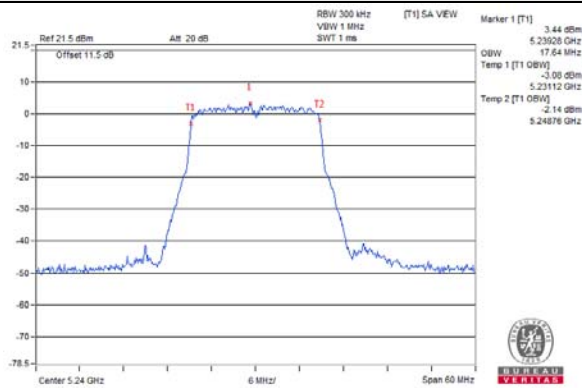

802.11n (HT20) / Chain 1 / CH 48

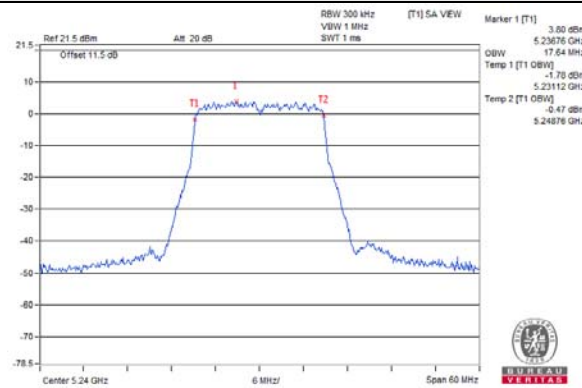

802.11n (HT20) / Chain 2 / CH 48

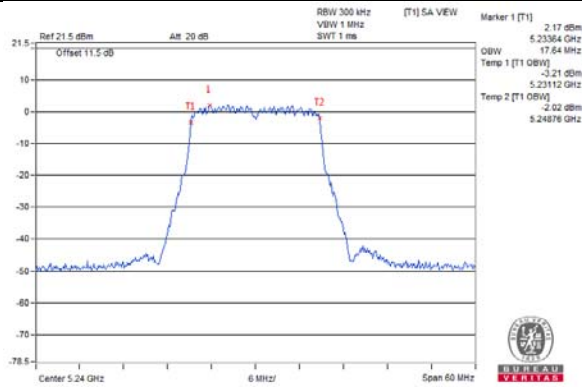

802.11n (HT20) / Chain 3 / CH 48

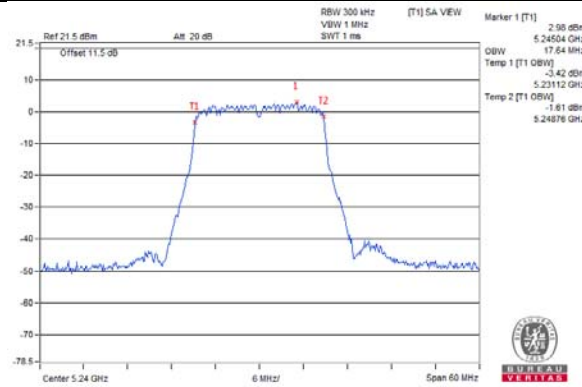

Spectrum Plot for near By DFS Band

802.11n (HT40) / Chain 0 / CH 46

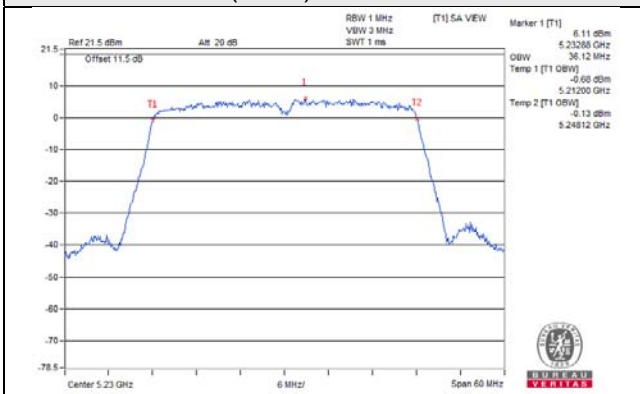

802.11n (HT40) / Chain 1 / CH 46

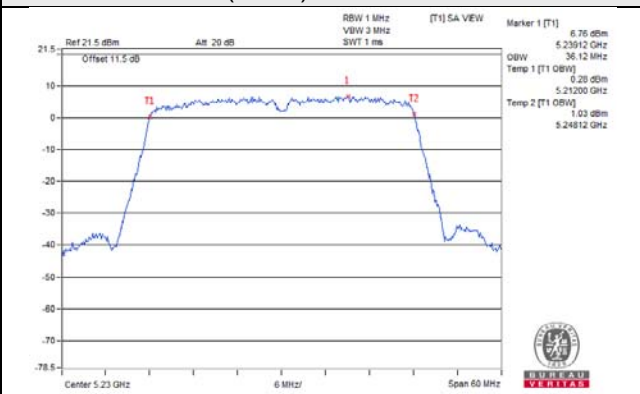

802.11n (HT40) / Chain 2 / CH 46

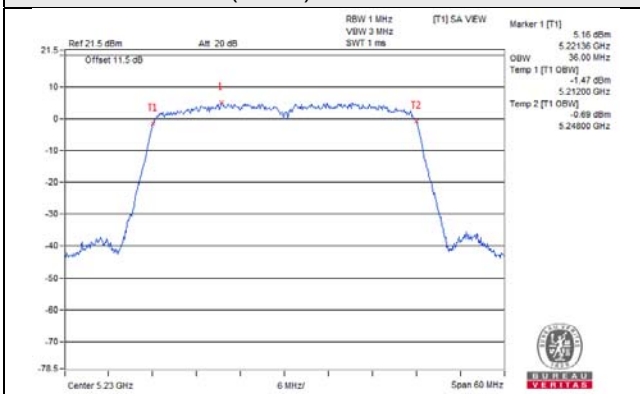

802.11n (HT40) / Chain 3 / CH 46

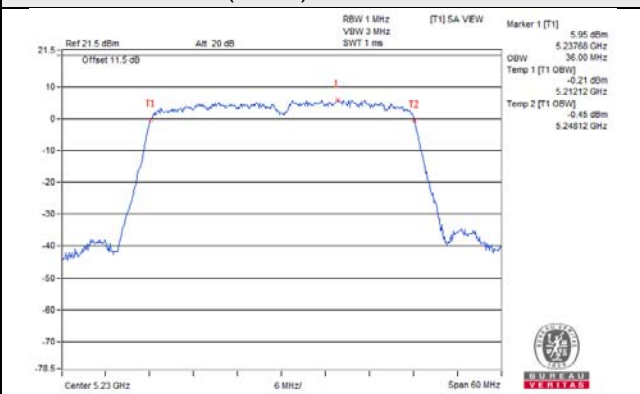

802.11ac (VHT80) / Chain 0 / CH 42

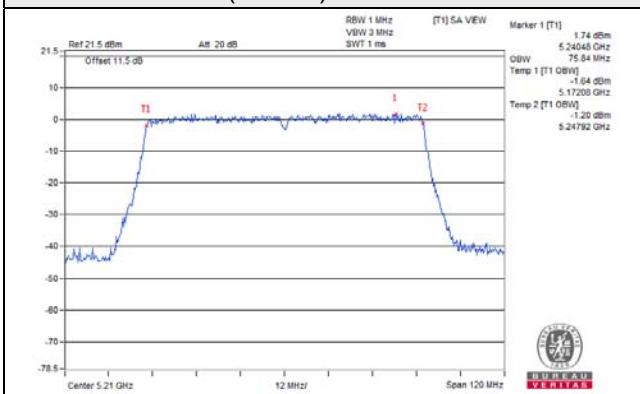

802.11ac (VHT80) / Chain 1 / CH 42

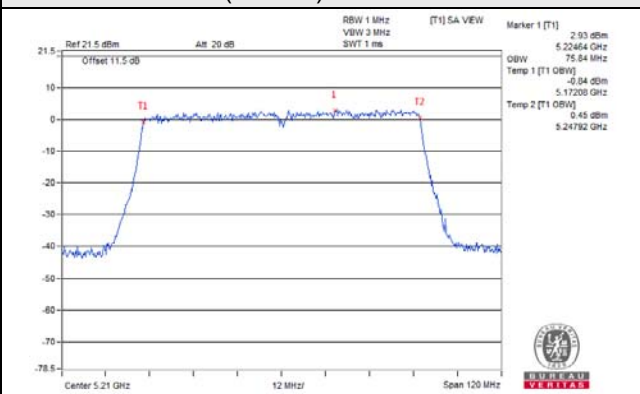

802.11ac (VHT80) / Chain 2 / CH 42

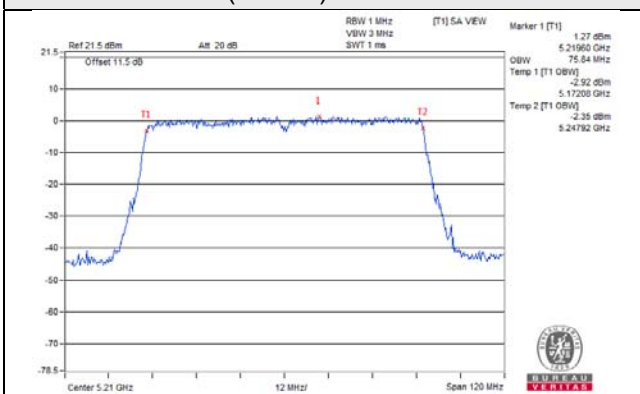

802.11ac (VHT80) / Chain 3 / CH 42

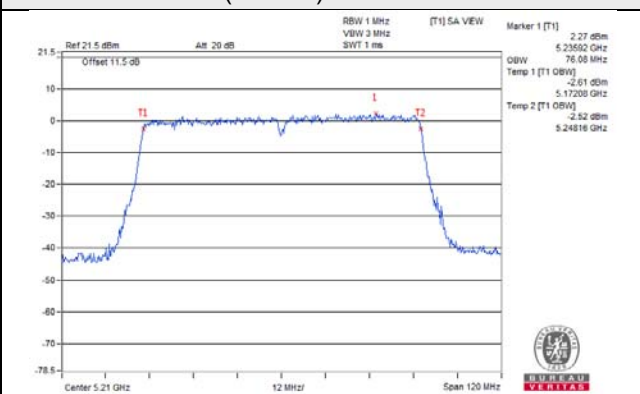

Spectrum Plot for near By DFS Band

802.11a / Chain 0 / CH 149

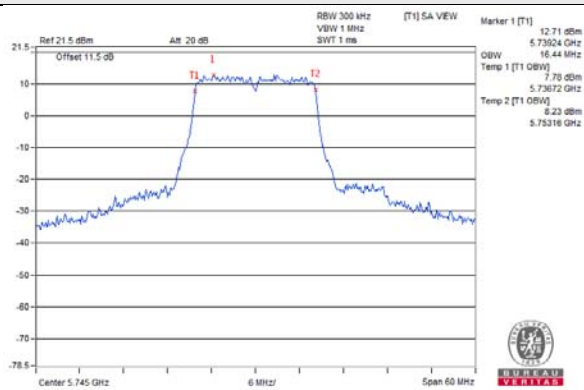

802.11a / Chain 1 / CH 149

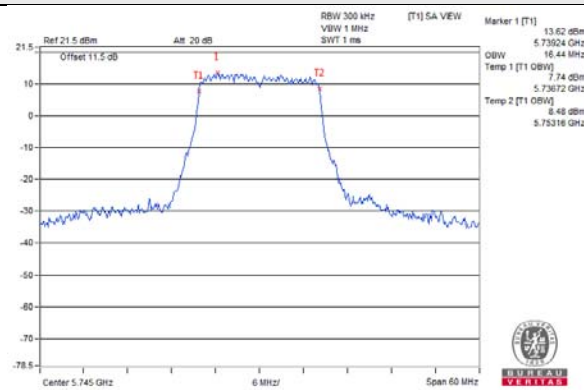

802.11a / Chain 1 / CH 149

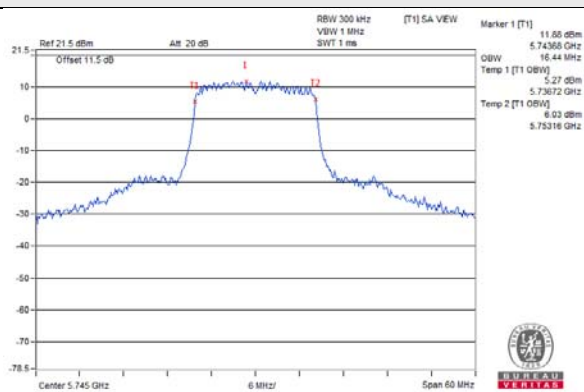

802.11a / Chain 2 / CH 149

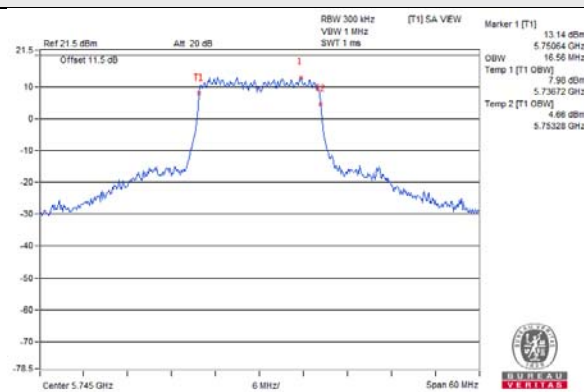

802.11n (HT20) / Chain 0 / CH 149

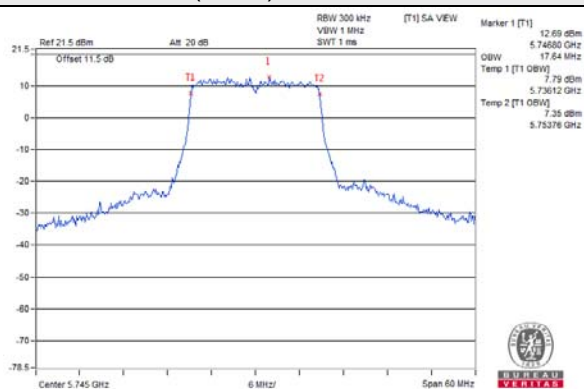

802.11n (HT20) / Chain 1 / CH 149

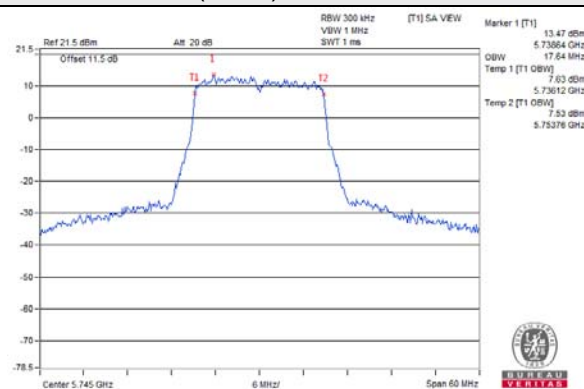

802.11n (HT20) / Chain 2 / CH 149

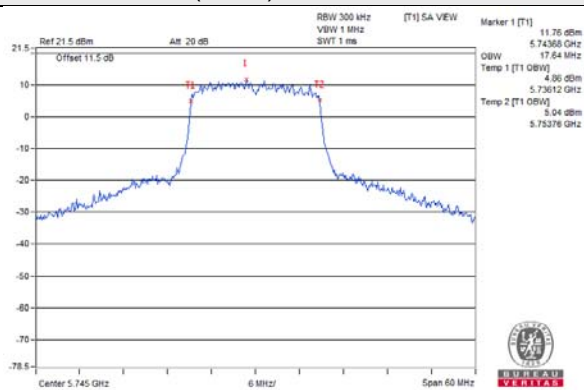

802.11n (HT20) / Chain 3 / CH 149

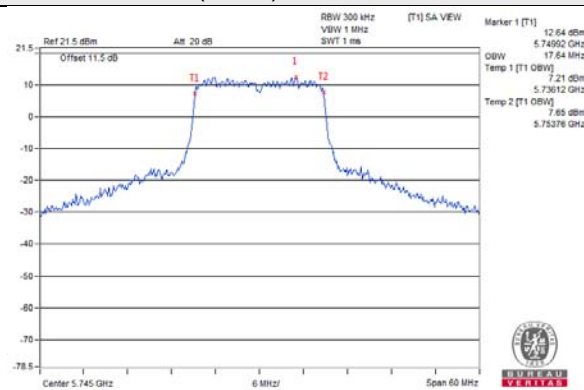

Spectrum Plot for near By DFS Band

802.11n (HT40) / Chain 0 / CH 151

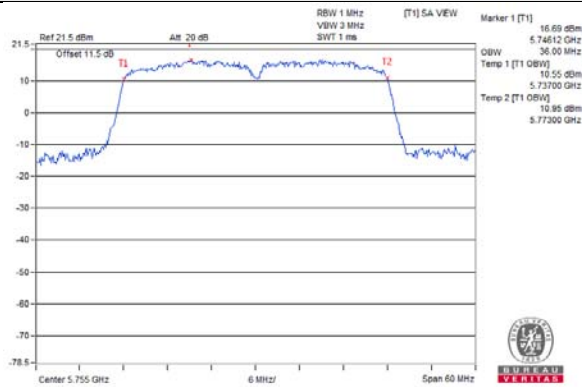

802.11n (HT40) / Chain 1 / CH 151

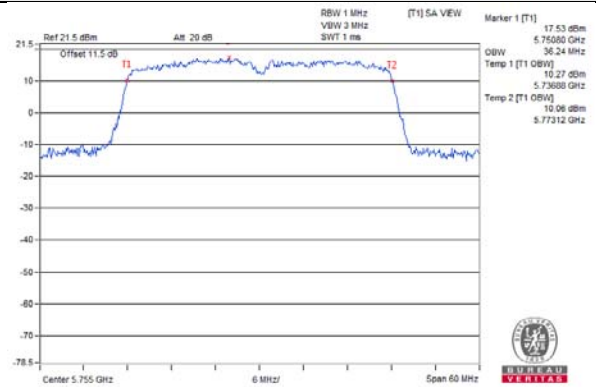

802.11n (HT40) / Chain 1 / CH 151

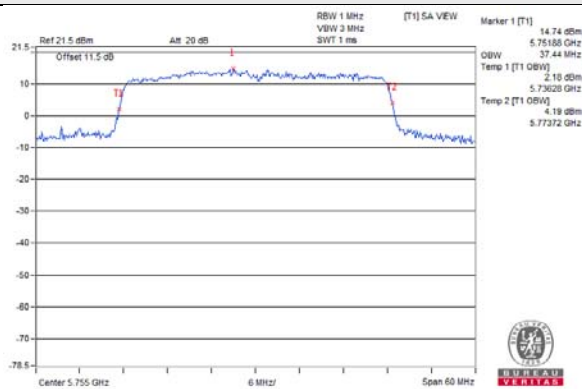

802.11n (HT40) / Chain 2 / CH 151

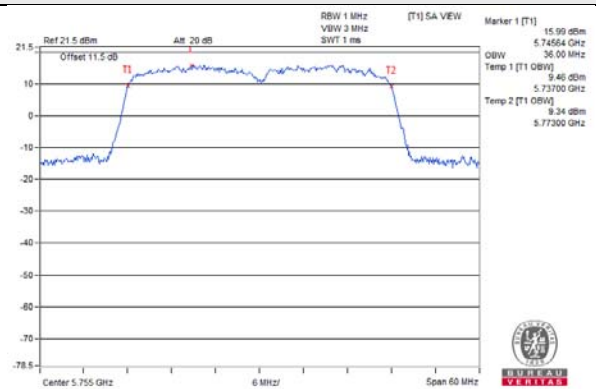

802.11ac (VHT80) / Chain 0 / CH 155

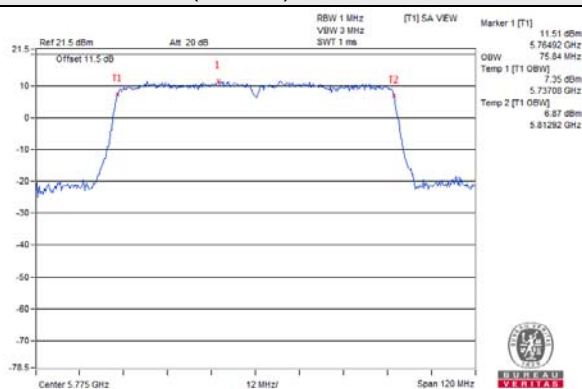

802.11ac (VHT80) / Chain 1 / CH 155

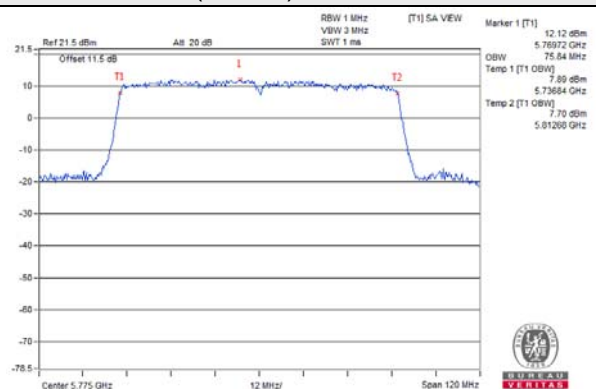

802.11ac (VHT80) / Chain 2 / CH 155

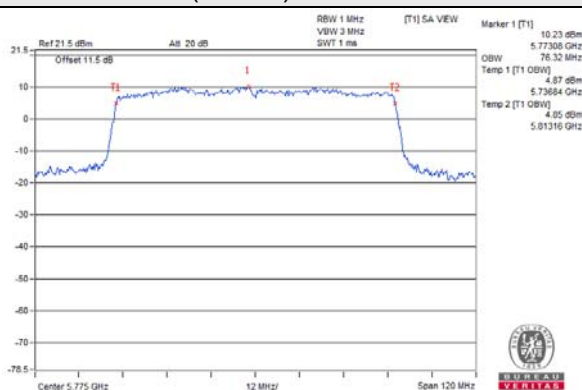

802.11ac (VHT80) / Chain 3 / CH 155

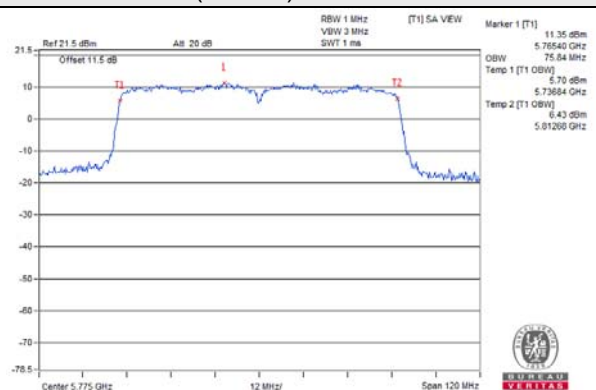

4.5 Peak Power Spectral Density Measurement

4.5.1 Limits of Peak Power Spectral Density Measurement

Operation Band	EUT Category		Limit
U-NII-1	√	Outdoor Access Point	17dBm/ MHz
		Fixed point-to-point Access Point	
		Indoor Access Point	
		Mobile and Portable client device	11dBm/ MHz
U-NII-2A			11dBm/ MHz
U-NII-2C			11dBm/ MHz
U-NII-3	√		30dBm/ 500kHz

4.5.2 Test Setup

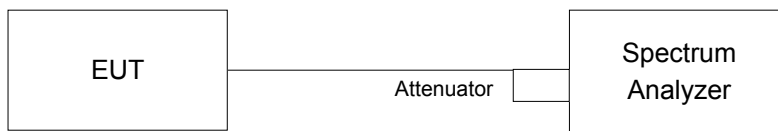

4.5.3 Test Instruments

Refer to section 4.1.2 to get information of above instrument.

4.5.4 Test Procedures

For U-NII-1 band:

Duty cycle of test signal is > 98%

Using method SA-1

- Set span to encompass the entire emission bandwidth (EBW) of the signal.
- Set RBW = 1 MHz, Set VBW ≥ 3 MHz, Detector = RMS
- Sweep time = auto, trigger set to “free run”.
- Trace average at least 100 traces in power averaging mode.
- Record the max value

Duty cycle of test signal is < 98%

Using method SA-2

- Set span to encompass the entire emission bandwidth (EBW) of the signal.
- Set RBW = 1MHz, Set VBW ≥ 3 MHz, Detector = RMS
- Set Channel power measure = 1MHz
- Sweep time = auto, trigger set to “free run”.
- Trace average at least 100 traces in power averaging mode.
- Record the max value and add 10 log (1/duty cycle)

For U-NII-3 band:

Duty cycle of test signal is > 98%

- a. Set span to encompass the entire emission bandwidth (EBW) of the signal.
- b. Set RBW = 300 kHz, Set VBW \geq 1 MHz, Detector = RMS
- c. Use the peak marker function to determine the maximum power level in any 300 kHz band segment within the fundamental EBW.
- d. Scale the observed power level to an equivalent value in 500 kHz by adjusting (reducing) the measured power by a bandwidth correction factor (BWCF) where $BWCF = 10\log(500 \text{ kHz}/300\text{kHz})$
- e. Sweep time = auto, trigger set to "free run".
- f. Trace average at least 100 traces in power averaging mode.
- g. Record the max value

Duty cycle of test signal is < 98%

- a. Set span to encompass the entire emission bandwidth (EBW) of the signal.
- b. Set RBW = 300 kHz, Set VBW \geq 1 MHz, Detector = RMS
- c. Use the peak marker function to determine the maximum power level in any 300 kHz band segment within the fundamental EBW.
- d. Scale the observed power level to an equivalent value in 500 kHz by adjusting (reducing) the measured power by a bandwidth correction factor (BWCF) where $BWCF = 10\log(500 \text{ kHz} / 300 \text{ kHz})$
- e. Sweep time = auto, trigger set to "free run".
- f. Trace average at least 100 traces in power averaging mode.
- g. Record the max value and add $10 \log (1/\text{duty cycle})$

4.5.5 Deviation from Test Standard

No deviation.

4.5.6 EUT Operating Conditions

Same as 4.3.6.

4.5.7 Test Results

For U-NII-1 band:

802.11a

Chan.	Freq. (MHz)	PSD w/o Duty Factor (dBm/MHz)				Duty Factor (dB)	Total PSD with Duty Factor (dBm/MHz)	Max. Limit (dBm/MHz)	Pass / Fail
		Chain 0	Chain 1	Chain 2	Chain 3				
36	5180	-1.80	-0.61	-2.22	-1.68	0.17	4.66	14.88	Pass
40	5200	-1.52	1.40	0.04	0.18	0.17	6.34	14.88	Pass
48	5240	-1.16	-0.53	-2.35	-1.44	0.17	4.87	14.88	Pass

Note:

- Method E) 2) a) of power density measurement of KDB 662911 is using for calculating total power density. Total power density is summing entire spectra across corresponding frequency bins on the various outputs by computer.
- Directional Gain = $2.1\text{dBi} + 10\log(4) = 8.12\text{dBi} > 6\text{dBi}$, so the limit shall be reduced to $17-(8.12-6) = 14.88\text{dBm}$.

802.11n (HT20)

Chan.	Freq. (MHz)	PSD (dBm/MHz)				Total PSD (dBm/MHz)	Max. Limit (dBm/MHz)	Pass / Fail
		Chain 0	Chain 1	Chain 2	Chain 3			
36	5180	-1.82	-0.75	-2.32	-1.93	4.36	14.88	Pass
40	5200	-1.62	-0.65	-1.90	-1.83	4.55	14.88	Pass
48	5240	-1.35	-0.63	-2.51	-1.69	4.53	14.88	Pass

Note:

- Method E) 2) a) of power density measurement of KDB 662911 is using for calculating total power density. Total power density is summing entire spectra across corresponding frequency bins on the various outputs by computer.
- Directional Gain = $2.1\text{dBi} + 10\log(4) = 8.12\text{dBi} > 6\text{dBi}$, so the limit shall be reduced to $17-(8.12-6) = 14.88\text{dBm}$.
- Refer to section 3.3 for duty cycle spectrum plot.

802.11n (HT40)

Chan.	Freq. (MHz)	PSD w/o Duty Factor (dBm/MHz)				Duty Factor (dB)	Total PSD with Duty Factor (dBm/MHz)	Max. Limit (dBm/MHz)	Pass / Fail
		Chain 0	Chain 1	Chain 2	Chain 3				
38	5190	-4.62	-3.43	-5.10	-4.79	0.17	1.75	14.88	Pass
46	5230	-4.45	-3.41	-5.26	-4.66	0.17	1.80	14.88	Pass

Note:

- Method E) 2) a) of power density measurement of KDB 662911 is using for calculating total power density. Total power density is summing entire spectra across corresponding frequency bins on the various outputs by computer.
- Directional Gain = $2.1\text{dBi} + 10\log(4) = 8.12\text{dBi} > 6\text{dBi}$, so the limit shall be reduced to $17-(8.12-6) = 14.88\text{dBm}$.
- Refer to section 3.3 for duty cycle spectrum plot.

802.11ac (VHT80)

Chan.	Freq. (MHz)	PSD w/o Duty Factor (dBm/MHz)				Duty Factor (dB)	Total PSD with Duty Factor (dBm/MHz)	Max. Limit (dBm/MHz)	Pass / Fail
		Chain 0	Chain 1	Chain 2	Chain 3				
42	5210	-8.25	-6.90	-9.03	-8.45	0.30	-1.76	14.88	Pass

Note:

- Method E) 2) a) of power density measurement of KDB 662911 is using for calculating total power density. Total power density is summing entire spectra across corresponding frequency bins on the various outputs by computer.
- Directional Gain = 2.1dBi + 10log(4) = 8.12dBi > 6dBi, so the limit shall be reduced to 17-(8.12-6) = 14.88dBm.
- Refer to section 3.3 for duty cycle spectrum plot.

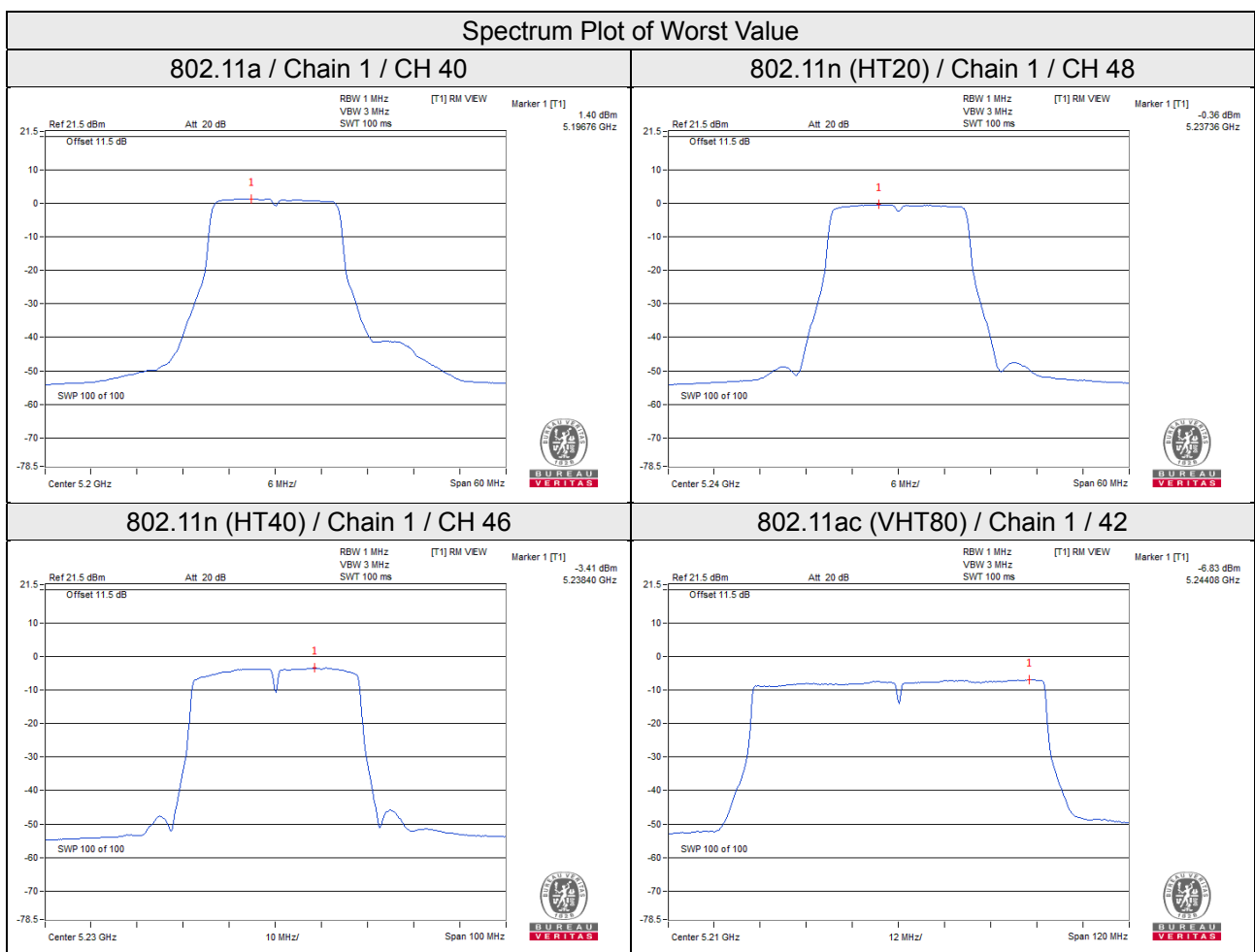

For U-NII-3 band:

802.11a

TX chain	Chan.	Freq. (MHz)	PSD w/o Duty Factor		10 log (N=4) dB	Duty Factor (dB)	Total PSD with Duty Factor (dBm/500kHz)	Limit (dBm/500 kHz)	Pass / Fail
			(dBm/300kHz)	(dBm/500kHz)					
0	149	5745	0.28	2.50	6.02	0.17	8.69	27.88	Pass
	157	5785	1.25	3.47	6.02	0.17	9.66	27.88	Pass
	165	5825	1.68	3.90	6.02	0.17	10.09	27.88	Pass
1	149	5745	0.75	2.97	6.02	0.17	9.16	27.88	Pass
	157	5785	1.80	4.02	6.02	0.17	10.21	27.88	Pass
	165	5825	1.60	3.82	6.02	0.17	10.01	27.88	Pass
2	149	5745	-1.01	1.21	6.02	0.17	7.40	27.88	Pass
	157	5785	-0.48	1.74	6.02	0.17	7.93	27.88	Pass
	165	5825	-0.53	1.69	6.02	0.17	7.88	27.88	Pass
3	149	5745	-0.20	2.02	6.02	0.17	8.21	27.88	Pass
	157	5785	0.45	2.67	6.02	0.17	8.86	27.88	Pass
	165	5825	0.62	2.84	6.02	0.17	9.03	27.88	Pass

Note:

1. Method E) 2) c) of power density measurement of KDB 662911 is using for calculating total power density, Measure and add $10 \log (N_{ANT})$ dB.
2. Directional Gain = $2.1\text{dBi} + 10\log(4) = 8.12\text{dBi} > 6\text{dBi}$, so the limit shall be reduced to $30 - (8.12 - 6) = 27.88\text{dBm}$.
3. Refer to section 3.3 for duty cycle spectrum plot.

802.11n (HT20)

TX chain	Chan.	Freq. (MHz)	PSD (dBm/300 kHz)	PSD (dBm/500 kHz)	10 log (N=4) dB	Total PSD (dBm/500 kHz)	Limit (dBm/500 kHz)	Pass / Fail
0	149	5745	-0.09	2.13	6.02	8.15	27.88	Pass
	157	5785	0.97	3.19	6.02	9.21	27.88	Pass
	165	5825	1.48	3.70	6.02	9.72	27.88	Pass
1	149	5745	0.60	2.82	6.02	8.84	27.88	Pass
	157	5785	1.33	3.55	6.02	9.57	27.88	Pass
	165	5825	1.24	3.46	6.02	9.48	27.88	Pass
2	149	5745	-1.43	0.79	6.02	6.81	27.88	Pass
	157	5785	-0.99	1.23	6.02	7.25	27.88	Pass
	165	5825	-0.90	1.32	6.02	7.34	27.88	Pass
3	149	5745	-0.48	1.74	6.02	7.76	27.88	Pass
	157	5785	0.31	2.53	6.02	8.55	27.88	Pass
	165	5825	0.59	2.81	6.02	8.83	27.88	Pass

Note:

- Method E) 2) c) of power density measurement of KDB 662911 is using for calculating total power density, Measure and add $10 \log (N_{ANT})$ dB.
- Directional Gain = $2.1\text{dBi} + 10\log(4) = 8.12\text{dBi} > 6\text{dBi}$, so the limit shall be reduced to $30-(8.12-6) = 27.88\text{dBm}$.

802.11n (HT40)

TX chain	Chan.	Freq. (MHz)	PSD W/O Duty Factor		10 log (N=4) dB	Duty Factor (dB)	Total PSD With Duty Factor (dBm/500kHz)	Limit (dBm/500kHz)	Pass / Fail
			(dBm/300kHz)	(dBm/500kHz)					
0	151	5755	-2.21	0.01	6.02	0.17	6.20	27.88	Pass
	159	5795	-1.97	0.25	6.02	0.17	6.44	27.88	Pass
1	151	5755	-1.79	0.43	6.02	0.17	6.62	27.88	Pass
	159	5795	-1.80	0.42	6.02	0.17	6.61	27.88	Pass
2	151	5755	-4.15	-1.93	6.02	0.17	4.26	27.88	Pass
	159	5795	-1.86	0.36	6.02	0.17	6.55	27.88	Pass
3	151	5755	-2.96	-0.74	6.02	0.17	5.45	27.88	Pass
	159	5795	-3.00	-0.78	6.02	0.17	5.41	27.88	Pass

Note:

- Method E) 2) c) of power density measurement of KDB 662911 is using for calculating total power density, Measure and add $10 \log (N_{ANT})$ dB.
- Directional Gain = $2.1\text{dBi} + 10\log(4) = 8.12\text{dBi} > 6\text{dBi}$, so the limit shall be reduced to $30-(8.12-6) = 27.88\text{dBm}$.
- Refer to section 3.3 for duty cycle spectrum plot.

802.11ac (VHT80)

TX chain	Chan.	Freq. (MHz)	PSD W/O Duty Factor		10 log (N=4) dB	Duty Factor (dB)	Total PSD With Duty Factor (dBm/500kHz)	Limit (dBm/500kHz)	Pass / Fail
			(dBm/300kHz)	(dBm/500kHz)					
0	155	5775	-7.53	-5.31	6.02	0.30	1.01	27.88	Pass
1	155	5775	-6.86	-4.64	6.02	0.30	1.68	27.88	Pass
2	155	5775	-7.60	-5.38	6.02	0.30	0.94	27.88	Pass
3	155	5775	-8.00	-5.78	6.02	0.30	0.54	27.88	Pass

Note:

- Method E) 2) c) of power density measurement of KDB 662911 is using for calculating total power density, Measure and add 10 log (N_{ANT}) dB.
- Directional Gain = 2.1dBi + 10log(4) = 8.12dBi > 6dBi, so the limit shall be reduced to 30-(8.12-6) = 27.88dBm.
- Refer to section 3.3 for duty cycle spectrum plot.

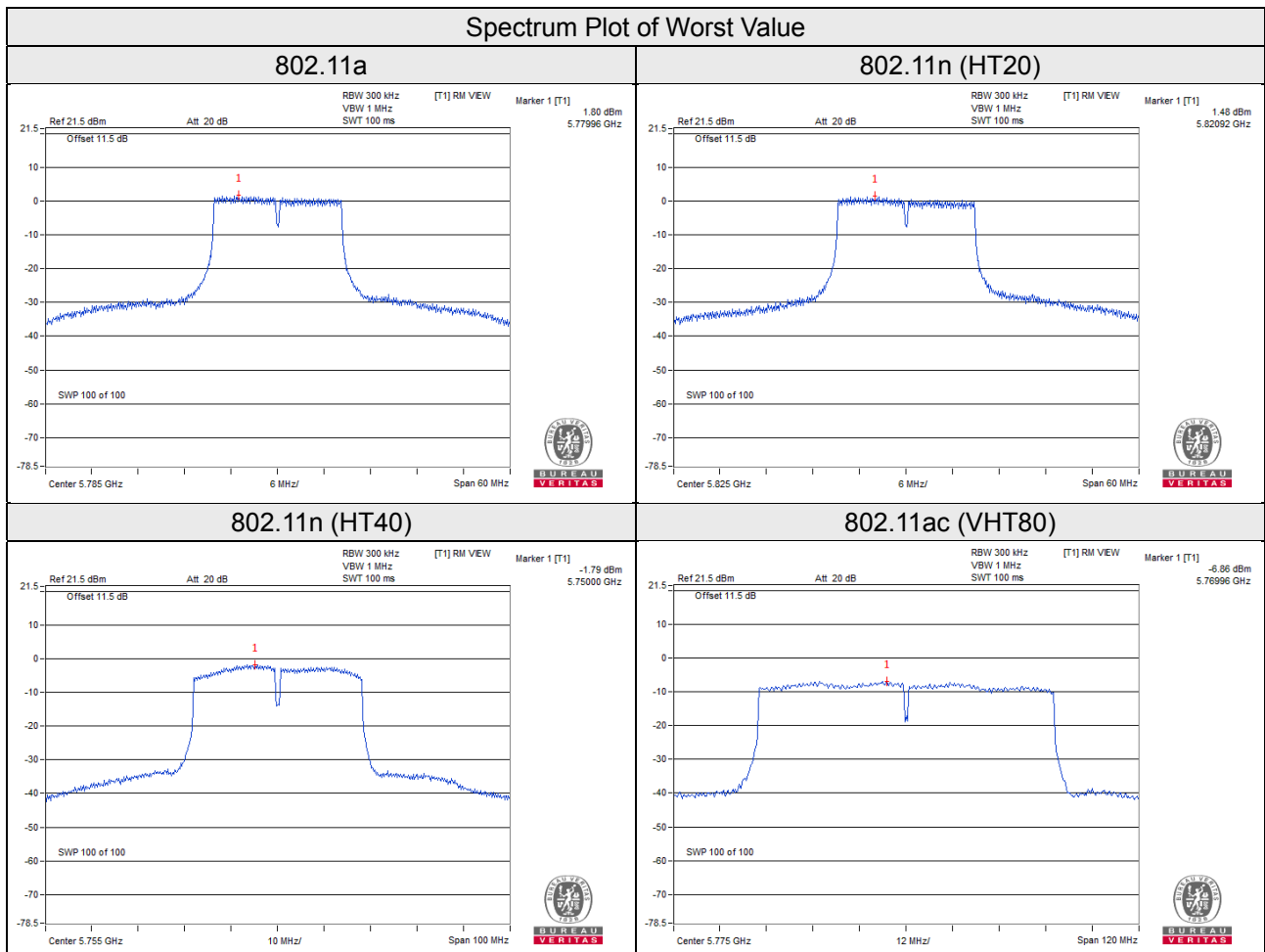

4.6 Frequency Stability

4.6.1 Limits of Frequency Stability Measurement

The frequency of the carrier signal shall be maintained within band of operation

4.6.2 Test Setup

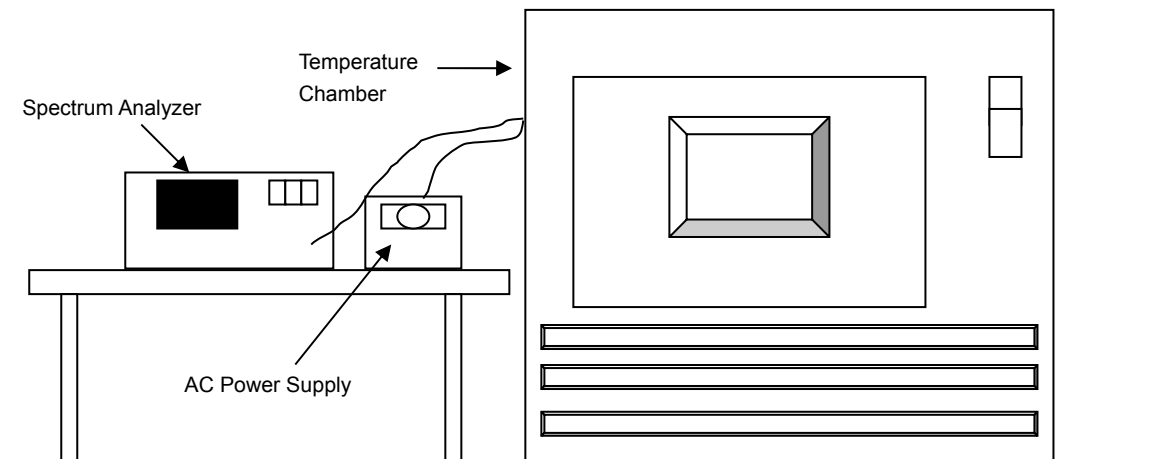

4.6.3 Test Instruments

Description & Manufacturer	Model No.	Serial No.	Cal. Date	Cal. Due
Spectrum Analyzer ROHDE & SCHWARZ	FSP40	100040	Sep. 23, 2019	Sep. 22, 2020
WIT Standard Temperature And Humidity Chamber	TH-4S-C	W981030	Jun. 03, 2019	Jun. 02, 2020
Digital Multimeter Fluke	87-III	70360742	Jun. 28, 2019	Jun. 27, 2020
AC Power Supply Extech	CFW-105	E000603	NA	NA
True RMS Clamp Meter Fluke	325	31130711WS	May 21, 2019	May 20, 2020

Note: 1. The calibration interval of the above test instruments is 12 months and the calibrations are traceable to NML/ROC and NIST/USA.

4.6.4 Test Procedure

- The EUT was placed inside the environmental test chamber and powered by nominal AC voltage.
- Turn the EUT on and couple its output to a spectrum analyzer.
- Turn the EUT off and set the chamber to the highest temperature specified.
- Allow sufficient time (approximately 30 min) for the temperature of the chamber to stabilize, turn the EUT on and measure the operating frequency after 2, 5, and 10 minutes.
- Repeat step c and d with every 10 degrees reduction until the lowest temperature achieved.
- The test chamber was allowed to stabilize at +20 degree C for a minimum of 30 minutes. The supply voltage was then adjusted on the EUT from 85% to 115% and the frequency record.

4.6.5 Deviation from Test Standard

No deviation.

4.6.6 EUT Operating Condition

Set the EUT transmit at un-modulation mode to test frequency stability.

4.6.7 Test Results

Frequency Stability Versus Temp.									
Operating Frequency: 5180MHz									
Temp. (°C)	Power Supply (Vac)	0 Minute		2 Minute		5 Minute		10 Minute	
		Measured Frequency (MHz)	Result	Measured Frequency (MHz)	Result	Measured Frequency (MHz)	Result	Measured Frequency (MHz)	Result
55	120	5180.0078	Pass	5180.0112	Pass	5180.0086	Pass	5180.0126	Pass
50	120	5180.0118	Pass	5180.0114	Pass	5180.0146	Pass	5180.0137	Pass
40	120	5179.9826	Pass	5179.9863	Pass	5179.9849	Pass	5179.9863	Pass
30	120	5179.9774	Pass	5179.9757	Pass	5179.9787	Pass	5179.9786	Pass
20	120	5179.9841	Pass	5179.9848	Pass	5179.9829	Pass	5179.9813	Pass
10	120	5179.9875	Pass	5179.991	Pass	5179.9898	Pass	5179.9908	Pass
0	120	5179.9795	Pass	5179.9777	Pass	5179.9796	Pass	5179.9805	Pass
-10	120	5179.9817	Pass	5179.9834	Pass	5179.9849	Pass	5179.9839	Pass
-20	120	5180.0132	Pass	5180.014	Pass	5180.0116	Pass	5180.0121	Pass
-30	120	5180.0206	Pass	5180.016	Pass	5180.018	Pass	5180.0164	Pass
-40	120	5180.0093	Pass	5180.0098	Pass	5180.0086	Pass	5180.0074	Pass

Frequency Stability Versus Voltage									
Operating Frequency: 5180MHz									
Temp. (°C)	Power Supply (Vac)	0 Minute		2 Minute		5 Minute		10 Minute	
		Measured Frequency (MHz)	Result	Measured Frequency (MHz)	Result	Measured Frequency (MHz)	Result	Measured Frequency (MHz)	Result
20	138	5179.9849	Pass	5179.985	Pass	5179.9821	Pass	5179.9817	Pass
	120	5179.9841	Pass	5179.9848	Pass	5179.9829	Pass	5179.9813	Pass
	102	5179.9843	Pass	5179.9846	Pass	5179.9825	Pass	5179.9823	Pass

4.7 6dB Bandwidth Measurement

4.7.1 Limits of 6dB Bandwidth Measurement

The minimum of 6dB Bandwidth Measurement is 0.5MHz.

4.7.2 Test Setup

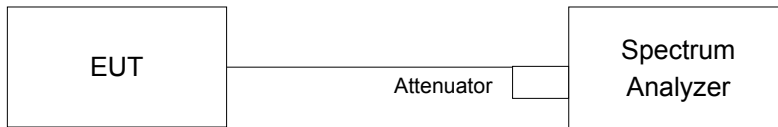

4.7.3 Test Instruments

Refer to section 4.1.2 to get information of above instrument.

4.7.4 Test Procedure

- Set resolution bandwidth (RBW) = 100kHz
- Set the video bandwidth (VBW) $\geq 3 \times$ RBW, Detector = Peak.
- Trace mode = max hold.
- Sweep = auto couple.
- Measure the maximum width of the emission that is constrained by the frequencies associated with the two amplitude points (upper and lower) that are attenuated by 6 dB relative to the maximum level measured in the fundamental emission

4.7.5 Deviation from Test Standard

No deviation.

4.7.6 EUT Operating Condition

The software provided by client to enable the EUT under transmission condition continuously at lowest, middle and highest channel frequencies individually.

4.7.7 Test Results

802.11a

Channel	Frequency (MHz)	6dB Bandwidth (MHz)				Minimum Limit (MHz)	Pass / Fail
		Chain 0	Chain 1	Chain 2	Chain 3		
149	5745	16.40	16.36	15.21	16.38	0.5	Pass
157	5785	16.38	16.38	15.21	16.38	0.5	Pass
165	5825	16.12	16.38	15.39	16.33	0.5	Pass

802.11n (HT20)

Channel	Frequency (MHz)	6dB Bandwidth (MHz)				Minimum Limit (MHz)	Pass / Fail
		Chain 0	Chain 1	Chain 2	Chain 3		
149	5745	17.62	16.61	15.21	17.56	0.5	Pass
157	5785	17.59	17.33	15.18	16.60	0.5	Pass
165	5825	17.23	17.26	15.22	16.33	0.5	Pass

802.11n (HT40)

Channel	Frequency (MHz)	6dB Bandwidth (MHz)				Minimum Limit (MHz)	Pass / Fail
		Chain 0	Chain 1	Chain 2	Chain 3		
151	5755	35.24	35.22	35.25	35.14	0.5	Pass
159	5795	35.28	35.21	35.16	35.25	0.5	Pass

802.11ac (VHT80)

Channel	Frequency (MHz)	6dB Bandwidth (MHz)				Minimum Limit (MHz)	Pass / Fail
		Chain 0	Chain 1	Chain 2	Chain 3		
155	5775	75.67	75.98	75.52	75.51	0.5	Pass

Spectrum Plot of Worst Value

802.11a

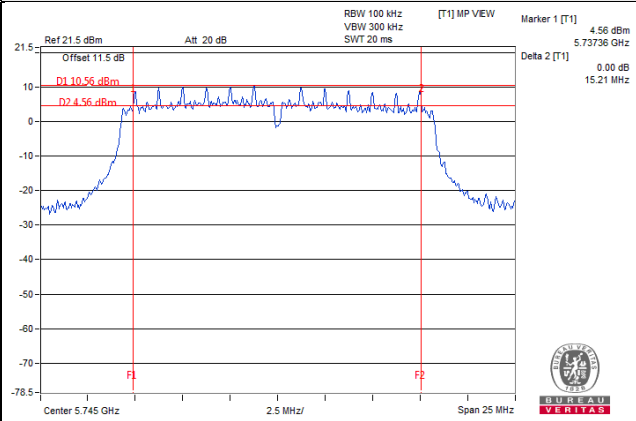

802.11n (HT20)

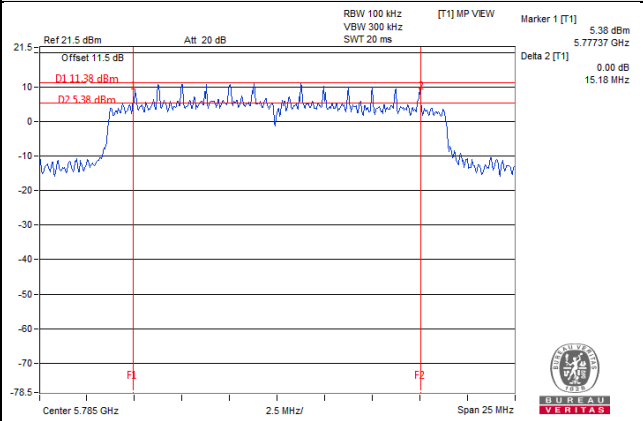

802.11n (HT40)

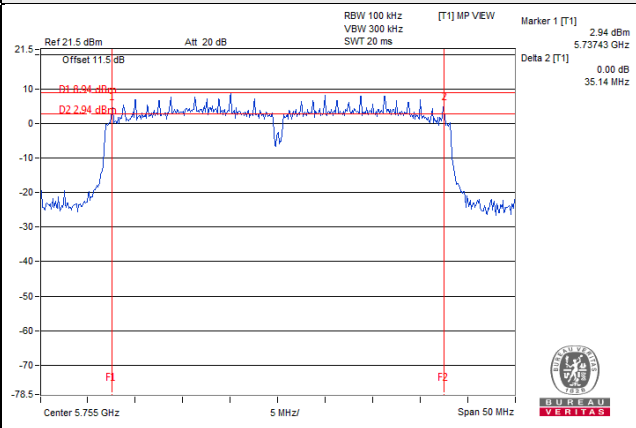

802.11ac (VHT80)

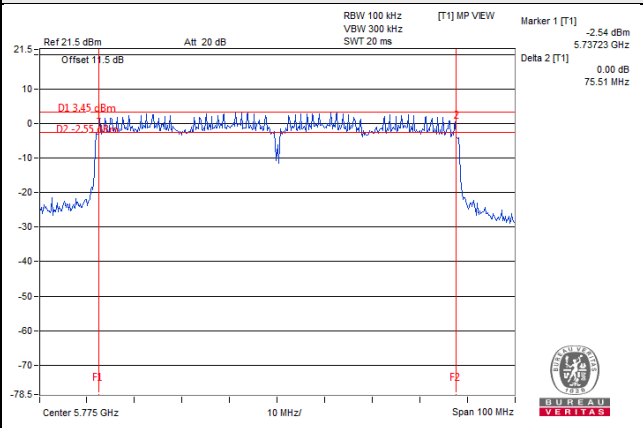

5 Pictures of Test Arrangements

Please refer to the attached file (Test Setup Photo).

Annex A- Radiated Out of Band Emission (OOBE) Measurement (For U-NII-3 band)

802.11a

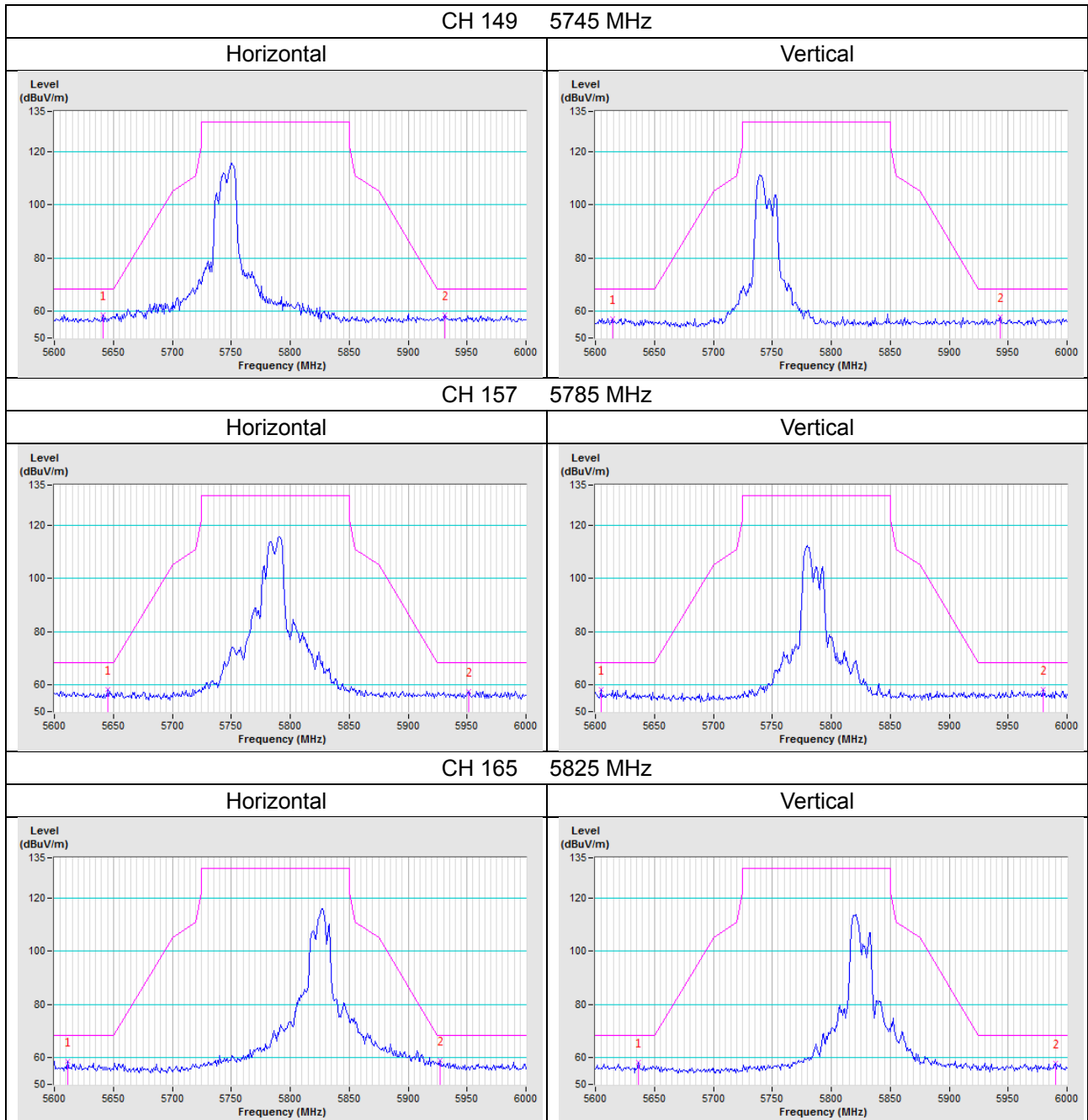

802.11n (HT20)

CH 149 5745 MHz

Horizontal

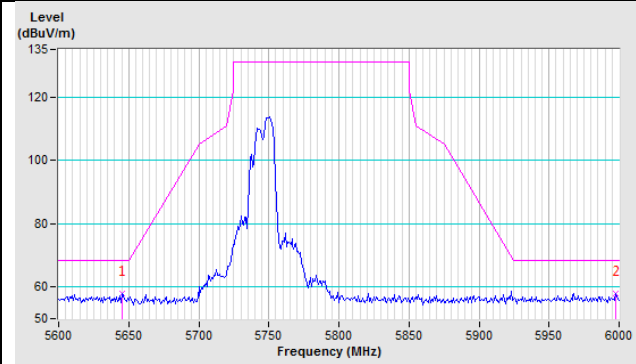

Vertical

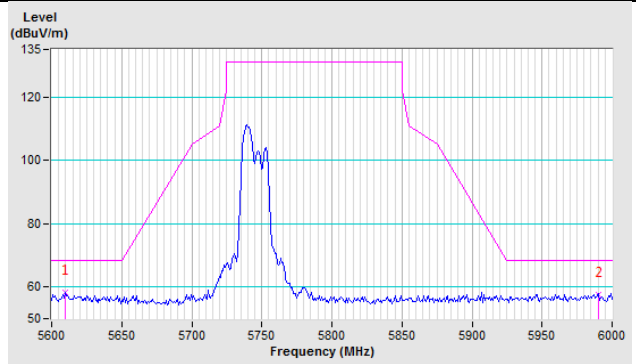

CH 157 5785 MHz

Horizontal

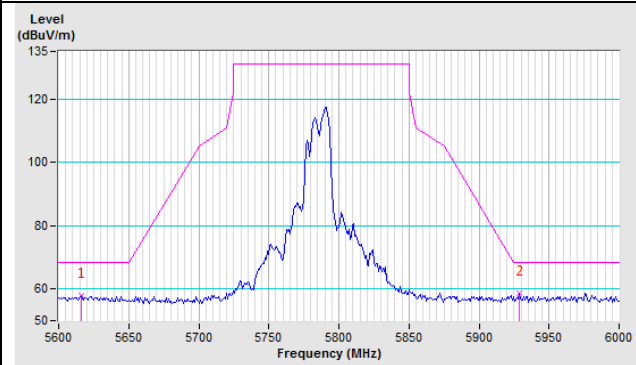

Vertical

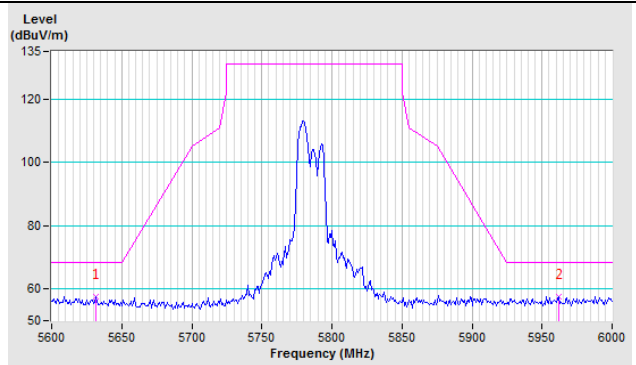

CH 165 5825 MHz

Horizontal

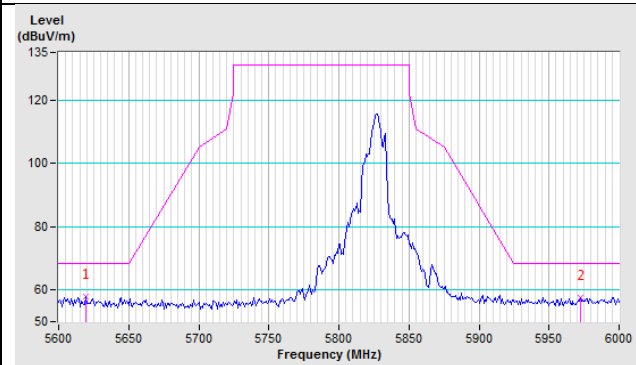

Vertical

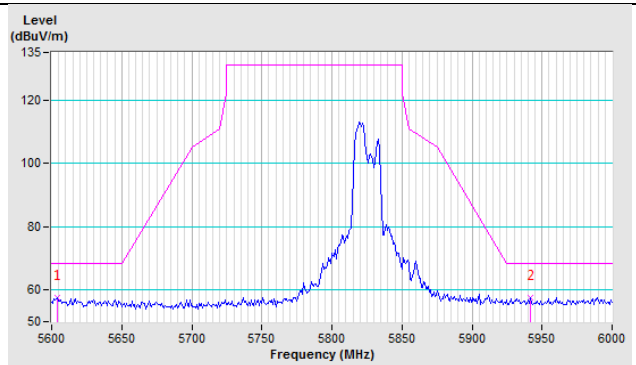

802.11n (HT40)

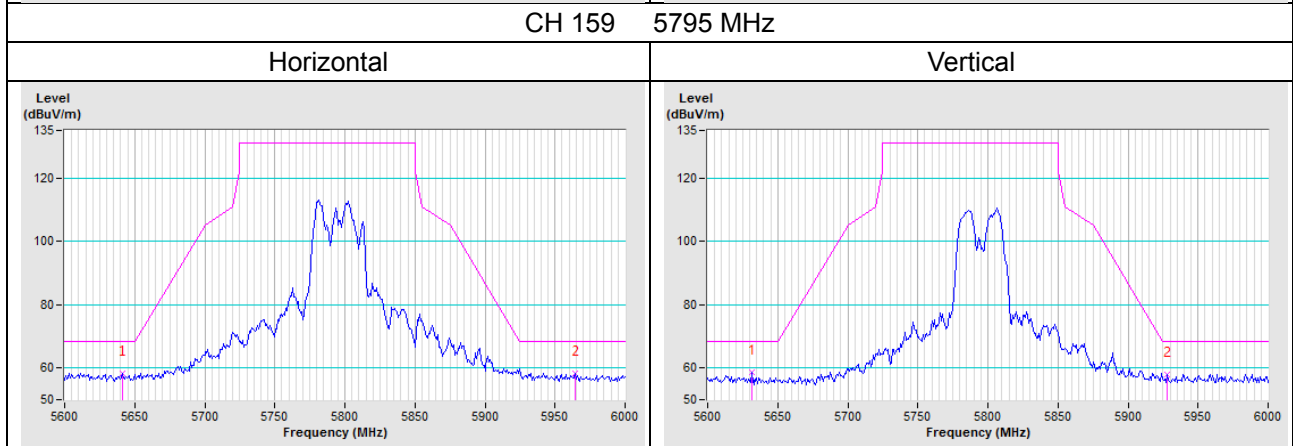
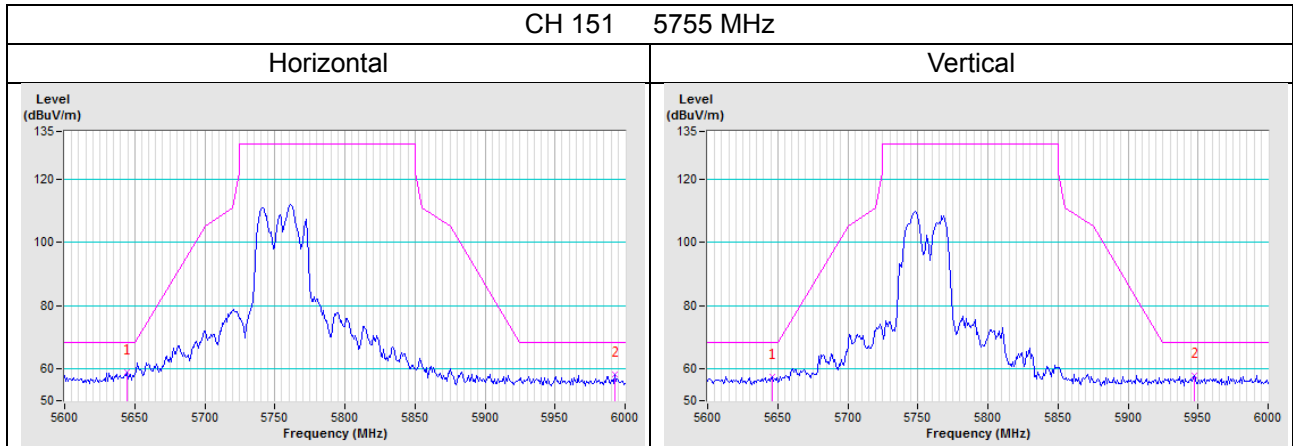

802.11ac (VHT80)

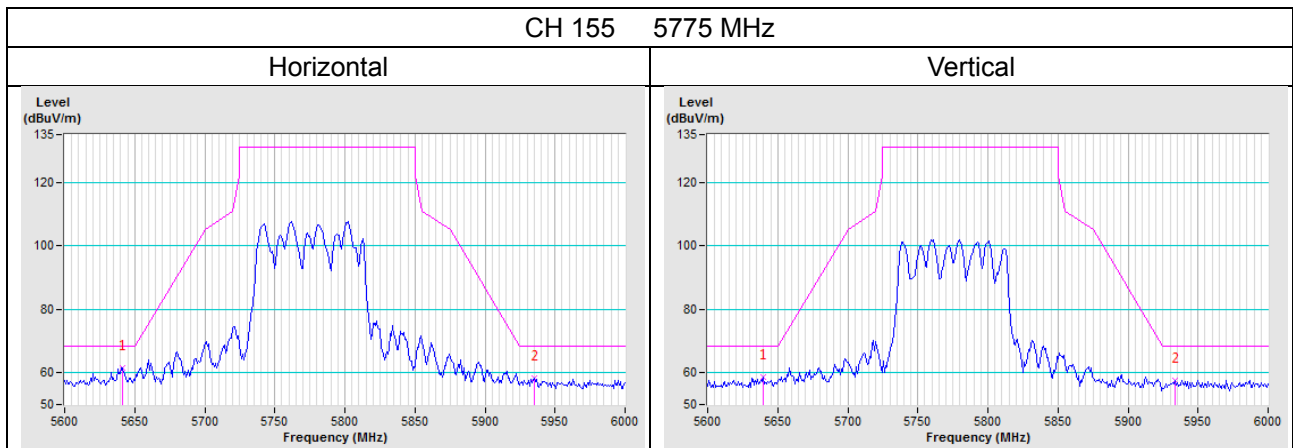

Appendix – Information of the Testing Laboratories

We, Bureau Veritas Consumer Products Services (H.K.) Ltd., Taoyuan Branch, were founded in 1988 to provide our best service in EMC, Radio, Telecom and Safety consultation. Our laboratories are FCC recognized accredited test firms and accredited and approved according to ISO/IEC 17025.

If you have any comments, please feel free to contact us at the following:

Lin Kou EMC/RF Lab

Tel: 886-2-26052180

Fax: 886-2-26051924

Hsin Chu EMC/RF/Telecom Lab

Tel: 886-3-6668565

Fax: 886-3-6668323

Hwa Ya EMC/RF/Safety

Tel: 886-3-3183232

Fax: 886-3-3270892

Email: service.adt@tw.bureauveritas.com

Web Site: www.bureauveritas-adt.com

The address and road map of all our labs can be found in our web site also.

--- END ---