

FCC Test Report

Report No.: RF181115C24B

FCC ID: 2ARXKVHE09

Test Model: VHE09

Series Model: VHE09XXX (X=A-Z, 0-9, blank or "-")

Received Date: Mar. 30, 2019

Test Date: Mar. 30 ~ Apr. 23, 2019

Issued Date: Aug. 26, 2019

Applicant: Veea Inc

Address: 164 E 83rd Street, New York NY, 10028, USA

Issued By: Bureau Veritas Consumer Products Services (H.K.) Ltd., Taoyuan Branch

Lab Address: No. 47-2, 14th Ling, Chia Pau Vil., Lin Kou Dist., New Taipei City, Taiwan (R.O.C.)

Test Location: No. 19, Hwa Ya 2nd Rd., Wen Hwa Vil., Kwei Shan Dist., Taoyuan City 33383, TAIWAN (R.O.C.)

**FCC Registration /
Designation Number:** 788550 / TW0003



This report is for your exclusive use. Any copying or replication of this report to or for any other person or entity, or use of our name or trademark, is permitted only with our prior written permission. This report sets forth our findings solely with respect to the test samples identified herein. The results set forth in this report are not indicative or representative of the quality or characteristics of the lot from which a test sample was taken or any similar or identical product unless specifically and expressly noted. Our report includes all of the tests requested by you and the results thereof based upon the information that you provided to us. You have 60 days from date of issuance of this report to notify us of any material error or omission caused by our negligence, provided, however, that such notice shall be in writing and shall specifically address the issue you wish to raise. A failure to raise such issue within the prescribed time shall constitute your unqualified acceptance of the completeness of this report, the tests conducted and the correctness of the report contents. Unless specific mention, the uncertainty of measurement has been explicitly taken into account to declare the compliance or non-compliance to the specification. This report should not be used by the client to claim product certification, approval, or endorsement by TAF or any government agencies.

Table of Contents

Release Control Record	4
1 Certificate of Conformity	5
2 Summary of Test Results	6
2.1 Measurement Uncertainty.....	6
2.2 Modification Record.....	6
3 General Information	7
3.1 General Description of EUT.....	7
3.2 Description of Test Modes.....	9
3.2.1 Test Mode Applicability and Tested Channel Detail.....	10
3.3 Duty Cycle of Test Signal.....	12
3.4 Description of Support Units.....	13
3.4.1 Configuration of System under Test.....	13
3.5 General Description of Applied Standards.....	14
4 Test Types and Results	15
4.1 Radiated Emission and Bandedge Measurement.....	15
4.1.1 Limits of Radiated Emission and Bandedge Measurement.....	15
4.1.2 Test Instruments.....	16
4.1.3 Test Procedures.....	17
4.1.4 Deviation from Test Standard.....	18
4.1.5 Test Setup.....	18
4.1.6 EUT Operating Conditions.....	19
4.1.7 Test Results.....	20
4.2 Conducted Emission Measurement.....	48
4.2.1 Limits of Conducted Emission Measurement.....	48
4.2.2 Test Instruments.....	48
4.2.3 Test Procedures.....	49
4.2.4 Deviation from Test Standard.....	49
4.2.5 Test Setup.....	49
4.2.6 EUT Operating Conditions.....	49
4.2.7 Test Results.....	50
4.3 Transmit Power Measurement.....	54
4.3.1 Limits of Transmit Power Measurement.....	54
4.3.2 Test Setup.....	54
4.3.3 Test Instruments.....	55
4.3.4 Test Procedure.....	55
4.3.5 Deviation from Test Standard.....	55
4.3.6 EUT Operating Conditions.....	55
4.3.7 Test Result.....	56
4.4 Occupied Bandwidth Measurement.....	72
4.4.1 Test Setup.....	72
4.4.2 Test Instruments.....	72
4.4.3 Test Procedure.....	72
4.4.4 Test Result.....	73
4.5 Peak Power Spectral Density Measurement.....	76
4.5.1 Limits of Peak Power Spectral Density Measurement.....	76
4.5.2 Test Setup.....	76
4.5.3 Test Instruments.....	76
4.5.4 Test Procedures.....	77
4.5.5 Deviation from Test Standard.....	77
4.5.6 EUT Operating Conditions.....	77
4.5.7 Test Results.....	78
4.6 Frequency Stability.....	84
4.6.1 Limits of Frequency Stability Measurement.....	84

4.6.2	Test Setup.....	84
4.6.3	Test Instruments	84
4.6.4	Test Procedure	84
4.6.5	Deviation from Test Standard	85
4.6.6	EUT Operating Condition	85
4.6.7	Test Results	85
4.7	6dB Bandwidth Measurement.....	86
4.7.1	Limits of 6dB Bandwidth Measurement.....	86
4.7.2	Test Setup.....	86
4.7.3	Test Instruments	86
4.7.4	Test Procedure	86
4.7.5	Deviation from Test Standard	86
4.7.6	EUT Operating Condition	86
4.7.7	Test Results	87
5	Pictures of Test Arrangements.....	89
	Appendix – Information of the Testing Laboratories	90

Release Control Record

Issue No.	Description	Date Issued
RF181115C24B	Original release.	Aug. 26, 2019

1 Certificate of Conformity

Product: veeaHub

Brand: 

Test Model: VHE09

Series Model: VHE09XXX (X=A-Z, 0-9, blank or "-")

Sample Status: Engineering sample

Applicant: Veea Inc

Test Date: Mar. 30 ~ Apr. 23, 2019

Standards: 47 CFR FCC Part 15, Subpart E (Section 15.407)
ANSI C63.10:2013

The above equipment has been tested by **Bureau Veritas Consumer Products Services (H.K.) Ltd., Taoyuan Branch**, and found compliance with the requirement of the above standards. The test record, data evaluation & Equipment Under Test (EUT) configurations represented herein are true and accurate accounts of the measurements of the sample's RF characteristics under the conditions specified in this report.

Prepared by : _____

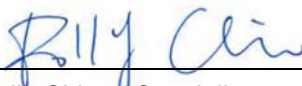
Polly Chien / Specialist

Date: _____ Aug. 26, 2019

Approved by : _____

Bruce Chen / Senior Project Engineer

Date: _____ Aug. 26, 2019

2 Summary of Test Results

47 CFR FCC Part 15, Subpart E (Section 15.407)			
FCC Clause	Test Item	Result	Remarks
15.407(b)(6)	AC Power Conducted Emissions	Pass	Meet the requirement of limit. Minimum passing margin is -1.08dB at 0.49017MHz.
15.407(b)(1/2/3/4(i/ii)/6)	Radiated Emissions & Band Edge Measurement	Pass	Meet the requirement of limit. Minimum passing margin is -1.3dB at 5470.00MHz.
15.407(a)(1/2/3)	Max Average Transmit Power	Pass	Meet the requirement of limit.
---	Occupied Bandwidth Measurement	Pass	Meet the requirement of limit.
15.407(a)(1/2/3)	Peak Power Spectral Density	Pass	Meet the requirement of limit. (U-NII-3 Band only)
15.407(e)	6dB bandwidth	Pass	Meet the requirement of limit.
15.407(g)	Frequency Stability	Pass	Meet the requirement of limit.
15.203	Antenna Requirement	Pass	No antenna connector is used.

Note: Determining compliance based on the results of the compliance measurement, not taking into account measurement instrumentation uncertainty.

2.1 Measurement Uncertainty

Where relevant, the following measurement uncertainty levels have been estimated for tests performed on the EUT as specified in CISPR 16-4-2:

Measurement	Frequency	Expanded Uncertainty (k=2) (±)
Conducted Emissions at mains ports	150kHz ~ 30MHz	2.94 dB
Radiated Emissions up to 1 GHz	9kHz ~ 30MHz	3.04 dB
	30MHz ~ 200MHz	3.63 dB
	200MHz ~ 1000MHz	3.64 dB
Radiated Emissions above 1 GHz	1GHz ~ 18GHz	2.29 dB
	18GHz ~ 40GHz	2.29 dB

2.2 Modification Record

There were no modifications required for compliance.

3 General Information

3.1 General Description of EUT

Product	veeaHub
Brand	
Test Model	VHE09
Series Model	VHE09XXX (X=A-Z, 0-9, blank or "-")
Sample Status	Engineering sample
Power Supply Rating	48Vdc (Adapter and PoE)
Modulation Type	256QAM, 64QAM, 16QAM, QPSK, BPSK
Modulation Technology	OFDM
Transfer Rate	802.11a: 54/48/36/24/18/12/9/6Mbps 802.11n: up to 600Mbps 802.11ac: up to 3466.7Mbps
Operating Frequency	5260~5320MHz, 5500~5720MHz
Number of Channel	5260~5320MHz: 802.11a, 802.11n (HT20), 802.11ac (VHT20): 4 802.11n (HT40), 802.11ac (VHT40): 2 802.11ac (VHT80): 1 5500~5720MHz: 802.11a, 802.11n (HT20), 802.11ac (VHT20): 12 802.11n (HT40), 802.11ac (VHT40): 6 802.11ac (VHT80): 3
Output Power	CDD mode: 5260~5320MHz: 235.941mW 5500~5720MHz: 242.304mW Beamforming mode: 5260~5320MHz: 58.993mW 5500~5720MHz: 60.584mW
Antenna Type	Chip antenna with 2.1dBi gain
Antenna Connector	NA
Accessory Device	Adapter
Cable Supplied	NA

Note:

1. This report is prepared for FCC class II permissive change. This report is issued as a supplementary report to the original report no. RF181115C24-1. The difference is adding 5260~5320MHz, 5500~5720MHz band by software. Therefore, all tests had been tested.
2. The EUT incorporates a MIMO function. Physically, the EUT provides 4 completed transmitters and 4 receivers.

Modulation Mode	TX Function	Beamforming
802.11a	4TX	Not support
802.11n (HT20)	4TX	Support
802.11n (HT40)	4TX	Support
802.11ac (VHT20)	4TX	Support
802.11ac (VHT40)	4TX	Support
802.11ac (VHT80)	4TX	Support

* The modulation and bandwidth are similar for HT20/HT40 on 802.11n mode and VHT20/VHT40 on 802.11ac mode, therefore investigated worst case to representative mode in test report. (Final test mode refer section 3.2.1)

* CDD mode and Beamforming mode are presented in output power test item. For other test items, CDD mode is the worst case for final tests.

3. The EUT uses following adapter and PoE.

Adapter	
Brand	EDAC Power Electronics Co., Ltd.
Model	EA1062SGR-480
Input Power	100-240Vac ~2.5A, 50-60Hz
Output Power	48Vdc / 1.35A
Power Line	1.2m DC cable with one core

PoE (Support unit)	
Model	APOE02-WM
Output Power	48Vdc

4. WLAN, Zigbee and Bluetooth technology can transmit at same time.
5. Spurious emission of the simultaneous operation (WLAN 2.4GHz + WLAN 5GHz) has been evaluated and no non-compliance was found.

3.2 Description of Test Modes

5260~5320MHz:

4 channels are provided for 802.11a, 802.11n (HT20), 802.11ac (VHT20):

Channel	Frequency	Channel	Frequency
52	5260 MHz	60	5300 MHz
56	5280 MHz	64	5320 MHz

2 channels are provided for 802.11n (HT40), 802.11ac (VHT40):

Channel	Frequency	Channel	Frequency
54	5270 MHz	62	5310 MHz

1 channel is provided for 802.11ac (VHT80):

Channel	Frequency
58	5290 MHz

5500~5720MHz:

12 channels are provided for 802.11a, 802.11n (HT20), 802.11ac (VHT20):

Channel	Frequency	Channel	Frequency
100	5500 MHz	124	5620 MHz
104	5520 MHz	128	5640 MHz
108	5540 MHz	132	5660 MHz
112	5560 MHz	136	5680 MHz
116	5580 MHz	140	5700 MHz
120	5600 MHz	144	5720 MHz

6 channels are provided for 802.11n (HT40), 802.11ac (VHT40):

Channel	Frequency	Channel	Frequency
102	5510 MHz	126	5630 MHz
110	5550 MHz	134	5670 MHz
118	5590 MHz	142	5710 MHz

3 channels are provided for 802.11ac (VHT80):

Channel	Frequency	Channel	Frequency
106	5530 MHz	138	5690 MHz
122	5610 MHz		

3.2.1 Test Mode Applicability and Tested Channel Detail

EUT Configure Mode	Applicable to				Description
	RE \geq 1G	RE<1G	PLC	APCM	
A	√	√	√	√	Power from adapter
B	-	√	√	-	Power from PoE

Where RE \geq 1G: Radiated Emission above 1GHz & Bandedge Measurement
 RE<1G: Radiated Emission below 1GHz
 PLC: Power Line Conducted Emission
 APCM: Antenna Port Conducted Measurement

Note:

- The EUT had been pre-tested on the positioned of each 3 axis. The worst case was found when positioned on Y-plane.
- "-": Means no effect.
- Radiated emission (below 1GHz) and power line conducted emission test items chosen the worst maximum power.

Radiated Emission Test (Above 1GHz):

- Pre-Scan has been conducted to determine the worst-case mode from all possible combinations between available modulations, data rates and antenna ports (if EUT with antenna diversity architecture).
- Following channel(s) was (were) selected for the final test as listed below.

EUT Configure Mode	Mode	Frequency Band (MHz)	Available Channel	Tested Channel	Modulation Technology	Data Rate (Mbps)	Remark
A	802.11a	5260-5320	52 to 64	52, 60, 64	OFDM	6.0	-
A	802.11n (HT20)		52 to 64	52, 60, 64	OFDM	6.5	-
A	802.11n (HT40)		54 to 62	54, 62	OFDM	13.5	-
A	802.11ac (VHT80)		58	58	OFDM	29.3	-
A	802.11a	5500-5720	100 to 144	100, 116, 140, 144	OFDM	6.0	-
A	802.11n (HT20)		100 to 144	100, 116, 140, 144	OFDM	6.5	-
A	802.11n (HT40)		102 to 142	102, 110, 134, 142	OFDM	13.5	-
A	802.11ac (VHT80)		106 to 138	106, 122, 138	OFDM	29.3	-

Radiated Emission Test (Below 1GHz):

- Pre-Scan has been conducted to determine the worst-case mode from all possible combinations between available modulations, data rates and antenna ports (if EUT with antenna diversity architecture).
- Following channel(s) was (were) selected for the final test as listed below.

EUT Configure Mode	Mode	Frequency Band (MHz)	Available Channel	Tested Channel	Modulation Technology	Data Rate (Mbps)	Remark
A, B	802.11ac (VHT80)	5500-5720	52 to 64	106	OFDM	29.3	-

Power Line Conducted Emission Test:

- Pre-Scan has been conducted to determine the worst-case mode from all possible combinations between available modulations, data rates and antenna ports (if EUT with antenna diversity architecture).
- Following channel(s) was (were) selected for the final test as listed below.

EUT Configure Mode	Mode	Frequency Band (MHz)	Available Channel	Tested Channel	Modulation Technology	Data Rate (Mbps)	Remark
A, B	802.11ac (VHT80)	5500-5720	52 to 64	106	OFDM	29.3	-

Antenna Port Conducted Measurement:

- This item includes all test value of each mode, but only includes spectrum plot of worst value of each mode.
- Pre-Scan has been conducted to determine the worst-case mode from all possible combinations between available modulations, data rates and antenna ports (if EUT with antenna diversity architecture).
- Following channel(s) was (were) selected for the final test as listed below.

EUT Configure Mode	Mode	Frequency Band (MHz)	Available Channel	Tested Channel	Modulation Technology	Data Rate (Mbps)	Remark
A	802.11a	5260-5320	52 to 64	52, 60, 64	OFDM	6.0	-
A	802.11n (HT20)		52 to 64	52, 60, 64	OFDM	6.5	-
A	802.11n (HT40)		54 to 62	54, 62	OFDM	13.5	-
A	802.11ac (VHT80)		58	58	OFDM	29.3	-
A	802.11a	5500-5720	100 to 144	100, 116, 140, 144	OFDM	6.0	-
A	802.11n (HT20)		100 to 144	100, 116, 140, 144	OFDM	6.5	-
A	802.11n (HT40)		102 to 142	102, 110, 134, 142	OFDM	13.5	-
A	802.11ac (VHT80)		106 to 138	106, 122, 138	OFDM	29.3	-

Test Condition:

Applicable to	Environmental Conditions	Input Power	Tested by
RE \geq 1G	24 deg. C, 69% RH	120Vac, 60Hz	Willy Cheng
RE<1G	24 deg. C, 69% RH	120Vac, 60Hz 48Vdc	Adair Peng
PLC	25 deg. C, 75% RH	120Vac, 60Hz 48Vdc	Adair Peng
APCM	25 deg. C, 60% RH	120Vac, 60Hz	Alan Wu

3.3 Duty Cycle of Test Signal

Duty cycle of test signal is $\geq 98\%$, duty factor is not required.
 Duty cycle of test signal is $< 98\%$, duty factor shall be considered.

802.11a: Duty cycle = $2.048/2.135 = 0.959$, Duty factor = $10 * \log(1/0.959) = 0.18$

802.11n (HT20): Duty cycle = $4.98/5.07 = 0.982$

802.11n (HT40): Duty cycle = $2.423/2.503 = 0.968$, Duty factor = $10 * \log(1/0.968) = 0.14$

802.11ac (VHT80): Duty cycle = $1.143/1.22 = 0.937$, Duty factor = $10 * \log(1/0.937) = 0.28$



3.4 Description of Support Units

The EUT has been tested as an independent unit together with other necessary accessories or support units. The following support units or accessories were used to form a representative test configuration during the tests.

ID	Product	Brand	Model No.	Serial No.	FCC ID	Remarks
A.	Notebook	DELL	E5410	1HC2XM1	FCC DoC Approved	-
B.	Load	NA	NA	NA	NA	-
C.	USB Flash	HP	v250W	04	NA	-
D.	USB Flash	HP	v250W	05	NA	-
E.	USB Flash	HP	v250W	06	NA	-
F.	PoE	NA	APOE02-WM	NA	NA	Provided by manufacturer

Note:

1. All power cords of the above support units are non-shielded (1.8m).
2. Item A acted as a communication partner to transfer data.

ID	Descriptions	Qty.	Length (m)	Shielding (Yes/No)	Cores (Qty.)	Remarks
1.	RJ45 cable	1	1.5	N	0	Cat5e
2.	RJ45 cable	1	6	N	0	Cat5e
3.	Console cable	1	2	N	0	-
4.	RJ45 cable	1	1.5	N	0	Cat5e

3.4.1 Configuration of System under Test

Test Mode A

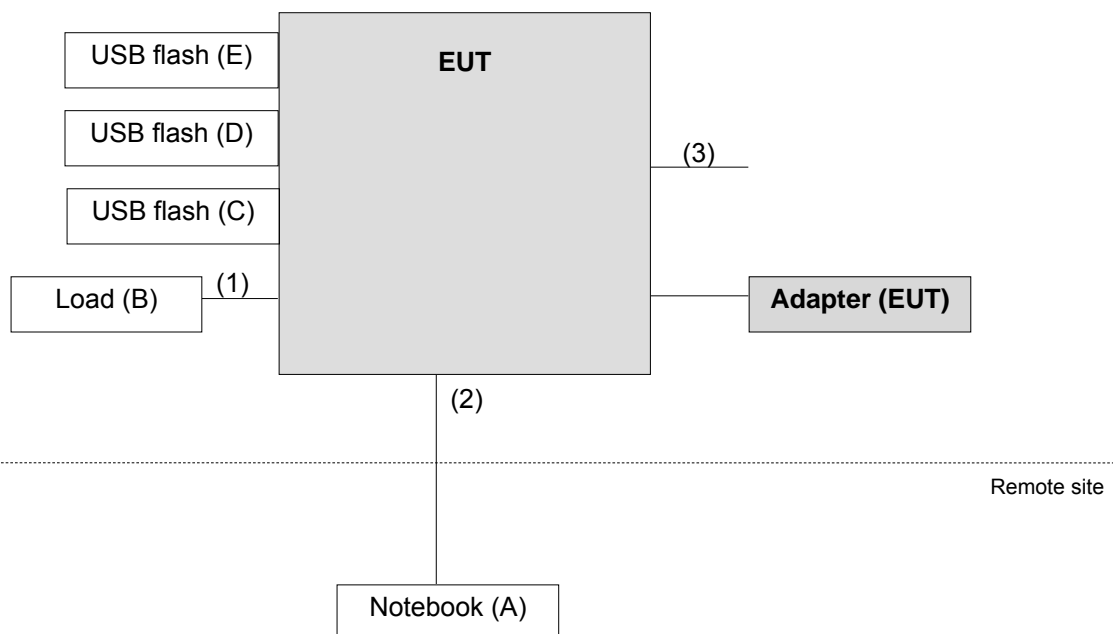

Test Mode B

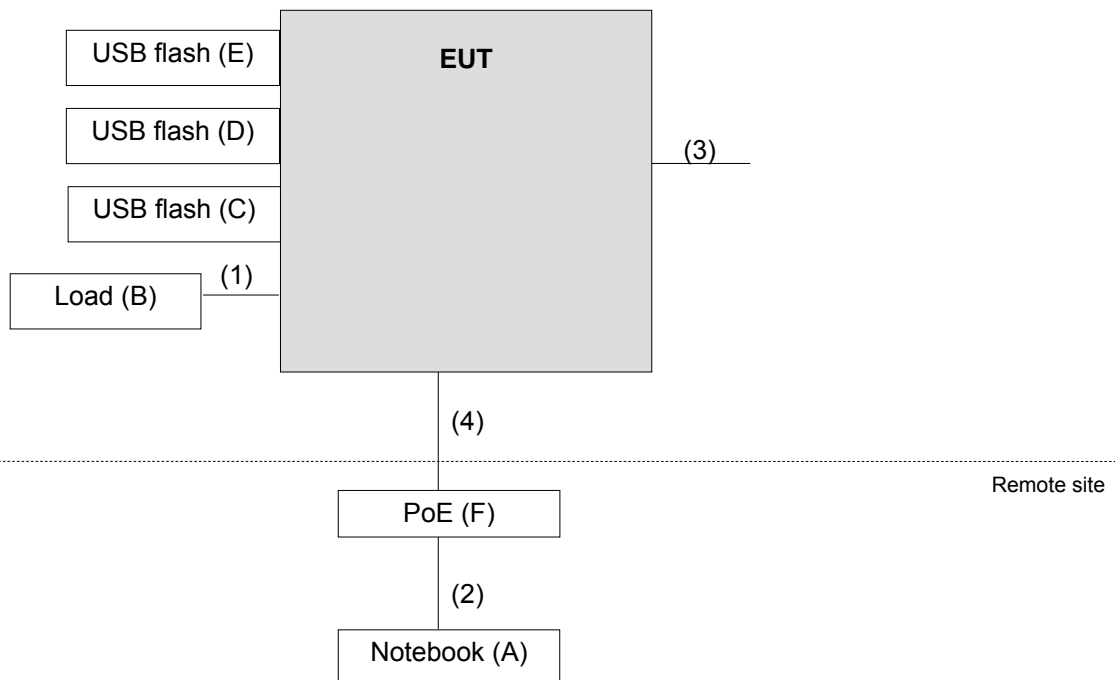

3.5 General Description of Applied Standards

The EUT is a RF Product. According to the specifications of the manufacturer, it must comply with the requirements of the following standards:

FCC Part 15, Subpart E (15.407)

KDB 789033 D02 General UNII Test Procedure New Rules v02r01

KDB 662911 D01 Multiple Transmitter Output v02r01

ANSI C63.10:2013

All test items have been performed and recorded as per the above standards.

4 Test Types and Results

4.1 Radiated Emission and Bandedge Measurement

4.1.1 Limits of Radiated Emission and Bandedge Measurement

Radiated emissions which fall in the restricted bands must comply with the radiated emission limits specified as below table.

Frequencies (MHz)	Field Strength (microvolts/meter)	Measurement Distance (meters)
0.009 ~ 0.490	2400/F(kHz)	300
0.490 ~ 1.705	24000/F(kHz)	30
1.705 ~ 30.0	30	30
30 ~ 88	100	3
88 ~ 216	150	3
216 ~ 960	200	3
Above 960	500	3

NOTE:

1. The lower limit shall apply at the transition frequencies.
2. Emission level (dBuV/m) = 20 log Emission level (uV/m).
3. For frequencies above 1000MHz, the field strength limits are based on average detector, however, the peak field strength of any emission shall not exceed the maximum permitted average limits, specified above by more than 20dB under any condition of modulation.

Limits of unwanted emission out of the restricted bands

Applicable To		Limit	
789033 D02 General UNII Test Procedure New Rules v02r01		Field Strength at 3m	
		PK: 74 (dBµV/m)	AV: 54 (dBµV/m)
Frequency Band	Applicable To	EIRP Limit	Equivalent Field Strength at 3m
5150~5250 MHz	15.407(b)(1)	PK: -27 (dBm/MHz)	PK: 68.2(dBµV/m)
5250~5350 MHz	15.407(b)(2)		
5470~5725 MHz	15.407(b)(3)		
5725~5850 MHz	<input checked="" type="checkbox"/> 15.407(b)(4)(i)	PK: -27 (dBm/MHz) ^{*1} PK: 10 (dBm/MHz) ^{*2} PK: 15.6 (dBm/MHz) ^{*3} PK: 27 (dBm/MHz) ^{*4}	PK: 68.2(dBµV/m) ^{*1} PK: 105.2 (dBµV/m) ^{*2} PK: 110.8(dBµV/m) ^{*3} PK: 122.2 (dBµV/m) ^{*4}
	<input type="checkbox"/> 15.407(b)(4)(ii)	Emission limits in section 15.247(d)	
^{*1} beyond 75 MHz or more above of the band edge. ^{*3} below the band edge increasing linearly to a level of 15.6 dBm/MHz at 5 MHz above.		^{*2} below the band edge increasing linearly to 10 dBm/MHz at 25 MHz above. ^{*4} from 5 MHz above or below the band edge increasing linearly to a level of 27 dBm/MHz at the band edge.	

Note: The following formula is used to convert the equipment isotropic radiated power (eirp) to field strength:

$$E = \frac{1000000 \sqrt{30P}}{3} \mu\text{V/m, where P is the eirp (Watts).}$$

4.1.2 Test Instruments

Tested date: Mar. 30 ~ Apr. 23, 2019

Description & Manufacturer	Model No.	Serial No.	Cal. Date	Cal. Due
Test Receiver ROHDE & SCHWARZ	ESIB7	100187	May 29, 2018	May 28, 2019
Spectrum Analyzer ROHDE & SCHWARZ	FSP40	100040	Sep. 25, 2018	Sep. 24, 2019
BILOG Antenna SCHWARZBECK	VULB9168	9168-171	Nov. 22, 2018	Nov. 21, 2019
HORN Antenna SCHWARZBECK	9120D	209	Nov. 25, 2018	Nov. 24, 2019
HORN Antenna SCHWARZBECK	BBHA 9170	BBHA9170241	Nov. 25, 2018	Nov. 24, 2019
Loop Antenna TESEQ	HLA 6121	45745	Jun. 14, 2018	Jun. 13, 2019
Preamplifier Agilent (Below 1GHz)	8447D	2944A10738	Aug. 21, 2018	Aug. 20, 2019
Preamplifier Agilent (Above 1GHz)	8449B	3008A02465	Mar. 27, 2019	Mar. 26, 2020
RF signal cable HUBER+SUHNER	SUCOFLEX 104	Cable-CH3-03 (223653/4)	Aug. 21, 2018	Aug. 20, 2019
RF signal cable HUBER+SUHNER& EMCI	SUCOFLEX 104&EMC104-SM-SM-8 000	Cable-CH3-03 (309224+170907)	Aug. 21, 2018	Aug. 20, 2019
Software BV ADT	ADT_Radiated_ V7.6.15.9.5	NA	NA	NA
Antenna Tower inn-co GmbH	MA 4000	013303	NA	NA
Antenna Tower Controller BV ADT	AT100	AT93021702	NA	NA
Turn Table BV ADT	TT100	TT93021702	NA	NA
Turn Table Controller BV ADT	SC100	SC93021702	NA	NA
Boresight Antenna Fixture	FBA-01	FBA-SIP01	NA	NA
USB Wideband Power Sensor KEYSIGHT	U2021XA	MY55050005/MY5519 0004/MY55190007/MY 55210005	Jul. 17, 2018	Jul. 16, 2019
Pre-amplifier (18GHz-40GHz) EMC	EMC184045B	980175	Nov. 14, 2018	Nov. 13, 2019

Note: 1. The calibration interval of the above test instruments is 12 months and the calibrations are traceable to NML/ROC and NIST/USA.
 2. The test was performed in HwaYa Chamber 3.

4.1.3 Test Procedures

For Radiated emission below 30MHz

- a. The EUT was placed on the top of a rotating table 0.8 meters above the ground at a 3 meter chamber room. The table was rotated 360 degrees to determine the position of the highest radiation.
- b. The EUT was set 3 meters away from the interference-receiving antenna, which was mounted on the top of a variable-height antenna tower.
- c. Parallel, perpendicular, and ground-parallel orientations of the antenna are set to make the measurement.
- d. For each suspected emission, the EUT was arranged to its worst case and the rotatable table was turned from 0 degrees to 360 degrees to find the maximum reading.
- e. The test-receiver system was set to Quasi-Peak Detect Function and Specified Bandwidth with Maximum Hold Mode.

Note:

1. The resolution bandwidth and video bandwidth of test receiver/spectrum analyzer is 9kHz at frequency below 30MHz.

For Radiated emission above 30MHz

- a. The EUT was placed on the top of a rotating table 0.8 meters (for 30MHz ~ 1GHz) / 1.5 meters (for above 1GHz) above the ground at 3 meter chamber room for test. The table was rotated 360 degrees to determine the position of the highest radiation.
- b. The EUT was set 3 meters away from the interference-receiving antenna, which was mounted on the top of a variable-height antenna tower.
- c. The height of antenna is varied from one meter to four meters above the ground to determine the maximum value of the field strength. Both horizontal and vertical polarizations of the antenna are set to make the measurement.
- d. For each suspected emission, the EUT was arranged to its worst case and then the antenna was tuned to heights from 1 meter to 4 meters and the rotatable table was turned from 0 degrees to 360 degrees to find the maximum reading.
- e. The test-receiver system was set to quasi-peak detect function and specified bandwidth with maximum hold mode when the test frequency is below 1 GHz.
- f. The test-receiver system was set to peak and average detect function and specified bandwidth with maximum hold mode when the test frequency is above 1 GHz. If the peak reading value also meets average limit, measurement with the average detector is unnecessary.

Note:

1. The resolution bandwidth and video bandwidth of test receiver/spectrum analyzer is 120kHz for Quasi-peak detection (QP) at frequency below 1GHz.
2. The resolution bandwidth of test receiver/spectrum analyzer is 1 MHz and the video bandwidth is 3 MHz for Peak detection (PK) at frequency above 1GHz.
3. The resolution bandwidth of test receiver/spectrum analyzer is 1MHz and the video bandwidth is $\geq 1/T$ (Duty cycle < 98%) or 10Hz (Duty cycle $\geq 98\%$) for Average detection (AV) at frequency above 1GHz.
4. All modes of operation were investigated and the worst-case emissions are reported.

4.1.4 Deviation from Test Standard

No deviation.

4.1.5 Test Setup

For Radiated emission below 30MHz

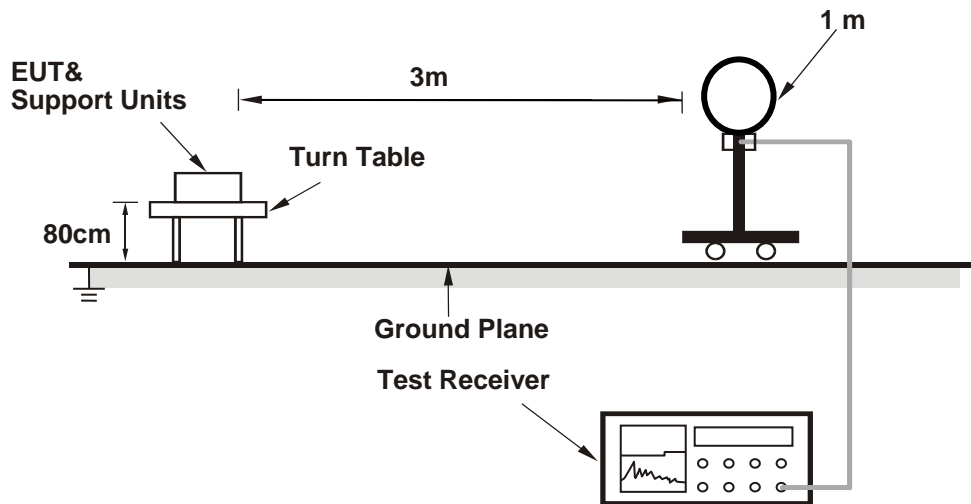

For Radiated emission 30MHz to 1GHz

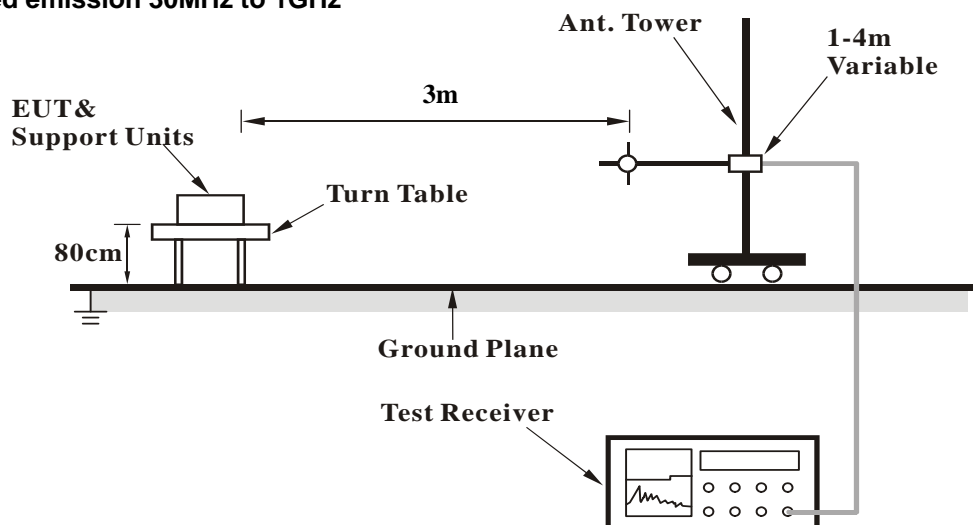

For Radiated emission above 1GHz

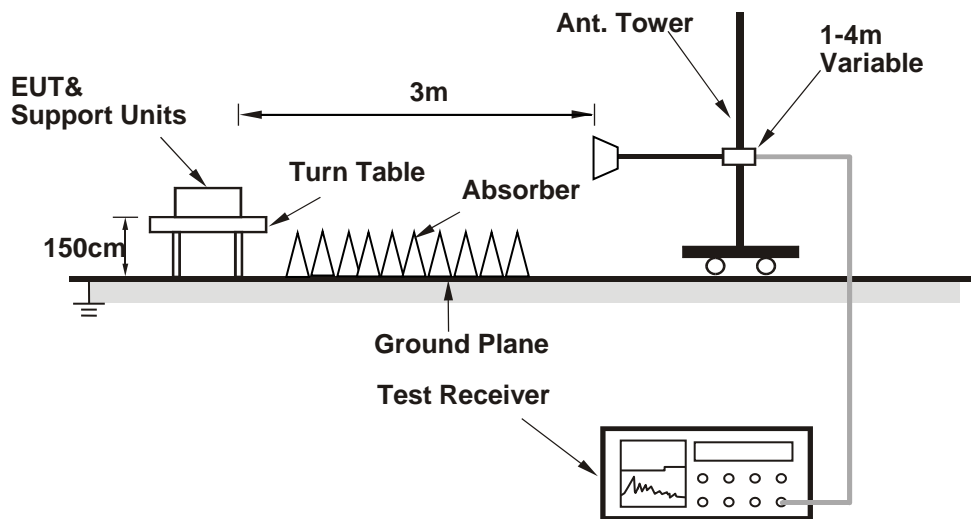

For the actual test configuration, please refer to the attached file (Test Setup Photo).

4.1.6 EUT Operating Conditions

- Placed the EUT on the testing table.
- Prepared a notebook to act as a communication partner and placed it outside of testing area.
- The communication partner connected with EUT via a RJ45 cable and ran a test program (QRCT V3.0.264.0) to enable EUT under transmission condition continuously at specific channel frequency.
- The necessary accessories enable the system in full functions.

4.1.7 Test Results

Above 1GHz data:

802.11a

CHANNEL	TX Channel 52	DETECTOR FUNCTION	Peak (PK)
FREQUENCY RANGE	1GHz ~ 40GHz		Average (AV)

ANTENNA POLARITY & TEST DISTANCE: HORIZONTAL AT 3 M

NO.	FREQ. (MHz)	EMISSION LEVEL (dBuV/m)	LIMIT (dBuV/m)	MARGIN (dB)	ANTENNA HEIGHT (m)	TABLE ANGLE (Degree)	RAW VALUE (dBuV)	CORRECTION FACTOR (dB/m)
1	5150.00	56.4 PK	74.0	-17.6	1.82 H	351	52.0	4.4
2	5150.00	44.0 AV	54.0	-10.0	1.82 H	351	39.6	4.4
3	*5260.00	118.0 PK			1.71 H	5	78.7	39.3
4	*5260.00	107.1 AV			1.71 H	5	67.8	39.3
5	#10520.00	59.9 PK	68.2	-8.3	2.26 H	132	42.6	17.3

ANTENNA POLARITY & TEST DISTANCE: VERTICAL AT 3 M

NO.	FREQ. (MHz)	EMISSION LEVEL (dBuV/m)	LIMIT (dBuV/m)	MARGIN (dB)	ANTENNA HEIGHT (m)	TABLE ANGLE (Degree)	RAW VALUE (dBuV)	CORRECTION FACTOR (dB/m)
1	5150.00	57.2 PK	74.0	-16.8	1.66 V	38	52.8	4.4
2	5150.00	44.0 AV	54.0	-10.0	1.66 V	38	39.6	4.4
3	*5260.00	117.7 PK			1.59 V	20	78.4	39.3
4	*5260.00	106.2 AV			1.59 V	20	66.9	39.3
5	#10520.00	59.9 PK	68.2	-8.3	1.69 V	147	42.6	17.3

Remarks:

1. Emission Level(dBuV/m) = Raw Value(dBuV) + Correction Factor(dB/m)
2. Correction Factor(dB/m) = Antenna Factor(dB/m) + Cable Factor(dB) – Pre-Amplifier Factor(dB)
3. The other emission levels were very low against the limit.
4. Margin value = Emission Level – Limit value
5. " * ": Fundamental frequency.
6. " # ": The radiated frequency is out of the restricted band.

CHANNEL	TX Channel 60	DETECTOR FUNCTION	Peak (PK)
FREQUENCY RANGE	1GHz ~ 40GHz		Average (AV)

ANTENNA POLARITY & TEST DISTANCE: HORIZONTAL AT 3 M

NO.	FREQ. (MHz)	EMISSION LEVEL (dBuV/m)	LIMIT (dBuV/m)	MARGIN (dB)	ANTENNA HEIGHT (m)	TABLE ANGLE (Degree)	RAW VALUE (dBuV)	CORRECTION FACTOR (dB/m)
1	*5300.00	117.3 PK			1.54 H	286	78.0	39.3
2	*5300.00	106.4 AV			1.54 H	286	67.1	39.3
3	10600.00	60.9 PK	74.0	-13.1	2.63 H	182	43.1	17.8
4	10600.00	46.5 AV	54.0	-7.5	2.63 H	182	28.7	17.8

ANTENNA POLARITY & TEST DISTANCE: VERTICAL AT 3 M

NO.	FREQ. (MHz)	EMISSION LEVEL (dBuV/m)	LIMIT (dBuV/m)	MARGIN (dB)	ANTENNA HEIGHT (m)	TABLE ANGLE (Degree)	RAW VALUE (dBuV)	CORRECTION FACTOR (dB/m)
1	*5300.00	117.5 PK			1.61 V	19	78.2	39.3
2	*5300.00	106.3 AV			1.61 V	19	67.0	39.3
3	10600.00	60.1 PK	74.0	-13.9	1.79 V	183	42.3	17.8
4	10600.00	46.8 AV	54.0	-7.2	1.79 V	183	29.0	17.8

Remarks:

1. Emission Level(dBuV/m) = Raw Value(dBuV) + Correction Factor(dB/m)
2. Correction Factor(dB/m) = Antenna Factor(dB/m) + Cable Factor(dB) – Pre-Amplifier Factor(dB)
3. The other emission levels were very low against the limit.
4. Margin value = Emission Level – Limit value
5. " * ": Fundamental frequency.
6. " # ": The radiated frequency is out of the restricted band.

CHANNEL	TX Channel 64	DETECTOR FUNCTION	Peak (PK)
FREQUENCY RANGE	1GHz ~ 40GHz		Average (AV)

ANTENNA POLARITY & TEST DISTANCE: HORIZONTAL AT 3 M

NO.	FREQ. (MHz)	EMISSION LEVEL (dBuV/m)	LIMIT (dBuV/m)	MARGIN (dB)	ANTENNA HEIGHT (m)	TABLE ANGLE (Degree)	RAW VALUE (dBuV)	CORRECTION FACTOR (dB/m)
1	*5320.00	117.7 PK			1.02 H	305	78.4	39.3
2	*5320.00	106.0 AV			1.02 H	305	66.7	39.3
3	5350.00	60.9 PK	74.0	-13.1	1.04 H	305	56.6	4.3
4	5350.00	46.9 AV	54.0	-7.1	1.04 H	305	42.6	4.3
5	10640.00	59.4 PK	74.0	-14.6	2.18 H	254	41.8	17.6
6	10640.00	46.1 AV	54.0	-7.9	2.18 H	254	28.5	17.6

ANTENNA POLARITY & TEST DISTANCE: VERTICAL AT 3 M

NO.	FREQ. (MHz)	EMISSION LEVEL (dBuV/m)	LIMIT (dBuV/m)	MARGIN (dB)	ANTENNA HEIGHT (m)	TABLE ANGLE (Degree)	RAW VALUE (dBuV)	CORRECTION FACTOR (dB/m)
1	*5320.00	116.9 PK			1.55 V	17	77.6	39.3
2	*5320.00	105.6 AV			1.55 V	17	66.3	39.3
3	5350.00	61.0 PK	74.0	-13.0	1.67 V	15	56.7	4.3
4	5350.00	48.5 AV	54.0	-5.5	1.67 V	15	44.2	4.3
5	10640.00	59.2 PK	74.0	-14.8	1.38 V	226	41.6	17.6
6	10640.00	45.9 AV	54.0	-8.1	1.38 V	226	28.3	17.6

Remarks:

1. Emission Level(dBuV/m) = Raw Value(dBuV) + Correction Factor(dB/m)
2. Correction Factor(dB/m) = Antenna Factor(dB/m) + Cable Factor(dB) – Pre-Amplifier Factor(dB)
3. The other emission levels were very low against the limit.
4. Margin value = Emission Level – Limit value
5. " * ": Fundamental frequency.
6. " # ": The radiated frequency is out of the restricted band.

CHANNEL	TX Channel 100	DETECTOR FUNCTION	Peak (PK)
FREQUENCY RANGE	1GHz ~ 40GHz		Average (AV)

ANTENNA POLARITY & TEST DISTANCE: HORIZONTAL AT 3 M

NO.	FREQ. (MHz)	EMISSION LEVEL (dBuV/m)	LIMIT (dBuV/m)	MARGIN (dB)	ANTENNA HEIGHT (m)	TABLE ANGLE (Degree)	RAW VALUE (dBuV)	CORRECTION FACTOR (dB/m)
1	5460.00	58.0 PK	74.0	-16.0	1.56 H	113	53.4	4.6
2	5460.00	46.8 AV	54.0	-7.2	1.56 H	113	42.2	4.6
3	#5470.00	60.6 PK	68.2	-7.6	1.44 H	58	56.0	4.6
4	*5500.00	115.2 PK			1.46 H	51	75.4	39.8
5	*5500.00	104.4 AV			1.46 H	51	64.6	39.8
6	11000.00	60.2 PK	74.0	-13.8	2.86 H	251	41.5	18.7
7	11000.00	47.0 AV	54.0	-7.0	2.86 H	251	28.3	18.7

ANTENNA POLARITY & TEST DISTANCE: VERTICAL AT 3 M

NO.	FREQ. (MHz)	EMISSION LEVEL (dBuV/m)	LIMIT (dBuV/m)	MARGIN (dB)	ANTENNA HEIGHT (m)	TABLE ANGLE (Degree)	RAW VALUE (dBuV)	CORRECTION FACTOR (dB/m)
1	5460.00	61.4 PK	74.0	-12.6	3.05 V	324	56.8	4.6
2	5460.00	48.5 AV	54.0	-5.5	3.05 V	324	43.9	4.6
3	#5470.00	61.3 PK	68.2	-6.9	2.39 V	342	56.7	4.6
4	*5500.00	117.9 PK			2.96 V	327	78.1	39.8
5	*5500.00	107.3 AV			2.96 V	327	67.5	39.8
6	11000.00	60.4 PK	74.0	-13.6	2.41 V	148	41.7	18.7
7	11000.00	46.9 AV	54.0	-7.1	2.41 V	148	28.2	18.7

Remarks:

1. Emission Level(dBuV/m) = Raw Value(dBuV) + Correction Factor(dB/m)
2. Correction Factor(dB/m) = Antenna Factor(dB/m) + Cable Factor(dB) – Pre-Amplifier Factor(dB)
3. The other emission levels were very low against the limit.
4. Margin value = Emission Level – Limit value
5. " * ": Fundamental frequency.
6. " # ": The radiated frequency is out of the restricted band.

CHANNEL	TX Channel 116	DETECTOR FUNCTION	Peak (PK)
FREQUENCY RANGE	1GHz ~ 40GHz		Average (AV)

ANTENNA POLARITY & TEST DISTANCE: HORIZONTAL AT 3 M

NO.	FREQ. (MHz)	EMISSION LEVEL (dBuV/m)	LIMIT (dBuV/m)	MARGIN (dB)	ANTENNA HEIGHT (m)	TABLE ANGLE (Degree)	RAW VALUE (dBuV)	CORRECTION FACTOR (dB/m)
1	*5580.00	117.7 PK			1.43 H	34	77.9	39.8
2	*5580.00	106.5 AV			1.43 H	34	66.7	39.8
3	11160.00	62.5 PK	74.0	-11.5	2.60 H	1	44.7	17.8
4	11160.00	49.5 AV	54.0	-4.5	2.60 H	1	31.7	17.8

ANTENNA POLARITY & TEST DISTANCE: VERTICAL AT 3 M

NO.	FREQ. (MHz)	EMISSION LEVEL (dBuV/m)	LIMIT (dBuV/m)	MARGIN (dB)	ANTENNA HEIGHT (m)	TABLE ANGLE (Degree)	RAW VALUE (dBuV)	CORRECTION FACTOR (dB/m)
1	*5580.00	117.8 PK			1.45 V	359	78.0	39.8
2	*5580.00	106.9 AV			1.45 V	359	67.1	39.8
3	11160.00	64.2 PK	74.0	-9.8	1.48 V	354	46.4	17.8
4	11160.00	50.3 AV	54.0	-3.7	1.48 V	354	32.5	17.8

Remarks:

1. Emission Level(dBuV/m) = Raw Value(dBuV) + Correction Factor(dB/m)
2. Correction Factor(dB/m) = Antenna Factor(dB/m) + Cable Factor(dB) – Pre-Amplifier Factor(dB)
3. The other emission levels were very low against the limit.
4. Margin value = Emission Level – Limit value
5. " * ": Fundamental frequency.
6. " # ": The radiated frequency is out of the restricted band.

CHANNEL	TX Channel 140	DETECTOR FUNCTION	Peak (PK)
FREQUENCY RANGE	1GHz ~ 40GHz		Average (AV)

ANTENNA POLARITY & TEST DISTANCE: HORIZONTAL AT 3 M

NO.	FREQ. (MHz)	EMISSION LEVEL (dBuV/m)	LIMIT (dBuV/m)	MARGIN (dB)	ANTENNA HEIGHT (m)	TABLE ANGLE (Degree)	RAW VALUE (dBuV)	CORRECTION FACTOR (dB/m)
1	*5700.00	116.4 PK			1.36 H	8	76.6	39.8
2	*5700.00	106.1 AV			1.36 H	8	66.3	39.8
3	#5725.00	60.4 PK	68.2	-7.8	1.20 H	10	55.7	4.7
4	11400.00	59.3 PK	74.0	-14.7	1.40 H	310	41.6	17.7
5	11400.00	46.3 AV	54.0	-7.7	1.40 H	310	28.6	17.7

ANTENNA POLARITY & TEST DISTANCE: VERTICAL AT 3 M

NO.	FREQ. (MHz)	EMISSION LEVEL (dBuV/m)	LIMIT (dBuV/m)	MARGIN (dB)	ANTENNA HEIGHT (m)	TABLE ANGLE (Degree)	RAW VALUE (dBuV)	CORRECTION FACTOR (dB/m)
1	*5700.00	115.7 PK			2.58 V	353	75.9	39.8
2	*5700.00	104.7 AV			2.58 V	353	64.9	39.8
3	#5725.00	59.0 PK	68.2	-9.2	2.24 V	358	54.3	4.7
4	11400.00	59.0 PK	74.0	-15.0	2.32 V	255	41.3	17.7
5	11400.00	46.1 AV	54.0	-7.9	2.32 V	255	28.4	17.7

Remarks:

1. Emission Level(dBuV/m) = Raw Value(dBuV) + Correction Factor(dB/m)
2. Correction Factor(dB/m) = Antenna Factor(dB/m) + Cable Factor(dB) – Pre-Amplifier Factor(dB)
3. The other emission levels were very low against the limit.
4. Margin value = Emission Level – Limit value
5. " * ": Fundamental frequency.
6. " # ": The radiated frequency is out of the restricted band.

CHANNEL	TX Channel 144	DETECTOR FUNCTION	Peak (PK)
FREQUENCY RANGE	1GHz ~ 40GHz		Average (AV)

ANTENNA POLARITY & TEST DISTANCE: HORIZONTAL AT 3 M

NO.	FREQ. (MHz)	EMISSION LEVEL (dBuV/m)	LIMIT (dBuV/m)	MARGIN (dB)	ANTENNA HEIGHT (m)	TABLE ANGLE (Degree)	RAW VALUE (dBuV)	CORRECTION FACTOR (dB/m)
1	*5720.00	117.9 PK			2.31 H	49	77.9	40.0
2	*5720.00	106.7 AV			2.31 H	49	66.7	40.0
3	#5850.00	58.3 PK	68.2	-9.9	2.66 H	53	53.0	5.3
4	11440.00	60.3 PK	74.0	-13.7	2.29 H	249	42.5	17.8
5	11440.00	47.0 AV	54.0	-7.0	2.29 H	249	29.2	17.8

ANTENNA POLARITY & TEST DISTANCE: VERTICAL AT 3 M

NO.	FREQ. (MHz)	EMISSION LEVEL (dBuV/m)	LIMIT (dBuV/m)	MARGIN (dB)	ANTENNA HEIGHT (m)	TABLE ANGLE (Degree)	RAW VALUE (dBuV)	CORRECTION FACTOR (dB/m)
1	*5720.00	117.6 PK			1.24 V	313	77.6	40.0
2	*5720.00	106.7 AV			1.24 V	313	66.7	40.0
3	#5850.00	58.9 PK	68.2	-9.3	1.33 V	323	53.6	5.3
4	11440.00	60.1 PK	74.0	-13.9	2.30 V	156	42.3	17.8
5	11440.00	47.1 AV	54.0	-6.9	2.30 V	156	29.3	17.8

Remarks:

1. Emission Level(dBuV/m) = Raw Value(dBuV) + Correction Factor(dB/m)
2. Correction Factor(dB/m) = Antenna Factor(dB/m) + Cable Factor(dB) – Pre-Amplifier Factor(dB)
3. The other emission levels were very low against the limit.
4. Margin value = Emission Level – Limit value
5. " * ": Fundamental frequency.
6. " # ": The radiated frequency is out of the restricted band.

802.11n (HT20)

CHANNEL	TX Channel 52	DETECTOR FUNCTION	Peak (PK) Average (AV)
FREQUENCY RANGE	1GHz ~ 40GHz		

ANTENNA POLARITY & TEST DISTANCE: HORIZONTAL AT 3 M

NO.	FREQ. (MHz)	EMISSION LEVEL (dBuV/m)	LIMIT (dBuV/m)	MARGIN (dB)	ANTENNA HEIGHT (m)	TABLE ANGLE (Degree)	RAW VALUE (dBuV)	CORRECTION FACTOR (dB/m)
1	5150.00	56.6 PK	74.0	-17.4	1.51 H	279	52.2	4.4
2	5150.00	44.3 AV	54.0	-9.7	1.51 H	279	39.9	4.4
3	*5260.00	118.2 PK			1.58 H	291	78.9	39.3
4	*5260.00	106.5 AV			1.58 H	291	67.2	39.3
5	#10520.00	59.6 PK	74.0	-14.4	1.96 H	168	42.3	17.3

ANTENNA POLARITY & TEST DISTANCE: VERTICAL AT 3 M

NO.	FREQ. (MHz)	EMISSION LEVEL (dBuV/m)	LIMIT (dBuV/m)	MARGIN (dB)	ANTENNA HEIGHT (m)	TABLE ANGLE (Degree)	RAW VALUE (dBuV)	CORRECTION FACTOR (dB/m)
1	5150.00	57.6 PK	74.0	-16.4	1.82 V	11	53.2	4.4
2	5150.00	44.3 AV	54.0	-9.7	1.82 V	11	39.9	4.4
3	*5260.00	117.0 PK			1.57 V	19	77.7	39.3
4	*5260.00	105.6 AV			1.57 V	19	66.3	39.3
5	#10520.00	59.8 PK	68.2	-8.4	1.72 V	199	42.5	17.3

Remarks:

1. Emission Level(dBuV/m) = Raw Value(dBuV) + Correction Factor(dB/m)
2. Correction Factor(dB/m) = Antenna Factor(dB/m) + Cable Factor(dB) – Pre-Amplifier Factor(dB)
3. The other emission levels were very low against the limit.
4. Margin value = Emission Level – Limit value
5. " * ": Fundamental frequency.
6. " # ": The radiated frequency is out of the restricted band.

CHANNEL	TX Channel 60	DETECTOR FUNCTION	Peak (PK)
FREQUENCY RANGE	1GHz ~ 40GHz		Average (AV)

ANTENNA POLARITY & TEST DISTANCE: HORIZONTAL AT 3 M

NO.	FREQ. (MHz)	EMISSION LEVEL (dBuV/m)	LIMIT (dBuV/m)	MARGIN (dB)	ANTENNA HEIGHT (m)	TABLE ANGLE (Degree)	RAW VALUE (dBuV)	CORRECTION FACTOR (dB/m)
1	*5300.00	117.9 PK			1.51 H	290	78.6	39.3
2	*5300.00	106.1 AV			1.51 H	290	66.8	39.3
3	10600.00	59.6 PK	74.0	-14.4	2.56 H	188	41.8	17.8
4	10600.00	47.1 AV	54.0	-6.9	2.56 H	188	29.3	17.8

ANTENNA POLARITY & TEST DISTANCE: VERTICAL AT 3 M

NO.	FREQ. (MHz)	EMISSION LEVEL (dBuV/m)	LIMIT (dBuV/m)	MARGIN (dB)	ANTENNA HEIGHT (m)	TABLE ANGLE (Degree)	RAW VALUE (dBuV)	CORRECTION FACTOR (dB/m)
1	*5300.00	117.4 PK			1.61 V	18	78.1	39.3
2	*5300.00	105.7 AV			1.61 V	18	66.4	39.3
3	10600.00	60.2 PK	74.0	-13.8	2.23 V	158	42.4	17.8
4	10600.00	46.4 AV	54.0	-7.6	2.23 V	158	28.6	17.8

Remarks:

1. Emission Level(dBuV/m) = Raw Value(dBuV) + Correction Factor(dB/m)
2. Correction Factor(dB/m) = Antenna Factor(dB/m) + Cable Factor(dB) – Pre-Amplifier Factor(dB)
3. The other emission levels were very low against the limit.
4. Margin value = Emission Level – Limit value
5. " * ": Fundamental frequency.
6. " # ": The radiated frequency is out of the restricted band.

CHANNEL	TX Channel 64	DETECTOR FUNCTION	Peak (PK)
FREQUENCY RANGE	1GHz ~ 40GHz		Average (AV)

ANTENNA POLARITY & TEST DISTANCE: HORIZONTAL AT 3 M

NO.	FREQ. (MHz)	EMISSION LEVEL (dBuV/m)	LIMIT (dBuV/m)	MARGIN (dB)	ANTENNA HEIGHT (m)	TABLE ANGLE (Degree)	RAW VALUE (dBuV)	CORRECTION FACTOR (dB/m)
1	*5320.00	117.7 PK			1.14 H	304	78.4	39.3
2	*5320.00	105.5 AV			1.14 H	304	66.2	39.3
3	5350.00	59.8 PK	74.0	-14.2	1.20 H	298	55.5	4.3
4	5350.00	37.2 AV	54.0	-16.8	1.20 H	298	32.9	4.3
5	10640.00	59.3 PK	74.0	-14.7	2.56 H	249	41.7	17.6
6	10640.00	45.4 AV	54.0	-8.6	2.56 H	249	27.8	17.6

ANTENNA POLARITY & TEST DISTANCE: VERTICAL AT 3 M

NO.	FREQ. (MHz)	EMISSION LEVEL (dBuV/m)	LIMIT (dBuV/m)	MARGIN (dB)	ANTENNA HEIGHT (m)	TABLE ANGLE (Degree)	RAW VALUE (dBuV)	CORRECTION FACTOR (dB/m)
1	*5320.00	116.9 PK			1.58 V	19	77.6	39.3
2	*5320.00	105.1 AV			1.58 V	19	65.8	39.3
3	5350.00	60.8 PK	74.0	-13.2	1.73 V	16	56.5	4.3
4	5350.00	48.9 AV	54.0	-5.1	1.73 V	16	44.6	4.3
5	10640.00	60.2 PK	74.0	-13.8	2.55 V	286	42.6	17.6
6	10640.00	46.5 AV	54.0	-7.5	2.55 V	286	28.9	17.6

Remarks:

1. Emission Level(dBuV/m) = Raw Value(dBuV) + Correction Factor(dB/m)
2. Correction Factor(dB/m) = Antenna Factor(dB/m) + Cable Factor(dB) – Pre-Amplifier Factor(dB)
3. The other emission levels were very low against the limit.
4. Margin value = Emission Level – Limit value
5. " * ": Fundamental frequency.
6. " # ": The radiated frequency is out of the restricted band.

CHANNEL	TX Channel 100	DETECTOR FUNCTION	Peak (PK)
FREQUENCY RANGE	1GHz ~ 40GHz		Average (AV)

ANTENNA POLARITY & TEST DISTANCE: HORIZONTAL AT 3 M

NO.	FREQ. (MHz)	EMISSION LEVEL (dBuV/m)	LIMIT (dBuV/m)	MARGIN (dB)	ANTENNA HEIGHT (m)	TABLE ANGLE (Degree)	RAW VALUE (dBuV)	CORRECTION FACTOR (dB/m)
1	5460.00	59.4 PK	74.0	-14.6	2.63 H	314	54.8	4.6
2	5460.00	47.1 AV	54.0	-6.9	2.63 H	314	42.5	4.6
3	#5470.00	64.4 PK	68.2	-3.8	2.82 H	294	59.8	4.6
4	*5500.00	117.7 PK			2.77 H	294	77.9	39.8
5	*5500.00	107.0 AV			2.77 H	294	67.2	39.8
6	11000.00	61.1 PK	74.0	-12.9	1.64 H	239	42.4	18.7
7	11000.00	46.9 AV	54.0	-7.1	1.64 H	239	28.2	18.7

ANTENNA POLARITY & TEST DISTANCE: VERTICAL AT 3 M

NO.	FREQ. (MHz)	EMISSION LEVEL (dBuV/m)	LIMIT (dBuV/m)	MARGIN (dB)	ANTENNA HEIGHT (m)	TABLE ANGLE (Degree)	RAW VALUE (dBuV)	CORRECTION FACTOR (dB/m)
1	5460.00	61.0 PK	74.0	-13.0	3.14 V	322	56.4	4.6
2	5460.00	48.0 AV	54.0	-6.0	3.14 V	322	43.4	4.6
3	#5470.00	61.4 PK	68.2	-6.8	2.99 V	318	56.8	4.6
4	*5500.00	117.6 PK			2.94 V	326	77.8	39.8
5	*5500.00	106.4 AV			2.94 V	326	66.6	39.8
6	11000.00	61.1 PK	74.0	-12.9	1.86 V	231	42.4	18.7
7	11000.00	47.2 AV	54.0	-6.8	1.86 V	231	28.5	18.7

Remarks:

1. Emission Level(dBuV/m) = Raw Value(dBuV) + Correction Factor(dB/m)
2. Correction Factor(dB/m) = Antenna Factor(dB/m) + Cable Factor(dB) – Pre-Amplifier Factor(dB)
3. The other emission levels were very low against the limit.
4. Margin value = Emission Level – Limit value
5. " * ": Fundamental frequency.
6. " # ": The radiated frequency is out of the restricted band.

CHANNEL	TX Channel 116	DETECTOR FUNCTION	Peak (PK)
FREQUENCY RANGE	1GHz ~ 40GHz		Average (AV)

ANTENNA POLARITY & TEST DISTANCE: HORIZONTAL AT 3 M

NO.	FREQ. (MHz)	EMISSION LEVEL (dBuV/m)	LIMIT (dBuV/m)	MARGIN (dB)	ANTENNA HEIGHT (m)	TABLE ANGLE (Degree)	RAW VALUE (dBuV)	CORRECTION FACTOR (dB/m)
1	*5580.00	118.3 PK			1.98 H	304	78.5	39.8
2	*5580.00	106.7 AV			1.98 H	304	66.9	39.8
3	11160.00	63.1 PK	74.0	-10.9	1.72 H	327	45.3	17.8
4	11160.00	49.2 AV	54.0	-4.8	1.72 H	327	31.4	17.8

ANTENNA POLARITY & TEST DISTANCE: VERTICAL AT 3 M

NO.	FREQ. (MHz)	EMISSION LEVEL (dBuV/m)	LIMIT (dBuV/m)	MARGIN (dB)	ANTENNA HEIGHT (m)	TABLE ANGLE (Degree)	RAW VALUE (dBuV)	CORRECTION FACTOR (dB/m)
1	*5580.00	117.7 PK			1.45 V	358	77.9	39.8
2	*5580.00	106.3 AV			1.45 V	358	66.5	39.8
3	11160.00	63.1 PK	74.0	-10.9	1.50 V	356	45.3	17.8
4	11160.00	49.9 AV	54.0	-4.1	1.50 V	356	32.1	17.8

Remarks:

1. Emission Level(dBuV/m) = Raw Value(dBuV) + Correction Factor(dB/m)
2. Correction Factor(dB/m) = Antenna Factor(dB/m) + Cable Factor(dB) – Pre-Amplifier Factor(dB)
3. The other emission levels were very low against the limit.
4. Margin value = Emission Level – Limit value
5. " * ": Fundamental frequency.
6. " # ": The radiated frequency is out of the restricted band.

CHANNEL	TX Channel 140	DETECTOR FUNCTION	Peak (PK)
FREQUENCY RANGE	1GHz ~ 40GHz		Average (AV)

ANTENNA POLARITY & TEST DISTANCE: HORIZONTAL AT 3 M

NO.	FREQ. (MHz)	EMISSION LEVEL (dBuV/m)	LIMIT (dBuV/m)	MARGIN (dB)	ANTENNA HEIGHT (m)	TABLE ANGLE (Degree)	RAW VALUE (dBuV)	CORRECTION FACTOR (dB/m)
1	*5700.00	116.3 PK			3.05 H	8	76.5	39.8
2	*5700.00	105.9 AV			3.05 H	8	66.1	39.8
3	#5725.00	58.7 PK	68.2	-9.5	1.19 H	11	54.0	4.7
4	11400.00	58.5 PK	74.0	-15.5	2.56 H	268	40.8	17.7
5	11400.00	44.9 AV	54.0	-9.1	2.56 H	268	27.2	17.7

ANTENNA POLARITY & TEST DISTANCE: VERTICAL AT 3 M

NO.	FREQ. (MHz)	EMISSION LEVEL (dBuV/m)	LIMIT (dBuV/m)	MARGIN (dB)	ANTENNA HEIGHT (m)	TABLE ANGLE (Degree)	RAW VALUE (dBuV)	CORRECTION FACTOR (dB/m)
1	*5700.00	115.5 PK			1.56 V	3	75.7	39.8
2	*5700.00	104.1 AV			1.56 V	3	64.3	39.8
3	#5725.00	58.2 PK	68.2	-10.0	1.63 V	2	53.5	4.7
4	11400.00	59.3 PK	74.0	-14.7	2.38 V	252	41.6	17.7
5	11400.00	45.6 AV	54.0	-8.4	2.38 V	252	27.9	17.7

Remarks:

1. Emission Level(dBuV/m) = Raw Value(dBuV) + Correction Factor(dB/m)
2. Correction Factor(dB/m) = Antenna Factor(dB/m) + Cable Factor(dB) – Pre-Amplifier Factor(dB)
3. The other emission levels were very low against the limit.
4. Margin value = Emission Level – Limit value
5. " * ": Fundamental frequency.
6. " # ": The radiated frequency is out of the restricted band.

CHANNEL	TX Channel 144	DETECTOR FUNCTION	Peak (PK)
FREQUENCY RANGE	1GHz ~ 40GHz		Average (AV)

ANTENNA POLARITY & TEST DISTANCE: HORIZONTAL AT 3 M

NO.	FREQ. (MHz)	EMISSION LEVEL (dBuV/m)	LIMIT (dBuV/m)	MARGIN (dB)	ANTENNA HEIGHT (m)	TABLE ANGLE (Degree)	RAW VALUE (dBuV)	CORRECTION FACTOR (dB/m)
1	*5720.00	117.7 PK			2.28 H	46	77.7	40.0
2	*5720.00	106.5 AV			2.28 H	46	66.5	40.0
3	#5850.00	58.8 PK	68.2	-9.4	2.33 H	53	53.5	5.3
4	11440.00	60.6 PK	74.0	-13.4	2.45 H	263	42.8	17.8
5	11440.00	47.1 AV	54.0	-6.9	2.45 H	263	29.3	17.8

ANTENNA POLARITY & TEST DISTANCE: VERTICAL AT 3 M

NO.	FREQ. (MHz)	EMISSION LEVEL (dBuV/m)	LIMIT (dBuV/m)	MARGIN (dB)	ANTENNA HEIGHT (m)	TABLE ANGLE (Degree)	RAW VALUE (dBuV)	CORRECTION FACTOR (dB/m)
1	*5720.00	117.2 PK			1.22 V	310	77.2	40.0
2	*5720.00	106.1 AV			1.22 V	310	66.1	40.0
3	#5850.00	58.5 PK	68.2	-9.7	1.29 V	299	53.2	5.3
4	11440.00	60.3 PK	74.0	-13.7	2.49 V	163	42.5	17.8
5	11440.00	46.8 AV	54.0	-7.2	2.49 V	163	29.0	17.8

Remarks:

1. Emission Level(dBuV/m) = Raw Value(dBuV) + Correction Factor(dB/m)
2. Correction Factor(dB/m) = Antenna Factor(dB/m) + Cable Factor(dB) – Pre-Amplifier Factor(dB)
3. The other emission levels were very low against the limit.
4. Margin value = Emission Level – Limit value
5. " * ": Fundamental frequency.
6. " # ": The radiated frequency is out of the restricted band.

802.11n (HT40)

CHANNEL	TX Channel 54	DETECTOR FUNCTION	Peak (PK) Average (AV)
FREQUENCY RANGE	1GHz ~ 40GHz		

ANTENNA POLARITY & TEST DISTANCE: HORIZONTAL AT 3 M

NO.	FREQ. (MHz)	EMISSION LEVEL (dBuV/m)	LIMIT (dBuV/m)	MARGIN (dB)	ANTENNA HEIGHT (m)	TABLE ANGLE (Degree)	RAW VALUE (dBuV)	CORRECTION FACTOR (dB/m)
1	5150.00	56.7 PK	74.0	-17.3	1.32 H	311	52.3	4.4
2	5150.00	44.0 AV	54.0	-10.0	1.32 H	311	39.6	4.4
3	*5270.00	114.1 PK			1.45 H	291	74.8	39.3
4	*5270.00	103.9 AV			1.45 H	291	64.6	39.3
5	#10540.00	59.6 PK	68.2	-8.6	1.83 H	235	42.1	17.5

ANTENNA POLARITY & TEST DISTANCE: VERTICAL AT 3 M

NO.	FREQ. (MHz)	EMISSION LEVEL (dBuV/m)	LIMIT (dBuV/m)	MARGIN (dB)	ANTENNA HEIGHT (m)	TABLE ANGLE (Degree)	RAW VALUE (dBuV)	CORRECTION FACTOR (dB/m)
1	5150.00	47.0 PK	74.0	-27.0	1.68 V	2	42.6	4.4
2	5150.00	44.2 AV	54.0	-9.8	1.68 V	2	39.8	4.4
3	*5270.00	114.9 PK			1.59 V	19	75.6	39.3
4	*5270.00	103.6 AV			1.59 V	19	64.3	39.3
5	#10540.00	59.6 PK	68.2	-8.6	2.69 V	211	42.1	17.5

Remarks:

1. Emission Level(dBuV/m) = Raw Value(dBuV) + Correction Factor(dB/m)
2. Correction Factor(dB/m) = Antenna Factor(dB/m) + Cable Factor(dB) – Pre-Amplifier Factor(dB)
3. The other emission levels were very low against the limit.
4. Margin value = Emission Level – Limit value
5. " * ": Fundamental frequency.
6. " # ": The radiated frequency is out of the restricted band.

CHANNEL	TX Channel 62	DETECTOR FUNCTION	Peak (PK)
FREQUENCY RANGE	1GHz ~ 40GHz		Average (AV)

ANTENNA POLARITY & TEST DISTANCE: HORIZONTAL AT 3 M

NO.	FREQ. (MHz)	EMISSION LEVEL (dBuV/m)	LIMIT (dBuV/m)	MARGIN (dB)	ANTENNA HEIGHT (m)	TABLE ANGLE (Degree)	RAW VALUE (dBuV)	CORRECTION FACTOR (dB/m)
1	*5310.00	114.1 PK			1.51 H	288	74.8	39.3
2	*5310.00	103.3 AV			1.51 H	288	64.0	39.3
3	5350.00	63.2 PK	74.0	-10.8	1.42 H	296	58.9	4.3
4	5350.00	49.6 AV	54.0	-4.4	1.42 H	296	45.3	4.3
5	10620.00	59.5 PK	74.0	-14.5	2.51 H	167	41.8	17.7
6	10620.00	46.6 AV	54.0	-7.4	2.51 H	167	28.9	17.7

ANTENNA POLARITY & TEST DISTANCE: VERTICAL AT 3 M

NO.	FREQ. (MHz)	EMISSION LEVEL (dBuV/m)	LIMIT (dBuV/m)	MARGIN (dB)	ANTENNA HEIGHT (m)	TABLE ANGLE (Degree)	RAW VALUE (dBuV)	CORRECTION FACTOR (dB/m)
1	*5310.00	114.8 PK			1.20 V	355	75.5	39.3
2	*5310.00	104.3 AV			1.20 V	355	65.0	39.3
3	5350.00	62.7 PK	74.0	-11.3	1.26 V	353	58.4	4.3
4	5350.00	49.6 AV	54.0	-4.4	1.26 V	353	45.3	4.3
5	10620.00	60.0 PK	74.0	-14.0	2.53 V	236	42.3	17.7
6	10620.00	46.8 AV	54.0	-7.2	2.53 V	236	29.1	17.7

Remarks:

1. Emission Level(dBuV/m) = Raw Value(dBuV) + Correction Factor(dB/m)
2. Correction Factor(dB/m) = Antenna Factor(dB/m) + Cable Factor(dB) – Pre-Amplifier Factor(dB)
3. The other emission levels were very low against the limit.
4. Margin value = Emission Level – Limit value
5. " * ": Fundamental frequency.
6. " # ": The radiated frequency is out of the restricted band.

CHANNEL	TX Channel 102	DETECTOR FUNCTION	Peak (PK)
FREQUENCY RANGE	1GHz ~ 40GHz		Average (AV)

ANTENNA POLARITY & TEST DISTANCE: HORIZONTAL AT 3 M

NO.	FREQ. (MHz)	EMISSION LEVEL (dBuV/m)	LIMIT (dBuV/m)	MARGIN (dB)	ANTENNA HEIGHT (m)	TABLE ANGLE (Degree)	RAW VALUE (dBuV)	CORRECTION FACTOR (dB/m)
1	5460.00	58.8 PK	74.0	-15.2	1.52 H	313	54.2	4.6
2	5460.00	46.1 AV	54.0	-7.9	1.52 H	313	41.5	4.6
3	#5470.00	63.9 PK	68.2	-4.3	1.75 H	307	59.3	4.6
4	*5510.00	115.0 PK			3.07 H	333	75.1	39.9
5	*5510.00	104.6 AV			3.07 H	333	64.7	39.9
6	11020.00	59.8 PK	74.0	-14.2	1.88 H	203	41.3	18.5
7	11020.00	47.0 AV	54.0	-7.0	1.88 H	203	28.5	18.5

ANTENNA POLARITY & TEST DISTANCE: VERTICAL AT 3 M

NO.	FREQ. (MHz)	EMISSION LEVEL (dBuV/m)	LIMIT (dBuV/m)	MARGIN (dB)	ANTENNA HEIGHT (m)	TABLE ANGLE (Degree)	RAW VALUE (dBuV)	CORRECTION FACTOR (dB/m)
1	5460.00	57.2 PK	74.0	-16.8	2.38 V	341	52.6	4.6
2	5460.00	46.0 AV	54.0	-8.0	2.38 V	341	41.4	4.6
3	#5470.00	63.3 PK	68.2	-4.9	1.63 V	324	58.7	4.6
4	*5510.00	114.6 PK			1.63 V	322	74.7	39.9
5	*5510.00	104.0 AV			1.63 V	322	64.1	39.9
6	11020.00	60.3 PK	74.0	-13.7	2.32 V	262	41.8	18.5
7	11020.00	46.9 AV	54.0	-7.1	2.32 V	262	28.4	18.5

Remarks:

1. Emission Level(dBuV/m) = Raw Value(dBuV) + Correction Factor(dB/m)
2. Correction Factor(dB/m) = Antenna Factor(dB/m) + Cable Factor(dB) – Pre-Amplifier Factor(dB)
3. The other emission levels were very low against the limit.
4. Margin value = Emission Level – Limit value
5. " * ": Fundamental frequency.
6. " # ": The radiated frequency is out of the restricted band.

CHANNEL	TX Channel 110	DETECTOR FUNCTION	Peak (PK)
FREQUENCY RANGE	1GHz ~ 40GHz		Average (AV)

ANTENNA POLARITY & TEST DISTANCE: HORIZONTAL AT 3 M

NO.	FREQ. (MHz)	EMISSION LEVEL (dBuV/m)	LIMIT (dBuV/m)	MARGIN (dB)	ANTENNA HEIGHT (m)	TABLE ANGLE (Degree)	RAW VALUE (dBuV)	CORRECTION FACTOR (dB/m)
1	*5550.00	114.7 PK			2.87 H	294	74.9	39.8
2	*5550.00	104.2 AV			2.87 H	294	64.4	39.8
3	11100.00	59.8 PK	74.0	-14.2	1.76 H	289	41.8	18.0
4	11100.00	47.1 AV	54.0	-6.9	1.76 H	289	29.1	18.0

ANTENNA POLARITY & TEST DISTANCE: VERTICAL AT 3 M

NO.	FREQ. (MHz)	EMISSION LEVEL (dBuV/m)	LIMIT (dBuV/m)	MARGIN (dB)	ANTENNA HEIGHT (m)	TABLE ANGLE (Degree)	RAW VALUE (dBuV)	CORRECTION FACTOR (dB/m)
1	*5550.00	114.8 PK			1.38 V	359	75.0	39.8
2	*5550.00	104.3 AV			1.38 V	359	64.5	39.8
3	11100.00	62.2 PK	74.0	-11.8	1.44 V	356	44.2	18.0
4	11100.00	48.6 AV	54.0	-5.4	1.44 V	356	30.6	18.0

Remarks:

1. Emission Level(dBuV/m) = Raw Value(dBuV) + Correction Factor(dB/m)
2. Correction Factor(dB/m) = Antenna Factor(dB/m) + Cable Factor(dB) – Pre-Amplifier Factor(dB)
3. The other emission levels were very low against the limit.
4. Margin value = Emission Level – Limit value
5. " * ": Fundamental frequency.
6. " # ": The radiated frequency is out of the restricted band.

CHANNEL	TX Channel 134	DETECTOR FUNCTION	Peak (PK)
FREQUENCY RANGE	1GHz ~ 40GHz		Average (AV)

ANTENNA POLARITY & TEST DISTANCE: HORIZONTAL AT 3 M

NO.	FREQ. (MHz)	EMISSION LEVEL (dBuV/m)	LIMIT (dBuV/m)	MARGIN (dB)	ANTENNA HEIGHT (m)	TABLE ANGLE (Degree)	RAW VALUE (dBuV)	CORRECTION FACTOR (dB/m)
1	*5670.00	115.1 PK			3.16 H	6	75.3	39.8
2	*5670.00	104.8 AV			3.16 H	6	65.0	39.8
3	#5725.00	59.8 PK	68.2	-8.4	3.03 H	9	55.1	4.7
4	11340.00	60.0 PK	74.0	-14.0	2.18 H	269	42.2	17.8
5	11340.00	46.4 AV	54.0	-7.6	2.18 H	269	28.6	17.8

ANTENNA POLARITY & TEST DISTANCE: VERTICAL AT 3 M

NO.	FREQ. (MHz)	EMISSION LEVEL (dBuV/m)	LIMIT (dBuV/m)	MARGIN (dB)	ANTENNA HEIGHT (m)	TABLE ANGLE (Degree)	RAW VALUE (dBuV)	CORRECTION FACTOR (dB/m)
1	*5670.00	113.0 PK			1.51 V	359	73.2	39.8
2	*5670.00	102.4 AV			1.51 V	359	62.6	39.8
3	#5725.00	58.9 PK	68.2	-9.3	1.68 V	352	54.2	4.7
4	11340.00	60.1 PK	74.0	-13.9	2.55 V	231	42.3	17.8
5	11340.00	46.7 AV	54.0	-7.3	2.55 V	231	28.9	17.8

Remarks:

1. Emission Level(dBuV/m) = Raw Value(dBuV) + Correction Factor(dB/m)
2. Correction Factor(dB/m) = Antenna Factor(dB/m) + Cable Factor(dB) – Pre-Amplifier Factor(dB)
3. The other emission levels were very low against the limit.
4. Margin value = Emission Level – Limit value
5. " * ": Fundamental frequency.
6. " # ": The radiated frequency is out of the restricted band.

CHANNEL	TX Channel 142	DETECTOR FUNCTION	Peak (PK)
FREQUENCY RANGE	1GHz ~ 40GHz		Average (AV)

ANTENNA POLARITY & TEST DISTANCE: HORIZONTAL AT 3 M

NO.	FREQ. (MHz)	EMISSION LEVEL (dBuV/m)	LIMIT (dBuV/m)	MARGIN (dB)	ANTENNA HEIGHT (m)	TABLE ANGLE (Degree)	RAW VALUE (dBuV)	CORRECTION FACTOR (dB/m)
1	*5710.00	115.9 PK			3.22 H	7	76.0	39.9
2	*5710.00	105.2 AV			3.22 H	7	65.3	39.9
3	#5850.00	58.9 PK	68.2	-9.3	3.17 H	2	53.6	5.3
4	11420.00	59.6 PK	74.0	-14.4	2.85 H	256	41.9	17.7
5	11420.00	46.5 AV	54.0	-7.5	2.85 H	256	28.8	17.7

ANTENNA POLARITY & TEST DISTANCE: VERTICAL AT 3 M

NO.	FREQ. (MHz)	EMISSION LEVEL (dBuV/m)	LIMIT (dBuV/m)	MARGIN (dB)	ANTENNA HEIGHT (m)	TABLE ANGLE (Degree)	RAW VALUE (dBuV)	CORRECTION FACTOR (dB/m)
1	*5710.00	115.6 PK			1.24 V	312	75.7	39.9
2	*5710.00	104.4 AV			1.24 V	312	64.5	39.9
3	#5850.00	57.9 PK	68.2	-10.3	1.35 V	330	52.6	5.3
4	11420.00	59.5 PK	74.0	-14.5	2.21 V	169	41.8	17.7
5	11420.00	46.4 AV	54.0	-7.6	2.21 V	169	28.7	17.7

Remarks:

1. Emission Level(dBuV/m) = Raw Value(dBuV) + Correction Factor(dB/m)
2. Correction Factor(dB/m) = Antenna Factor(dB/m) + Cable Factor(dB) – Pre-Amplifier Factor(dB)
3. The other emission levels were very low against the limit.
4. Margin value = Emission Level – Limit value
5. " * ": Fundamental frequency.
6. " # ": The radiated frequency is out of the restricted band.

802.11ac (VHT80)

CHANNEL	TX Channel 58	DETECTOR FUNCTION	Peak (PK) Average (AV)
FREQUENCY RANGE	1GHz ~ 40GHz		

ANTENNA POLARITY & TEST DISTANCE: HORIZONTAL AT 3 M								
NO.	FREQ. (MHz)	EMISSION LEVEL (dBuV/m)	LIMIT (dBuV/m)	MARGIN (dB)	ANTENNA HEIGHT (m)	TABLE ANGLE (Degree)	RAW VALUE (dBuV)	CORRECTION FACTOR (dB/m)
1	5150.00	56.6 PK	74.0	-17.4	1.34 H	305	52.2	4.4
2	5150.00	44.3 AV	54.0	-9.7	1.34 H	305	39.9	4.4
3	*5290.00	111.2 PK			1.05 H	304	71.9	39.3
4	*5290.00	100.9 AV			1.05 H	304	61.6	39.3
5	5350.00	65.1 PK	74.0	-8.9	1.21 H	300	60.8	4.3
6	5350.00	52.5 AV	54.0	-1.5	1.21 H	300	48.2	4.3
7	#10580.00	59.7 PK	68.2	-8.5	2.38 H	206	42.0	17.7
ANTENNA POLARITY & TEST DISTANCE: VERTICAL AT 3 M								
NO.	FREQ. (MHz)	EMISSION LEVEL (dBuV/m)	LIMIT (dBuV/m)	MARGIN (dB)	ANTENNA HEIGHT (m)	TABLE ANGLE (Degree)	RAW VALUE (dBuV)	CORRECTION FACTOR (dB/m)
1	5150.00	57.3 PK	74.0	-16.7	1.55 V	352	52.9	4.4
2	5150.00	44.6 AV	54.0	-9.4	1.55 V	352	40.2	4.4
3	*5290.00	111.4 PK			1.65 V	17	72.1	39.3
4	*5290.00	100.0 AV			1.65 V	17	60.7	39.3
5	5350.00	64.9 PK	74.0	-9.1	1.69 V	14	60.6	4.3
6	5350.00	51.9 AV	54.0	-2.1	1.69 V	14	47.6	4.3
7	#10580.00	59.7 PK	68.2	-8.5	2.12 V	193	42.0	17.7

Remarks:

1. Emission Level(dBuV/m) = Raw Value(dBuV) + Correction Factor(dB/m)
2. Correction Factor(dB/m) = Antenna Factor(dB/m) + Cable Factor(dB) – Pre-Amplifier Factor(dB)
3. The other emission levels were very low against the limit.
4. Margin value = Emission Level – Limit value
5. " * ": Fundamental frequency.
6. " # ": The radiated frequency is out of the restricted band.

CHANNEL	TX Channel 106	DETECTOR FUNCTION	Peak (PK)
FREQUENCY RANGE	1GHz ~ 40GHz		Average (AV)

ANTENNA POLARITY & TEST DISTANCE: HORIZONTAL AT 3 M

NO.	FREQ. (MHz)	EMISSION LEVEL (dBuV/m)	LIMIT (dBuV/m)	MARGIN (dB)	ANTENNA HEIGHT (m)	TABLE ANGLE (Degree)	RAW VALUE (dBuV)	CORRECTION FACTOR (dB/m)
1	5460.00	63.5 PK	74.0	-10.5	3.63 H	311	58.9	4.6
2	5460.00	50.4 AV	54.0	-3.6	3.63 H	311	45.8	4.6
3	#5470.00	66.9 PK	68.2	-1.3	3.00 H	333	62.3	4.6
4	*5530.00	112.1 PK			2.74 H	297	72.2	39.9
5	*5530.00	101.1 AV			2.74 H	297	61.2	39.9
6	#5725.00	58.1 PK	68.2	-10.1	2.86 H	310	53.4	4.7
7	11060.00	59.7 PK	74.0	-14.3	2.16 H	183	41.5	18.2
8	11060.00	46.6 AV	54.0	-7.4	2.16 H	183	28.4	18.2

ANTENNA POLARITY & TEST DISTANCE: VERTICAL AT 3 M

NO.	FREQ. (MHz)	EMISSION LEVEL (dBuV/m)	LIMIT (dBuV/m)	MARGIN (dB)	ANTENNA HEIGHT (m)	TABLE ANGLE (Degree)	RAW VALUE (dBuV)	CORRECTION FACTOR (dB/m)
1	5460.00	65.2 PK	74.0	-8.8	2.89 V	328	60.6	4.6
2	5460.00	51.7 AV	54.0	-2.3	2.89 V	328	47.1	4.6
3	#5470.00	66.1 PK	68.2	-2.1	2.82 V	334	61.5	4.6
4	*5530.00	110.4 PK			2.93 V	328	70.5	39.9
5	*5530.00	100.6 AV			2.93 V	328	60.7	39.9
6	#5725.00	57.1 PK	68.2	-11.1	2.96 V	303	52.4	4.7
7	11060.00	60.1 PK	74.0	-13.9	2.03 V	199	41.9	18.2
8	11060.00	46.7 AV	54.0	-7.3	2.03 V	199	28.5	18.2

Remarks:

1. Emission Level(dBuV/m) = Raw Value(dBuV) + Correction Factor(dB/m)
2. Correction Factor(dB/m) = Antenna Factor(dB/m) + Cable Factor(dB) – Pre-Amplifier Factor(dB)
3. The other emission levels were very low against the limit.
4. Margin value = Emission Level – Limit value
5. " * ": Fundamental frequency.
6. " # ": The radiated frequency is out of the restricted band.

CHANNEL	TX Channel 122	DETECTOR FUNCTION	Peak (PK)
FREQUENCY RANGE	1GHz ~ 40GHz		Average (AV)

ANTENNA POLARITY & TEST DISTANCE: HORIZONTAL AT 3 M								
NO.	FREQ. (MHz)	EMISSION LEVEL (dBuV/m)	LIMIT (dBuV/m)	MARGIN (dB)	ANTENNA HEIGHT (m)	TABLE ANGLE (Degree)	RAW VALUE (dBuV)	CORRECTION FACTOR (dB/m)
1	5460.00	55.4 PK	74.0	-18.6	3.21 H	355	50.8	4.6
2	5460.00	44.5 AV	54.0	-9.5	3.21 H	355	39.9	4.6
3	#5470.00	58.4 PK	68.2	-9.8	3.13 H	321	53.8	4.6
4	*5610.00	111.6 PK			3.07 H	6	71.7	39.9
5	*5610.00	101.9 AV			3.07 H	6	62.0	39.9
6	#5825.00	58.6 PK	68.2	-9.6	3.09 H	301	53.4	5.2
7	11220.00	60.9 PK	74.0	-13.1	2.63 H	157	43.0	17.9
8	11220.00	47.5 AV	54.0	-6.5	2.63 H	157	29.6	17.9
ANTENNA POLARITY & TEST DISTANCE: VERTICAL AT 3 M								
NO.	FREQ. (MHz)	EMISSION LEVEL (dBuV/m)	LIMIT (dBuV/m)	MARGIN (dB)	ANTENNA HEIGHT (m)	TABLE ANGLE (Degree)	RAW VALUE (dBuV)	CORRECTION FACTOR (dB/m)
1	5460.00	58.0 PK	74.0	-16.0	1.33 V	341	53.4	4.6
2	5460.00	44.4 AV	54.0	-9.6	1.33 V	341	39.8	4.6
3	#5470.00	58.5 PK	68.2	-9.7	1.64 V	302	53.9	4.6
4	*5610.00	110.3 PK			1.48 V	358	70.4	39.9
5	*5610.00	100.0 AV			1.48 V	358	60.1	39.9
6	#5825.00	59.1 PK	68.2	-9.1	1.65 V	337	53.9	5.2
7	11220.00	60.7 PK	74.0	-13.3	2.38 V	154	42.8	17.9
8	11220.00	47.8 AV	54.0	-6.2	2.38 V	154	29.9	17.9

Remarks:

1. Emission Level(dBuV/m) = Raw Value(dBuV) + Correction Factor(dB/m)
2. Correction Factor(dB/m) = Antenna Factor(dB/m) + Cable Factor(dB) – Pre-Amplifier Factor(dB)
3. The other emission levels were very low against the limit.
4. Margin value = Emission Level – Limit value
5. " * ": Fundamental frequency.
6. " # ": The radiated frequency is out of the restricted band.

CHANNEL	TX Channel 138	DETECTOR FUNCTION	Peak (PK)
FREQUENCY RANGE	1GHz ~ 40GHz		Average (AV)

ANTENNA POLARITY & TEST DISTANCE: HORIZONTAL AT 3 M

NO.	FREQ. (MHz)	EMISSION LEVEL (dBuV/m)	LIMIT (dBuV/m)	MARGIN (dB)	ANTENNA HEIGHT (m)	TABLE ANGLE (Degree)	RAW VALUE (dBuV)	CORRECTION FACTOR (dB/m)
1	5460.00	56.8 PK	74.0	-17.2	3.10 H	10	52.2	4.6
2	5460.00	43.2 AV	54.0	-10.8	3.10 H	10	38.6	4.6
3	#5470.00	57.1 PK	68.2	-11.1	3.01 H	13	52.5	4.6
4	*5690.00	112.7 PK			3.16 H	7	72.8	39.9
5	*5690.00	102.4 AV			3.16 H	7	62.5	39.9
6	#5850.00	59.4 PK	68.2	-8.8	3.21 H	1	54.1	5.3
7	11380.00	60.4 PK	74.0	-13.6	2.88 H	276	42.7	17.7
8	11380.00	47.1 AV	54.0	-6.9	2.88 H	276	29.4	17.7

ANTENNA POLARITY & TEST DISTANCE: VERTICAL AT 3 M

NO.	FREQ. (MHz)	EMISSION LEVEL (dBuV/m)	LIMIT (dBuV/m)	MARGIN (dB)	ANTENNA HEIGHT (m)	TABLE ANGLE (Degree)	RAW VALUE (dBuV)	CORRECTION FACTOR (dB/m)
1	5460.00	56.6 PK	74.0	-17.4	1.30 V	330	52.0	4.6
2	5460.00	43.5 AV	54.0	-10.5	1.30 V	330	38.9	4.6
3	#5470.00	57.1 PK	68.2	-11.1	1.27 V	323	52.5	4.6
4	*5690.00	111.4 PK			1.24 V	312	71.5	39.9
5	*5690.00	100.5 AV			1.24 V	312	60.6	39.9
6	#5850.00	59.2 PK	68.2	-9.0	1.35 V	309	53.9	5.3
7	11380.00	60.6 PK	74.0	-13.4	2.29 V	153	42.9	17.7
8	11380.00	46.9 AV	54.0	-7.1	2.29 V	153	29.2	17.7

Remarks:

1. Emission Level(dBuV/m) = Raw Value(dBuV) + Correction Factor(dB/m)
2. Correction Factor(dB/m) = Antenna Factor(dB/m) + Cable Factor(dB) – Pre-Amplifier Factor(dB)
3. The other emission levels were very low against the limit.
4. Margin value = Emission Level – Limit value
5. " * ": Fundamental frequency.
6. " # ": The radiated frequency is out of the restricted band.

Below 1GHz worst-case data:
802.11ac (VHT80)

CHANNEL	TX Channel 106	DETECTOR FUNCTION	Quasi-Peak (QP)
FREQUENCY RANGE	9kHz ~ 1GHz	TEST MODE	A

ANTENNA POLARITY & TEST DISTANCE: HORIZONTAL AT 3 M								
NO.	FREQ. (MHz)	EMISSION LEVEL (dBuV/m)	LIMIT (dBuV/m)	MARGIN (dB)	ANTENNA HEIGHT (m)	TABLE ANGLE (Degree)	RAW VALUE (dBuV)	CORRECTION FACTOR (dB/m)
1	31.84	29.4 QP	40.0	-10.6	1.99 H	155	40.9	-11.5
2	177.67	28.1 QP	43.5	-15.4	1.49 H	18	38.1	-10.0
3	285.94	44.1 QP	46.0	-1.9	1.00 H	79	51.7	-7.6
4	465.42	38.0 QP	46.0	-8.0	1.99 H	216	42.1	-4.1
5	619.02	39.3 QP	46.0	-6.7	1.00 H	14	40.1	-0.8
6	718.18	42.0 QP	46.0	-4.0	1.49 H	151	41.3	0.7

Remarks:

1. Emission Level(dBuV/m) = Raw Value(dBuV) + Correction Factor(dB/m)
2. Correction Factor(dB/m) = Antenna Factor(dB/m) + Cable Factor(dB) – Pre-Amplifier Factor(dB)
3. The other emission levels were very low against the limit of frequency range 30MHz~1000MHz.
4. Margin value = Emission Level – Limit value
5. The emission levels were very low against the limit of frequency range 9kHz~30MHz: the amplitude of spurious emissions attenuated more than 20dB below the permissible value to be report.

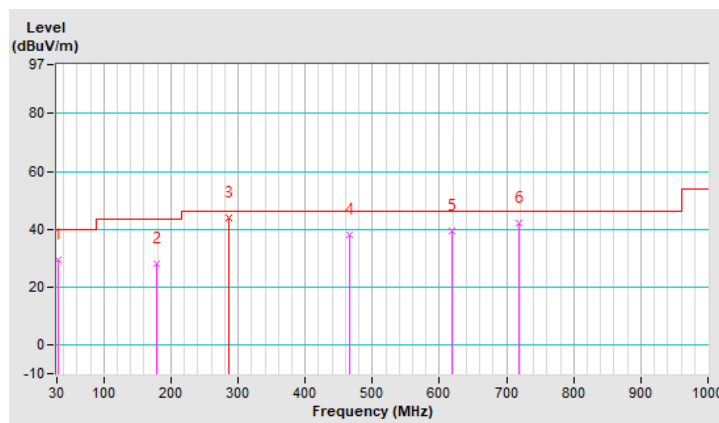

CHANNEL	TX Channel 106	DETECTOR FUNCTION	Quasi-Peak (QP)
FREQUENCY RANGE	9kHz ~ 1GHz	TEST MODE	A

ANTENNA POLARITY & TEST DISTANCE: VERTICAL AT 3 M

NO.	FREQ. (MHz)	EMISSION LEVEL (dBuV/m)	LIMIT (dBuV/m)	MARGIN (dB)	ANTENNA HEIGHT (m)	TABLE ANGLE (Degree)	RAW VALUE (dBuV)	CORRECTION FACTOR (dB/m)
1	31.84	38.5 QP	40.0	-1.5	1.00 V	130	50.0	-11.5
2	51.69	38.6 QP	40.0	-1.4	1.00 V	326	48.3	-9.7
3	259.33	33.1 QP	46.0	-12.9	2.00 V	345	42.0	-8.9
4	430.42	40.4 QP	46.0	-5.6	1.50 V	16	45.0	-4.6
5	500.36	42.4 QP	46.0	-3.6	1.00 V	322	46.0	-3.6
6	751.23	36.8 QP	46.0	-9.2	2.00 V	17	35.0	1.8

Remarks:

1. Emission Level(dBuV/m) = Raw Value(dBuV) + Correction Factor(dB/m)
2. Correction Factor(dB/m) = Antenna Factor(dB/m) + Cable Factor(dB) – Pre-Amplifier Factor(dB)
3. The other emission levels were very low against the limit of frequency range 30MHz~1000MHz.
4. Margin value = Emission Level – Limit value
5. The emission levels were very low against the limit of frequency range 9kHz~30MHz: the amplitude of spurious emissions attenuated more than 20dB below the permissible value to be report.

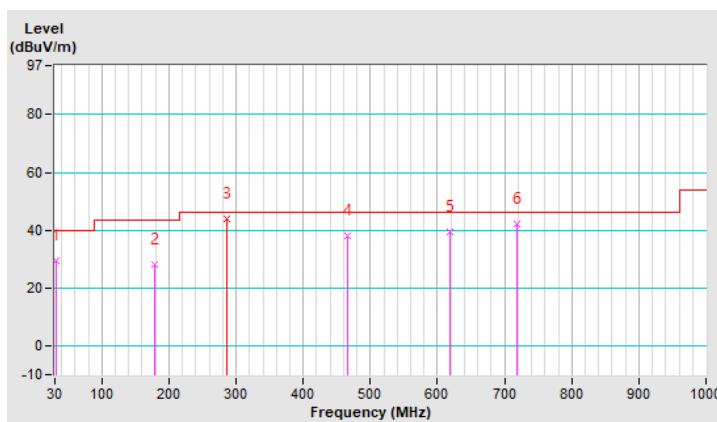

CHANNEL	TX Channel 106	DETECTOR FUNCTION	Quasi-Peak (QP)
FREQUENCY RANGE	9kHz ~ 1GHz	TEST MODE	B

ANTENNA POLARITY & TEST DISTANCE: HORIZONTAL AT 3 M								
NO.	FREQ. (MHz)	EMISSION LEVEL (dBuV/m)	LIMIT (dBuV/m)	MARGIN (dB)	ANTENNA HEIGHT (m)	TABLE ANGLE (Degree)	RAW VALUE (dBuV)	CORRECTION FACTOR (dB/m)
1	30.90	30.8 QP	40.0	-9.2	1.00 H	141	42.4	-11.6
2	288.55	44.4 QP	46.0	-1.6	1.00 H	79	52.0	-7.6
3	500.42	34.6 QP	46.0	-11.4	1.00 H	5	38.2	-3.6
4	624.95	41.5 QP	46.0	-4.5	1.00 H	53	42.2	-0.7
5	751.23	37.0 QP	46.0	-9.0	1.00 H	14	35.2	1.8
6	1000.00	41.0 QP	54.0	-13.0	1.00 H	347	36.0	5.0

Remarks:

1. Emission Level(dBuV/m) = Raw Value(dBuV) + Correction Factor(dB/m)
2. Correction Factor(dB/m) = Antenna Factor(dB/m) + Cable Factor(dB) – Pre-Amplifier Factor(dB)
3. The other emission levels were very low against the limit of frequency range 30MHz~1000MHz.
4. Margin value = Emission Level – Limit value
5. The emission levels were very low against the limit of frequency range 9kHz~30MHz: the amplitude of spurious emissions attenuated more than 20dB below the permissible value to be report.

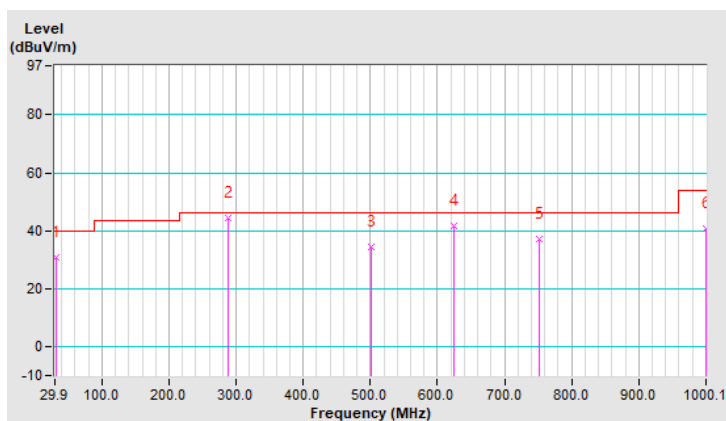

CHANNEL	TX Channel 106	DETECTOR FUNCTION	Quasi-Peak (QP)
FREQUENCY RANGE	9kHz ~ 1GHz	TEST MODE	B

ANTENNA POLARITY & TEST DISTANCE: VERTICAL AT 3 M

NO.	FREQ. (MHz)	EMISSION LEVEL (dBuV/m)	LIMIT (dBuV/m)	MARGIN (dB)	ANTENNA HEIGHT (m)	TABLE ANGLE (Degree)	RAW VALUE (dBuV)	CORRECTION FACTOR (dB/m)
1	30.90	38.5 QP	40.0	-1.5	1.00 V	224	50.1	-11.6
2	286.55	38.0 QP	46.0	-8.0	1.00 V	210	45.6	-7.6
3	436.26	41.1 QP	46.0	-4.9	1.00 V	357	45.6	-4.5
4	500.42	39.5 QP	46.0	-6.5	1.50 V	4	43.1	-3.6
5	749.34	41.6 QP	46.0	-4.4	1.00 V	178	39.8	1.8
6	960.21	38.6 QP	54.0	-15.4	1.00 V	32	33.5	5.1

Remarks:

1. Emission Level(dBuV/m) = Raw Value(dBuV) + Correction Factor(dB/m)
2. Correction Factor(dB/m) = Antenna Factor(dB/m) + Cable Factor(dB) – Pre-Amplifier Factor(dB)
3. The other emission levels were very low against the limit of frequency range 30MHz~1000MHz.
4. Margin value = Emission Level – Limit value
5. The emission levels were very low against the limit of frequency range 9kHz~30MHz: the amplitude of spurious emissions attenuated more than 20dB below the permissible value to be report.

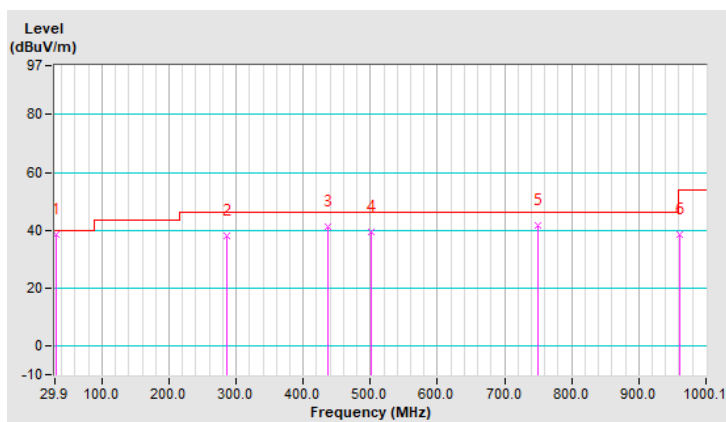

4.2 Conducted Emission Measurement

4.2.1 Limits of Conducted Emission Measurement

Frequency (MHz)	Conducted Limit (dBuV)	
	Quasi-peak	Average
0.15 - 0.5	66 - 56	56 - 46
0.50 - 5.0	56	46
5.0 - 30.0	60	50

Note: 1. The lower limit shall apply at the transition frequencies.

2. The limit decreases in line with the logarithm of the frequency in the range of 0.15 to 0.50MHz.

4.2.2 Test Instruments

Tested date: Apr. 19, 2019

Description & Manufacturer	Model No.	Serial No.	Date Of Calibration	Due Date Of Calibration
Test Receiver ROHDE & SCHWARZ	ESCI	100613	Dec. 10, 2018	Dec. 09, 2019
RF signal cable (with 10dB PAD) Woken	5D-FB	Cable-cond1-01	Sep. 05, 2018	Sep. 04, 2019
LISN ROHDE & SCHWARZ (EUT)	ENV216	101826	Feb. 21, 2019	Feb. 20, 2020
LISN ROHDE & SCHWARZ (Peripheral)	ESH3-Z5	100311	Aug. 19, 2018	Aug. 18, 2019
Software ADT	BV ADT_Cond_ V7.3.7.4	NA	NA	NA

Note: 1. The calibration interval of the above test instruments is 12 months and the calibrations are traceable to NML/ROC and NIST/USA.

2. The test was performed in HwaYa Shielded Room 1.

3. The VCCI Site Registration No. is C-12040.

4.2.3 Test Procedures

- The EUT was placed 0.4 meters from the conducting wall of the shielded room with EUT being connected to the power mains through a line impedance stabilization network (LISN). Other support units were connected to the power mains through another LISN. The two LISNs provide 50 ohm/ 50uH of coupling impedance for the measuring instrument.
- Both lines of the power mains connected to the EUT were checked for maximum conducted interference.
- The frequency range from 150kHz to 30MHz was searched. Emission levels under (Limit - 20dB) was not recorded.

NOTE: The resolution bandwidth and video bandwidth of test receiver is 9kHz for quasi-peak detection (QP) and average detection (AV) at frequency 0.15MHz-30MHz.

4.2.4 Deviation from Test Standard

No deviation.

4.2.5 Test Setup

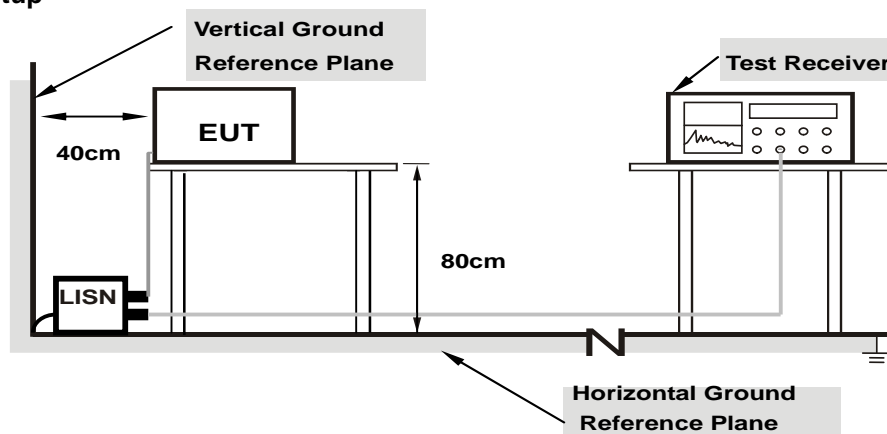

Note: 1.Support units were connected to second LISN.

For the actual test configuration, please refer to the attached file (Test Setup Photo).

4.2.6 EUT Operating Conditions

Same as item 4.1.6.

4.2.7 Test Results

Worst-case data:

802.11ac (VHT80)

Channel	TX Channel 106	Detector Function	Quasi-Peak (QP) / Average (AV)
Phase	Line (L)	Test Mode	A

No	Freq. [MHz]	Corr. Factor (dB)	Reading Value [dB (uV)]		Emission Level [dB (uV)]		Limit [dB (uV)]		Margin (dB)	
			Q.P.	AV.	Q.P.	AV.	Q.P.	AV.	Q.P.	AV.
			1	0.15391	9.69	43.54	25.94	53.23	35.63	65.79
2	0.17744	9.68	42.85	32.73	52.53	42.41	64.60	54.60	-12.07	-12.19
3	0.49017	9.68	36.17	35.40	45.85	45.08	56.16	46.16	-10.31	-1.08
4	0.52821	9.68	32.68	31.68	42.36	41.36	56.00	46.00	-13.64	-4.64
5	1.00202	9.67	30.71	30.06	40.38	39.73	56.00	46.00	-15.62	-6.27
6	6.50375	9.80	23.61	21.60	33.41	31.40	60.00	50.00	-26.59	-18.60

REMARKS:

1. Q.P. and AV. are abbreviations of quasi-peak and average individually.
2. The emission levels of other frequencies were very low against the limit.
3. Margin value = Emission level - Limit value
4. Correction factor = Insertion loss + Cable loss
5. Emission Level = Correction Factor + Reading Value.

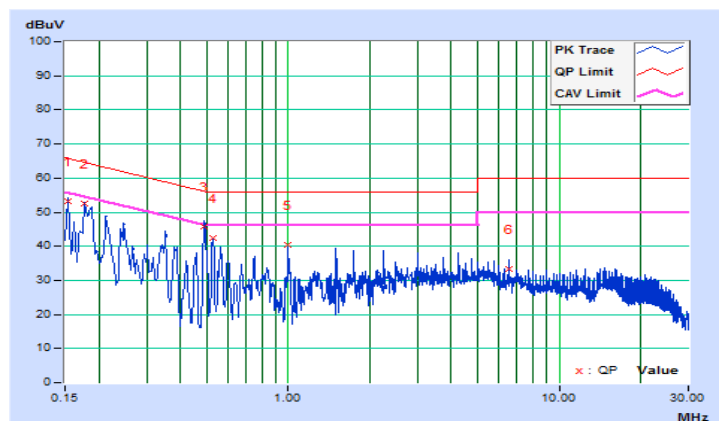

Channel	TX Channel 106	Detector Function	Quasi-Peak (QP) / Average (AV)
Phase	Neutral (N)	Test Mode	A

No	Freq. [MHz]	Corr. Factor (dB)	Reading Value [dB (uV)]		Emission Level [dB (uV)]		Limit [dB (uV)]		Margin (dB)	
			Q.P.	AV.	Q.P.	AV.	Q.P.	AV.	Q.P.	AV.
			1	0.15000	9.66	47.19	34.46	56.85	44.12	66.00
2	0.17744	9.66	40.78	27.59	50.44	37.25	64.60	54.60	-14.16	-17.35
3	0.48935	9.65	32.39	32.03	42.04	41.68	56.18	46.18	-14.14	-4.50
4	0.75214	9.64	29.18	25.64	38.82	35.28	56.00	46.00	-17.18	-10.72
5	2.25358	9.68	30.87	28.40	40.55	38.08	56.00	46.00	-15.45	-7.92
6	5.75694	9.76	25.37	22.03	35.13	31.79	60.00	50.00	-24.87	-18.21

REMARKS:

1. Q.P. and AV. are abbreviations of quasi-peak and average individually.
2. The emission levels of other frequencies were very low against the limit.
3. Margin value = Emission level - Limit value
4. Correction factor = Insertion loss + Cable loss
5. Emission Level = Correction Factor + Reading Value.

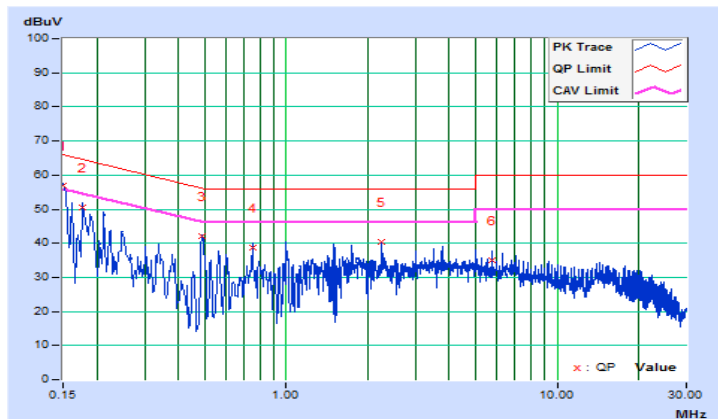

Channel	TX Channel 106	Detector Function	Quasi-Peak (QP) / Average (AV)
Phase	Line (L)	Test Mode	B

No	Freq. [MHz]	Corr. Factor (dB)	Reading Value [dB (uV)]		Emission Level [dB (uV)]		Limit [dB (uV)]		Margin (dB)	
			Q.P.	AV.	Q.P.	AV.	Q.P.	AV.	Q.P.	AV.
			1	0.16173	9.69	45.19	32.55	54.88	42.24	65.37
2	0.17737	9.68	34.12	13.31	43.80	22.99	64.61	54.61	-20.81	-31.62
3	0.48550	9.68	33.01	31.08	42.69	40.76	56.24	46.24	-13.55	-5.48
4	0.56837	9.68	28.55	26.33	38.23	36.01	56.00	46.00	-17.77	-9.99
5	1.01020	9.67	24.43	19.73	34.10	29.40	56.00	46.00	-21.90	-16.60
6	7.10198	9.81	22.08	12.04	31.89	21.85	60.00	50.00	-28.11	-28.15

REMARKS:

1. Q.P. and AV. are abbreviations of quasi-peak and average individually.
2. The emission levels of other frequencies were very low against the limit.
3. Margin value = Emission level - Limit value
4. Correction factor = Insertion loss + Cable loss
5. Emission Level = Correction Factor + Reading Value.

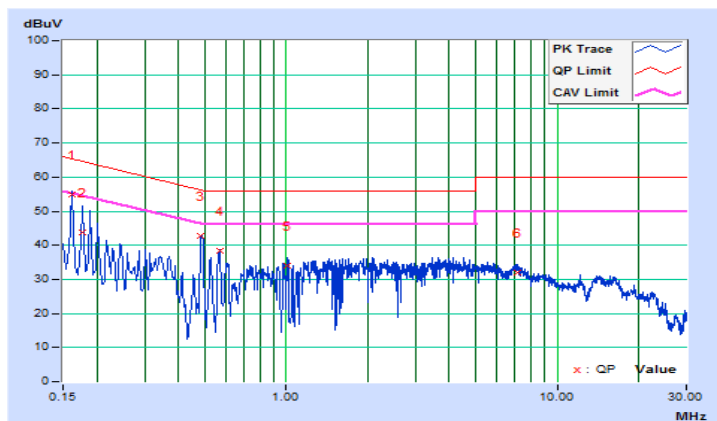

Channel	TX Channel 106	Detector Function	Quasi-Peak (QP) / Average (AV)
Phase	Neutral (N)	Test Mode	B

No	Freq. [MHz]	Corr. Factor (dB)	Reading Value [dB (uV)]		Emission Level [dB (uV)]		Limit [dB (uV)]		Margin (dB)	
			Q.P.	AV.	Q.P.	AV.	Q.P.	AV.	Q.P.	AV.
			1	0.16173	9.66	43.81	25.46	53.47	35.12	65.37
2	0.22434	9.66	36.15	26.27	45.81	35.93	62.66	52.66	-16.85	-16.73
3	0.33750	9.65	34.38	30.26	44.03	39.91	59.26	49.26	-15.23	-9.35
4	0.48550	9.65	36.55	34.83	46.20	44.48	56.24	46.24	-10.04	-1.76
5	0.52544	9.65	33.00	32.47	42.65	42.12	56.00	46.00	-13.35	-3.88
6	6.93385	9.78	20.09	10.93	29.87	20.71	60.00	50.00	-30.13	-29.29

REMARKS:

1. Q.P. and AV. are abbreviations of quasi-peak and average individually.
2. The emission levels of other frequencies were very low against the limit.
3. Margin value = Emission level - Limit value
4. Correction factor = Insertion loss + Cable loss
5. Emission Level = Correction Factor + Reading Value.

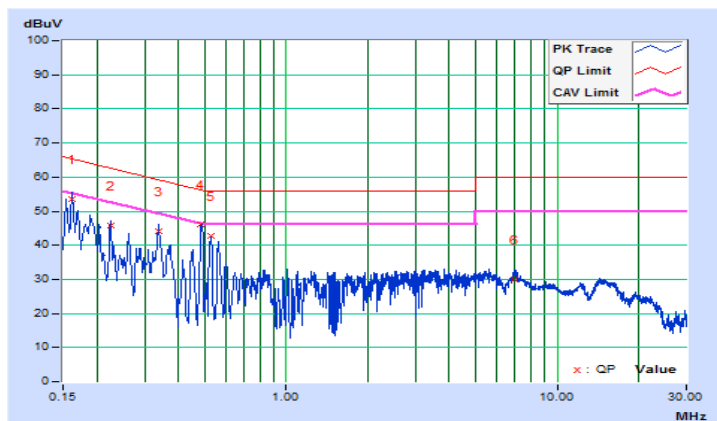

4.3 Transmit Power Measurement

4.3.1 Limits of Transmit Power Measurement

Operation Band	EUT Category		LIMIT
U-NII-1		Outdoor Access Point	1 Watt (30 dBm) (Max. e.i.r.p \leq 125mW(21 dBm) at any elevation angle above 30 degrees as measured from the horizon)
		Fixed point-to-point Access Point	1 Watt (30 dBm)
	√	Indoor Access Point	1 Watt (30 dBm)
		Mobile and Portable client device	250mW (24 dBm)
U-NII-2A		√	250mW (24 dBm) or 11 dBm+10 log B*
U-NII-2C		√	250mW (24 dBm) or 11 dBm+10 log B*
U-NII-3		√	1 Watt (30 dBm)

*B is the 26 dB emission bandwidth in megahertz

Per KDB 662911 Method of conducted output power measurement on IEEE 802.11 devices,

Array Gain = 0 dB (i.e., no array gain) for $N_{ANT} \leq 4$;

Array Gain = 0 dB (i.e., no array gain) for channel widths ≥ 40 MHz for any N_{ANT} ;

Array Gain = $5 \log(N_{ANT}/N_{SS})$ dB or 3 dB, whichever is less for 20-MHz channel widths with $N_{ANT} \geq 5$.

For power measurements on all other devices: Array Gain = $10 \log(N_{ANT}/N_{SS})$ dB.

4.3.2 Test Setup

For Power Output

802.11a, 802.11n (HT20), 802.11n (HT40)

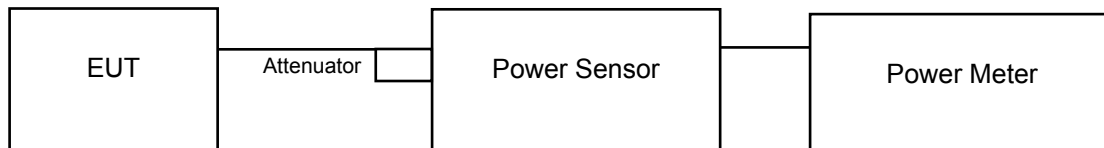

802.11ac (VHT80)

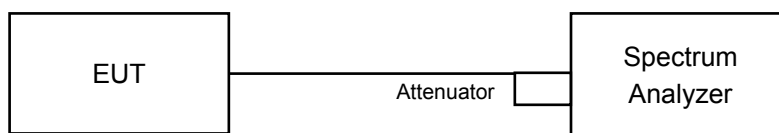

For Bandwidth

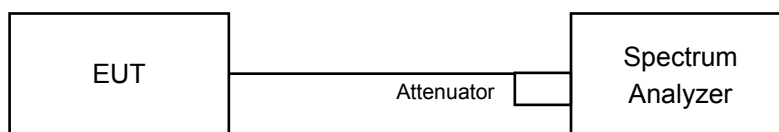

4.3.3 Test Instruments

Refer to section 4.1.2 to get information of above instrument.

4.3.4 Test Procedure

For Average Power Measurement

For 802.11a, 802.11n (HT20), 802.11n (HT40)

Method PM is used to perform output power measurement, trigger and gating function of wide band power meter is enabled to measure max output power of TX on burst. Duty factor is not added to measured value.

For 802.11ac (VHT80)

- a. Set span to encompass the entire 26 dB EBW (or, alternatively, the entire 99% occupied bandwidth) of the signal.
- b. Set sweep trigger to "free run".
- c. Set RBW = 1 MHz
- d. Set VBW \geq 3 MHz
- e. Number of points in sweep \geq 2 Span / RBW
- f. Sweep time \leq (number of points in sweep) * T
- g. Using emission bandwidth to determine the frequency span for integration the channel bandwidth.
- h. Detector = RMS
- i. Trace mode = max hold
- j. Allow max hold to run for at least 60 seconds, or longer as needed to allow the trace to stabilize.
- k. Compute power by integrating the spectrum across the EBW (or, alternatively, the entire 99% occupied bandwidth) of the signal using the instrument's band power measurement function with band limits set equal to the EBW (or occupied bandwidth) band edges. If the instrument does not have a band power function, sum the spectrum levels (in power units) at 1 MHz intervals extending across the EBW (or, alternatively, the entire 99% occupied bandwidth) of the spectrum.

For 26dB Bandwidth

- a. Set RBW = approximately 1% of the emission bandwidth.
- b. Set the VBW > RBW.
- c. Detector = Peak.
- d. Trace mode = max hold.
- e. Measure the maximum width of the emission that is 26 dB down from the peak of the emission. Compare this with the RBW setting of the analyzer. Readjust RBW and repeat measurement as needed until the RBW/EBW ratio is approximately 1%.

4.3.5 Deviation from Test Standard

No deviation.

4.3.6 EUT Operating Conditions

The software provided by client to enable the EUT under transmission condition continuously at lowest, middle and highest channel frequencies individually.

4.3.7 Test Result

Power Output:

For U-NII-2A, U-NII-2C band

CDD Mode

802.11a

Chan.	Freq. (MHz)	Maximum Conducted Power (dBm)				Total Power (mW)	Total Power (dBm)	Power Limit (dBm)	Pass / Fail
		Chain 0	Chain 1	Chain 2	Chain 3				
52	5260	15.68	16.24	15.15	15.69	148.858	21.73	23.93	Pass
60	5300	15.59	16.47	15.01	15.82	150.475	21.77	23.95	Pass
64	5320	15.13	16.00	14.56	15.19	134.008	21.27	23.96	Pass
100	5500	15.57	16.17	15.07	15.84	147.966	21.70	23.88	Pass
116	5580	15.57	15.73	14.45	15.56	137.305	21.38	23.87	Pass
140	5700	15.12	15.39	14.18	15.12	125.794	21.00	23.88	Pass
144	5720 For 5500~5720MHz	13.05	13.66	11.98	12.46	80.070	19.03	22.67	Pass
144	5720 For 5745~5825MHz	7.73	6.76	4.96	7.31	20.002	13.01	30.00	Pass

Note: Gain = 2.1dBi < 6dBi, so the limit no need to be reduced.

For 5260~5320MHz, 5500~5720MHz

Chain 0

1. $11\text{dBm} + 10\log(20.43) = 24.10 > 24\text{dBm}$
2. $11\text{dBm} + 10\log(20.03) = 24.01 > 24\text{dBm}$
3. $11\text{dBm} + 10\log(20.31) = 24.07 > 24\text{dBm}$
4. $11\text{dBm} + 10\log(19.91) = 23.99 < 24\text{dBm}$
5. $11\text{dBm} + 10\log(19.71) = 23.94 < 24\text{dBm}$
6. $11\text{dBm} + 10\log(20.16) = 24.04 > 24\text{dBm}$
7. $11\text{dBm} + 10\log(5725.00 - 5709.84) = 22.80 < 24\text{dBm}$

Chain 1

1. $11\text{dBm} + 10\log(19.66) = 23.93 < 24\text{dBm}$
2. $11\text{dBm} + 10\log(19.76) = 23.95 < 24\text{dBm}$
3. $11\text{dBm} + 10\log(19.78) = 23.96 < 24\text{dBm}$
4. $11\text{dBm} + 10\log(19.42) = 23.88 < 24\text{dBm}$
5. $11\text{dBm} + 10\log(19.39) = 23.87 < 24\text{dBm}$
6. $11\text{dBm} + 10\log(20.24) = 24.06 > 24\text{dBm}$
7. $11\text{dBm} + 10\log(5725.00 - 5709.87) = 22.79 < 24\text{dBm}$

Chain 2

1. $11\text{dBm} + 10\log(19.79) = 23.96 < 24\text{dBm}$
2. $11\text{dBm} + 10\log(20.00) = 24.01 > 24\text{dBm}$
3. $11\text{dBm} + 10\log(19.97) = 24.00 < 24\text{dBm}$
4. $11\text{dBm} + 10\log(19.50) = 23.90 < 24\text{dBm}$
5. $11\text{dBm} + 10\log(19.67) = 23.93 < 24\text{dBm}$
6. $11\text{dBm} + 10\log(19.42) = 23.88 < 24\text{dBm}$
7. $11\text{dBm} + 10\log(5725.00 - 5710.28) = 22.67 < 24\text{dBm}$

Chain 3

1. $11\text{dBm} + 10\log(19.91) = 23.99 < 24\text{dBm}$
2. $11\text{dBm} + 10\log(19.87) = 23.98 < 24\text{dBm}$
3. $11\text{dBm} + 10\log(19.86) = 23.97 < 24\text{dBm}$
4. $11\text{dBm} + 10\log(19.79) = 23.96 < 24\text{dBm}$
5. $11\text{dBm} + 10\log(19.89) = 23.98 < 24\text{dBm}$
6. $11\text{dBm} + 10\log(20.16) = 24.04 > 24\text{dBm}$
7. $11\text{dBm} + 10\log(5725.00 - 5709.99) = 22.76 < 24\text{dBm}$

802.11n (HT20)

Chan.	Freq. (MHz)	Maximum Conducted Power (dBm)				Total Power (mW)	Total Power (dBm)	Power Limit (dBm)	Pass / Fail
		Chain 0	Chain 1	Chain 2	Chain 3				
52	5260	16.02	16.51	15.23	15.97	157.645	21.98	24.00	Pass
60	5300	15.92	16.60	15.14	15.78	155.296	21.91	24.00	Pass
64	5320	15.71	16.45	15.13	15.64	150.624	21.78	24.00	Pass
100	5500	15.82	16.35	15.15	15.97	153.617	21.86	24.00	Pass
116	5580	15.69	15.93	14.63	15.79	143.213	21.56	24.00	Pass
140	5700	15.60	16.07	14.75	15.80	144.639	21.60	24.00	Pass
144	5720 For 5500~5720MHz	13.53	13.70	12.40	13.29	84.692	19.28	22.84	Pass
144	5720 For 5745~5825MHz	8.55	8.89	6.78	8.28	26.400	14.22	30.00	Pass

Note: Gain = 2.1dBi < 6dBi, so the limit no need to be reduced.

For 5260~5320MHz, 5500~5720MHz

Chain 0

1. $11\text{dBm} + 10\log(20.65) = 24.14 > 24\text{dBm}$
2. $11\text{dBm} + 10\log(20.60) = 24.13 > 24\text{dBm}$
3. $11\text{dBm} + 10\log(20.65) = 24.14 > 24\text{dBm}$
4. $11\text{dBm} + 10\log(20.55) = 24.12 > 24\text{dBm}$
5. $11\text{dBm} + 10\log(20.66) = 24.15 > 24\text{dBm}$
6. $11\text{dBm} + 10\log(20.71) = 24.16 > 24\text{dBm}$
7. $11\text{dBm} + 10\log(5725.00 - 5709.71) = 22.84 < 24\text{dBm}$

Chain 1

1. $11\text{dBm} + 10\log(20.54) = 24.12 > 24\text{dBm}$
2. $11\text{dBm} + 10\log(20.58) = 24.13 > 24\text{dBm}$
3. $11\text{dBm} + 10\log(20.59) = 24.13 > 24\text{dBm}$
4. $11\text{dBm} + 10\log(20.44) = 24.10 > 24\text{dBm}$
5. $11\text{dBm} + 10\log(20.42) = 24.10 > 24\text{dBm}$
6. $11\text{dBm} + 10\log(20.83) = 24.18 > 24\text{dBm}$
7. $11\text{dBm} + 10\log(5725.00 - 5709.66) = 22.85 < 24\text{dBm}$

Chain 2

1. $11\text{dBm} + 10\log(20.72) = 24.16 > 24\text{dBm}$
2. $11\text{dBm} + 10\log(20.83) = 24.18 > 24\text{dBm}$
3. $11\text{dBm} + 10\log(20.78) = 24.17 > 24\text{dBm}$
4. $11\text{dBm} + 10\log(20.75) = 24.17 > 24\text{dBm}$
5. $11\text{dBm} + 10\log(20.72) = 24.16 > 24\text{dBm}$
6. $11\text{dBm} + 10\log(20.58) = 24.13 > 24\text{dBm}$
7. $11\text{dBm} + 10\log(5725.00 - 5709.71) = 22.84 < 24\text{dBm}$

Chain 3

1. $11\text{dBm} + 10\log(20.51) = 24.11 > 24\text{dBm}$
2. $11\text{dBm} + 10\log(20.56) = 24.13 > 24\text{dBm}$
3. $11\text{dBm} + 10\log(20.52) = 24.12 > 24\text{dBm}$
4. $11\text{dBm} + 10\log(20.48) = 24.11 > 24\text{dBm}$
5. $11\text{dBm} + 10\log(20.51) = 24.11 > 24\text{dBm}$
6. $11\text{dBm} + 10\log(20.68) = 24.15 > 24\text{dBm}$
7. $11\text{dBm} + 10\log(5725.00 - 5709.70) = 22.84 < 24\text{dBm}$

802.11n (HT40)

Chan.	Freq. (MHz)	Maximum Conducted Power (dBm)				Total Power (mW)	Total Power (dBm)	Power Limit (dBm)	Pass / Fail
		Chain 0	Chain 1	Chain 2	Chain 3				
54	5270	17.55	18.19	16.89	17.51	228.031	23.58	24.00	Pass
62	5310	17.19	18.57	16.80	17.59	229.580	23.61	24.00	Pass
102	5510	17.49	18.01	16.85	17.69	226.512	23.55	24.00	Pass
110	5550	17.82	18.14	16.88	17.73	233.743	23.69	24.00	Pass
134	5670	17.49	17.59	16.59	17.49	215.226	23.33	24.00	Pass
142	5710 For 5500~5720MHz	15.39	16.21	14.74	15.99	150.698	21.78	24.00	Pass
142	5710 For 5745~5825MHz	4.90	4.76	5.49	4.90	13.132	11.18	30.00	Pass

Note: Gain = 2.1dBi < 6dBi, so the limit no need to be reduced.

For 5260~5320MHz, 5500~5720MHz

Chain 0

1. $11\text{dBm} + 10\log(40.73) = 27.09 > 24\text{dBm}$
2. $11\text{dBm} + 10\log(40.80) = 27.10 > 24\text{dBm}$
3. $11\text{dBm} + 10\log(40.70) = 27.09 > 24\text{dBm}$
4. $11\text{dBm} + 10\log(40.87) = 27.11 > 24\text{dBm}$
5. $11\text{dBm} + 10\log(40.74) = 27.10 > 24\text{dBm}$
6. $11\text{dBm} + 10\log(5725.00 - 5689.83) = 26.46 > 24\text{dBm}$

Chain 1

1. $11\text{dBm} + 10\log(40.75) = 27.10 > 24\text{dBm}$
2. $11\text{dBm} + 10\log(40.55) = 27.07 > 24\text{dBm}$
3. $11\text{dBm} + 10\log(40.74) = 27.10 > 24\text{dBm}$
4. $11\text{dBm} + 10\log(40.88) = 27.11 > 24\text{dBm}$
5. $11\text{dBm} + 10\log(40.78) = 27.10 > 24\text{dBm}$
6. $11\text{dBm} + 10\log(5725.00 - 5689.71) = 26.47 > 24\text{dBm}$

Chain 2

1. $11\text{dBm} + 10\log(40.61) = 27.08 > 24\text{dBm}$
2. $11\text{dBm} + 10\log(40.47) = 27.07 > 24\text{dBm}$
3. $11\text{dBm} + 10\log(40.80) = 27.10 > 24\text{dBm}$
4. $11\text{dBm} + 10\log(40.81) = 27.10 > 24\text{dBm}$
5. $11\text{dBm} + 10\log(40.66) = 27.09 > 24\text{dBm}$
6. $11\text{dBm} + 10\log(5725.00 - 5689.81) = 26.46 > 24\text{dBm}$

Chain 3

1. $11\text{dBm} + 10\log(40.59) = 27.08 > 24\text{dBm}$
2. $11\text{dBm} + 10\log(40.53) = 27.07 > 24\text{dBm}$
3. $11\text{dBm} + 10\log(40.48) = 27.07 > 24\text{dBm}$
4. $11\text{dBm} + 10\log(40.48) = 27.07 > 24\text{dBm}$
5. $11\text{dBm} + 10\log(40.51) = 27.07 > 24\text{dBm}$
6. $11\text{dBm} + 10\log(5725.00 - 5689.90) = 26.45 > 24\text{dBm}$

802.11ac (VHT80)

Chan.	Freq. (MHz)	Maximum Conducted Power (dBm)				Total Power (mW)	Total Power (dBm)	Power Limit (dBm)	Pass / Fail
		Chain 0	Chain 1	Chain 2	Chain 3				
58	5290	17.55	18.39	17.03	17.75	235.941	23.73	24.00	Pass
106	5530	17.85	18.31	17.13	17.92	242.304	23.84	24.00	Pass
122	5610	17.94	18.13	17.15	17.85	240.077	23.80	24.00	Pass
138	5690 For 5500~5720MHz	15.02	15.31	14.59	14.89	133.782	21.26	24.00	Pass
138	5690 For 5745~5825MHz	0.51	1.04	-0.38	0.79	4.8148	6.83	30.00	Pass

Note: Gain = 2.1dBi < 6dBi, so the limit no need to be reduced.

For 5260~5320MHz, 5500~5720MHz

Chain 0

1. $11\text{dBm} + 10\log(83.88) = 30.23 > 24\text{dBm}$
2. $11\text{dBm} + 10\log(84.05) = 30.24 > 24\text{dBm}$
3. $11\text{dBm} + 10\log(84.14) = 30.25 > 24\text{dBm}$
4. $11\text{dBm} + 10\log(5725.00 - 5648.11) = 29.85 > 24\text{dBm}$

Chain 1

1. $11\text{dBm} + 10\log(83.62) = 30.22 > 24\text{dBm}$
2. $11\text{dBm} + 10\log(83.90) = 30.23 > 24\text{dBm}$
3. $11\text{dBm} + 10\log(83.99) = 30.24 > 24\text{dBm}$
4. $11\text{dBm} + 10\log(5725.00 - 5648.38) = 29.84 > 24\text{dBm}$

Chain 2

1. $11\text{dBm} + 10\log(84.17) = 30.25 > 24\text{dBm}$
2. $11\text{dBm} + 10\log(84.28) = 30.25 > 24\text{dBm}$
3. $11\text{dBm} + 10\log(84.35) = 30.26 > 24\text{dBm}$
4. $11\text{dBm} + 10\log(5725.00 - 5648.12) = 29.85 > 24\text{dBm}$

Chain 3

1. $11\text{dBm} + 10\log(83.80) = 30.23 > 24\text{dBm}$
2. $11\text{dBm} + 10\log(83.61) = 30.22 > 24\text{dBm}$
3. $11\text{dBm} + 10\log(83.75) = 30.22 > 24\text{dBm}$
4. $11\text{dBm} + 10\log(5725.00 - 5648.65) = 29.82 > 24\text{dBm}$

Beamforming Mode

802.11n (HT20)

Chan.	Freq. (MHz)	Maximum Conducted Power (dBm)				Total Power (mW)	Total Power (dBm)	Power Limit (dBm)	Pass / Fail
		Chain 0	Chain 1	Chain 2	Chain 3				
52	5260	10.00	10.49	9.21	9.95	39.417	15.96	21.88	Pass
60	5300	9.90	10.58	9.12	9.76	38.829	15.89	21.88	Pass
64	5320	9.69	10.43	9.11	9.62	37.661	15.76	21.88	Pass
100	5500	9.80	10.33	9.13	9.95	38.410	15.84	21.88	Pass
116	5580	9.67	9.91	8.61	9.77	35.808	15.54	21.88	Pass
140	5700	9.58	10.05	8.73	9.78	36.164	15.58	21.88	Pass
144	5720 For 5500~5720MHz	7.51	7.68	6.38	7.27	21.175	13.26	21.88	Pass
144	5720 For 5745~5825MHz	2.53	2.87	0.76	2.26	6.601	8.20	27.88	Pass

Note:

5260~5320MHz & 5500~5700MHz: Directional Gain = 2.1dBi + 10log(4)=8.12dBi > 6dBi , so the conducted power limit shall be reduced to 24-(8.12-6)=21.88dBm
 5745~5825MHz: Directional Gain = 2.1dBi + 10log(4)=8.12dBi > 6dBi , so the conducted power limit shall be reduced to 30-(8.12-6)=27.88dBm

For 5260~5320MHz, 5500~5720MHz

Chain 0

1. 11dBm + 10log (20.65) = 24.14 > 21.88dBm
2. 11dBm + 10log (20.60) = 24.13 > 21.88dBm
3. 11dBm + 10log (20.65) = 24.14 > 21.88dBm
4. 11dBm + 10log (20.55) = 24.12 > 21.88dBm
5. 11dBm + 10log (20.66) = 24.15 > 21.88dBm
6. 11dBm + 10log (20.71) = 24.16 > 21.88dBm
7. 11dBm + 10log (5725.00 - 5709.71) = 22.84 > 21.88dBm

Chain 1

1. 11dBm + 10log (20.54) = 24.12 > 21.88dBm
2. 11dBm + 10log (20.58) = 24.13 > 21.88dBm
3. 11dBm + 10log (20.59) = 24.13 > 21.88dBm
4. 11dBm + 10log (20.44) = 24.10 > 21.88dBm
5. 11dBm + 10log (20.42) = 24.10 > 21.88dBm
6. 11dBm + 10log (20.83) = 24.18 > 21.88dBm
7. 11dBm + 10log (5725.00 - 5709.66) = 22.85 > 21.88dBm

Chain 2

1. $11\text{dBm} + 10\log(20.72) = 24.16 > 21.88\text{dBm}$
2. $11\text{dBm} + 10\log(20.83) = 24.18 > 21.88\text{dBm}$
3. $11\text{dBm} + 10\log(20.78) = 24.17 > 21.88\text{dBm}$
4. $11\text{dBm} + 10\log(20.75) = 24.17 > 21.88\text{dBm}$
5. $11\text{dBm} + 10\log(20.72) = 24.16 > 21.88\text{dBm}$
6. $11\text{dBm} + 10\log(20.58) = 24.13 > 21.88\text{dBm}$
7. $11\text{dBm} + 10\log(5725.00 - 5709.71) = 22.84 > 21.88\text{dBm}$

Chain 3

1. $11\text{dBm} + 10\log(20.51) = 24.11 > 21.88\text{dBm}$
2. $11\text{dBm} + 10\log(20.56) = 24.13 > 21.88\text{dBm}$
3. $11\text{dBm} + 10\log(20.52) = 24.12 > 21.88\text{dBm}$
4. $11\text{dBm} + 10\log(20.48) = 24.11 > 21.88\text{dBm}$
5. $11\text{dBm} + 10\log(20.51) = 24.11 > 21.88\text{dBm}$
6. $11\text{dBm} + 10\log(20.68) = 24.15 > 21.88\text{dBm}$
7. $11\text{dBm} + 10\log(5725.00 - 5709.70) = 22.84 > 21.88\text{dBm}$

802.11n (HT40)

Chan.	Freq. (MHz)	Maximum Conducted Power (dBm)				Total Power (mW)	Total Power (dBm)	Power Limit (dBm)	Pass / Fail
		Chain 0	Chain 1	Chain 2	Chain 3				
54	5270	11.53	12.17	10.87	11.49	57.016	17.56	21.88	Pass
62	5310	11.17	12.55	10.78	11.57	57.403	17.59	21.88	Pass
102	5510	11.47	11.99	10.83	11.67	56.635	17.53	21.88	Pass
110	5550	11.80	12.12	10.86	11.71	58.444	17.67	21.88	Pass
134	5670	11.47	11.57	10.57	11.47	53.813	17.31	21.88	Pass
142	5710 For 5500~5720MHz	9.37	10.19	8.72	9.97	37.679	15.76	21.88	Pass
142	5710 For 5745~5825MHz	-1.12	-1.26	-0.53	-1.12	3.2837	5.16	27.88	Pass

Note:

5260~5320MHz & 5500~5700MHz: Directional Gain = 2.1dBi + 10log(4)=8.12dBi > 6dBi , so the conducted power limit shall be reduced to 24-(8.12-6)=21.88dBm

5745~5825MHz: Directional Gain = 2.1dBi + 10log(4)=8.12dBi > 6dBi , so the conducted power limit shall be reduced to 30-(8.12-6)=27.88dBm

For 5260~5320MHz, 5500~5720MHz

Chain 0

1. 11dBm + 10log (40.73) = 27.09 > 21.88dBm
2. 11dBm + 10log (40.80) = 27.10 > 21.88dBm
3. 11dBm + 10log (40.70) = 27.09 > 21.88dBm
4. 11dBm + 10log (40.87) = 27.11 > 21.88dBm
5. 11dBm + 10log (40.74) = 27.10 > 21.88dBm
6. 11dBm + 10log (5725.00 - 5689.83) = 26.46 > 21.88dBm

Chain 1

1. 11dBm + 10log (40.75) = 27.10 > 21.88dBm
2. 11dBm + 10log (40.55) = 27.07 > 21.88dBm
3. 11dBm + 10log (40.74) = 27.10 > 21.88dBm
4. 11dBm + 10log (40.88) = 27.11 > 21.88dBm
5. 11dBm + 10log (40.78) = 27.10 > 21.88dBm
6. 11dBm + 10log (5725.00 - 5689.71) = 26.47 > 21.88dBm

Chain 2

1. 11dBm + 10log (40.61) = 27.08 > 21.88dBm
2. 11dBm + 10log (40.47) = 27.07 > 21.88dBm
3. 11dBm + 10log (40.80) = 27.10 > 21.88dBm
4. 11dBm + 10log (40.81) = 27.10 > 21.88dBm
5. 11dBm + 10log (40.66) = 27.09 > 21.88dBm
6. 11dBm + 10log (5725.00 - 5689.81) = 26.46 > 21.88dBm

Chain 3

1. $11\text{dBm} + 10\log(40.59) = 27.08 > 21.88\text{dBm}$
2. $11\text{dBm} + 10\log(40.53) = 27.07 > 21.88\text{dBm}$
3. $11\text{dBm} + 10\log(40.48) = 27.07 > 21.88\text{dBm}$
4. $11\text{dBm} + 10\log(40.48) = 27.07 > 21.88\text{dBm}$
5. $11\text{dBm} + 10\log(40.51) = 27.07 > 24\text{dBm}$
6. $11\text{dBm} + 10\log(5725.00 - 5689.90) = 26.45 > 21.88\text{dBm}$

802.11ac (VHT80)

Chan.	Freq. (MHz)	Maximum Conducted Power (dBm)				Total Power (mW)	Total Power (dBm)	Power Limit (dBm)	Pass / Fail
		Chain 0	Chain 1	Chain 2	Chain 3				
58	5290	11.53	12.37	11.01	11.73	58.993	17.71	21.88	Pass
106	5530	11.83	12.29	11.11	11.90	60.584	17.82	21.88	Pass
122	5610	11.92	12.11	11.13	11.83	60.028	17.78	21.88	Pass
138	5690 For 5500~5720MHz	9.00	9.29	8.57	8.87	33.449	15.24	21.88	Pass
138	5690 For 5745~5825MHz	-5.51	-4.98	-6.40	-5.23	1.204	0.81	27.88	Pass

Note:

5260~5320MHz & 5500~5700MHz: Directional Gain = 2.1dBi + 10log(4)=8.12dBi > 6dBi , so the conducted power limit shall be reduced to 24-(8.12-6)=21.88dBm
 5745~5825MHz: Directional Gain = 2.1dBi + 10log(4)=8.12dBi > 6dBi , so the conducted power limit shall be reduced to 30-(8.12-6)=27.88dBm

For 5260~5320MHz, 5500~5720MHz

Chain 0

1. 11dBm + 10log (83.88) = 30.23 > 21.88dBm
2. 11dBm + 10log (84.05) = 30.24 > 21.88dBm
3. 11dBm + 10log (84.14) = 30.25 > 21.88dBm
4. 11dBm + 10log (5725.00 - 5648.11) = 29.85 > 21.88dBm

Chain 1

1. 11dBm + 10log (83.62) = 30.22 > 21.88dBm
2. 11dBm + 10log (83.90) = 30.23 > 21.88dBm
3. 11dBm + 10log (83.99) = 30.24 > 21.88dBm
4. 11dBm + 10log (5725.00 - 5648.38) = 29.84 > 21.88dBm

Chain 2

1. 11dBm + 10log (84.17) = 30.25 > 21.88dBm
2. 11dBm + 10log (84.28) = 30.25 > 21.88dBm
3. 11dBm + 10log (84.35) = 30.26 > 21.88dBm
4. 11dBm + 10log (5725.00 - 5648.12) = 29.85 > 21.88dBm

Chain 3

1. 11dBm + 10log (83.80) = 30.23 > 21.88dBm
2. 11dBm + 10log (83.61) = 30.22 > 21.88dBm
3. 11dBm + 10log (83.75) = 30.22 > 21.88dBm
4. 11dBm + 10log (5725.00 - 5648.65) = 29.82 > 21.88dBm

For U-NII-2A, U-NII-2C band

802.11a

Channel	Frequency (MHz)	26dBc Bandwidth (MHz)			
		Chain 0	Chain 1	Chain 2	Chain 3
52	5260	20.43	19.66	19.79	19.91
60	5300	20.03	19.76	20.00	19.87
64	5320	20.31	19.78	19.97	19.86
100	5500	19.91	19.42	19.50	19.79
116	5580	19.71	19.39	19.67	19.89
140	5700	20.16	20.24	19.42	20.16
144	5720 For 5500~5720MHz	15.16	15.13	14.72	15.01
144	5720 For 5745~5825MHz	4.96	5.20	4.77	5.23

802.11n (HT20)

Channel	Frequency (MHz)	26dBc Bandwidth (MHz)			
		Chain 0	Chain 1	Chain 2	Chain 3
52	5260	20.65	20.54	20.72	20.51
60	5300	20.60	20.58	20.83	20.56
64	5320	20.65	20.59	20.78	20.52
100	5500	20.55	20.44	20.75	20.48
116	5580	20.66	20.42	20.72	20.51
140	5700	20.71	20.83	20.58	20.68
144	5720 For 5500~5720MHz	15.29	15.34	15.29	15.30
144	5720 For 5745~5825MHz	5.40	5.56	5.44	5.33

802.11n (HT40)

Channel	Frequency (MHz)	26dBc Bandwidth (MHz)			
		Chain 0	Chain 1	Chain 2	Chain 3
54	5270	40.73	40.75	40.61	40.59
62	5310	40.80	40.55	40.47	40.53
102	5510	40.70	40.74	40.80	40.48
110	5550	40.87	40.88	40.81	40.48
134	5670	40.74	40.78	40.66	40.51
142	5710 For 5500~5720MHz	35.17	35.29	35.19	35.10
142	5710 For 5745~5825MHz	5.39	5.36	5.35	5.18

802.11ac (VHT80)

Channel	Frequency (MHz)	26dBc Bandwidth (MHz)			
		Chain 0	Chain 1	Chain 2	Chain 3
58	5290	83.88	83.62	84.17	83.80
106	5530	84.05	83.90	84.28	83.61
122	5610	84.14	83.99	84.35	83.75
138	5690 For 5500~5720MHz	76.89	76.62	76.88	76.35
138	5690 For 5745~5825MHz	7.00	7.31	7.17	6.60

Spectrum Plot of Worst Value

802.11a

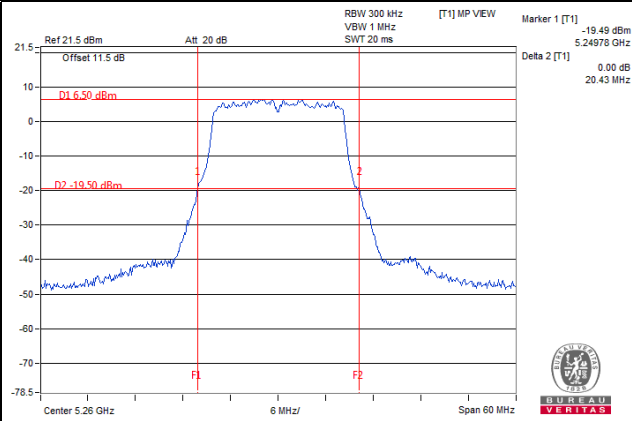

802.11n (HT20)

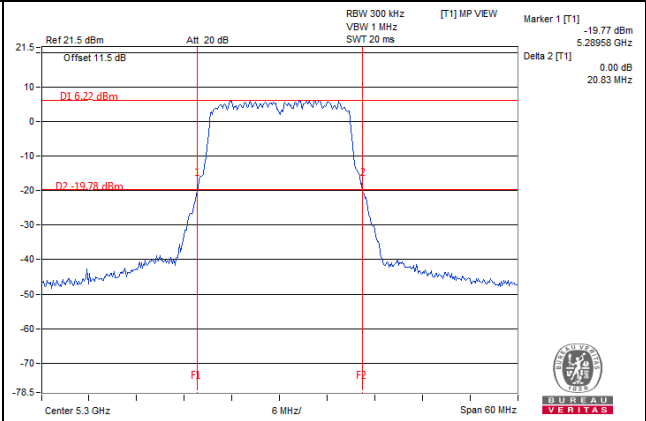

802.11n (HT40)

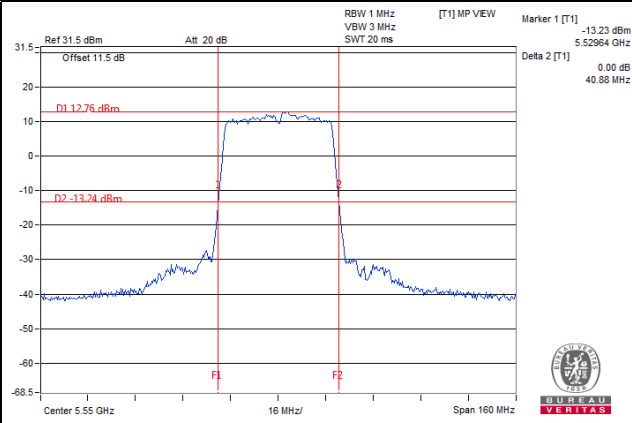

802.11ac (VHT80)

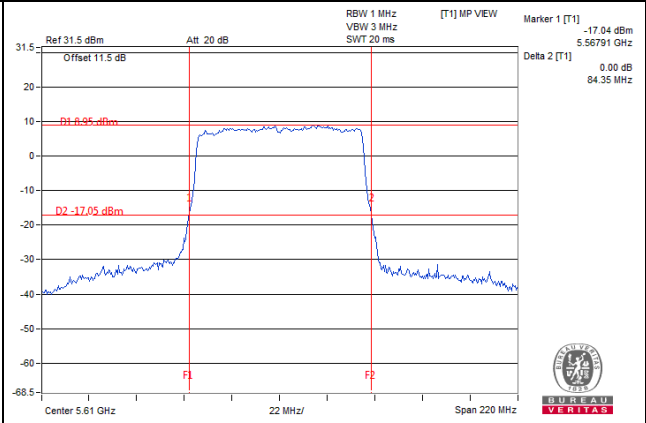

EUT Maximum Conducted Power

CDD Mode

802.11a

Frequency Band (MHz)	Max. Power	
	Output Power (mW)	Output Power (dBm)
5250~5350	150.475	21.77
5470~5725	147.966	21.70

Note: Manufacturer provides Transmit Power Control description to meet this requirement.

802.11n (HT20)

Frequency Band (MHz)	Max. Power	
	Output Power (mW)	Output Power (dBm)
5250~5350	157.645	21.98
5470~5725	153.617	21.86

Note: Manufacturer provides Transmit Power Control description to meet this requirement.

802.11n (HT40)

Frequency Band (MHz)	Max. Power	
	Output Power (mW)	Output Power (dBm)
5250~5350	229.580	23.61
5470~5725	233.743	23.69

Note: Manufacturer provides Transmit Power Control description to meet this requirement.

802.11ac (VHT80)

Frequency Band (MHz)	Max. Power	
	Output Power (mW)	Output Power (dBm)
5250~5350	235.941	23.73
5470~5725	242.304	23.84

Note: Manufacturer provides Transmit Power Control description to meet this requirement.

Beamforming Mode

802.11n (HT20)

Frequency Band (MHz)	Max. Power	
	Output Power (mW)	Output Power (dBm)
5250~5350	39.417	15.96
5470~5725	38.410	15.84

Note: Manufacturer provides Transmit Power Control description to meet this requirement.

802.11n (HT40)

Frequency Band (MHz)	Max. Power	
	Output Power (mW)	Output Power (dBm)
5250~5350	57.403	17.59
5470~5725	58.444	17.67

Note: Manufacturer provides Transmit Power Control description to meet this requirement.

802.11ac (VHT80)

Frequency Band (MHz)	Max. Power	
	Output Power (mW)	Output Power (dBm)
5250~5350	58.993	17.71
5470~5725	60.584	17.82

Note: Manufacturer provides Transmit Power Control description to meet this requirement.

4.4 Occupied Bandwidth Measurement

4.4.1 Test Setup

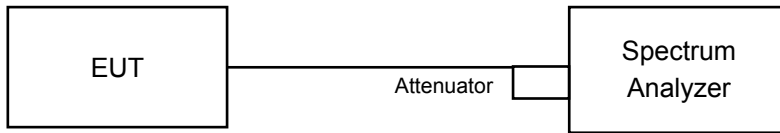

4.4.2 Test Instruments

Refer to section 4.1.2 to get information of above instrument.

4.4.3 Test Procedure

The transmitter output was connected to the spectrum analyzer through an attenuator. The bandwidth of the fundamental frequency was measured by spectrum analyzer with resolution bandwidth in the range of 1% to 5% of the anticipated emission bandwidth, and a video bandwidth at least 3x the resolution bandwidth and set the detector to sampling. The width of a frequency band such that, below the lower and above the upper frequency limits, the mean powers emitted are each equal to a specified percentage 0.5 %of the total mean power of a given emission.

4.4.4 Test Result

For U-NII-2A, U-NII-2C band

802.11a

Channel	Frequency (MHz)	Occupied Bandwidth (MHz)			
		Chain 0	Chain 1	Chain 2	Chain 3
52	5260	16.56	16.44	16.56	16.56
60	5300	16.56	16.44	16.56	16.44
64	5320	16.56	16.44	16.56	16.44
100	5500	16.44	16.44	16.44	16.44
116	5580	16.44	16.44	16.44	16.44
140	5700	16.56	16.56	16.32	16.56
144	5720 For 5500~5720MHz	13.16	13.28	13.16	13.28
144	5720 For 5745~5825MHz	3.16	3.16	3.16	3.16

802.11n (HT20)

Channel	Frequency (MHz)	Occupied Bandwidth (MHz)			
		Chain 0	Chain 1	Chain 2	Chain 3
52	5260	17.64	17.64	17.64	17.64
60	5300	17.64	17.64	17.64	17.52
64	5320	17.64	17.64	17.64	17.52
100	5500	17.52	17.52	17.64	17.64
116	5580	17.64	17.52	17.64	17.64
140	5700	17.64	17.64	17.64	17.64
144	5720 For 5500~5720MHz	13.76	13.88	13.76	13.88
144	5720 For 5745~5825MHz	3.76	3.76	3.76	3.76

802.11n (HT40)

Channel	Frequency (MHz)	Occupied Bandwidth (MHz)			
		Chain 0	Chain 1	Chain 2	Chain 3
54	5270	36.12	35.88	36.00	36.12
62	5310	36.12	36.00	36.00	36.12
102	5510	36.12	36.12	36.12	36.12
110	5550	36.12	36.24	36.12	36.00
134	5670	36.12	36.00	36.12	35.88
142	5710 For 5500~5720MHz	33.00	32.88	33.00	32.88
142	5710 For 5745~5825MHz	3.12	3.00	3.12	3.00

802.11ac (VHT80)

Channel	Frequency (MHz)	Occupied Bandwidth (MHz)			
		Chain 0	Chain 1	Chain 2	Chain 3
58	5290	75.84	75.84	76.08	75.84
106	5530	75.84	76.08	75.84	75.84
122	5610	75.84	76.08	76.08	75.84
138	5690 For 5500~5720MHz	72.92	72.92	72.92	72.92
138	5690 For 5745~5825MHz	2.92	2.92	2.92	2.92

Spectrum Plot of Worst Value

802.11a

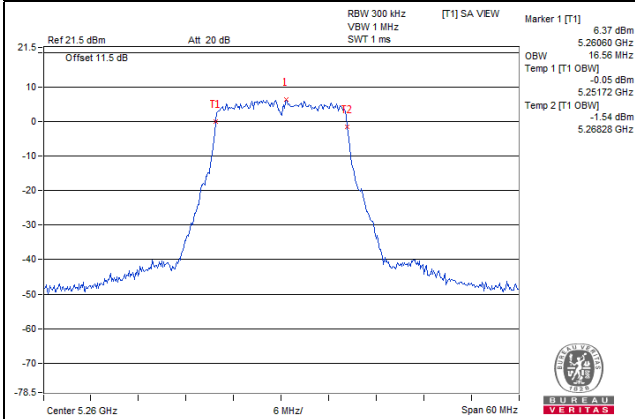

802.11n (HT20)

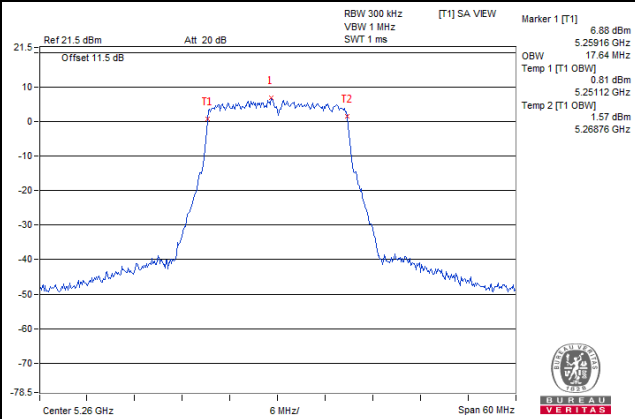

802.11n (HT40)

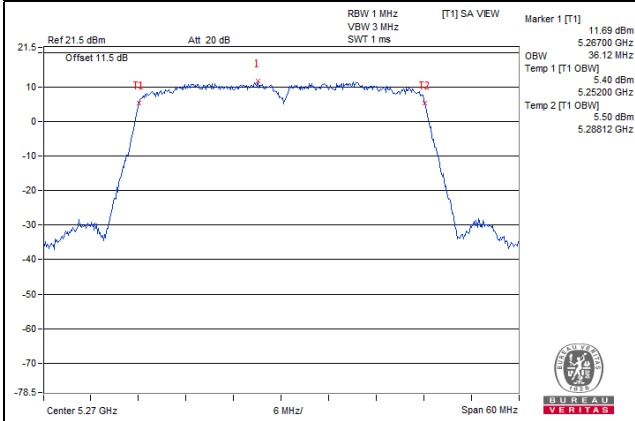

802.11ac (VHT80)

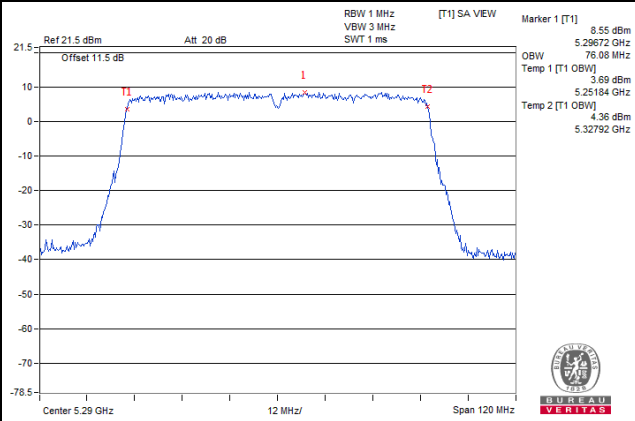

4.5 Peak Power Spectral Density Measurement

4.5.1 Limits of Peak Power Spectral Density Measurement

Operation Band	EUT Category		LIMIT
U-NII-1		Outdoor Access Point	17dBm/ MHz
		Fixed point-to-point Access Point	
	√	Indoor Access Point	
		Mobile and Portable client devise	11dBm/ MHz
U-NII-2A		√	11dBm/ MHz
U-NII-2C		√	11dBm/ MHz
U-NII-3		√	30dBm/ 500kHz

4.5.2 Test Setup

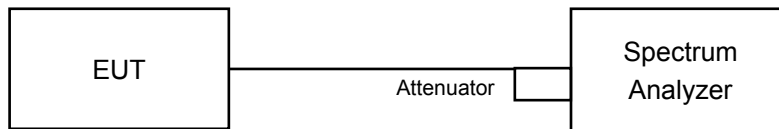

4.5.3 Test Instruments

Refer to section 4.1.2 to get information of above instrument.

4.5.4 Test Procedures

For U-NII-1, U-NII-2A, U-NII-2C band

Duty cycle of test signal is $\geq 98\%$

Using method SA-1

- 1) Set span to encompass the entire emission bandwidth (EBW) of the signal.
- 2) Set RBW = 1MHz, Set VBW ≥ 3 MHz, Detector = RMS.
- 3) Set Channel power measure = 1MHz.
- 4) Sweep time = auto, trigger set to "free run".
- 5) Trace average at least 100 traces in power averaging mode.
- 6) Record the max value.

Duty cycle of test signal is $< 98\%$

Using method SA-2

- 1) Set span to encompass the entire emission bandwidth (EBW) of the signal.
- 2) Set RBW = 1MHz, Set VBW ≥ 3 MHz, Detector = RMS.
- 3) Set Channel power measure = 1MHz.
- 4) Sweep time = auto, trigger set to "free run".
- 5) Trace average at least 100 traces in power averaging mode.
- 6) Record the max value and add $10 \log (1/\text{duty cycle})$.

For U-NII-3 band

Duty cycle $\geq 98\%$

- 1) Set span to encompass the entire emission bandwidth (EBW) of the signal.
- 2) Set RBW = 300 kHz, Set VBW ≥ 1 MHz, Detector = RMS.
- 3) Use the peak marker function to determine the maximum power level in any 300 kHz band segment within the fundamental EBW.
- 4) Scale the observed power level to an equivalent value in 500 kHz by adjusting (reducing) the measured power by a bandwidth correction factor (BWCF) where $BWCF = 10\log(500 \text{ kHz} / 300 \text{ kHz})$.
- 5) Sweep time = auto, trigger set to "free run".
- 6) Trace average at least 100 traces in power averaging mode.
- 7) Record the max value.

Duty cycle $< 98\%$

- 1) Set span to encompass the entire emission bandwidth (EBW) of the signal.
- 2) Set RBW = 300 kHz, Set VBW ≥ 1 MHz, Detector = RMS
- 3) Use the peak marker function to determine the maximum power level in any 300 kHz band segment within the fundamental EBW.
- 4) Scale the observed power level to an equivalent value in 500 kHz by adjusting (reducing) the measured power by a bandwidth correction factor (BWCF) where $BWCF = 10\log(500 \text{ kHz}/300\text{kHz})$
- 5) Sweep time = auto, trigger set to "free run".
- 6) Trace average at least 100 traces in power averaging mode.
- 7) Record the max value and add $10 \log (1/\text{duty cycle})$

4.5.5 Deviation from Test Standard

No deviation.

4.5.6 EUT Operating Conditions

Same as item 4.3.6.

4.5.7 Test Results

For U-NII-2A, U-NII-2C band
802.11a

Chan.	Freq. (MHz)	PSD W/O Duty Factor (dBm/MHz)				Duty Factor (dB)	Total PSD With Duty Factor (dBm/MHz)	Max. Limit (dBm/MHz)	Pass / Fail
		Chain 0	Chain 1	Chain 2	Chain 3				
52	5260	1.98	2.08	1.02	1.42	0.18	7.85	8.88	Pass
60	5300	2.33	2.18	0.91	1.67	0.18	8.01	8.88	Pass
64	5320	2.14	1.89	0.77	1.63	0.18	7.84	8.88	Pass
100	5500	2.43	2.58	1.72	2.09	0.18	8.42	8.88	Pass
116	5580	2.53	2.37	1.06	1.66	0.18	8.14	8.88	Pass
140	5700	1.64	2.13	0.34	1.87	0.18	7.75	8.88	Pass
144	5720 For 5500~5720MHz	2.15	2.88	0.86	2.33	0.18	8.32	8.88	Pass

Note:

- Method E) 2) a) of power density measurement of KDB 662911 is using for calculating total power density. Total power density is summing entire spectra across corresponding frequency bins on the various outputs by computer.
- 5260~5320MHz Directional Gain = $2.1\text{dBi} + 10\log(4) = 8.12\text{dBi} > 6\text{dBi}$, so the limit shall be reduced to $11 - (8.12 - 6) = 8.88\text{dBm}$.
5500~5720MHz Directional Gain = $2.1\text{dBi} + 10\log(4) = 8.12\text{dBi} > 6\text{dBi}$, so the limit shall be reduced to $11 - (8.12 - 6) = 8.88\text{dBm}$.
- Refer to section 3.3 for duty cycle spectrum plot.

802.11n (HT20)

Chan.	Freq. (MHz)	PSD (dBm/MHz)				Total PSD (dBm/MHz)	Max. Limit (dBm/MHz)	Pass / Fail
		Chain 0	Chain 1	Chain 2	Chain 3			
52	5260	1.91	2.29	1.19	1.73	7.82	8.88	Pass
60	5300	2.38	2.38	1.11	2.03	8.03	8.88	Pass
64	5320	2.38	2.47	1.19	2.09	8.08	8.88	Pass
100	5500	2.28	2.45	1.63	2.07	8.14	8.88	Pass
116	5580	2.18	2.51	1.03	1.82	7.94	8.88	Pass
140	5700	2.13	2.74	1.27	2.48	8.21	8.88	Pass
144	5720 For 5500~5720MHz	2.19	2.82	1.23	2.45	8.23	8.88	Pass

Note:

- Method E) 2) a) of power density measurement of KDB 662911 is using for calculating total power density. Total power density is summing entire spectra across corresponding frequency bins on the various outputs by computer.
- 5260~5320MHz Directional Gain = $2.1\text{dBi} + 10\log(4) = 8.12\text{dBi} > 6\text{dBi}$, so the limit shall be reduced to $11 - (8.12 - 6) = 8.88\text{dBm}$.
5500~5720MHz Directional Gain = $2.1\text{dBi} + 10\log(4) = 8.12\text{dBi} > 6\text{dBi}$, so the limit shall be reduced to $11 - (8.12 - 6) = 8.88\text{dBm}$.

802.11n (HT40)

Chan.	Freq. (MHz)	PSD W/O Duty Factor (dBm/MHz)				Duty Factor (dB)	Total PSD With Duty Factor (dBm/MHz)	Max. Limit (dBm/MHz)	Pass / Fail
		Chain 0	Chain 1	Chain 2	Chain 3				
54	5270	0.60	2.01	0.95	0.83	0.14	7.29	8.88	Pass
62	5310	1.65	1.70	0.75	1.41	0.14	7.55	8.88	Pass
102	5510	1.69	1.88	1.50	1.33	0.14	7.77	8.88	Pass
110	5550	1.76	2.24	1.32	1.11	0.14	7.79	8.88	Pass
134	5670	1.43	1.80	1.01	1.74	0.14	7.67	8.88	Pass
142	5710 For 5500~5720MHz	1.56	2.37	1.02	1.77	0.14	7.87	8.88	Pass

Note:

- Method E) 2) a) of power density measurement of KDB 662911 is using for calculating total power density. Total power density is summing entire spectra across corresponding frequency bins on the various outputs by computer.
- 5260~5320MHz Directional Gain = $2.1\text{dBi} + 10\log(4) = 8.12\text{dBi} > 6\text{dBi}$, so the limit shall be reduced to $11 - (8.12 - 6) = 8.88\text{dBm}$.
5500~5720MHz Directional Gain = $2.1\text{dBi} + 10\log(4) = 8.12\text{dBi} > 6\text{dBi}$, so the limit shall be reduced to $11 - (8.12 - 6) = 8.88\text{dBm}$.
- Refer to section 3.3 for duty cycle spectrum plot.

802.11ac (VHT80)

Chan.	Freq. (MHz)	PSD W/O Duty Factor (dBm/MHz)				Duty Factor (dB)	Total PSD With Duty Factor (dBm/MHz)	Max. Limit (dBm/MHz)	Pass / Fail
		Chain 0	Chain 1	Chain 2	Chain 3				
58	5290	-1.97	-1.85	-2.03	-2.07	0.28	4.32	8.88	Pass
106	5530	-2.24	-1.72	-2.38	-2.45	0.28	4.11	8.88	Pass
122	5610	-1.76	-1.34	-1.58	-1.58	0.28	4.74	8.88	Pass
138	5690 For 5500~5720MHz	-1.76	-1.01	-2.17	-1.39	0.28	4.74	8.88	Pass

Note:

- Method E) 2) a) of power density measurement of KDB 662911 is using for calculating total power density. Total power density is summing entire spectra across corresponding frequency bins on the various outputs by computer.
- 5260~5320MHz Directional Gain = $2.1\text{dBi} + 10\log(4) = 8.12\text{dBi} > 6\text{dBi}$, so the limit shall be reduced to $11 - (8.12 - 6) = 8.88\text{dBm}$.
5500~5720MHz Directional Gain = $2.1\text{dBi} + 10\log(4) = 8.12\text{dBi} > 6\text{dBi}$, so the limit shall be reduced to $11 - (8.12 - 6) = 8.88\text{dBm}$.
- Refer to section 3.3 for duty cycle spectrum plot.

Spectrum Plot of Worst Value

802.11a / Chain 1 / CH 144

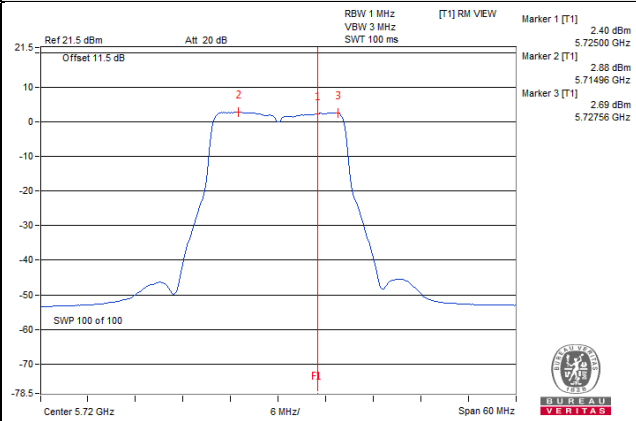

802.11n (HT20) / Chain 1 / CH 144

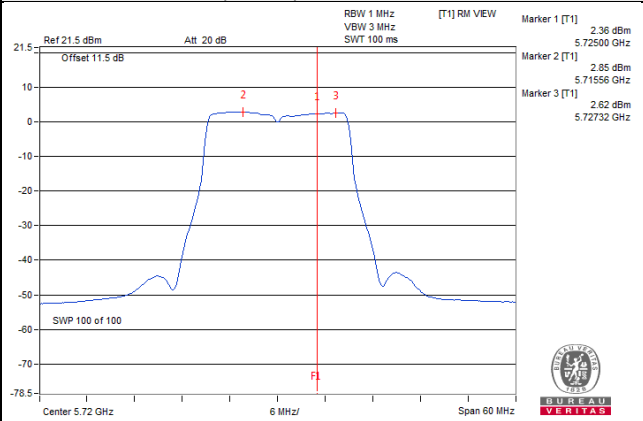

802.11n (HT40) / Chain 1 / CH 142

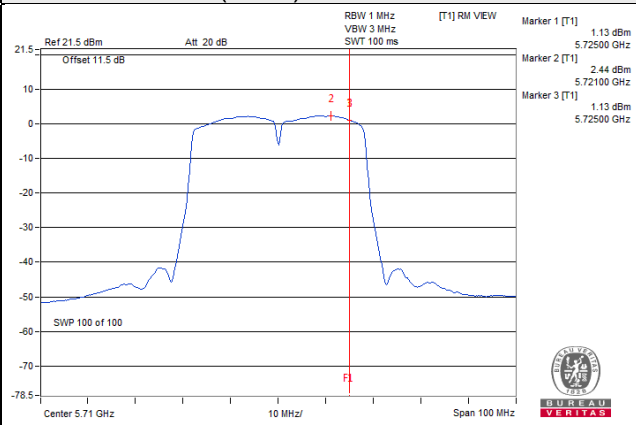

802.11ac (VHT80) / Chain 1 / CH 138

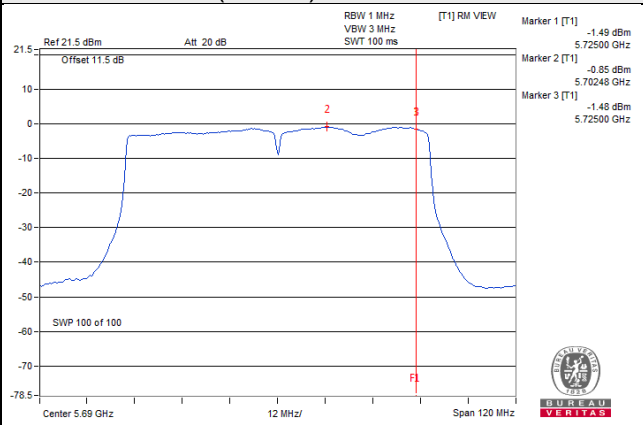

For U-NII-3 band

802.11a

TX chain	Chan.	Freq. (MHz)	PSD W/O Duty Factor		10 log (N=4) dB	Duty Factor (dB)	Total PSD With Duty Factor (dBm/500kHz)	Limit (dBm/500kHz)	Pass / Fail
			(dBm/300kHz)	(dBm/500kHz)					
0	144	5720 (For U-NII-3)	-6.02	-3.80	6.02	0.18	2.40	27.88	Pass
1	144	5720 (For U-NII-3)	-5.67	-3.45	6.02	0.18	2.75	27.88	Pass
2	144	5720 (For U-NII-3)	-7.38	-5.16	6.02	0.18	1.04	27.88	Pass
3	144	5720 (For U-NII-3)	-6.21	-3.99	6.02	0.18	2.21	27.88	Pass

Note:

1. Method E) 2) c) of power density measurement of KDB 662911 is using for calculating total power density.
2. Directional gain = 2.1dBi + 10log(4) = 8.12dBi > 6dBi, so the power density limit shall be reduced to 30-(8.12-6) = 27.88dBm.
3. Refer to section 3.3 for duty cycle spectrum plot.

802.11n (HT20)

TX chain	Chan.	Freq. (MHz)	PSD		10 log (N=4) dB	Total PSD With Duty Factor (dBm/500kHz)	Limit (dBm/500kHz)	Pass / Fail
			(dBm/300kHz)	(dBm/500kHz)				
0	144	5720 (For U-NII-3)	-6.11	-3.89	6.02	2.13	27.88	Pass
1	144	5720 (For U-NII-3)	-5.36	-3.14	6.02	2.88	27.88	Pass
2	144	5720 (For U-NII-3)	-6.97	-4.75	6.02	1.27	27.88	Pass
3	144	5720 (For U-NII-3)	-5.93	-3.71	6.02	2.31	27.88	Pass

Note:

1. Method E) 2) c) of power density measurement of KDB 662911 is using for calculating total power density.
2. Directional gain = 2.1dBi + 10log(4) = 8.12dBi > 6dBi, so the power density limit shall be reduced to 30-(8.12-6) = 27.88dBm.

802.11n (HT40)

TX chain	Chan.	Freq. (MHz)	PSD W/O Duty Factor		10 log (N=4) dB	Duty Factor (dB)	Total PSD With Duty Factor (dBm/500kHz)	Limit (dBm/500kHz)	Pass / Fail
			(dBm/300kHz)	(dBm/500kHz)					
0	142	5710 (For U-NII-3)	-8.49	-6.27	6.02	0.14	-0.11	27.88	Pass
1	142	5710 (For U-NII-3)	-7.76	-5.54	6.02	0.14	0.62	27.88	Pass
2	142	5710 (For U-NII-3)	-8.83	-6.61	6.02	0.14	-0.45	27.88	Pass
3	142	5710 (For U-NII-3)	-8.71	-6.49	6.02	0.14	-0.33	27.88	Pass

Note:

1. Method E) 2) c) of power density measurement of KDB 662911 is using for calculating total power density.
2. Directional gain = 2.1dBi + 10log(4) = 8.12dBi > 6dBi, so the power density limit shall be reduced to 30-(8.12-6) = 27.88dBm.
3. Refer to section 3.3 for duty cycle spectrum plot.

802.11ac (VHT80)

TX chain	Chan.	Freq. (MHz)	PSD W/O Duty Factor		10 log (N=4) dB	Duty Factor (dB)	Total PSD With Duty Factor (dBm/500kHz)	Limit (dBm/500kHz)	Pass / Fail
			(dBm/300kHz)	(dBm/500kHz)					
0	138	5690 (For U-NII-3)	-11.28	-9.06	6.02	0.28	-2.76	27.88	Pass
1	138	5690 (For U-NII-3)	-10.46	-8.24	6.02	0.28	-1.94	27.88	Pass
2	138	5690 (For U-NII-3)	-11.24	-9.02	6.02	0.28	-2.72	27.88	Pass
3	138	5690 (For U-NII-3)	-11.05	-8.83	6.02	0.28	-2.53	27.88	Pass

Note:

1. Method E) 2) c) of power density measurement of KDB 662911 is using for calculating total power density.
2. Directional gain = 2.1dBi + 10log(4) = 8.12dBi > 6dBi, so the power density limit shall be reduced to 30-(8.12-6) = 27.88dBm.
3. Refer to section 3.3 for duty cycle spectrum plot.

Spectrum Plot of Worst Value

802.11a

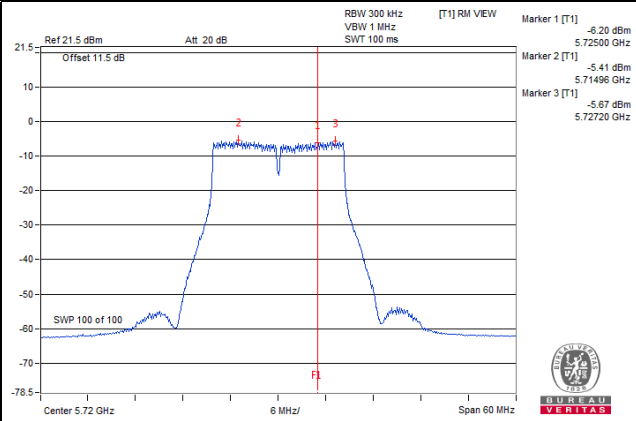

802.11n (HT20)

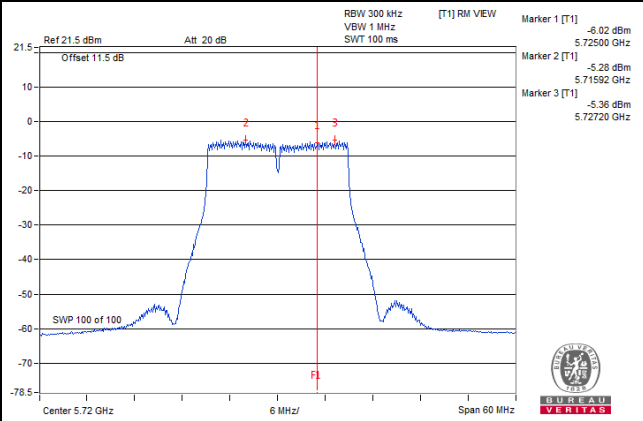

802.11n (HT40)

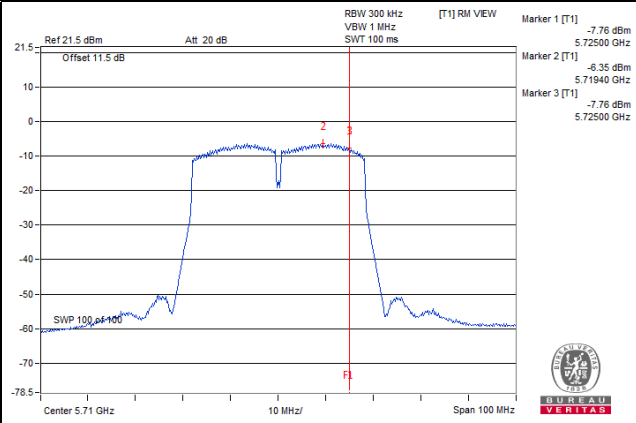

802.11ac (VHT80)

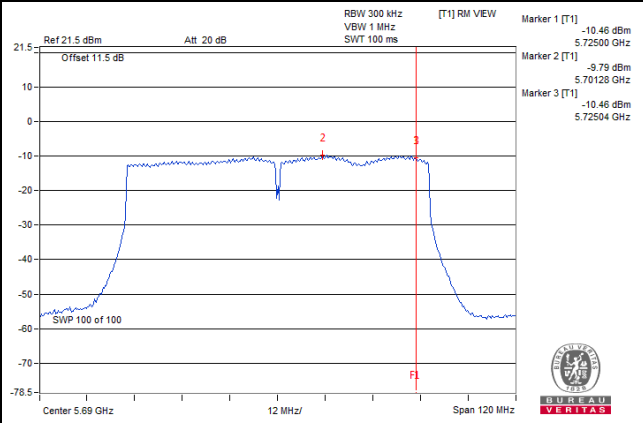

4.6 Frequency Stability

4.6.1 Limits of Frequency Stability Measurement

The frequency of the carrier signal shall be maintained within band of operation

4.6.2 Test Setup

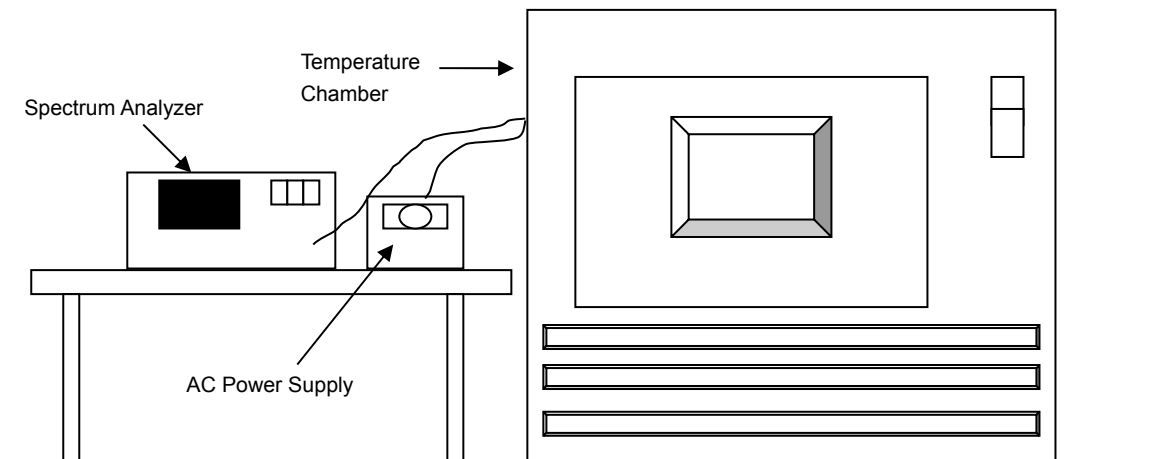

4.6.3 Test Instruments

Description & Manufacturer	Model No.	Serial No.	Cal. Date	Cal. Due
Spectrum Analyzer ROHDE & SCHWARZ	FSP40	100039	Jun. 11, 2018	Jun. 10, 2019
WIT Standard Temperature And Humidity Chamber	TH-4S-C	W981030	Jun. 04, 2018	Jun. 03, 2019
Digital Multimeter Fluke	87-III	70360742	Jun. 29, 2018	Jun. 28, 2019
AC Power Supply Exttech	CFW-105	E000603	NA	NA

4.6.4 Test Procedure

- The EUT was placed inside the environmental test chamber and powered by nominal AC voltage.
- Turn the EUT on and couple its output to a spectrum analyzer.
- Turn the EUT off and set the chamber to the highest temperature specified.
- Allow sufficient time (approximately 30 min) for the temperature of the chamber to stabilize, turn the EUT on and measure the operating frequency after 2, 5, and 10 minutes.
- Repeat step c and d with every 10 degrees reduction until the lowest temperature achieved.
- The test chamber was allowed to stabilize at +20 degree C for a minimum of 30 minutes. The supply voltage was then adjusted on the EUT from 85% to 115% and the frequency record.

4.6.5 Deviation from Test Standard

No deviation.

4.6.6 EUT Operating Condition

Set the EUT transmit at un-modulation mode to test frequency stability.

4.6.7 Test Results

Frequency Stability Versus Temp.									
Operating Frequency: 5260MHz									
Temp. (°C)	Power Supply (Vac)	0 Minute		2 Minute		5 Minute		10 Minute	
		Measured Frequency (MHz)	Result	Measured Frequency (MHz)	Result	Measured Frequency (MHz)	Result	Measured Frequency (MHz)	Result
50	120	5260.002	Pass	5260.0035	Pass	5260.0027	Pass	5260.0025	Pass
40	120	5259.9747	Pass	5259.9725	Pass	5259.972	Pass	5259.9732	Pass
30	120	5259.9741	Pass	5259.9789	Pass	5259.9757	Pass	5259.9785	Pass
20	120	5260.0022	Pass	5260.003	Pass	5259.9996	Pass	5259.9992	Pass
10	120	5259.984	Pass	5259.9825	Pass	5259.9832	Pass	5259.9805	Pass
0	120	5260.0215	Pass	5260.0204	Pass	5260.0189	Pass	5260.0218	Pass

Frequency Stability Versus Voltage									
Operating Frequency: 5260MHz									
Temp. (°C)	Power Supply (Vac)	0 Minute		2 Minute		5 Minute		10 Minute	
		Measured Frequency (MHz)	Result	Measured Frequency (MHz)	Result	Measured Frequency (MHz)	Result	Measured Frequency (MHz)	Result
20	138	5260.0032	Pass	5260.0021	Pass	5260.0006	Pass	5259.999	Pass
	120	5260.0022	Pass	5260.003	Pass	5259.9996	Pass	5259.9992	Pass
	102	5260.0022	Pass	5260.0038	Pass	5260.0000	Pass	5259.9998	Pass

4.7 6dB Bandwidth Measurement

4.7.1 Limits of 6dB Bandwidth Measurement

The minimum of 6dB Bandwidth Measurement is 0.5MHz.

4.7.2 Test Setup

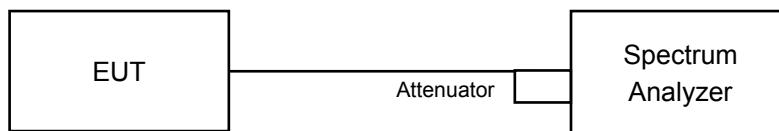

4.7.3 Test Instruments

Refer to section 4.1.2 to get information of above instrument.

4.7.4 Test Procedure

Measurement Procedure REF

- Set resolution bandwidth (RBW) = 100kHz
- Set the video bandwidth (VBW) $\geq 3 \times$ RBW, Detector = Peak.
- Trace mode = max hold.
- Sweep = auto couple.
- Measure the maximum width of the emission that is constrained by the frequencies associated with the two amplitude points (upper and lower) that are attenuated by 6 dB relative to the maximum level measured in the fundamental emission

4.7.5 Deviation from Test Standard

No deviation.

4.7.6 EUT Operating Condition

The software provided by client to enable the EUT under transmission condition continuously at lowest, middle and highest channel frequencies individually.

4.7.7 Test Results

802.11a

Channel	Frequency (MHz)	6dB Bandwidth (MHz)				Minimum Limit (MHz)	Pass / Fail
		Chain 0	Chain 1	Chain 2	Chain 3		
144	5720 For 5745~5825MHz	16.35	16.43	16.35	16.42	0.5	Pass

802.11n (HT20)

Channel	Frequency (MHz)	6dB Bandwidth (MHz)				Minimum Limit (MHz)	Pass / Fail
		Chain 0	Chain 1	Chain 2	Chain 3		
144	5720 For 5745~5825MHz	17.24	17.63	16.59	17.62	0.5	Pass

802.11n (HT40)

Channel	Frequency (MHz)	6dB Bandwidth (MHz)				Minimum Limit (MHz)	Pass / Fail
		Chain 0	Chain 1	Chain 2	Chain 3		
142	5710 For 5745~5825MHz	35.18	35.12	35.31	35.10	0.5	Pass

802.11ac (VHT80)

Channel	Frequency (MHz)	6dB Bandwidth (MHz)				Minimum Limit (MHz)	Pass / Fail
		Chain 0	Chain 1	Chain 2	Chain 3		
138	5690 For 5745~5825MHz	76.46	75.87	76.47	75.53	0.5	Pass

Spectrum Plot of Worst Value

802.11a

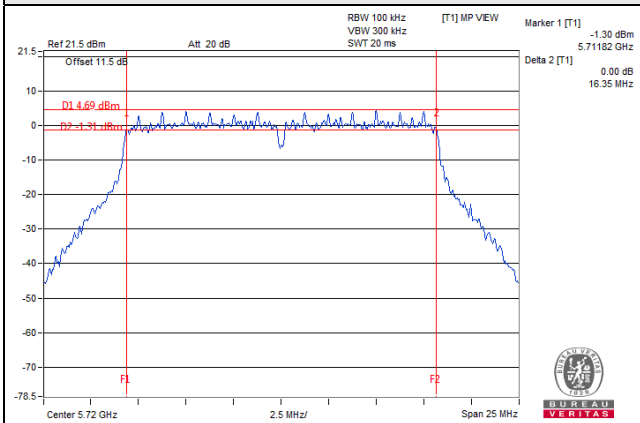

802.11n (HT20)

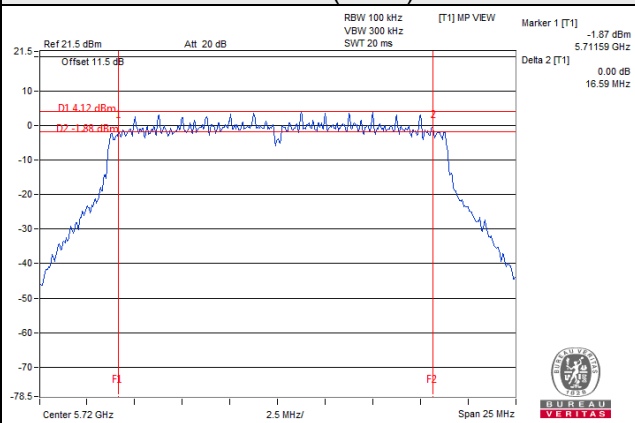

802.11n (HT40)

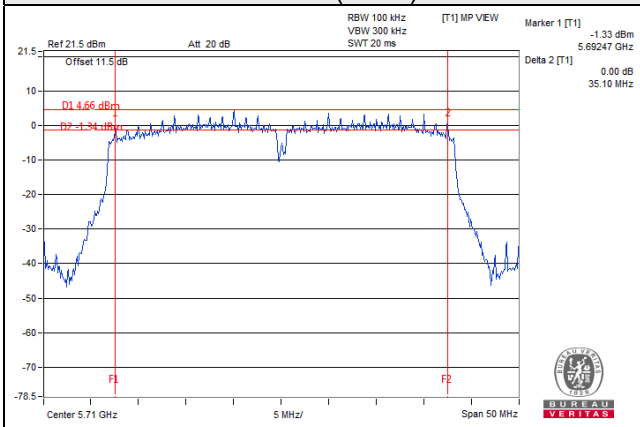

802.11ac (VHT80)

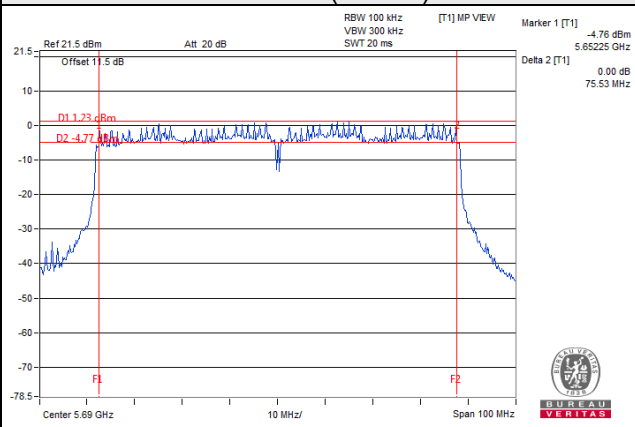

Note:

For CH144 (UNII-3 Band): The 6dB bandwidth above 5725MHz = Marker 1 + Delta 2 - 5725MHz

For CH142 (UNII-3 Band): The 6dB bandwidth above 5725MHz = Marker 1 + Delta 2 - 5725MHz

For CH138 (UNII-3 Band): The 6dB bandwidth above 5725MHz = Marker 1 + Delta 2 - 5725MHz

5 Pictures of Test Arrangements

Please refer to the attached file (Test Setup Photo).

Appendix – Information of the Testing Laboratories

We, Bureau Veritas Consumer Products Services (H.K.) Ltd., Taoyuan Branch, were founded in 1988 to provide our best service in EMC, Radio, Telecom and Safety consultation. Our laboratories are FCC recognized accredited test firms and accredited and approved according to ISO/IEC 17025.

If you have any comments, please feel free to contact us at the following:

Lin Kou EMC/RF Lab

Tel: 886-2-26052180

Fax: 886-2-26051924

Hsin Chu EMC/RF/Telecom Lab

Tel: 886-3-6668565

Fax: 886-3-6668323

Hwa Ya EMC/RF/Safety

Tel: 886-3-3183232

Fax: 886-3-3270892

Email: service.adt@tw.bureauveritas.com

Web Site: www.bureauveritas-adt.com

The address and road map of all our labs can be found in our web site also.

--- END ---