

## FCC Test Report

**Report No.:** RF181115C24-4

**FCC ID:** 2ARXKVHE09

**Test Model:** VHE09

**Series Model:** VHE09XXX (X=A-Z, 0-9, blank or "-")

**Received Date:** Nov. 15, 2018

**Test Date:** Mar. 29 ~ Apr. 23, 2019

**Issued Date:** May 24, 2019

**Applicant:** Veea Inc

**Address:** 164 E 83rd Street, New York NY, 10028, USA

**Issued By:** Bureau Veritas Consumer Products Services (H.K.) Ltd., Taoyuan Branch

**Lab Address:** No. 47-2, 14th Ling, Chia Pau Vil., Lin Kou Dist., New Taipei City, Taiwan, R.O.C.

**Test Location:** No. 19, Hwa Ya 2nd Rd., Wen Hwa Vil., Kwei Shan Dist., Taoyuan City 33383, TAIWAN (R.O.C.)

**FCC Registration /  
Designation Number:** 788550 / TW0003



This report is for your exclusive use. Any copying or replication of this report to or for any other person or entity, or use of our name or trademark, is permitted only with our prior written permission. This report sets forth our findings solely with respect to the test samples identified herein. The results set forth in this report are not indicative or representative of the quality or characteristics of the lot from which a test sample was taken or any similar or identical product unless specifically and expressly noted. Our report includes all of the tests requested by you and the results thereof based upon the information that you provided to us. You have 60 days from date of issuance of this report to notify us of any material error or omission caused by our negligence, provided, however, that such notice shall be in writing and shall specifically address the issue you wish to raise. A failure to raise such issue within the prescribed time shall constitute your unqualified acceptance of the completeness of this report, the tests conducted and the correctness of the report contents. Unless specific mention, the uncertainty of measurement has been explicitly taken into account to declare the compliance or non-compliance to the specification. The report must not be used by the client to claim product certification, approval, or endorsement by TAF or any government agencies.

## Table of Contents

<b>Release Control Record</b> .....	<b>4</b>
<b>1 Certificate of Conformity</b> .....	<b>5</b>
<b>2 Summary of Test Results</b> .....	<b>6</b>
2.1 Measurement Uncertainty .....	6
2.2 Modification Record .....	6
<b>3 General Information</b> .....	<b>7</b>
3.1 General Description of EUT .....	7
3.2 Description of Test Modes .....	9
3.2.1 Test Mode Applicability and Tested Channel Detail .....	10
3.3 Duty Cycle of Test Signal .....	12
3.4 Description of Support Units .....	13
3.4.1 Configuration of System under Test .....	13
3.5 General Description of Applied Standards .....	14
<b>4 Test Types and Results</b> .....	<b>15</b>
4.1 Radiated Emission and Bandedge Measurement.....	15
4.1.1 Limits of Radiated Emission and Bandedge Measurement .....	15
4.1.2 Test Instruments .....	16
4.1.3 Test Procedures.....	17
4.1.4 Deviation from Test Standard .....	18
4.1.5 Test Set Up .....	18
4.1.6 EUT Operating Conditions.....	19
4.1.7 Test Results .....	20
4.2 Conducted Emission Measurement .....	44
4.2.1 Limits of Conducted Emission Measurement .....	44
4.2.2 Test Instruments .....	44
4.2.3 Test Procedures.....	45
4.2.4 Deviation from Test Standard .....	45
4.2.5 Test Setup.....	45
4.2.6 EUT Operating Conditions.....	45
4.2.7 Test Results .....	46
4.3 Transmit Power Measurement .....	50
4.3.1 Limits of Transmit Power Measurement .....	50
4.3.2 Test Setup.....	50
4.3.3 Test Instruments .....	51
4.3.4 Test Procedure .....	51
4.3.5 Deviation from Test Standard .....	51
4.3.6 EUT Operating Conditions.....	51
4.3.7 Test Result.....	52
4.4 Occupied Bandwidth Measurement .....	57
4.4.1 Test Setup.....	57
4.4.2 Test Instruments .....	57
4.4.3 Test Procedure .....	57
4.4.4 Test Result.....	58
4.5 Peak Power Spectral Density Measurement .....	60
4.5.1 Limits of Peak Power Spectral Density Measurement .....	60
4.5.2 Test Setup.....	60
4.5.3 Test Instruments .....	60
4.5.4 Test Procedures.....	61
4.5.5 Deviation from Test Standard .....	61
4.5.6 EUT Operating Conditions.....	61
4.5.7 Test Results .....	62
4.6 Frequency Stability.....	69
4.6.1 Limits of Frequency Stability Measurement .....	69

4.6.2	Test Setup.....	69
4.6.3	Test Instruments .....	69
4.6.4	Test Procedure .....	69
4.6.5	Deviation from Test Standard .....	70
4.6.6	EUT Operating Condition .....	70
4.6.7	Test Results .....	70
4.7	6dB Bandwidth Measurement.....	71
4.7.1	Limits of 6dB Bandwidth Measurement.....	71
4.7.2	Test Setup.....	71
4.7.3	Test Instruments .....	71
4.7.4	Test Procedure .....	71
4.7.5	Deviation from Test Standard .....	71
4.7.6	EUT Operating Condition .....	71
4.7.7	Test Results .....	72
<b>5</b>	<b>Pictures of Test Arrangements.....</b>	<b>74</b>
	<b>Annex A- Radiated Out of Band Emission (OOBE) Measurement (For U-NII-3 band).....</b>	<b>75</b>
	<b>Appendix – Information of the Testing Laboratories .....</b>	<b>78</b>

### Release Control Record

Issue No.	Description	Date Issued
RF181115C24-4	Original release.	May 24, 2019

## 1 Certificate of Conformity

**Product:** veeaHub

**Brand:** 

**Test Model:** VHE09

**Series Model:** VHE09XXX (X=A-Z, 0-9, blank or "-")

**Sample Status:** Engineering sample

**Applicant:** Veea Inc

**Test Date:** Mar. 29 ~ Apr. 23, 2019

**Standards:** 47 CFR FCC Part 15, Subpart E (Section 15.407)  
ANSI C63.10:2013

The above equipment has been tested by **Bureau Veritas Consumer Products Services (H.K.) Ltd., Taoyuan Branch**, and found compliance with the requirement of the above standards. The test record, data evaluation & Equipment Under Test (EUT) configurations represented herein are true and accurate accounts of the measurements of the sample's RF characteristics under the conditions specified in this report.

**Prepared by :** , **Date:** May 24, 2019  
Pettie Chen / Senior Specialist

**Approved by :** , **Date:** May 24, 2019  
Bruce Chen / Project Engineer

## 2 Summary of Test Results

47 CFR FCC Part 15, Subpart E (Section 15.407)			
FCC Clause	Test Item	Result	Remarks
15.407(b)(6)	AC Power Conducted Emissions	Pass	Meet the requirement of limit. Minimum passing margin is -2.95dB at 0.50600MHz.
15.407(b)(1/2/3/4(i/ii)/6)	Radiated Emissions & Band Edge Measurement	Pass	Meet the requirement of limit. Minimum passing margin is -1.0dB at 5925.00MHz.
15.407(a)(1/2/3)	Max Average Transmit Power	Pass	Meet the requirement of limit.
---	Occupied Bandwidth Measurement	Pass	Meet the requirement of limit.
15.407(a)(1/2/3)	Peak Power Spectral Density	Pass	Meet the requirement of limit.
15.407(e)	6dB bandwidth	Pass	Meet the requirement of limit. (U-NII-3 Band only)
15.407(g)	Frequency Stability	Pass	Meet the requirement of limit.
15.203	Antenna Requirement	Pass	No antenna connector is used.

\*For U-NII-3 band compliance with rule part 15.407(b)(4)(i), the OOB test plots were recorded in Annex A.  
 Note: Determining compliance based on the results of the compliance measurement, not taking into account measurement instrumentation uncertainty.

### 2.1 Measurement Uncertainty

Where relevant, the following measurement uncertainty levels have been estimated for tests performed on the EUT as specified in CISPR 16-4-2:

Measurement	Frequency	Expanded Uncertainty (k=2) ( $\pm$ )
Conducted Emissions at mains ports	150kHz ~ 30MHz	2.94 dB
Radiated Emissions up to 1 GHz	9kHz ~ 30MHz	3.04 dB
	30MHz ~ 200MHz	3.86 dB
	200MHz ~ 1000MHz	3.87 dB
Radiated Emissions above 1 GHz	1GHz ~ 18GHz	2.29 dB
	18GHz ~ 40GHz	2.29 dB

### 2.2 Modification Record

There were no modifications required for compliance.

### 3 General Information

#### 3.1 General Description of EUT

Product	veeaHub
Brand	
Test Model	VHE09
Series Model	VHE09XXX (X=A-Z, 0-9, blank or "-")
Model Difference	Marketing purposes
Sample Status	Engineering sample
Power Supply Rating	48Vdc (Adapter and PoE)
Modulation Type	256QAM, 64QAM, 16QAM, QPSK, BPSK
Modulation Technology	OFDM
Transfer Rate	802.11a: 54/48/36/24/18/12/9/6Mbps 802.11n: up to 600Mbps 802.11ac: up to 3466.7Mbps
Operating Frequency	5180~5240MHz, 5745~5825MHz
Number of Channel	5180 ~ 5240MHz: 4 for 802.11a, 802.11n (HT20), 802.11ac (VHT20) 2 for 802.11n (HT40), 802.11ac (VHT40) 1 for 802.11ac (VHT80), 802.11ac (VHT80+VHT80) 5745 ~ 5825MHz: 5 for 802.11a, 802.11n (HT20), 802.11ac (VHT20) 2 for 802.11n (HT40), 802.11ac (VHT40) 1 for 802.11ac (VHT80), 802.11ac (VHT80+VHT80)
Output Power	CDD Mode: 5180~5240MHz: 826.253mW 5745~5825MHz: 997.944mW Beamforming Mode: 5180~5240MHz: 206.592mW 5745~5825MHz: 224.062mW
Antenna Type	Chip antenna with 2.1dBi gain
Antenna Connector	NA
Accessory Device	Adapter
Cable Supplied	NA

Note:

1. The EUT incorporates a MIMO function. Physically, the EUT provides 4 completed transmitter and 4 receivers.

Band	Modulation Mode	CDD Mode	Beamforming Mode	TX Function
5GHz	802.11a	Support	Not Support	4TX
	802.11n (HT20)	Support	Support	4TX
	802.11n (HT40)	Support	Support	4TX
	802.11ac (VHT80)	Support	Support	4TX
	802.11ac (VHT80+VHT80)	Support	Support	2TX+2TX

\* The modulation and bandwidth are similar for 802.11n mode for HT20/HT40 and 802.11ac mode for VHT20/VHT40. After pre-testing, 802.11ac (VHT20/VHT40) power is lower than 802.11n (HT20/HT40), therefore 802.11n (HT20/HT40) is the worst case to representative mode in test report. (Final test mode refer section 3.2.1)

2. The EUT uses following adapter and PoE.

Adapter	
Brand	EDAC Power Electronics Co., Ltd.
Model	EA1062SGR-480
Input Power	100-240Vac ~2.5A, 50-60Hz
Output Power	48Vdc / 1.35A
Power Line	1.2m DC cable with one core

PoE (Support unit)	
Model	APOE02-WM
Output Power	48Vdc

3. WLAN, zigbee and Bluetooth technology can transmit at same time.



### 3.2 Description of Test Modes

#### 5180 ~ 5240MHz:

4 channels are provided for 802.11a, 802.11n (HT20), 802.11ac (VHT20):

Channel	Frequency	Channel	Frequency
36	5180 MHz	44	5220 MHz
40	5200 MHz	48	5240 MHz

2 channels are provided for 802.11n (HT40), 802.11ac (VHT40):

Channel	Frequency	Channel	Frequency
38	5190 MHz	46	5230 MHz

1 channel is provided for 802.11ac (VHT80), 802.11ac (VHT80+VHT80):

Channel	Frequency
42	5210MHz

#### 5745 ~ 5825MHz:

5 channels are provided for 802.11a, 802.11n (HT20), 802.11ac (VHT20):

Channel	Frequency	Channel	Frequency
149	5745MHz	161	5805MHz
153	5765MHz	165	5825MHz
157	5785MHz		

2 channels are provided for 802.11n (HT40), 802.11ac (VHT40):

Channel	Frequency	Channel	Frequency
151	5755MHz	159	5795MHz

1 channel is provided for 802.11ac (VHT80), 802.11ac (VHT80+VHT80):

Channel	Frequency
155	5775MHz

### 3.2.1 Test Mode Applicability and Tested Channel Detail

EUT CONFIGURE MODE	APPLICABLE TO				DESCRIPTION
	RE $\geq$ 1G	RE $<$ 1G	PLC	APCM	
A	√	√	√	√	Power from adapter
B	-	√	√	-	Power from PoE

Where **RE $\geq$ 1G**: Radiated Emission above 1GHz & Bandedge Measurement  
**RE $<$ 1G**: Radiated Emission below 1GHz  
**PLC**: Power Line Conducted Emission  
**APCM**: Antenna Port Conducted Measurement

**Note:**

- The EUT had been pre-tested on the positioned of each 3 axis. The worst case was found when positioned on Y-plane.

#### Radiated Emission Test (Above 1GHz):

- Pre-Scan has been conducted to determine the worst-case mode from all possible combinations between available modulations, data rates and antenna ports (if EUT with antenna diversity architecture).
- Following channel(s) was (were) selected for the final test as listed below.

EUT Configure Mode	Mode	Frequency Band (MHz)	Available Channel	Tested Channel	Modulation Technology	Data Rate (Mbps)
A	802.11a	5180-5240	36 to 48	36, 40, 48	OFDM	6.0
	802.11n (HT20)		36 to 48	36, 40, 48	OFDM	6.5
	802.11n (HT40)		38 to 46	38, 46	OFDM	13.5
	802.11ac (VHT80)		42	42	OFDM	29.3
A	802.11a	5745-5825	149 to 165	149, 157, 165	OFDM	6.0
	802.11n (HT20)		149 to 165	149, 157, 165	OFDM	6.5
	802.11n (HT40)		151 to 159	151, 159	OFDM	13.5
	802.11ac (VHT80)		155	155	OFDM	29.3
A	802.11ac (VHT80+VHT80)	5180-5240 5745-5825	42+155	42+155	OFDM	58.5

#### Radiated Emission Test (Below 1GHz):

- Pre-Scan has been conducted to determine the worst-case mode from all possible combinations between available modulations, data rates and antenna ports (if EUT with antenna diversity architecture).
- Following channel(s) was (were) selected for the final test as listed below.

EUT Configure Mode	Mode	Frequency Band (MHz)	Available Channel	Tested Channel	Modulation Technology	Data Rate (Mbps)
A, B	802.11a	5180-5240	36 to 48	48	OFDM	6.0
		5745-5825	149 to 165		OFDM	6.0

#### Power Line Conducted Emission Test:

- Pre-Scan has been conducted to determine the worst-case mode from all possible combinations between available modulations, data rates and antenna ports (if EUT with antenna diversity architecture).
- Following channel(s) was (were) selected for the final test as listed below.

EUT Configure Mode	Mode	Frequency Band (MHz)	Available Channel	Tested Channel	Modulation Technology	Data Rate (Mbps)
A, B	802.11a	5180-5240	36 to 48	48	OFDM	6.0
		5745-5825	149 to 165		OFDM	6.0

Antenna Port Conducted Measurement:

- This item includes all test value of each mode, but only includes spectrum plot of worst value of each mode.
- Pre-Scan has been conducted to determine the worst-case mode from all possible combinations between available modulations, data rates and antenna ports (if EUT with antenna diversity architecture).
- Following channel(s) was (were) selected for the final test as listed below.

EUT Configure Mode	Mode	Frequency Band (MHz)	Available Channel	Tested Channel	Modulation Technology	Data Rate (Mbps)
A	802.11a	5180-5240	36 to 48	36, 40, 48	OFDM	6.0
	802.11n (HT20)		36 to 48	36, 40, 48	OFDM	6.5
	802.11n (HT40)		38 to 46	38, 46	OFDM	13.5
	802.11ac (VHT80)		42	42	OFDM	29.3
A	802.11a	5745-5825	149 to 165	149, 157, 165	OFDM	6.0
	802.11n (HT20)		149 to 165	149, 157, 165	OFDM	6.5
	802.11n (HT40)		151 to 159	151, 159	OFDM	13.5
	802.11ac (VHT80)		155	155	OFDM	29.3
A	802.11ac (VHT80+VHT80)	5180-5240 5745-5825	42+155	42+155	OFDM	58.5

Test Condition:

APPLICABLE TO	ENVIRONMENTAL CONDITIONS	INPUT POWER	TESTED BY
RE $\geq$ 1G	24 deg. C, 69% RH	120Vac, 60Hz	Willy Cheng Adair Peng
RE<1G	24 deg. C, 69% RH	120Vac, 60Hz 48Vdc	Adair Peng
PLC	22 deg. C, 66% RH	120Vac, 60Hz 48Vdc	Adair Peng
APCM	25 deg. C, 60% RH	120Vac, 60Hz	Alan Wu

### 3.3 Duty Cycle of Test Signal

Duty cycle of test signal is > 98%, duty factor is not required

Duty cycle of test signal is < 98 %, duty factor is required

**802.11a:** Duty cycle = 2.048/2.135 = 0.959, Duty factor =  $10 * \log(1/0.959) = 0.18$

**802.11n (HT20):** Duty cycle = 4.98/5.07 = 0.982

**802.11n (HT40):** Duty cycle = 2.423/2.503 = 0.968, Duty factor =  $10 * \log(1/0.968) = 0.14$

**802.11ac (VHT80), 802.11ac (VHT80+VHT80):**

Duty cycle = 1.143/1.22 = 0.937, Duty factor =  $10 * \log(1/0.937) = 0.28$

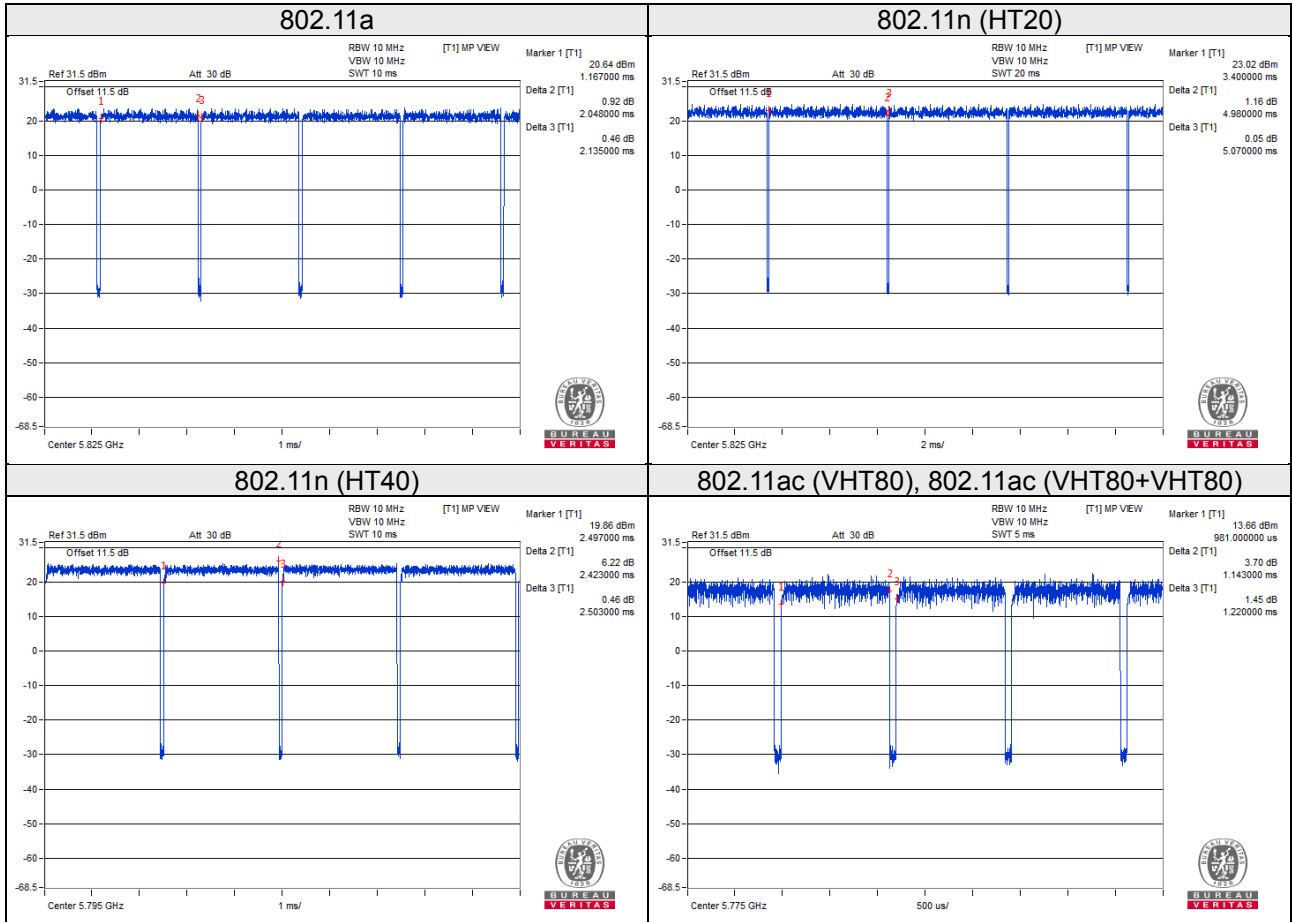

### 3.4 Description of Support Units

The EUT has been tested as an independent unit together with other necessary accessories or support units. The following support units or accessories were used to form a representative test configuration during the tests.

ID	Product	Brand	Model No.	Serial No.	FCC ID	Remarks
A.	Notebook	DELL	E5410	1HC2XM1	FCC DoC Approved	-
B.	Load	NA	NA	NA	NA	-
C.	USB Flash	HP	v250W	04	NA	-
D.	USB Flash	HP	v250W	05	NA	-
E.	USB Flash	HP	v250W	06	NA	-
F.	PoE	NA	APOE02-WM	NA	NA	Provided by manufacturer

Note:

1. All power cords of the above support units are non-shielded (1.8m).
2. Item A acted as a communication partner to transfer data.

ID	Descriptions	Qty.	Length (m)	Shielding (Yes/No)	Cores (Qty.)	Remarks
1.	RJ45 cable	1	1.5	N	0	Cat5e
2.	RJ45 cable	1	6	N	0	Cat5e
3.	Console cable	1	2	N	0	-
4.	RJ45 cable	1	1.5	N	0	Cat5e

#### 3.4.1 Configuration of System under Test

Test Mode A

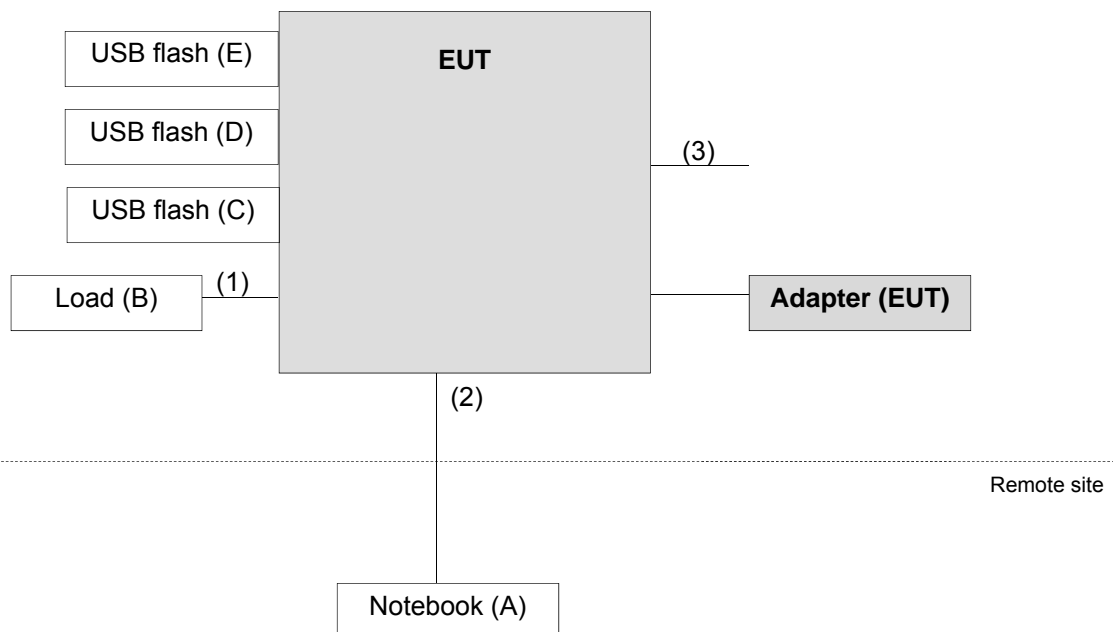

### Test Mode B

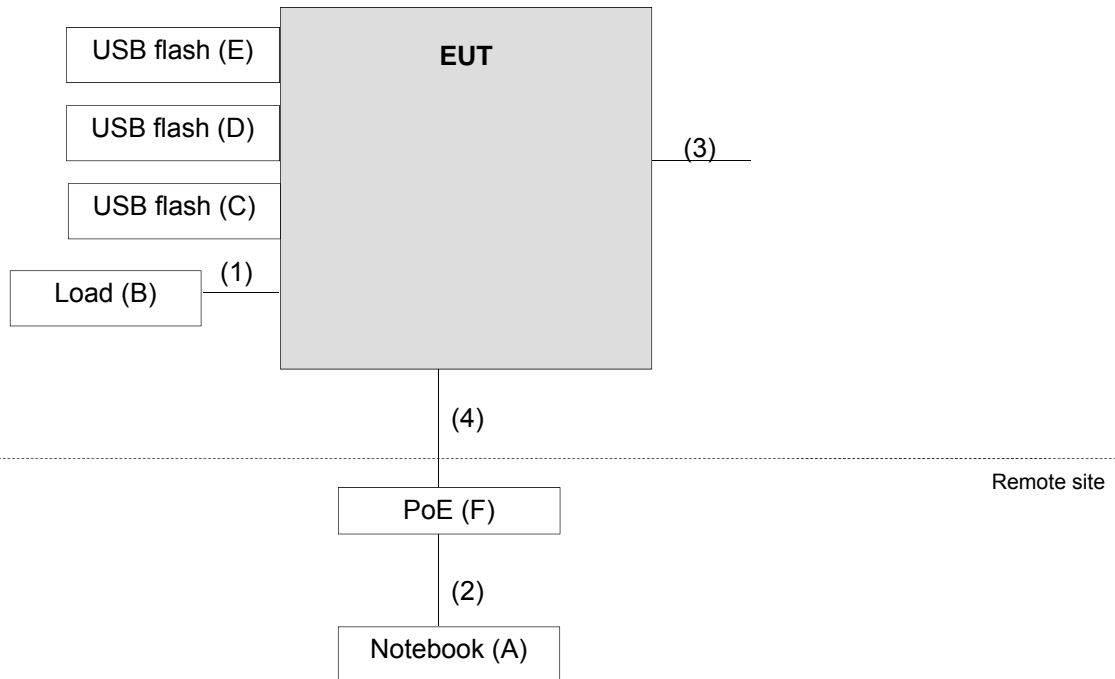

### 3.5 General Description of Applied Standards

The EUT is a RF Product. According to the specifications of the manufacturer, it must comply with the requirements of the following standards:

**FCC Part 15, Subpart E (15.407)**

**KDB 789033 D02 General UNII Test Procedure New Rules v02r01**

**KDB 662911 D01 Multiple Transmitter Output v02r01**

ANSI C63.10:2013

All test items have been performed and recorded as per the above standards.

## 4 Test Types and Results

### 4.1 Radiated Emission and Bandedge Measurement

#### 4.1.1 Limits of Radiated Emission and Bandedge Measurement

Radiated emissions which fall in the restricted bands must comply with the radiated emission limits specified as below table.

Frequencies (MHz)	Field Strength (microvolts/meter)	Measurement Distance (meters)
0.009 ~ 0.490	2400/F(kHz)	300
0.490 ~ 1.705	24000/F(kHz)	30
1.705 ~ 30.0	30	30
30 ~ 88	100	3
88 ~ 216	150	3
216 ~ 960	200	3
Above 960	500	3

#### NOTE:

- The lower limit shall apply at the transition frequencies.
- Emission level (dBuV/m) = 20 log Emission level (uV/m).
- For frequencies above 1000MHz, the field strength limits are based on average detector, however, the peak field strength of any emission shall not exceed the maximum permitted average limits, specified above by more than 20dB under any condition of modulation.

#### Limits of unwanted emission out of the restricted bands

Applicable To		Limit	
789033 D02 General UNII Test Procedure New Rules v02r01		Field Strength at 3m	
		PK: 74 (dBuV/m)	AV: 54 (dBuV/m)
Frequency Band	Applicable To	EIRP Limit	Equivalent Field Strength at 3m
5150~5250 MHz	15.407(b)(1)	PK: -27 (dBm/MHz)	PK: 68.2(dBuV/m)
5250~5350 MHz	15.407(b)(2)		
5470~5725 MHz	15.407(b)(3)		
5725~5850 MHz	<input checked="" type="checkbox"/> 15.407(b)(4)(i)	PK: -27 (dBm/MHz) <sup>*1</sup> PK: 10 (dBm/MHz) <sup>*2</sup> PK: 15.6 (dBm/MHz) <sup>*3</sup> PK: 27 (dBm/MHz) <sup>*4</sup>	PK: 68.2(dBuV/m) <sup>*1</sup> PK: 105.2 (dBuV/m) <sup>*2</sup> PK: 110.8(dBuV/m) <sup>*3</sup> PK: 122.2 (dBuV/m) <sup>*4</sup>
	<input type="checkbox"/> 15.407(b)(4)(ii)	Emission limits in section 15.247(d)	
<sup>*1</sup> beyond 75 MHz or more above of the band edge. <sup>*3</sup> below the band edge increasing linearly to a level of 15.6 dBm/MHz at 5 MHz above.		<sup>*2</sup> below the band edge increasing linearly to 10 dBm/MHz at 25 MHz above. <sup>*4</sup> from 5 MHz above or below the band edge increasing linearly to a level of 27 dBm/MHz at the band edge.	

**Note:** The following formula is used to convert the equipment isotropic radiated power (eirp) to field strength:

$$E = \frac{1000000 \sqrt{30P}}{3} \mu\text{V/m, where P is the eirp (Watts).}$$

#### 4.1.2 Test Instruments

Description & Manufacturer	Model No.	Serial No.	Cal. Date	Cal. Due
Test Receiver ROHDE & SCHWARZ	ESIB7	100187	May 29, 2018	May 28, 2019
Spectrum Analyzer ROHDE & SCHWARZ	FSP40	100040	Sep. 25, 2018	Sep. 24, 2019
BILOG Antenna SCHWARZBECK	VULB9168	9168-171	Nov. 22, 2018	Nov. 21, 2019
HORN Antenna SCHWARZBECK	9120D	209	Nov. 25, 2018	Nov. 24, 2019
HORN Antenna SCHWARZBECK	BBHA 9170	BBHA9170241	Nov. 25, 2018	Nov. 24, 2019
Loop Antenna TESEQ	HLA 6121	45745	Jun. 14, 2018	Jun. 13, 2019
Preamplifier Agilent (Below 1GHz)	8447D	2944A10738	Aug. 21, 2018	Aug. 20, 2019
Preamplifier Agilent (Above 1GHz)	8449B	3008A02465	Mar. 27, 2019	Mar. 26, 2020
RF signal cable HUBER+SUHNER	SUCOFLEX 104	Cable-CH3-03 (223653/4)	Aug. 21, 2018	Aug. 20, 2019
RF signal cable HUBER+SUHNER& EMCI	SUCOFLEX 104&EMC104-SM-SM- 8000	Cable-CH3-03 (309224+170907)	Aug. 21, 2018	Aug. 20, 2019
Software BV ADT	ADT_Radiated_ V7.6.15.9.5	NA	NA	NA
Antenna Tower inn-co GmbH	MA 4000	013303	NA	NA
Antenna Tower Controller BV ADT	AT100	AT93021702	NA	NA
Turn Table BV ADT	TT100	TT93021702	NA	NA
Turn Table Controller BV ADT	SC100	SC93021702	NA	NA
Boresight Antenna Fixture	FBA-01	FBA-SIP01	NA	NA
USB Wideband Power Sensor KEYSIGHT	U2021XA	MY55050005/MY5519 0004/MY55190007/MY 55210005	Jul. 17, 2018	Jul. 16, 2019
Pre-amplifier (18GHz- 40GHz) EMC	EMC184045B	980175	Nov. 14, 2018	Nov. 13, 2019

- Note: 1. The calibration interval of the above test instruments is 12 months and the calibrations are traceable to NML/ROC and NIST/USA.  
 2. The test was performed in HwaYa Chamber 3.



### 4.1.3 Test Procedures

#### For Radiated emission below 30MHz

- a. The EUT was placed on the top of a rotating table 0.8 meters above the ground at a 3 meter chamber room. The table was rotated 360 degrees to determine the position of the highest radiation.
- b. The EUT was set 3 meters away from the interference-receiving antenna, which was mounted on the top of a variable-height antenna tower.
- c. Parallel, perpendicular, and ground-parallel orientations of the antenna are set to make the measurement.
- d. For each suspected emission, the EUT was arranged to its worst case and the rotatable table was turned from 0 degrees to 360 degrees to find the maximum reading.
- e. The test-receiver system was set to Quasi-Peak Detect Function and Specified Bandwidth with Maximum Hold Mode.

**Note:**

1. The resolution bandwidth and video bandwidth of test receiver/spectrum analyzer is 9kHz at frequency below 30MHz.

#### For Radiated emission above 30MHz

- a. The EUT was placed on the top of a rotating table 0.8 meters (for 30MHz ~ 1GHz) / 1.5 meters (for above 1GHz) above the ground at 3 meter chamber room for test. The table was rotated 360 degrees to determine the position of the highest radiation.
- b. The EUT was set 3 meters away from the interference-receiving antenna, which was mounted on the top of a variable-height antenna tower.
- c. The height of antenna is varied from one meter to four meters above the ground to determine the maximum value of the field strength. Both horizontal and vertical polarizations of the antenna are set to make the measurement.
- d. For each suspected emission, the EUT was arranged to its worst case and then the antenna was tuned to heights from 1 meter to 4 meters and the rotatable table was turned from 0 degrees to 360 degrees to find the maximum reading.
- e. The test-receiver system was set to quasi-peak detect function and specified bandwidth with maximum hold mode when the test frequency is below 1 GHz.
- f. The test-receiver system was set to peak and average detect function and specified bandwidth with maximum hold mode when the test frequency is above 1 GHz. If the peak reading value also meets average limit, measurement with the average detector is unnecessary.

**Note:**

1. The resolution bandwidth and video bandwidth of test receiver/spectrum analyzer is 120kHz for Quasi-peak detection (QP) at frequency below 1GHz.
2. The resolution bandwidth of test receiver/spectrum analyzer is 1 MHz and the video bandwidth is 3 MHz for Peak detection (PK) at frequency above 1GHz.
3. The resolution bandwidth of test receiver/spectrum analyzer is 1MHz and the video bandwidth is  $\geq 1/T$  (Duty cycle < 98%) or 10Hz (Duty cycle  $\geq 98\%$ ) for Average detection (AV) at frequency above 1GHz.  
(802.11a: RBW = 1MHz, VBW = 1kHz; 802.11n (HT20): RBW = 1MHz, VBW = 10kHz;  
802.11n (HT40): RBW = 1MHz, VBW = 1kHz; 802.11ac (VHT80) and 802.11ac (VHT80+VHT80): RBW = 1MHz, VBW = 1kHz)
4. All modes of operation were investigated and the worst-case emissions are reported.

#### 4.1.4 Deviation from Test Standard

No deviation.

#### 4.1.5 Test Set Up

##### For Radiated emission below 30MHz

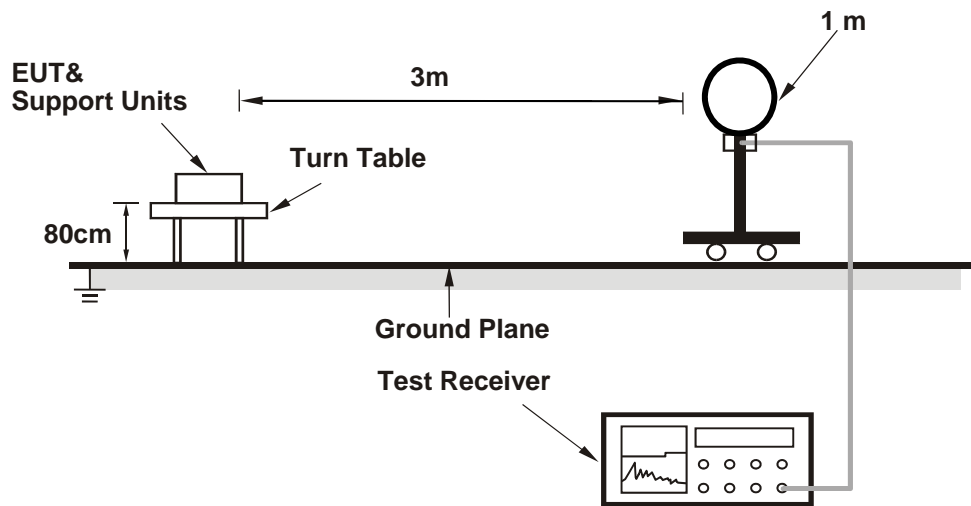

##### For Radiated emission 30MHz to 1GHz

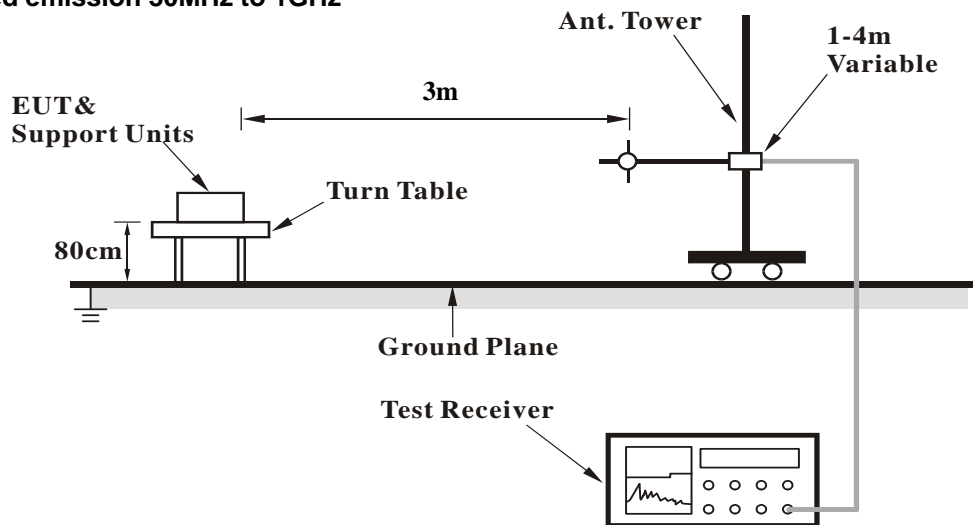

### For Radiated emission above 1GHz

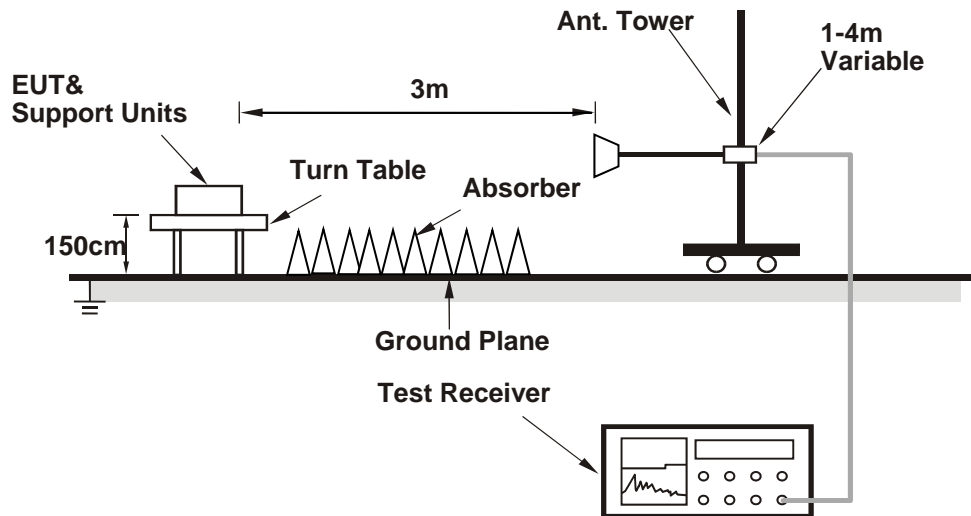

For the actual test configuration, please refer to the attached file (Test Setup Photo).

#### 4.1.6 EUT Operating Conditions

- Placed the EUT on the testing table.
- Prepared a notebook to act as a communication partner and placed it outside of testing area.
- The communication partner connected with EUT via a RJ45 cable and ran a test program (QRCT V3.0.264.0) to enable EUT under transmission condition continuously at specific channel frequency.
- The necessary accessories enable the system in full functions.

#### 4.1.7 Test Results

Above 1GHz data:

802.11a

CHANNEL	TX Channel 36	DETECTOR FUNCTION	Peak (PK)
FREQUENCY RANGE	1GHz ~ 40GHz		Average (AV)

#### ANTENNA POLARITY & TEST DISTANCE: HORIZONTAL AT 3 M

NO.	FREQ. (MHz)	EMISSION LEVEL (dBuV/m)	LIMIT (dBuV/m)	MARGIN (dB)	ANTENNA HEIGHT (m)	TABLE ANGLE (Degree)	RAW VALUE (dBuV)	CORRECTION FACTOR (dB/m)
1	5150.00	65.2 PK	74.0	-8.8	2.85 H	295	60.8	4.4
2	5150.00	52.3 AV	54.0	-1.7	2.85 H	295	47.9	4.4
3	*5180.00	122.9 PK			2.69 H	294	83.4	39.5
4	*5180.00	112.1 AV			2.69 H	294	72.6	39.5
5	#10360.00	57.3 PK	68.2	-10.9	1.32 H	320	41.3	16.0

#### ANTENNA POLARITY & TEST DISTANCE: VERTICAL AT 3 M

NO.	FREQ. (MHz)	EMISSION LEVEL (dBuV/m)	LIMIT (dBuV/m)	MARGIN (dB)	ANTENNA HEIGHT (m)	TABLE ANGLE (Degree)	RAW VALUE (dBuV)	CORRECTION FACTOR (dB/m)
1	5150.00	60.2 PK	74.0	-13.8	2.64 V	345	55.8	4.4
2	5150.00	48.4 AV	54.0	-5.6	2.64 V	345	44.0	4.4
3	*5180.00	119.1 PK			2.71 V	244	79.6	39.5
4	*5180.00	108.5 AV			2.71 V	244	69.0	39.5
5	#10360.00	57.1 PK	68.2	-11.1	1.75 V	343	41.1	16.0

#### Remarks:

1. Emission Level(dBuV/m) = Raw Value(dBuV) + Correction Factor(dB/m)
2. Correction Factor(dB/m) = Antenna Factor(dB/m) + Cable Factor(dB) – Pre-Amplifier Factor(dB)
3. Margin value = Emission Level – Limit value
4. The other emission levels were very low against the limit.
5. " \* ": Fundamental frequency.
6. " # ": The radiated frequency is out of the restricted band.

CHANNEL	TX Channel 40	DETECTOR FUNCTION	Peak (PK)
FREQUENCY RANGE	1GHz ~ 40GHz		Average (AV)

ANTENNA POLARITY & TEST DISTANCE: HORIZONTAL AT 3 M								
NO.	FREQ. (MHz)	EMISSION LEVEL (dBuV/m)	LIMIT (dBuV/m)	MARGIN (dB)	ANTENNA HEIGHT (m)	TABLE ANGLE (Degree)	RAW VALUE (dBuV)	CORRECTION FACTOR (dB/m)
1	5150.00	65.6 PK	74.0	-8.4	2.84 H	297	61.2	4.4
2	5150.00	52.4 AV	54.0	-1.6	2.84 H	297	48.0	4.4
3	*5200.00	125.9 PK			2.56 H	293	86.4	39.5
4	*5200.00	114.9 AV			2.56 H	293	75.4	39.5
5	#10400.00	57.5 PK	68.2	-10.7	1.53 H	333	41.3	16.2

ANTENNA POLARITY & TEST DISTANCE: VERTICAL AT 3 M								
NO.	FREQ. (MHz)	EMISSION LEVEL (dBuV/m)	LIMIT (dBuV/m)	MARGIN (dB)	ANTENNA HEIGHT (m)	TABLE ANGLE (Degree)	RAW VALUE (dBuV)	CORRECTION FACTOR (dB/m)
1	5150.00	60.7 PK	74.0	-13.3	2.56 V	359	56.3	4.4
2	5150.00	48.5 AV	54.0	-5.5	2.56 V	359	44.1	4.4
3	*5200.00	122.1 PK			2.70 V	349	82.6	39.5
4	*5200.00	111.2 AV			2.70 V	349	71.7	39.5
5	#10400.00	57.2 PK	68.2	-11.0	1.71 V	322	41.0	16.2

Remarks:

1. Emission Level(dBuV/m) = Raw Value(dBuV) + Correction Factor(dB/m)
2. Correction Factor(dB/m) = Antenna Factor(dB/m) + Cable Factor(dB) – Pre-Amplifier Factor(dB)
3. Margin value = Emission Level – Limit value
4. The other emission levels were very low against the limit.
5. " \* ": Fundamental frequency.
6. " # ": The radiated frequency is out of the restricted band.

CHANNEL	TX Channel 48	DETECTOR FUNCTION	Peak (PK)
FREQUENCY RANGE	1GHz ~ 40GHz		Average (AV)

ANTENNA POLARITY & TEST DISTANCE: HORIZONTAL AT 3 M								
NO.	FREQ. (MHz)	EMISSION LEVEL (dBuV/m)	LIMIT (dBuV/m)	MARGIN (dB)	ANTENNA HEIGHT (m)	TABLE ANGLE (Degree)	RAW VALUE (dBuV)	CORRECTION FACTOR (dB/m)
1	*5240.00	127.1 PK			2.67 H	291	87.8	39.3
2	*5240.00	116.2 AV			2.67 H	291	76.9	39.3
3	5350.00	59.0 PK	74.0	-15.0	2.51 H	299	54.7	4.3
4	5350.00	45.5 AV	54.0	-8.5	2.51 H	299	41.2	4.3
5	#10480.00	58.8 PK	68.2	-9.4	1.51 H	333	41.8	17.0
ANTENNA POLARITY & TEST DISTANCE: VERTICAL AT 3 M								
NO.	FREQ. (MHz)	EMISSION LEVEL (dBuV/m)	LIMIT (dBuV/m)	MARGIN (dB)	ANTENNA HEIGHT (m)	TABLE ANGLE (Degree)	RAW VALUE (dBuV)	CORRECTION FACTOR (dB/m)
1	*5240.00	123.2 PK			2.75 V	344	83.9	39.3
2	*5240.00	112.4 AV			2.75 V	344	73.1	39.3
3	5350.00	55.8 PK	74.0	-18.2	2.53 V	351	51.5	4.3
4	5350.00	44.2 AV	54.0	-9.8	2.53 V	351	39.9	4.3
5	#10480.00	58.5 PK	68.2	-9.7	1.66 V	331	41.5	17.0

Remarks:

1. Emission Level(dBuV/m) = Raw Value(dBuV) + Correction Factor(dB/m)
2. Correction Factor(dB/m) = Antenna Factor(dB/m) + Cable Factor(dB) – Pre-Amplifier Factor(dB)
3. Margin value = Emission Level – Limit value
4. The other emission levels were very low against the limit.
5. " \* ": Fundamental frequency.
6. " # ": The radiated frequency is out of the restricted band.

CHANNEL	TX Channel 149	DETECTOR FUNCTION	Peak (PK)
FREQUENCY RANGE	1GHz ~ 40GHz		Average (AV)

ANTENNA POLARITY & TEST DISTANCE: HORIZONTAL AT 3 M								
NO.	FREQ. (MHz)	EMISSION LEVEL (dBuV/m)	LIMIT (dBuV/m)	MARGIN (dB)	ANTENNA HEIGHT (m)	TABLE ANGLE (Degree)	RAW VALUE (dBuV)	CORRECTION FACTOR (dB/m)
1	#5635.90	57.7 PK	68.2	-10.5	1.31 H	9	53.2	4.5
2	*5745.00	124.8 PK			1.31 H	9	84.7	40.1
3	*5745.00	113.8 AV			1.31 H	9	73.7	40.1
4	#5935.26	59.4 PK	68.2	-8.8	1.31 H	9	54.1	5.3
5	11490.00	65.0 PK	74.0	-9.0	1.47 H	318	47.0	18.0
6	11490.00	51.8 AV	54.0	-2.2	1.47 H	318	33.8	18.0

ANTENNA POLARITY & TEST DISTANCE: VERTICAL AT 3 M								
NO.	FREQ. (MHz)	EMISSION LEVEL (dBuV/m)	LIMIT (dBuV/m)	MARGIN (dB)	ANTENNA HEIGHT (m)	TABLE ANGLE (Degree)	RAW VALUE (dBuV)	CORRECTION FACTOR (dB/m)
1	#5632.05	57.3 PK	68.2	-10.9	1.56 V	360	52.8	4.5
2	*5745.00	122.5 PK			1.56 V	360	82.4	40.1
3	*5745.00	111.6 AV			1.56 V	360	71.5	40.1
4	#5928.85	60.1 PK	68.2	-8.1	1.56 V	360	54.8	5.3
5	11490.00	63.3 PK	74.0	-10.7	1.54 V	356	45.3	18.0
6	11490.00	49.8 AV	54.0	-4.2	1.54 V	356	31.8	18.0

Remarks:

1. Emission Level(dBuV/m) = Raw Value(dBuV) + Correction Factor(dB/m)
2. Correction Factor(dB/m) = Antenna Factor(dB/m) + Cable Factor(dB) – Pre-Amplifier Factor(dB)
3. Margin value = Emission Level – Limit value
4. The other emission levels were very low against the limit.
5. " \* ": Fundamental frequency.
6. " # ": The radiated frequency is out of the restricted band.

CHANNEL	TX Channel 157	DETECTOR FUNCTION	Peak (PK)
FREQUENCY RANGE	1GHz ~ 40GHz		Average (AV)

ANTENNA POLARITY & TEST DISTANCE: HORIZONTAL AT 3 M								
NO.	FREQ. (MHz)	EMISSION LEVEL (dBuV/m)	LIMIT (dBuV/m)	MARGIN (dB)	ANTENNA HEIGHT (m)	TABLE ANGLE (Degree)	RAW VALUE (dBuV)	CORRECTION FACTOR (dB/m)
1	#5643.59	57.8 PK	68.2	-10.4	1.23 H	7	53.3	4.5
2	*5785.00	125.9 PK			1.23 H	7	85.6	40.3
3	*5785.00	114.7 AV			1.23 H	7	74.4	40.3
4	#5939.10	60.8 PK	68.2	-7.4	1.23 H	7	55.5	5.3
5	11570.00	66.7 PK	74.0	-7.3	1.49 H	317	49.0	17.7
6	11570.00	52.5 AV	54.0	-1.5	1.49 H	317	34.8	17.7

ANTENNA POLARITY & TEST DISTANCE: VERTICAL AT 3 M								
NO.	FREQ. (MHz)	EMISSION LEVEL (dBuV/m)	LIMIT (dBuV/m)	MARGIN (dB)	ANTENNA HEIGHT (m)	TABLE ANGLE (Degree)	RAW VALUE (dBuV)	CORRECTION FACTOR (dB/m)
1	#5629.49	56.2 PK	68.2	-12.0	1.59 V	2	51.7	4.5
2	*5785.00	123.9 PK			1.59 V	2	83.6	40.3
3	*5785.00	112.8 AV			1.59 V	2	72.5	40.3
4	#5969.87	58.2 PK	68.2	-10.0	1.59 V	2	52.9	5.3
5	11570.00	64.5 PK	74.0	-9.5	1.56 V	356	46.8	17.7
6	11570.00	50.4 AV	54.0	-3.6	1.56 V	356	32.7	17.7

Remarks:

1. Emission Level(dBuV/m) = Raw Value(dBuV) + Correction Factor(dB/m)
2. Correction Factor(dB/m) = Antenna Factor(dB/m) + Cable Factor(dB) – Pre-Amplifier Factor(dB)
3. Margin value = Emission Level – Limit value
4. The other emission levels were very low against the limit.
5. " \* ": Fundamental frequency.
6. " # ": The radiated frequency is out of the restricted band.



CHANNEL	TX Channel 165	DETECTOR FUNCTION	Peak (PK)
FREQUENCY RANGE	1GHz ~ 40GHz		Average (AV)

ANTENNA POLARITY & TEST DISTANCE: HORIZONTAL AT 3 M								
NO.	FREQ. (MHz)	EMISSION LEVEL (dBuV/m)	LIMIT (dBuV/m)	MARGIN (dB)	ANTENNA HEIGHT (m)	TABLE ANGLE (Degree)	RAW VALUE (dBuV)	CORRECTION FACTOR (dB/m)
1	#5631.41	57.5 PK	68.2	-10.7	1.26 H	8	53.0	4.5
2	*5825.00	121.8 PK			1.26 H	8	81.4	40.4
3	*5825.00	110.5 AV			1.26 H	8	70.1	40.4
4	#5982.05	60.3 PK	68.2	-7.9	1.26 H	8	54.9	5.4
5	11650.00	66.6 PK	74.0	-7.4	1.32 H	32	49.1	17.5
6	11650.00	52.8 AV	54.0	-1.2	1.32 H	32	35.3	17.5

ANTENNA POLARITY & TEST DISTANCE: VERTICAL AT 3 M								
NO.	FREQ. (MHz)	EMISSION LEVEL (dBuV/m)	LIMIT (dBuV/m)	MARGIN (dB)	ANTENNA HEIGHT (m)	TABLE ANGLE (Degree)	RAW VALUE (dBuV)	CORRECTION FACTOR (dB/m)
1	#5617.95	55.4 PK	68.2	-12.8	1.61 V	3	50.8	4.6
2	*5825.00	118.0 PK			1.61 V	3	77.6	40.4
3	*5825.00	107.0 AV			1.61 V	3	66.6	40.4
4	#5955.13	57.9 PK	68.2	-10.3	1.61 V	3	52.6	5.3
5	11650.00	62.5 PK	74.0	-11.5	1.62 V	9	45.0	17.5
6	11650.00	48.7 AV	54.0	-5.3	1.62 V	9	31.2	17.5

Remarks:

1. Emission Level(dBuV/m) = Raw Value(dBuV) + Correction Factor(dB/m)
2. Correction Factor(dB/m) = Antenna Factor(dB/m) + Cable Factor(dB) – Pre-Amplifier Factor(dB)
3. Margin value = Emission Level – Limit value
4. The other emission levels were very low against the limit.
5. " \* ": Fundamental frequency.
6. " # ": The radiated frequency is out of the restricted band.

## 802.11n (HT20)

CHANNEL	TX Channel 36	DETECTOR FUNCTION	Peak (PK)
FREQUENCY RANGE	1GHz ~ 40GHz		Average (AV)

## ANTENNA POLARITY &amp; TEST DISTANCE: HORIZONTAL AT 3 M

NO.	FREQ. (MHz)	EMISSION LEVEL (dBuV/m)	LIMIT (dBuV/m)	MARGIN (dB)	ANTENNA HEIGHT (m)	TABLE ANGLE (Degree)	RAW VALUE (dBuV)	CORRECTION FACTOR (dB/m)
1	5150.00	64.8 PK	74.0	-9.2	2.52 H	295	60.4	4.4
2	5150.00	52.4 AV	54.0	-1.6	2.52 H	295	48.0	4.4
3	*5180.00	122.0 PK			2.57 H	294	82.5	39.5
4	*5180.00	111.0 AV			2.57 H	294	71.5	39.5
5	#10360.00	57.8 PK	68.2	-10.4	1.43 H	329	41.8	16.0

## ANTENNA POLARITY &amp; TEST DISTANCE: VERTICAL AT 3 M

NO.	FREQ. (MHz)	EMISSION LEVEL (dBuV/m)	LIMIT (dBuV/m)	MARGIN (dB)	ANTENNA HEIGHT (m)	TABLE ANGLE (Degree)	RAW VALUE (dBuV)	CORRECTION FACTOR (dB/m)
1	5150.00	59.9 PK	74.0	-14.1	2.43 V	339	55.5	4.4
2	5150.00	48.2 AV	54.0	-5.8	2.43 V	339	43.8	4.4
3	*5180.00	118.2 PK			2.61 V	349	78.7	39.5
4	*5180.00	107.5 AV			2.61 V	349	68.0	39.5
5	#10360.00	57.5 PK	68.2	-10.7	1.59 V	323	41.5	16.0

## Remarks:

1. Emission Level(dBuV/m) = Raw Value(dBuV) + Correction Factor(dB/m)
2. Correction Factor(dB/m) = Antenna Factor(dB/m) + Cable Factor(dB) – Pre-Amplifier Factor(dB)
3. Margin value = Emission Level – Limit value
4. The other emission levels were very low against the limit.
5. " \* ": Fundamental frequency.
6. " # ": The radiated frequency is out of the restricted band.

CHANNEL	TX Channel 40	DETECTOR FUNCTION	Peak (PK)
FREQUENCY RANGE	1GHz ~ 40GHz		Average (AV)

ANTENNA POLARITY & TEST DISTANCE: HORIZONTAL AT 3 M								
NO.	FREQ. (MHz)	EMISSION LEVEL (dBuV/m)	LIMIT (dBuV/m)	MARGIN (dB)	ANTENNA HEIGHT (m)	TABLE ANGLE (Degree)	RAW VALUE (dBuV)	CORRECTION FACTOR (dB/m)
1	5150.00	65.4 PK	74.0	-8.6	2.72 H	296	61.0	4.4
2	5150.00	52.3 AV	54.0	-1.7	2.72 H	296	47.9	4.4
3	*5200.00	125.8 PK			2.63 H	292	86.3	39.5
4	*5200.00	114.5 AV			2.63 H	292	75.0	39.5
5	#10400.00	57.4 PK	68.2	-10.8	1.39 H	323	41.2	16.2

ANTENNA POLARITY & TEST DISTANCE: VERTICAL AT 3 M								
NO.	FREQ. (MHz)	EMISSION LEVEL (dBuV/m)	LIMIT (dBuV/m)	MARGIN (dB)	ANTENNA HEIGHT (m)	TABLE ANGLE (Degree)	RAW VALUE (dBuV)	CORRECTION FACTOR (dB/m)
1	5150.00	60.7 PK	74.0	-13.3	2.78 V	333	56.3	4.4
2	5150.00	47.7 AV	54.0	-6.3	2.78 V	333	43.3	4.4
3	*5200.00	121.8 PK			2.61 V	350	82.3	39.5
4	*5200.00	110.7 AV			2.61 V	350	71.2	39.5
5	#10400.00	57.1 PK	68.2	-11.1	1.68 V	331	40.9	16.2

Remarks:

1. Emission Level(dBuV/m) = Raw Value(dBuV) + Correction Factor(dB/m)
2. Correction Factor(dB/m) = Antenna Factor(dB/m) + Cable Factor(dB) – Pre-Amplifier Factor(dB)
3. Margin value = Emission Level – Limit value
4. The other emission levels were very low against the limit.
5. " \* ": Fundamental frequency.
6. " # ": The radiated frequency is out of the restricted band.

CHANNEL	TX Channel 48	DETECTOR FUNCTION	Peak (PK)
FREQUENCY RANGE	1GHz ~ 40GHz		Average (AV)

ANTENNA POLARITY & TEST DISTANCE: HORIZONTAL AT 3 M								
NO.	FREQ. (MHz)	EMISSION LEVEL (dBuV/m)	LIMIT (dBuV/m)	MARGIN (dB)	ANTENNA HEIGHT (m)	TABLE ANGLE (Degree)	RAW VALUE (dBuV)	CORRECTION FACTOR (dB/m)
1	*5240.00	127.2 PK			2.61 H	292	87.9	39.3
2	*5240.00	115.8 AV			2.61 H	292	76.5	39.3
3	5350.00	59.0 PK	74.0	-15.0	2.50 H	295	54.7	4.3
4	5350.00	45.5 AV	54.0	-8.5	2.50 H	295	41.2	4.3
5	#10480.00	58.5 PK	68.2	-9.7	1.53 H	313	41.5	17.0
ANTENNA POLARITY & TEST DISTANCE: VERTICAL AT 3 M								
NO.	FREQ. (MHz)	EMISSION LEVEL (dBuV/m)	LIMIT (dBuV/m)	MARGIN (dB)	ANTENNA HEIGHT (m)	TABLE ANGLE (Degree)	RAW VALUE (dBuV)	CORRECTION FACTOR (dB/m)
1	*5240.00	123.3 PK			2.55 V	341	84.0	39.3
2	*5240.00	112.0 AV			2.55 V	341	72.7	39.3
3	5350.00	55.4 PK	74.0	-18.6	2.75 V	350	51.1	4.3
4	5350.00	43.5 AV	54.0	-10.5	2.75 V	350	39.2	4.3
5	#10480.00	58.2 PK	68.2	-10.0	1.79 V	339	41.2	17.0

Remarks:

1. Emission Level(dBuV/m) = Raw Value(dBuV) + Correction Factor(dB/m)
2. Correction Factor(dB/m) = Antenna Factor(dB/m) + Cable Factor(dB) – Pre-Amplifier Factor(dB)
3. Margin value = Emission Level – Limit value
4. The other emission levels were very low against the limit.
5. " \* ": Fundamental frequency.
6. " # ": The radiated frequency is out of the restricted band.

CHANNEL	TX Channel 149	DETECTOR FUNCTION	Peak (PK)
FREQUENCY RANGE	1GHz ~ 40GHz		Average (AV)

ANTENNA POLARITY & TEST DISTANCE: HORIZONTAL AT 3 M								
NO.	FREQ. (MHz)	EMISSION LEVEL (dBuV/m)	LIMIT (dBuV/m)	MARGIN (dB)	ANTENNA HEIGHT (m)	TABLE ANGLE (Degree)	RAW VALUE (dBuV)	CORRECTION FACTOR (dB/m)
1	#5612.18	58.2 PK	68.2	-10.0	1.28 H	8	53.6	4.6
2	*5745.00	124.9 PK			1.28 H	8	84.8	40.1
3	*5745.00	113.2 AV			1.28 H	8	73.1	40.1
4	#5982.05	60.2 PK	68.2	-8.0	1.28 H	8	54.8	5.4
5	11490.00	63.7 PK	74.0	-10.3	1.46 H	316	45.7	18.0
6	11490.00	50.6 AV	54.0	-3.4	1.46 H	316	32.6	18.0

ANTENNA POLARITY & TEST DISTANCE: VERTICAL AT 3 M								
NO.	FREQ. (MHz)	EMISSION LEVEL (dBuV/m)	LIMIT (dBuV/m)	MARGIN (dB)	ANTENNA HEIGHT (m)	TABLE ANGLE (Degree)	RAW VALUE (dBuV)	CORRECTION FACTOR (dB/m)
1	#5619.87	56.3 PK	68.2	-11.9	1.59 V	3	51.7	4.6
2	*5745.00	122.8 PK			1.59 V	3	82.7	40.1
3	*5745.00	111.4 AV			1.59 V	3	71.3	40.1
4	#5942.95	57.9 PK	68.2	-10.3	1.59 V	3	52.6	5.3
5	11490.00	62.3 PK	74.0	-11.7	1.56 V	357	44.3	18.0
6	11490.00	49.1 AV	54.0	-4.9	1.56 V	357	31.1	18.0

Remarks:

1. Emission Level(dBuV/m) = Raw Value(dBuV) + Correction Factor(dB/m)
2. Correction Factor(dB/m) = Antenna Factor(dB/m) + Cable Factor(dB) – Pre-Amplifier Factor(dB)
3. Margin value = Emission Level – Limit value
4. The other emission levels were very low against the limit.
5. " \* ": Fundamental frequency.
6. " # ": The radiated frequency is out of the restricted band.

CHANNEL	TX Channel 157	DETECTOR FUNCTION	Peak (PK) Average (AV)
FREQUENCY RANGE	1GHz ~ 40GHz		

ANTENNA POLARITY & TEST DISTANCE: HORIZONTAL AT 3 M								
NO.	FREQ. (MHz)	EMISSION LEVEL (dBuV/m)	LIMIT (dBuV/m)	MARGIN (dB)	ANTENNA HEIGHT (m)	TABLE ANGLE (Degree)	RAW VALUE (dBuV)	CORRECTION FACTOR (dB/m)
1	#5607.05	57.6 PK	68.2	-10.6	1.22 H	7	53.0	4.6
2	*5785.00	125.3 PK			1.22 H	7	85.0	40.3
3	*5785.00	113.8 AV			1.22 H	7	73.5	40.3
4	#5948.08	60.1 PK	68.2	-8.1	1.22 H	7	54.8	5.3
5	11570.00	65.1 PK	74.0	-8.9	1.50 H	316	47.4	17.7
6	11570.00	51.3 AV	54.0	-2.7	1.50 H	316	33.6	17.7

ANTENNA POLARITY & TEST DISTANCE: VERTICAL AT 3 M								
NO.	FREQ. (MHz)	EMISSION LEVEL (dBuV/m)	LIMIT (dBuV/m)	MARGIN (dB)	ANTENNA HEIGHT (m)	TABLE ANGLE (Degree)	RAW VALUE (dBuV)	CORRECTION FACTOR (dB/m)
1	#5608.33	55.9 PK	68.2	-12.3	1.59 V	2	51.3	4.6
2	*5785.00	123.7 PK			1.59 V	2	83.4	40.3
3	*5785.00	112.3 AV			1.59 V	2	72.0	40.3
4	#5998.72	58.1 PK	68.2	-10.1	1.59 V	2	52.7	5.4
5	11570.00	63.1 PK	74.0	-10.9	1.55 V	356	45.4	17.7
6	11570.00	49.2 AV	54.0	-4.8	1.55 V	356	31.5	17.7

Remarks:

1. Emission Level(dBuV/m) = Raw Value(dBuV) + Correction Factor(dB/m)
2. Correction Factor(dB/m) = Antenna Factor(dB/m) + Cable Factor(dB) – Pre-Amplifier Factor(dB)
3. Margin value = Emission Level – Limit value
4. The other emission levels were very low against the limit.
5. " \* ": Fundamental frequency.
6. " # ": The radiated frequency is out of the restricted band.

CHANNEL	TX Channel 165	DETECTOR FUNCTION	Peak (PK)
FREQUENCY RANGE	1GHz ~ 40GHz		Average (AV)

ANTENNA POLARITY & TEST DISTANCE: HORIZONTAL AT 3 M								
NO.	FREQ. (MHz)	EMISSION LEVEL (dBuV/m)	LIMIT (dBuV/m)	MARGIN (dB)	ANTENNA HEIGHT (m)	TABLE ANGLE (Degree)	RAW VALUE (dBuV)	CORRECTION FACTOR (dB/m)
1	#5619.23	57.4 PK	68.2	-10.8	1.24 H	8	52.8	4.6
2	*5825.00	122.4 PK			1.24 H	8	82.0	40.4
3	*5825.00	110.8 AV			1.24 H	8	70.4	40.4
4	#5939.10	60.6 PK	68.2	-7.6	1.24 H	8	55.3	5.3
5	11650.00	66.9 PK	74.0	-7.1	1.36 H	31	49.4	17.5
6	11650.00	52.9 AV	54.0	-1.1	1.36 H	31	35.4	17.5

ANTENNA POLARITY & TEST DISTANCE: VERTICAL AT 3 M								
NO.	FREQ. (MHz)	EMISSION LEVEL (dBuV/m)	LIMIT (dBuV/m)	MARGIN (dB)	ANTENNA HEIGHT (m)	TABLE ANGLE (Degree)	RAW VALUE (dBuV)	CORRECTION FACTOR (dB/m)
1	#5620.51	55.1 PK	68.2	-13.1	1.65 V	2	50.5	4.6
2	*5825.00	119.1 PK			1.65 V	2	78.7	40.4
3	*5825.00	107.7 AV			1.65 V	2	67.3	40.4
4	#5933.33	58.0 PK	68.2	-10.2	1.65 V	2	52.7	5.3
5	11650.00	62.4 PK	74.0	-11.6	3.00 V	331	44.9	17.5
6	11650.00	48.7 AV	54.0	-5.3	3.00 V	331	31.2	17.5

Remarks:

1. Emission Level(dBuV/m) = Raw Value(dBuV) + Correction Factor(dB/m)
2. Correction Factor(dB/m) = Antenna Factor(dB/m) + Cable Factor(dB) – Pre-Amplifier Factor(dB)
3. Margin value = Emission Level – Limit value
4. The other emission levels were very low against the limit.
5. " \* ": Fundamental frequency.
6. " # ": The radiated frequency is out of the restricted band.

## 802.11n (HT40)

CHANNEL	TX Channel 38	DETECTOR FUNCTION	Peak (PK)
FREQUENCY RANGE	1GHz ~ 40GHz		Average (AV)

## ANTENNA POLARITY &amp; TEST DISTANCE: HORIZONTAL AT 3 M

NO.	FREQ. (MHz)	EMISSION LEVEL (dBuV/m)	LIMIT (dBuV/m)	MARGIN (dB)	ANTENNA HEIGHT (m)	TABLE ANGLE (Degree)	RAW VALUE (dBuV)	CORRECTION FACTOR (dB/m)
1	5150.00	65.4 PK	74.0	-8.6	2.63 H	301	61.0	4.4
2	5150.00	52.4 AV	54.0	-1.6	2.63 H	301	48.0	4.4
3	*5190.00	119.2 PK			2.51 H	295	79.7	39.5
4	*5190.00	108.8 AV			2.51 H	295	69.3	39.5
5	#10380.00	57.7 PK	68.2	-10.5	1.53 H	337	41.5	16.2

## ANTENNA POLARITY &amp; TEST DISTANCE: VERTICAL AT 3 M

NO.	FREQ. (MHz)	EMISSION LEVEL (dBuV/m)	LIMIT (dBuV/m)	MARGIN (dB)	ANTENNA HEIGHT (m)	TABLE ANGLE (Degree)	RAW VALUE (dBuV)	CORRECTION FACTOR (dB/m)
1	5150.00	59.1 PK	74.0	-14.9	2.47 V	339	54.7	4.4
2	5150.00	48.3 AV	54.0	-5.7	2.47 V	339	43.9	4.4
3	*5190.00	115.5 PK			2.66 V	346	76.0	39.5
4	*5190.00	105.0 AV			2.66 V	346	65.5	39.5
5	#10380.00	57.3 PK	68.2	-10.9	1.81 V	340	41.1	16.2

## Remarks:

1. Emission Level(dBuV/m) = Raw Value(dBuV) + Correction Factor(dB/m)
2. Correction Factor(dB/m) = Antenna Factor(dB/m) + Cable Factor(dB) – Pre-Amplifier Factor(dB)
3. Margin value = Emission Level – Limit value
4. The other emission levels were very low against the limit.
5. " \* ": Fundamental frequency.
6. " # ": The radiated frequency is out of the restricted band.



CHANNEL	TX Channel 46	DETECTOR FUNCTION	Peak (PK)
FREQUENCY RANGE	1GHz ~ 40GHz		Average (AV)

ANTENNA POLARITY & TEST DISTANCE: HORIZONTAL AT 3 M								
NO.	FREQ. (MHz)	EMISSION LEVEL (dBuV/m)	LIMIT (dBuV/m)	MARGIN (dB)	ANTENNA HEIGHT (m)	TABLE ANGLE (Degree)	RAW VALUE (dBuV)	CORRECTION FACTOR (dB/m)
1	5150.00	67.4 PK	74.0	-6.6	2.50 H	295	63.0	4.4
2	5150.00	52.4 AV	54.0	-1.6	2.50 H	295	48.0	4.4
3	*5230.00	123.2 PK			2.58 H	292	83.9	39.3
4	*5230.00	112.6 AV			2.58 H	292	73.3	39.3
5	#10460.00	59.5 PK	68.2	-8.7	1.43 H	318	42.7	16.8

ANTENNA POLARITY & TEST DISTANCE: VERTICAL AT 3 M								
NO.	FREQ. (MHz)	EMISSION LEVEL (dBuV/m)	LIMIT (dBuV/m)	MARGIN (dB)	ANTENNA HEIGHT (m)	TABLE ANGLE (Degree)	RAW VALUE (dBuV)	CORRECTION FACTOR (dB/m)
1	5150.00	62.6 PK	74.0	-11.4	2.74 V	339	58.2	4.4
2	5150.00	52.1 AV	54.0	-1.9	2.74 V	339	47.7	4.4
3	*5230.00	119.5 PK			2.55 V	342	80.2	39.3
4	*5230.00	109.2 AV			2.55 V	342	69.9	39.3
5	#10460.00	58.8 PK	68.2	-9.4	1.70 V	337	42.0	16.8

Remarks:

1. Emission Level(dBuV/m) = Raw Value(dBuV) + Correction Factor(dB/m)
2. Correction Factor(dB/m) = Antenna Factor(dB/m) + Cable Factor(dB) – Pre-Amplifier Factor(dB)
3. Margin value = Emission Level – Limit value
4. The other emission levels were very low against the limit.
5. " \* ": Fundamental frequency.
6. " # ": The radiated frequency is out of the restricted band.

CHANNEL	TX Channel 151	DETECTOR FUNCTION	Peak (PK)
FREQUENCY RANGE	1GHz ~ 40GHz		Average (AV)

ANTENNA POLARITY & TEST DISTANCE: HORIZONTAL AT 3 M								
NO.	FREQ. (MHz)	EMISSION LEVEL (dBuV/m)	LIMIT (dBuV/m)	MARGIN (dB)	ANTENNA HEIGHT (m)	TABLE ANGLE (Degree)	RAW VALUE (dBuV)	CORRECTION FACTOR (dB/m)
1	#5646.79	59.1 PK	68.2	-9.1	1.15 H	8	54.6	4.5
2	*5755.00	121.9 PK			1.15 H	8	81.8	40.1
3	*5755.00	110.9 AV			1.15 H	8	70.8	40.1
4	#5956.41	59.3 PK	68.2	-8.9	1.15 H	8	54.0	5.3
5	11510.00	62.6 PK	74.0	-11.4	1.50 H	315	44.5	18.1
6	11510.00	48.8 AV	54.0	-5.2	1.50 H	315	30.7	18.1

ANTENNA POLARITY & TEST DISTANCE: VERTICAL AT 3 M								
NO.	FREQ. (MHz)	EMISSION LEVEL (dBuV/m)	LIMIT (dBuV/m)	MARGIN (dB)	ANTENNA HEIGHT (m)	TABLE ANGLE (Degree)	RAW VALUE (dBuV)	CORRECTION FACTOR (dB/m)
1	#5629.49	56.5 PK	68.2	-11.7	1.59 V	4	52.0	4.5
2	*5755.00	119.9 PK			1.59 V	4	79.8	40.1
3	*5755.00	108.5 AV			1.59 V	4	68.4	40.1
4	#5983.33	57.6 PK	68.2	-10.6	1.59 V	4	52.2	5.4
5	11510.00	61.4 PK	74.0	-12.6	1.59 V	356	43.3	18.1
6	11510.00	48.3 AV	54.0	-5.7	1.59 V	356	30.2	18.1

Remarks:

1. Emission Level(dBuV/m) = Raw Value(dBuV) + Correction Factor(dB/m)
2. Correction Factor(dB/m) = Antenna Factor(dB/m) + Cable Factor(dB) – Pre-Amplifier Factor(dB)
3. Margin value = Emission Level – Limit value
4. The other emission levels were very low against the limit.
5. " \* ": Fundamental frequency.
6. " # ": The radiated frequency is out of the restricted band.

CHANNEL	TX Channel 159	DETECTOR FUNCTION	Peak (PK)
FREQUENCY RANGE	1GHz ~ 40GHz		Average (AV)

ANTENNA POLARITY & TEST DISTANCE: HORIZONTAL AT 3 M								
NO.	FREQ. (MHz)	EMISSION LEVEL (dBuV/m)	LIMIT (dBuV/m)	MARGIN (dB)	ANTENNA HEIGHT (m)	TABLE ANGLE (Degree)	RAW VALUE (dBuV)	CORRECTION FACTOR (dB/m)
1	#5619.87	57.4 PK	68.2	-10.8	1.23 H	9	52.8	4.6
2	*5795.00	122.9 PK			1.23 H	9	82.5	40.4
3	*5795.00	112.4 AV			1.23 H	9	72.0	40.4
4	#5928.85	61.1 PK	68.2	-7.1	1.23 H	9	55.8	5.3
5	11590.00	65.3 PK	74.0	-8.7	1.60 H	10	47.7	17.6
6	11590.00	52.0 AV	54.0	-2.0	1.60 H	10	34.4	17.6

ANTENNA POLARITY & TEST DISTANCE: VERTICAL AT 3 M								
NO.	FREQ. (MHz)	EMISSION LEVEL (dBuV/m)	LIMIT (dBuV/m)	MARGIN (dB)	ANTENNA HEIGHT (m)	TABLE ANGLE (Degree)	RAW VALUE (dBuV)	CORRECTION FACTOR (dB/m)
1	#5641.03	55.7 PK	68.2	-12.5	1.58 V	3	51.2	4.5
2	*5795.00	120.7 PK			1.58 V	3	80.3	40.4
3	*5795.00	109.4 AV			1.58 V	3	69.0	40.4
4	#5937.18	59.2 PK	68.2	-9.0	1.58 V	3	53.9	5.3
5	11590.00	61.2 PK	74.0	-12.8	1.56 V	7	43.6	17.6
6	11590.00	48.8 AV	54.0	-5.2	1.56 V	7	31.2	17.6

Remarks:

1. Emission Level(dBuV/m) = Raw Value(dBuV) + Correction Factor(dB/m)
2. Correction Factor(dB/m) = Antenna Factor(dB/m) + Cable Factor(dB) – Pre-Amplifier Factor(dB)
3. Margin value = Emission Level – Limit value
4. The other emission levels were very low against the limit.
5. " \* ": Fundamental frequency.
6. " # ": The radiated frequency is out of the restricted band.

## 802.11ac (VHT80)

CHANNEL	TX Channel 42	DETECTOR FUNCTION	Peak (PK)
FREQUENCY RANGE	1GHz ~ 40GHz		Average (AV)

ANTENNA POLARITY & TEST DISTANCE: HORIZONTAL AT 3 M								
NO.	FREQ. (MHz)	EMISSION LEVEL (dBuV/m)	LIMIT (dBuV/m)	MARGIN (dB)	ANTENNA HEIGHT (m)	TABLE ANGLE (Degree)	RAW VALUE (dBuV)	CORRECTION FACTOR (dB/m)
1	5150.00	66.3 PK	74.0	-7.7	1.62 H	295	61.9	4.4
2	5150.00	52.2 AV	54.0	-1.8	1.62 H	295	47.8	4.4
3	*5210.00	116.5 PK			2.67 H	293	77.1	39.4
4	*5210.00	105.5 AV			2.67 H	293	66.1	39.4
5	5350.00	57.6 PK	74.0	-16.4	1.93 H	303	53.3	4.3
6	5350.00	44.4 AV	54.0	-9.6	1.93 H	303	40.1	4.3
7	#10420.00	57.7 PK	68.2	-10.5	1.49 H	309	41.2	16.5
ANTENNA POLARITY & TEST DISTANCE: VERTICAL AT 3 M								
NO.	FREQ. (MHz)	EMISSION LEVEL (dBuV/m)	LIMIT (dBuV/m)	MARGIN (dB)	ANTENNA HEIGHT (m)	TABLE ANGLE (Degree)	RAW VALUE (dBuV)	CORRECTION FACTOR (dB/m)
1	5150.00	65.9 PK	74.0	-8.1	1.60 V	16	61.5	4.4
2	5150.00	50.4 AV	54.0	-3.6	1.60 V	16	46.0	4.4
3	*5210.00	112.9 PK			1.45 V	14	73.5	39.4
4	*5210.00	102.6 AV			1.45 V	14	63.2	39.4
5	5350.00	60.4 PK	74.0	-13.6	1.66 V	11	56.1	4.3
6	5350.00	46.3 AV	54.0	-7.7	1.66 V	11	42.0	4.3
7	#10420.00	57.5 PK	68.2	-10.7	1.69 V	339	41.0	16.5

## Remarks:

1. Emission Level(dBuV/m) = Raw Value(dBuV) + Correction Factor(dB/m)
2. Correction Factor(dB/m) = Antenna Factor(dB/m) + Cable Factor(dB) – Pre-Amplifier Factor(dB)
3. Margin value = Emission Level – Limit value
4. The other emission levels were very low against the limit.
5. " \* ": Fundamental frequency.
6. " # ": The radiated frequency is out of the restricted band.

CHANNEL	TX Channel 155	DETECTOR FUNCTION	Peak (PK)
FREQUENCY RANGE	1GHz ~ 40GHz		Average (AV)

ANTENNA POLARITY & TEST DISTANCE: HORIZONTAL AT 3 M								
NO.	FREQ. (MHz)	EMISSION LEVEL (dBuV/m)	LIMIT (dBuV/m)	MARGIN (dB)	ANTENNA HEIGHT (m)	TABLE ANGLE (Degree)	RAW VALUE (dBuV)	CORRECTION FACTOR (dB/m)
1	#5647.44	61.1 PK	68.2	-7.1	1.28 H	10	56.6	4.5
2	#5650.00	63.7 PK	68.2	-4.5	1.00 H	8	59.2	4.5
3	*5775.00	116.3 PK			1.28 H	10	76.0	40.3
4	*5775.00	105.1 AV			1.28 H	10	64.8	40.3
5	#5925.00	66.8 PK	68.2	-1.4	2.30 H	3	61.5	5.3
6	#5926.92	62.0 PK	68.2	-6.2	1.28 H	10	56.7	5.3
7	11550.00	61.1 PK	74.0	-12.9	1.26 H	32	43.2	17.9
8	11550.00	47.1 AV	54.0	-6.9	1.26 H	32	29.2	17.9
ANTENNA POLARITY & TEST DISTANCE: VERTICAL AT 3 M								
NO.	FREQ. (MHz)	EMISSION LEVEL (dBuV/m)	LIMIT (dBuV/m)	MARGIN (dB)	ANTENNA HEIGHT (m)	TABLE ANGLE (Degree)	RAW VALUE (dBuV)	CORRECTION FACTOR (dB/m)
1	#5649.36	61.7 PK	68.2	-6.5	1.60 V	1	57.2	4.5
2	#5650.00	66.9 PK	68.2	-1.3	2.03 V	27	62.4	4.5
3	*5775.00	112.7 PK			1.60 V	1	72.4	40.3
4	*5775.00	102.2 AV			1.60 V	1	61.9	40.3
<b>5</b>	<b>#5925.00</b>	<b>67.2 PK</b>	<b>68.2</b>	<b>-1.0</b>	<b>1.54 V</b>	<b>360</b>	<b>61.9</b>	<b>5.3</b>
6	#5931.41	63.4 PK	68.2	-4.8	1.60 V	1	58.1	5.3
7	11550.00	58.3 PK	74.0	-15.7	1.61 V	352	40.4	17.9
8	11550.00	45.3 AV	54.0	-8.7	1.61 V	352	27.4	17.9

Remarks:

1. Emission Level(dBuV/m) = Raw Value(dBuV) + Correction Factor(dB/m)
2. Correction Factor(dB/m) = Antenna Factor(dB/m) + Cable Factor(dB) – Pre-Amplifier Factor(dB)
3. Margin value = Emission Level – Limit value
4. The other emission levels were very low against the limit.
5. " \* ": Fundamental frequency.
6. " # ": The radiated frequency is out of the restricted band.

## 802.11ac (VHT80+VHT80)

CHANNEL	TX Channel 42+155	DETECTOR FUNCTION	Peak (PK)
FREQUENCY RANGE	1GHz ~ 40GHz		Average (AV)

## ANTENNA POLARITY &amp; TEST DISTANCE: HORIZONTAL AT 3 M

NO.	FREQ. (MHz)	EMISSION LEVEL (dBuV/m)	LIMIT (dBuV/m)	MARGIN (dB)	ANTENNA HEIGHT (m)	TABLE ANGLE (Degree)	RAW VALUE (dBuV)	CORRECTION FACTOR (dB/m)
1	5150.00	67.3 PK	74.0	-6.7	1.66 H	331	62.9	4.4
2	5150.00	52.2 AV	54.0	-1.8	1.66 H	331	47.8	4.4
3	*5210.00	111.9 PK			1.59 H	331	72.5	39.4
4	*5210.00	102.0 AV			1.59 H	331	62.6	39.4
5	5350.00	59.3 PK	74.0	-14.7	1.70 H	340	55.0	4.3
6	5350.00	45.4 AV	54.0	-8.6	1.70 H	340	41.1	4.3
7	#5610.26	57.0 PK	68.2	-11.2	2.90 H	284	52.4	4.6
8	#5650.00	58.3 PK	68.2	-9.9	3.01 H	293	53.8	4.5
9	*5775.00	108.9 PK			2.90 H	284	68.6	40.3
10	*5775.00	98.9 AV			2.90 H	284	58.6	40.3
11	#5925.00	59.8 PK	68.2	-8.4	2.99 H	289	54.5	5.3
12	#5973.08	58.0 PK	68.2	-10.2	2.90 H	284	52.6	5.4
13	#10420.00	58.7 PK	68.2	-9.5	1.75 H	301	42.2	16.5
14	11550.00	61.0 PK	74.0	-13.0	1.50 H	101	43.1	17.9
15	11550.00	46.8 AV	54.0	-7.2	1.50 H	101	28.9	17.9

## Remarks:

1. Emission Level(dBuV/m) = Raw Value(dBuV) + Correction Factor(dB/m)
2. Correction Factor(dB/m) = Antenna Factor(dB/m) + Cable Factor(dB) – Pre-Amplifier Factor(dB)
3. Margin value = Emission Level – Limit value
4. The other emission levels were very low against the limit.
5. " \* ": Fundamental frequency.
6. " # ": The radiated frequency is out of the restricted band.

CHANNEL	TX Channel 42+155	DETECTOR FUNCTION	Peak (PK) Average (AV)
FREQUENCY RANGE	1GHz ~ 40GHz		

ANTENNA POLARITY & TEST DISTANCE: VERTICAL AT 3 M								
NO.	FREQ. (MHz)	EMISSION LEVEL (dBuV/m)	LIMIT (dBuV/m)	MARGIN (dB)	ANTENNA HEIGHT (m)	TABLE ANGLE (Degree)	RAW VALUE (dBuV)	CORRECTION FACTOR (dB/m)
1	5150.00	59.7 PK	74.0	-14.3	3.93 V	23	55.3	4.4
2	5150.00	46.4 AV	54.0	-7.6	3.93 V	23	42.0	4.4
3	*5210.00	105.3 PK			3.85 V	16	65.9	39.4
4	*5210.00	95.4 AV			3.85 V	16	56.0	39.4
5	5350.00	57.7 PK	74.0	-16.3	3.87 V	19	53.4	4.3
6	5350.00	44.4 AV	54.0	-9.6	3.87 V	19	40.1	4.3
7	#5647.44	57.8 PK	68.2	-10.4	2.24 V	25	53.3	4.5
8	#5650.00	58.5 PK	68.2	-9.7	2.53 V	45	54.0	4.5
9	*5775.00	109.6 PK			2.24 V	25	69.3	40.3
10	*5775.00	98.7 AV			2.24 V	25	58.4	40.3
11	#5925.00	60.1 PK	68.2	-8.1	2.37 V	33	54.8	5.3
12	#5955.77	58.8 PK	68.2	-9.4	2.24 V	25	53.5	5.3
13	#10420.00	58.2 PK	68.2	-10.0	2.85 V	196	41.7	16.5
14	11550.00	60.7 PK	74.0	-13.3	2.63 V	235	42.8	17.9
15	11550.00	46.2 AV	54.0	-7.8	2.63 V	235	28.3	17.9

Remarks:

1. Emission Level(dBuV/m) = Raw Value(dBuV) + Correction Factor(dB/m)
2. Correction Factor(dB/m) = Antenna Factor(dB/m) + Cable Factor(dB) – Pre-Amplifier Factor(dB)
3. Margin value = Emission Level – Limit value
4. The other emission levels were very low against the limit.
5. " \* ": Fundamental frequency.
6. " # ": The radiated frequency is out of the restricted band.

Below 1GHz Worst-Case Data: 802.11a

CHANNEL	TX Channel 48	DETECTOR FUNCTION	Quasi-Peak (QP)
FREQUENCY RANGE	9kHz ~ 1GHz	TEST MODE	A

ANTENNA POLARITY & TEST DISTANCE: HORIZONTAL AT 3 M								
NO.	FREQ. (MHz)	EMISSION LEVEL (dBuV/m)	LIMIT (dBuV/m)	MARGIN (dB)	ANTENNA HEIGHT (m)	TABLE ANGLE (Degree)	RAW VALUE (dBuV)	CORRECTION FACTOR (dB/m)
1	49.34	32.7 QP	40.0	-7.3	1.99 H	85	42.4	-9.7
2	90.17	32.9 QP	43.5	-10.6	1.99 H	295	47.5	-14.6
3	181.55	30.1 QP	43.5	-13.4	1.49 H	85	40.5	-10.4
4	285.94	44.3 QP	46.0	-1.7	1.00 H	78	51.9	-7.6
5	432.37	39.4 QP	46.0	-6.6	1.99 H	204	43.9	-4.5
6	500.42	43.0 QP	46.0	-3.0	1.49 H	99	46.6	-3.6

Remarks:

1. Emission Level(dBuV/m) = Raw Value(dBuV) + Correction Factor(dB/m)
2. Correction Factor(dB/m) = Antenna Factor(dB/m) + Cable Factor(dB) – Pre-Amplifier Factor(dB)
3. The other emission levels were very low against the limit of frequency range 30MHz~1000MHz.
4. Margin value = Emission Level – Limit value
5. The emission levels were very low against the limit of frequency range 9kHz~30MHz: the amplitude of spurious emissions attenuated more than 20dB below the permissible value to be report.

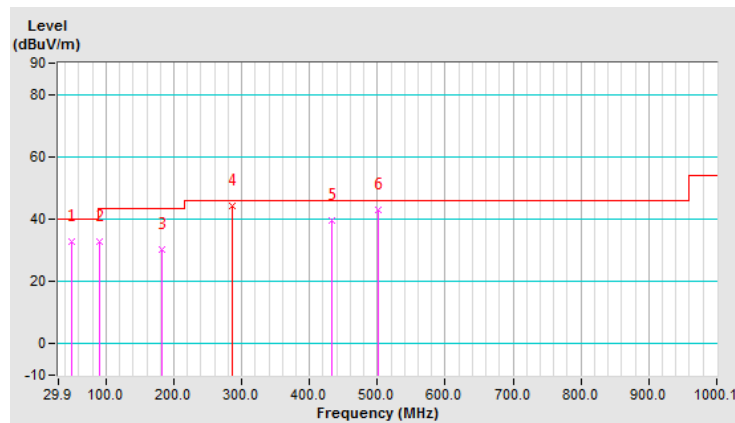



CHANNEL	TX Channel 48	DETECTOR FUNCTION	Quasi-Peak (QP)
FREQUENCY RANGE	9kHz ~ 1GHz	TEST MODE	A

ANTENNA POLARITY & TEST DISTANCE: VERTICAL AT 3 M								
NO.	FREQ. (MHz)	EMISSION LEVEL (dBuV/m)	LIMIT (dBuV/m)	MARGIN (dB)	ANTENNA HEIGHT (m)	TABLE ANGLE (Degree)	RAW VALUE (dBuV)	CORRECTION FACTOR (dB/m)
1	51.69	38.7 QP	40.0	-1.3	1.00 V	324	48.4	-9.7
2	62.95	38.1 QP	40.0	-1.9	1.50 V	16	48.4	-10.3
3	284.60	37.6 QP	46.0	-8.4	1.00 V	40	45.3	-7.7
4	434.31	41.1 QP	46.0	-4.9	1.00 V	6	45.6	-4.5
5	500.42	42.6 QP	46.0	-3.4	1.00 V	319	46.2	-3.6
6	624.85	40.6 QP	46.0	-5.4	1.50 V	16	41.3	-0.7

Remarks:

1. Emission Level(dBuV/m) = Raw Value(dBuV) + Correction Factor(dB/m)
2. Correction Factor(dB/m) = Antenna Factor(dB/m) + Cable Factor(dB) – Pre-Amplifier Factor(dB)
3. The other emission levels were very low against the limit of frequency range 30MHz~1000MHz.
4. Margin value = Emission Level – Limit value
5. The emission levels were very low against the limit of frequency range 9kHz~30MHz: the amplitude of spurious emissions attenuated more than 20dB below the permissible value to be report.

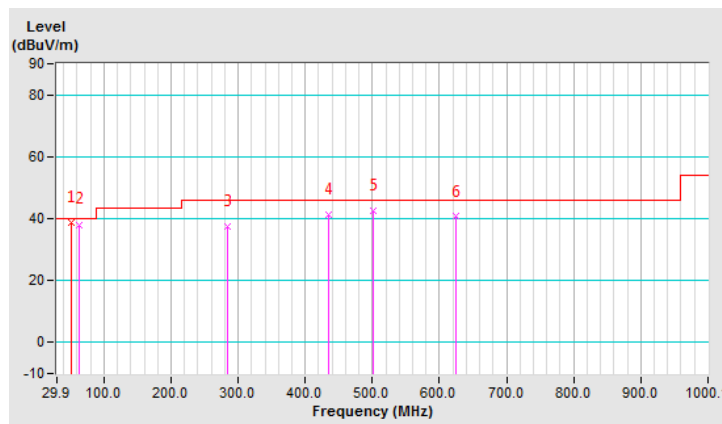

CHANNEL	TX Channel 48	DETECTOR FUNCTION	Quasi-Peak (QP)
FREQUENCY RANGE	9kHz ~ 1GHz	TEST MODE	B

**ANTENNA POLARITY & TEST DISTANCE: HORIZONTAL AT 3 M**

NO.	FREQ. (MHz)	EMISSION LEVEL (dBuV/m)	LIMIT (dBuV/m)	MARGIN (dB)	ANTENNA HEIGHT (m)	TABLE ANGLE (Degree)	RAW VALUE (dBuV)	CORRECTION FACTOR (dB/m)
1	181.55	27.8 QP	43.5	-15.7	2.00 H	10	38.2	-10.4
2	269.05	38.7 QP	46.0	-7.3	1.00 H	67	47.0	-8.3
3	286.55	44.5 QP	46.0	-1.5	1.00 H	78	52.1	-7.6
4	374.04	37.2 QP	46.0	-8.8	1.50 H	134	43.1	-5.9
5	585.97	38.6 QP	46.0	-7.4	1.00 H	11	40.1	-1.5
6	624.85	41.7 QP	46.0	-4.3	1.00 H	50	42.4	-0.7

**Remarks:**

1. Emission Level(dBuV/m) = Raw Value(dBuV) + Correction Factor(dB/m)
2. Correction Factor(dB/m) = Antenna Factor(dB/m) + Cable Factor(dB) – Pre-Amplifier Factor(dB)
3. The other emission levels were very low against the limit of frequency range 30MHz~1000MHz.
4. Margin value = Emission Level – Limit value
5. The emission levels were very low against the limit of frequency range 9kHz~30MHz: the amplitude of spurious emissions attenuated more than 20dB below the permissible value to be report.

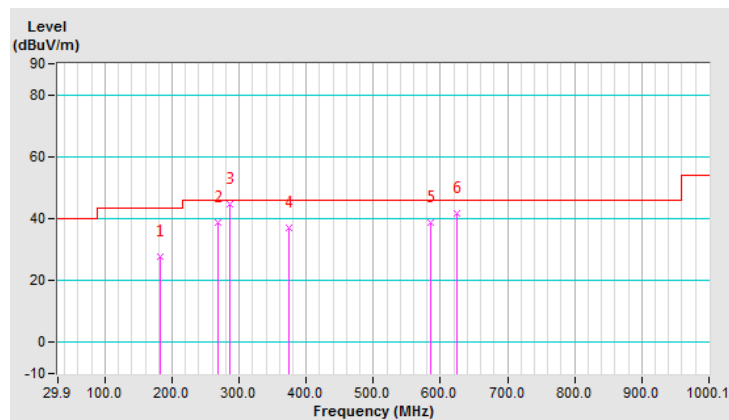

CHANNEL	TX Channel 48	DETECTOR FUNCTION	Quasi-Peak (QP)
FREQUENCY RANGE	9kHz ~ 1GHz	TEST MODE	B

ANTENNA POLARITY & TEST DISTANCE: VERTICAL AT 3 M								
NO.	FREQ. (MHz)	EMISSION LEVEL (dBuV/m)	LIMIT (dBuV/m)	MARGIN (dB)	ANTENNA HEIGHT (m)	TABLE ANGLE (Degree)	RAW VALUE (dBuV)	CORRECTION FACTOR (dB/m)
1	47.40	30.7 QP	40.0	-9.3	1.50 V	357	40.4	-9.7
2	220.44	29.3 QP	46.0	-16.7	1.00 V	334	39.9	-10.6
3	284.60	39.2 QP	46.0	-6.8	1.00 V	189	46.9	-7.7
4	432.37	43.1 QP	46.0	-2.9	2.00 V	357	47.6	-4.5
5	500.42	39.5 QP	46.0	-6.5	1.50 V	4	43.1	-3.6
6	624.85	36.0 QP	46.0	-10.0	1.00 V	322	36.7	-0.7

Remarks:

1. Emission Level(dBuV/m) = Raw Value(dBuV) + Correction Factor(dB/m)
2. Correction Factor(dB/m) = Antenna Factor(dB/m) + Cable Factor(dB) – Pre-Amplifier Factor(dB)
3. The other emission levels were very low against the limit of frequency range 30MHz~1000MHz.
4. Margin value = Emission Level – Limit value
5. The emission levels were very low against the limit of frequency range 9kHz~30MHz: the amplitude of spurious emissions attenuated more than 20dB below the permissible value to be report.

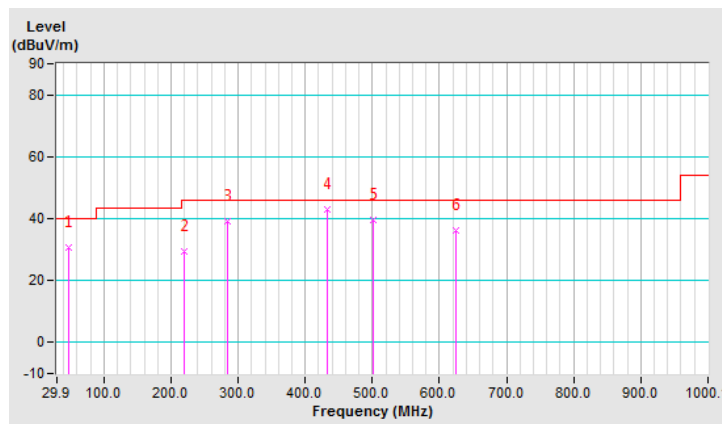

## 4.2 Conducted Emission Measurement

### 4.2.1 Limits of Conducted Emission Measurement

Frequency (MHz)	Conducted Limit (dBuV)	
	Quasi-peak	Average
0.15 - 0.5	66 - 56	56 - 46
0.50 - 5.0	56	46
5.0 - 30.0	60	50

Note: 1. The lower limit shall apply at the transition frequencies.

2. The limit decreases in line with the logarithm of the frequency in the range of 0.15 to 0.50MHz.

### 4.2.2 Test Instruments

Description & Manufacturer	Model No.	Serial No.	Date Of Calibration	Due Date Of Calibration
Test Receiver ROHDE & SCHWARZ	ESCI	100613	Dec. 10, 2018	Dec. 09, 2019
RF signal cable (with 10dB PAD) Woken	5D-FB	Cable-cond1-01	Sep. 05, 2018	Sep. 04, 2019
LISN ROHDE & SCHWARZ (EUT)	ENV216	101826	Feb. 21, 2019	Feb. 20, 2020
LISN ROHDE & SCHWARZ (Peripheral)	ESH3-Z5	100311	Aug. 19, 2018	Aug. 18, 2019
Software ADT	BV ADT_Cond_ V7.3.7.4	NA	NA	NA

Note: 1. The calibration interval of the above test instruments is 12 months and the calibrations are traceable to NML/ROC and NIST/USA.

2. The test was performed in HwaYa Shielded Room 1.

3. The VCCI Site Registration No. is C-12040.

#### 4.2.3 Test Procedures

- The EUT was placed 0.4 meters from the conducting wall of the shielded room with EUT being connected to the power mains through a line impedance stabilization network (LISN). Other support units were connected to the power mains through another LISN. The two LISNs provide 50 ohm/ 50uH of coupling impedance for the measuring instrument.
- Both lines of the power mains connected to the EUT were checked for maximum conducted interference.
- The frequency range from 150kHz to 30MHz was searched. Emission levels under (Limit - 20dB) was not recorded.

NOTE: The resolution bandwidth and video bandwidth of test receiver is 9kHz for quasi-peak detection (QP) and average detection (AV) at frequency 0.15MHz-30MHz.

#### 4.2.4 Deviation from Test Standard

No deviation.

#### 4.2.5 Test Setup

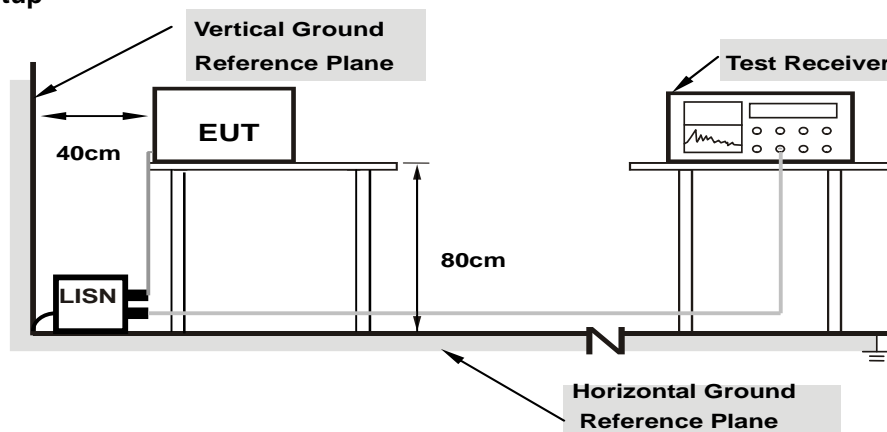

Note: 1.Support units were connected to second LISN.

For the actual test configuration, please refer to the attached file (Test Setup Photo).

#### 4.2.6 EUT Operating Conditions

Same as 4.1.6.

#### 4.2.7 Test Results

Phase	Line (L)	Detector Function	Quasi-Peak (QP) / Average (AV)
Test Mode	A		

No	Freq. [MHz]	Corr. Factor (dB)	Reading Value		Emission Level		Limit		Margin	
			[dB (uV)]		[dB (uV)]		[dB (uV)]		(dB)	
			Q.P.	AV.	Q.P.	AV.	Q.P.	AV.	Q.P.	AV.
1	0.17022	9.69	45.99	35.16	55.68	44.85	64.95	54.95	-9.27	-10.10
2	0.19728	9.68	39.89	24.09	49.57	33.77	63.72	53.72	-14.15	-19.95
<b>3</b>	<b>0.50600</b>	<b>9.68</b>	<b>37.99</b>	<b>33.37</b>	<b>47.67</b>	<b>43.05</b>	<b>56.00</b>	<b>46.00</b>	<b>-8.33</b>	<b>-2.95</b>
4	1.49400	9.68	22.65	21.24	32.33	30.92	56.00	46.00	-23.67	-15.08
5	2.99400	9.72	27.82	25.65	37.54	35.37	56.00	46.00	-18.46	-10.63
6	10.73400	9.88	21.91	19.45	31.79	29.33	60.00	50.00	-28.21	-20.67

#### REMARKS:

1. Q.P. and AV. are abbreviations of quasi-peak and average individually.
2. The emission levels of other frequencies were very low against the limit.
3. Margin value = Emission level - Limit value
4. Correction factor = Insertion loss + Cable loss
5. Emission Level = Correction Factor + Reading Value.

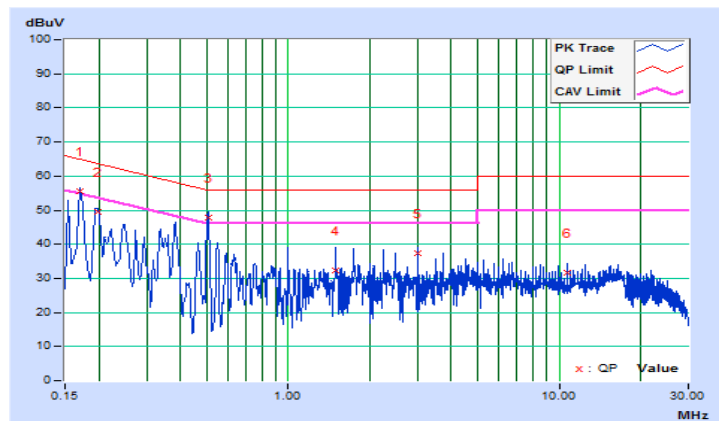

Phase	Neutral (N)	Detector Function	Quasi-Peak (QP) / Average (AV)
Test Mode	A		

No	Freq. [MHz]	Corr. Factor (dB)	Reading Value		Emission Level		Limit		Margin	
			[dB (uV)]		[dB (uV)]		[dB (uV)]		(dB)	
			Q.P.	AV.	Q.P.	AV.	Q.P.	AV.	Q.P.	AV.
1	0.15400	9.66	43.91	25.63	53.57	35.29	65.78	55.78	-12.21	-20.49
2	0.25400	9.66	35.15	28.65	44.81	38.31	61.63	51.63	-16.82	-13.32
3	0.50132	9.65	33.69	28.73	43.34	38.38	56.00	46.00	-12.66	-7.62
4	2.24600	9.68	28.94	27.17	38.62	36.85	56.00	46.00	-17.38	-9.15
5	3.74600	9.71	26.01	24.16	35.72	33.87	56.00	46.00	-20.28	-12.13
6	14.73000	9.93	22.35	18.59	32.28	28.52	60.00	50.00	-27.72	-21.48

REMARKS:

1. Q.P. and AV. are abbreviations of quasi-peak and average individually.
2. The emission levels of other frequencies were very low against the limit.
3. Margin value = Emission level - Limit value
4. Correction factor = Insertion loss + Cable loss
5. Emission Level = Correction Factor + Reading Value.

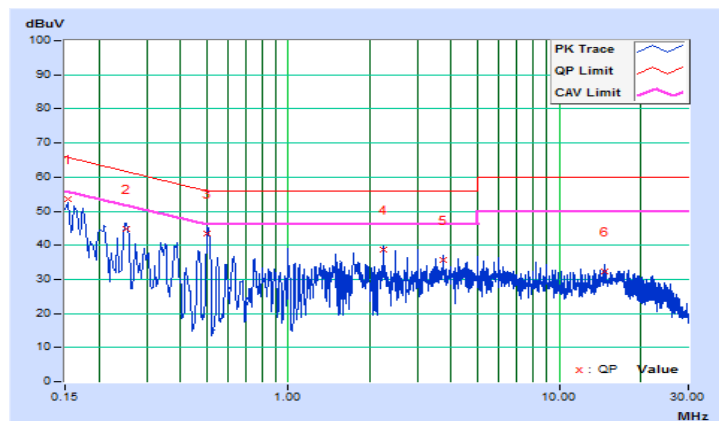

Phase	Line (L)	Detector Function	Quasi-Peak (QP) / Average (AV)
Test Mode	B		

No	Freq. [MHz]	Corr. Factor (dB)	Reading Value [dB (uV)]		Emission Level [dB (uV)]		Limit [dB (uV)]		Margin (dB)	
			Q.P.	AV.	Q.P.	AV.	Q.P.	AV.	Q.P.	AV.
			1	0.18228	9.68	47.23	39.71	56.91	49.39	64.38
2	0.23000	9.68	40.75	31.89	50.43	41.57	62.45	52.45	-12.02	-10.88
3	0.60603	9.68	29.12	16.98	38.80	26.66	56.00	46.00	-17.20	-19.34
4	1.05107	9.67	26.38	23.76	36.05	33.43	56.00	46.00	-19.95	-12.57
5	14.49000	9.90	22.96	17.18	32.86	27.08	60.00	50.00	-27.14	-22.92
6	23.48200	9.94	20.63	19.67	30.57	29.61	60.00	50.00	-29.43	-20.39

REMARKS:

1. Q.P. and AV. are abbreviations of quasi-peak and average individually.
2. The emission levels of other frequencies were very low against the limit.
3. Margin value = Emission level - Limit value
4. Correction factor = Insertion loss + Cable loss
5. Emission Level = Correction Factor + Reading Value.

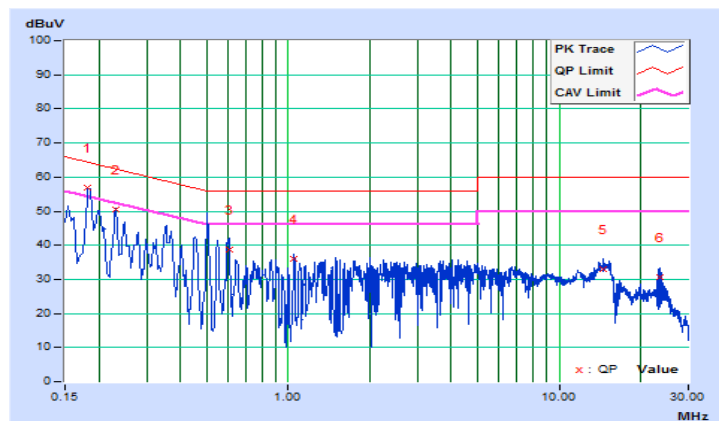



Phase	Neutral (N)	Detector Function	Quasi-Peak (QP) / Average (AV)
Test Mode	B		

No	Freq. [MHz]	Corr. Factor (dB)	Reading Value [dB (uV)]		Emission Level [dB (uV)]		Limit [dB (uV)]		Margin (dB)	
			Q.P.	AV.	Q.P.	AV.	Q.P.	AV.	Q.P.	AV.
			1	0.18600	9.66	42.92	34.43	52.58	44.09	64.21
2	0.36600	9.65	35.96	31.31	45.61	40.96	58.59	48.59	-12.98	-7.63
3	1.50200	9.66	27.71	21.04	37.37	30.70	56.00	46.00	-18.63	-15.30
4	4.00600	9.72	25.74	14.19	35.46	23.91	56.00	46.00	-20.54	-22.09
5	15.23400	9.93	25.25	19.59	35.18	29.52	60.00	50.00	-24.82	-20.48
6	23.22600	10.01	20.14	19.28	30.15	29.29	60.00	50.00	-29.85	-20.71

REMARKS:

1. Q.P. and AV. are abbreviations of quasi-peak and average individually.
2. The emission levels of other frequencies were very low against the limit.
3. Margin value = Emission level - Limit value
4. Correction factor = Insertion loss + Cable loss
5. Emission Level = Correction Factor + Reading Value.

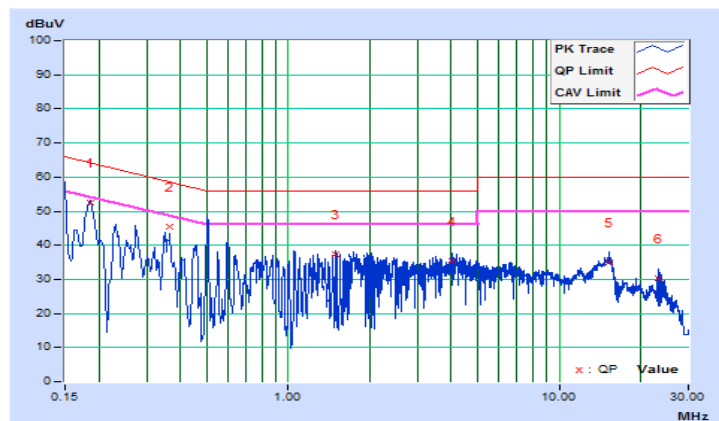

### 4.3 Transmit Power Measurement

#### 4.3.1 Limits of Transmit Power Measurement

Operation Band	EUT Category		LIMIT
U-NII-1		Outdoor Access Point	1 Watt (30 dBm) (Max. e.i.r.p $\leq$ 125mW(21 dBm) at any elevation angle above 30 degrees as measured from the horizon)
		Fixed point-to-point Access Point	1 Watt (30 dBm)
	√	Indoor Access Point	1 Watt (30 dBm)
		Mobile and Portable client device	250mW (24 dBm)
U-NII-2A	-		250mW (24 dBm) or 11 dBm+10 log B*
U-NII-2C	-		250mW (24 dBm) or 11 dBm+10 log B*
U-NII-3	√		1 Watt (30 dBm)

\*B is the 26 dB emission bandwidth in megahertz

Per KDB 662911 Method of conducted output power measurement on IEEE 802.11 devices,

Array Gain = 0 dB (i.e., no array gain) for  $N_{ANT} \leq 4$ ;

Array Gain = 0 dB (i.e., no array gain) for channel widths  $\geq 40$  MHz for any  $N_{ANT}$ ;

Array Gain =  $5 \log(N_{ANT}/N_{SS})$  dB or 3 dB, whichever is less for 20-MHz channel widths with  $N_{ANT} \geq 5$ .

For power measurements on all other devices: Array Gain =  $10 \log(N_{ANT}/N_{SS})$  dB.

#### 4.3.2 Test Setup

For Power Output

802.11a, 802.11n (HT20), 802.11n (HT40)

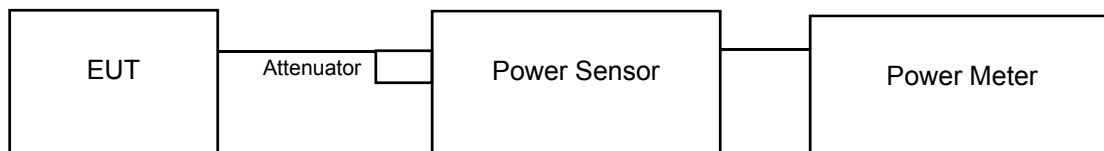

802.11ac (VHT80)

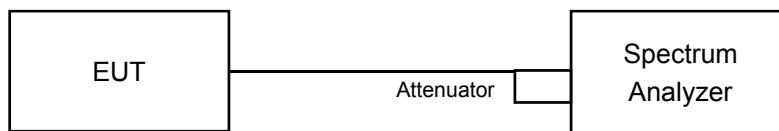

For 26dB Bandwidth

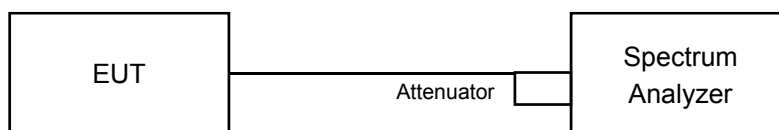

### 4.3.3 Test Instruments

Refer to section 4.1.2 to get information of above instrument.

### 4.3.4 Test Procedure

#### For Average Power Measurement

#### For 802.11a, 802.11n (HT20), 802.11n (HT40)

Method PM is used to perform output power measurement, trigger and gating function of wide band power meter is enabled to measure max output power of TX on burst. Duty factor is not added to measured value.

#### For 802.11ac (VHT80), 802.11ac (VHT80+VHT80)

- a. Set span to encompass the entire 26 dB EBW (or, alternatively, the entire 99% occupied bandwidth) of the signal.
- b. Set sweep trigger to "free run".
- c. Set RBW = 1 MHz
- d. Set VBW  $\geq$  3 MHz
- e. Number of points in sweep  $\geq$  2 Span / RBW
- f. Sweep time  $\leq$  (number of points in sweep) \* T
- g. Using emission bandwidth to determine the frequency span for integration the channel bandwidth.
- h. Detector = RMS
- i. Trace mode = max hold
- j. Allow max hold to run for at least 60 seconds, or longer as needed to allow the trace to stabilize.
- k. Compute power by integrating the spectrum across the EBW (or, alternatively, the entire 99% occupied bandwidth) of the signal using the instrument's band power measurement function with band limits set equal to the EBW (or occupied bandwidth) band edges. If the instrument does not have a band power function, sum the spectrum levels (in power units) at 1 MHz intervals extending across the EBW (or, alternatively, the entire 99% occupied bandwidth) of the spectrum.

#### For 26dB Bandwidth

- a. Set RBW = approximately 1% of the emission bandwidth.
- b. Set the VBW > RBW.
- c. Detector = Peak.
- d. Trace mode = max hold.
- e. Measure the maximum width of the emission that is 26 dB down from the peak of the emission. Compare this with the RBW setting of the analyzer. Readjust RBW and repeat measurement as needed until the RBW/EBW ratio is approximately 1%.

### 4.3.5 Deviation from Test Standard

No deviation.

### 4.3.6 EUT Operating Conditions

The software provided by client to enable the EUT under transmission condition continuously at lowest, middle and highest channel frequencies individually.

#### 4.3.7 Test Result

Power Output:

CDD Mode

##### 802.11a

Channel	Frequency (MHz)	Maximum Conducted Power (dBm)				Total Power (mW)	Total Power (dBm)	Power Limit (dBm)	Pass / Fail
		Chain 0	Chain 1	Chain 2	Chain 3				
36	5180	20.51	21.37	20.04	20.89	473.217	26.75	30	Pass
40	5200	22.23	22.81	21.77	22.78	698.079	28.44	30	Pass
48	5240	21.23	21.75	20.67	21.19	530.566	27.25	30	Pass
149	5745	24.03	24.25	23.45	24.11	<b>997.944</b>	29.99	30	Pass
157	5785	23.99	24.34	23.44	24.03	995.985	29.98	30	Pass
165	5825	18.58	19.00	17.89	18.53	284.347	24.54	30	Pass

##### 802.11n (HT20)

Channel	Frequency (MHz)	Maximum Conducted Power (dBm)				Total Power (mW)	Total Power (dBm)	Power Limit (dBm)	Pass / Fail
		Chain 0	Chain 1	Chain 2	Chain 3				
36	5180	19.72	20.55	19.26	20.04	392.515	25.94	30	Pass
40	5200	22.26	23.14	21.93	22.91	725.719	28.61	30	Pass
48	5240	22.35	22.90	21.74	22.30	685.878	28.36	30	Pass
149	5745	23.81	23.75	22.95	23.45	896.124	29.52	30	Pass
157	5785	23.65	23.91	22.73	23.35	881.547	29.45	30	Pass
165	5825	19.11	19.45	18.27	19.03	316.701	25.01	30	Pass

##### 802.11n (HT40)

Channel	Frequency (MHz)	Maximum Conducted Power (dBm)				Total Power (mW)	Total Power (dBm)	Power Limit (dBm)	Pass / Fail
		Chain 0	Chain 1	Chain 2	Chain 3				
38	5190	19.95	20.78	19.35	20.32	412.275	26.15	30	Pass
46	5230	22.97	23.86	22.23	23.38	<b>826.253</b>	29.17	30	Pass
151	5755	23.61	23.77	22.82	23.55	885.737	29.47	30	Pass
159	5795	23.45	23.78	22.79	23.53	875.622	29.42	30	Pass

##### 802.11ac (VHT80)

Channel	Frequency (MHz)	Maximum Conducted Power (dBm)				Total Power (mW)	Total Power (dBm)	Power Limit (dBm)	Pass / Fail
		Chain 0	Chain 1	Chain 2	Chain 3				
42	5210	19.66	20.25	19.11	20.08	381.724	25.82	30	Pass
155	5775	20.22	20.75	19.69	20.66	433.570	26.37	30	Pass

### 802.11ac (VHT80+VHT80)

Channel	Frequency (MHz)	Maximum Conducted Power (dBm)				Total Power (mW)	Total Power (dBm)	Power Limit (dBm)	Pass / Fail
		Chain 0	Chain 1	Chain 2	Chain 3				
42	5210	19.46	20.05	-	-	189.466	22.78	30	Pass
155	5775	-	-	18.22	19.05	146.727	21.67	30	Pass

### Beamforming Mode

#### 802.11n (HT20)

Channel	Frequency (MHz)	Maximum Conducted Power (dBm)				Total Power (mW)	Total Power (dBm)	Power Limit (dBm)	Pass / Fail
		Chain 0	Chain 1	Chain 2	Chain 3				
36	5180	13.70	14.53	13.24	14.02	98.142	19.92	27.88	Pass
40	5200	16.24	17.12	15.91	16.89	181.455	22.59	27.88	Pass
48	5240	16.33	16.88	15.72	16.28	171.494	22.34	27.88	Pass
149	5745	17.79	17.73	16.93	17.43	224.062	23.50	27.88	Pass
157	5785	17.63	17.89	16.71	17.33	220.417	23.43	27.88	Pass
165	5825	13.09	13.43	12.25	13.01	79.186	18.99	27.88	Pass

\*Directional Gain =  $2.1\text{dBi} + 10\log(4) = 8.12\text{dBi} > 6\text{dBi}$ , so the limit shall be reduced to  $30 - (8.12 - 6) = 27.88\text{dBm}$ .

#### 802.11n (HT40)

Channel	Frequency (MHz)	Maximum Conducted Power (dBm)				Total Power (mW)	Total Power (dBm)	Power Limit (dBm)	Pass / Fail
		Chain 0	Chain 1	Chain 2	Chain 3				
38	5190	13.93	14.76	13.33	14.30	103.083	20.13	27.88	Pass
46	5230	16.95	17.84	16.21	17.36	206.592	23.15	27.88	Pass
151	5755	17.59	17.75	16.80	17.53	221.465	23.45	27.88	Pass
159	5795	17.43	17.76	16.77	17.51	218.937	23.40	27.88	Pass

\*Directional Gain =  $2.1\text{dBi} + 10\log(4) = 8.12\text{dBi} > 6\text{dBi}$ , so the limit shall be reduced to  $30 - (8.12 - 6) = 27.88\text{dBm}$ .

### 802.11ac (VHT80)

Channel	Frequency (MHz)	Maximum Conducted Power (dBm)				Total Power (mW)	Total Power (dBm)	Power Limit (dBm)	Pass / Fail
		Chain 0	Chain 1	Chain 2	Chain 3				
42	5210	13.64	14.23	13.09	14.06	95.444	19.80	27.88	Pass
155	5775	14.20	14.73	13.67	14.64	108.408	20.35	27.88	Pass

\*Directional Gain =  $2.1\text{dBi} + 10\log(4) = 8.12\text{dBi} > 6\text{dBi}$ , so the limit shall be reduced to  $30 - (8.12 - 6) = 27.88\text{dBm}$ .

### 802.11ac (VHT80+VHT80)

Channel	Frequency (MHz)	Maximum Conducted Power (dBm)				Total Power (mW)	Total Power (dBm)	Power Limit (dBm)	Pass / Fail
		Chain 0	Chain 1	Chain 2	Chain 3				
42	5210	16.45	17.04	-	-	94.739	19.77	30.00	Pass
155	5775	-	-	15.21	16.04	73.368	18.66	30.00	Pass

\*Directional Gain =  $2.1\text{dBi} + 10\log(2) = 5.11\text{dBi} < 6\text{dBi}$ , so the limit no need to reduce.

26dB Bandwidth:

802.11a

Channel	Frequency (MHz)	26dBc Bandwidth (MHz)			
		Chain 0	Chain 1	Chain 2	Chain 3
36	5180	20.20	20.44	19.80	20.05
40	5200	20.39	20.35	19.80	20.26
48	5240	20.20	19.81	19.79	20.29

802.11n (HT20)

Channel	Frequency (MHz)	26dBc Bandwidth (MHz)			
		Chain 0	Chain 1	Chain 2	Chain 3
36	5180	20.64	20.94	20.66	20.65
40	5200	20.86	20.96	20.82	20.95
48	5240	20.75	20.59	20.90	20.78

802.11n (HT40)

Channel	Frequency (MHz)	26dBc Bandwidth (MHz)			
		Chain 0	Chain 1	Chain 2	Chain 3
38	5190	40.71	40.77	40.58	40.48
46	5230	40.95	41.05	40.69	40.91

802.11ac (VHT80)

Channel	Frequency (MHz)	26dBc Bandwidth (MHz)			
		Chain 0	Chain 1	Chain 2	Chain 3
42	5210	83.92	83.68	83.98	83.13

802.11ac (VHT80+VHT80)

Channel	Frequency (MHz)	26dBc Bandwidth (MHz)	
		Chain 0	Chain 1
42	5210	83.80	83.43

### Spectrum Plot of Worst Value

#### 802.11a

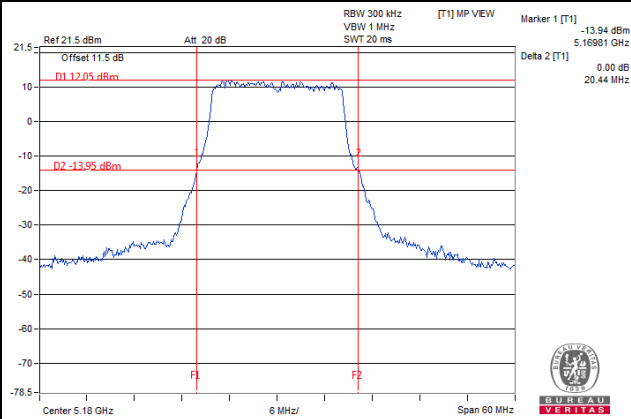

#### 802.11n (HT20)

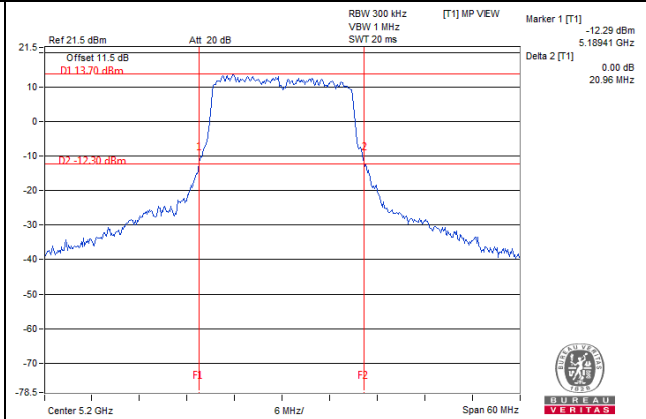

#### 802.11n (HT40)

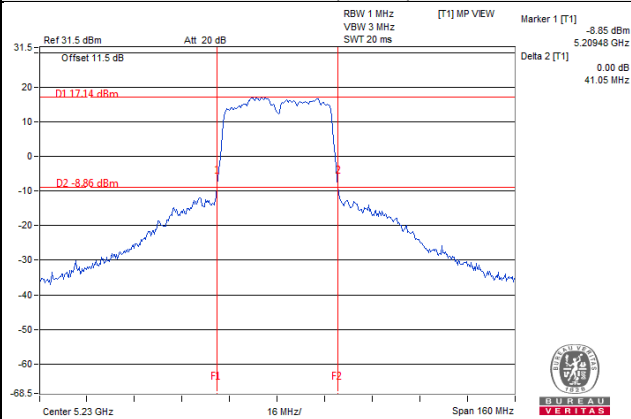

#### 802.11ac (VHT80)

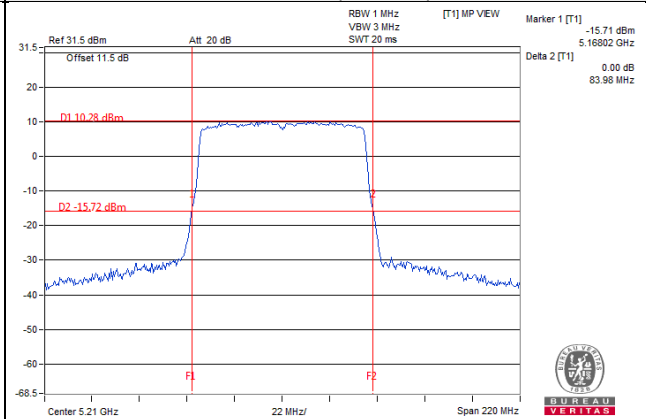

#### 802.11ac (VHT80+VHT80)

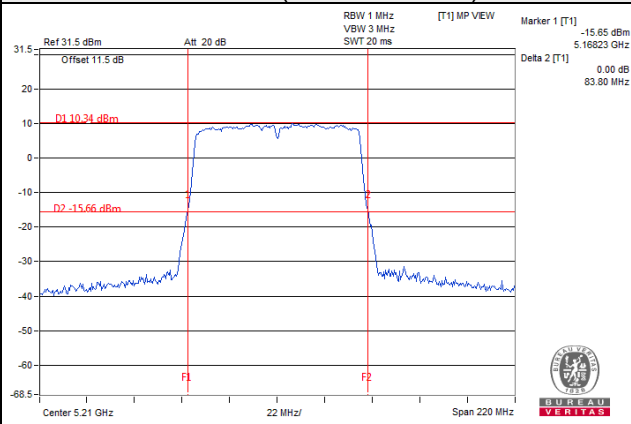



## 4.4 Occupied Bandwidth Measurement

### 4.4.1 Test Setup

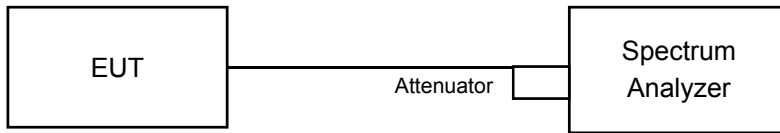

### 4.4.2 Test Instruments

Refer to section 4.1.2 to get information of above instrument.

### 4.4.3 Test Procedure

The transmitter output was connected to the spectrum analyzer through an attenuator. The bandwidth of the fundamental frequency was measured by spectrum analyzer with resolution bandwidth in the range of 1% to 5% of the anticipated emission bandwidth, and a video bandwidth at least 3x the resolution bandwidth and set the detector to sampling. The width of a frequency band such that, below the lower and above the upper frequency limits, the mean powers emitted are each equal to a specified percentage 0.5 %of the total mean power of a given emission.

#### 4.4.4 Test Result

##### Occupied Bandwidth:

##### 802.11a

Channel	Frequency (MHz)	Occupied Bandwidth (MHz)			
		Chain 0	Chain 1	Chain 2	Chain 3
36	5180	16.56	16.56	16.44	16.56
40	5200	16.56	16.56	16.56	16.56
48	5240	16.56	16.44	16.56	16.56
149	5745	16.56	16.56	16.44	16.56
157	5785	16.56	16.56	16.56	16.56
165	5825	16.56	16.56	16.44	16.56

##### 802.11n (HT20)

Channel	Frequency (MHz)	Occupied Bandwidth (MHz)			
		Chain 0	Chain 1	Chain 2	Chain 3
36	5180	17.76	17.76	17.64	17.64
40	5200	17.64	17.64	17.64	17.64
48	5240	17.64	17.64	17.64	17.64
149	5745	17.64	17.76	17.64	17.64
157	5785	17.76	17.76	17.64	17.76
165	5825	17.64	17.64	17.64	17.76

##### 802.11n (HT40)

Channel	Frequency (MHz)	Occupied Bandwidth (MHz)			
		Chain 0	Chain 1	Chain 2	Chain 3
38	5190	36.12	36.00	36.00	36.12
46	5230	36.12	36.12	36.00	36.12
151	5755	36.12	36.00	36.12	36.00
159	5795	36.12	36.00	36.12	36.00

##### 802.11ac (VHT80)

Channel	Frequency (MHz)	Occupied Bandwidth (MHz)			
		Chain 0	Chain 1	Chain 2	Chain 3
42	5210	75.84	75.84	75.84	75.84
155	5775	75.84	75.60	75.84	75.60

### 802.11ac (VHT80+VHT80)

Channel	Frequency (MHz)	Occupied Bandwidth (MHz)			
		Chain 0	Chain 1	Chain 2	Chain 3
42	5210	76.32	76.08	-	-
155	5775	-	-	76.00	75.65

### Spectrum Plot of Worst Value

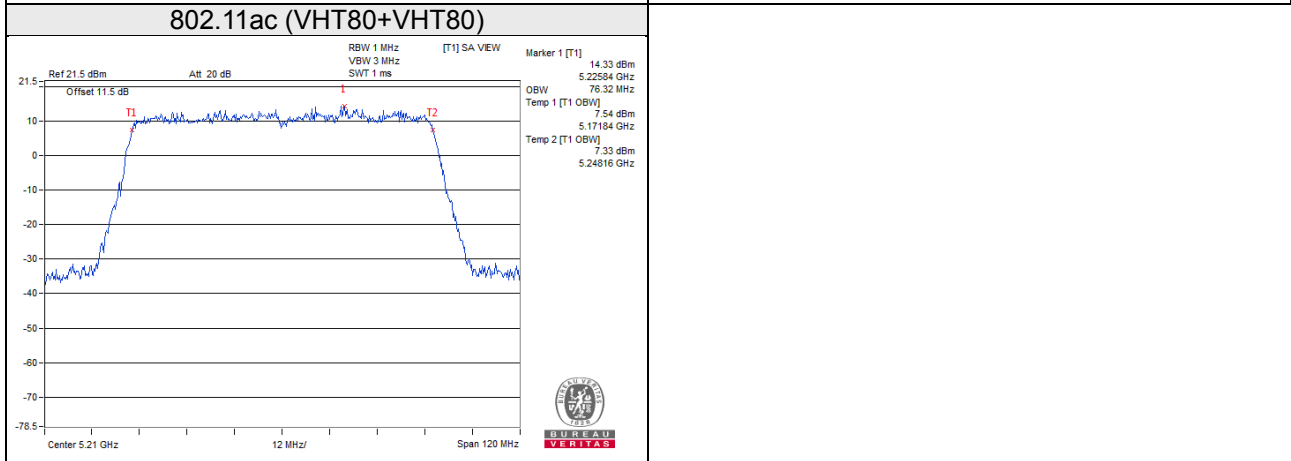
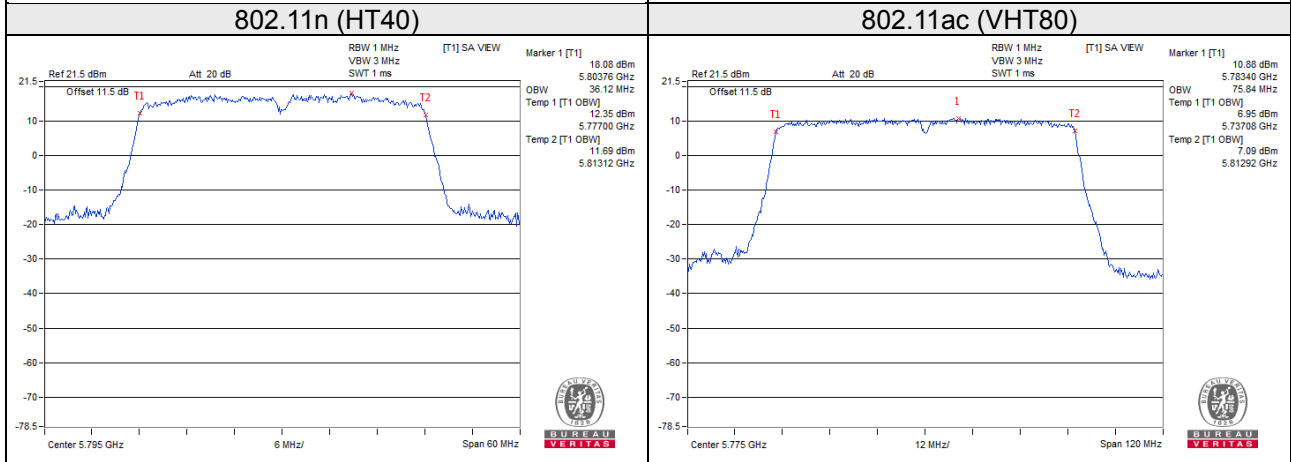
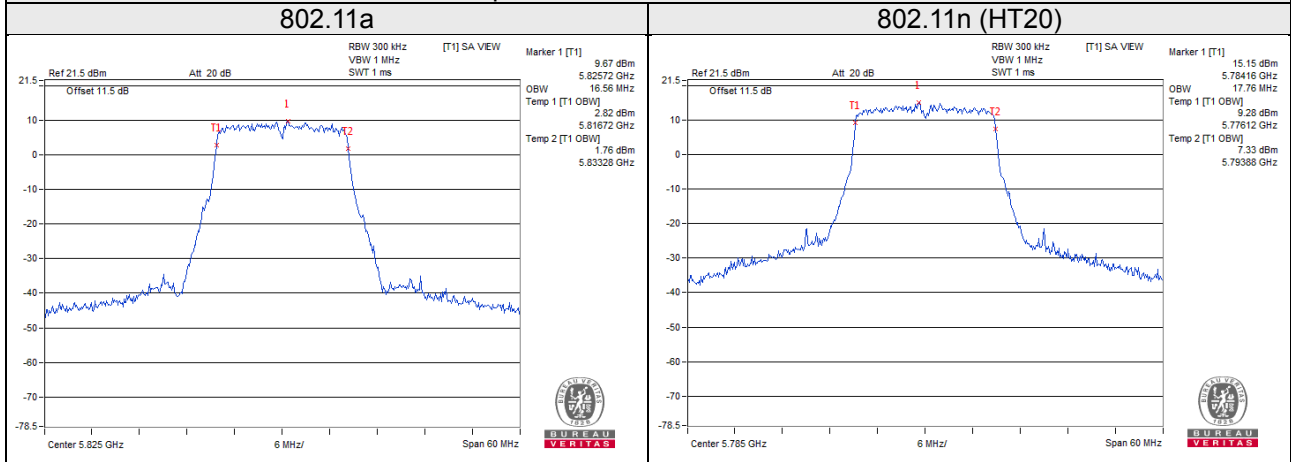

## 4.5 Peak Power Spectral Density Measurement

### 4.5.1 Limits of Peak Power Spectral Density Measurement

Operation Band	EUT Category		LIMIT
U-NII-1		Outdoor Access Point	17dBm/ MHz
		Fixed point-to-point Access Point	
	√	Indoor Access Point	
		Mobile and Portable client device	11dBm/ MHz
U-NII-2A	-		11dBm/ MHz
U-NII-2C	-		11dBm/ MHz
U-NII-3	√		30dBm/ 500kHz

### 4.5.2 Test Setup

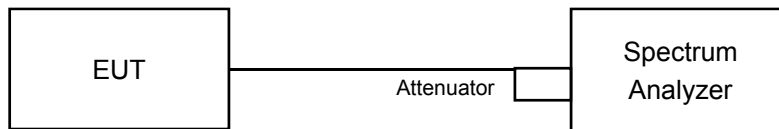

### 4.5.3 Test Instruments

Refer to section 4.1.2 to get information of above instrument.

#### 4.5.4 Test Procedures

##### For U-NII-1band:

Duty cycle of test signal is  $\geq 98\%$

Using method SA-1

- 1) Set span to encompass the entire emission bandwidth (EBW) of the signal.
- 2) Set RBW = 1MHz, Set VBW  $\geq 3$  MHz, Detector = RMS
- 3) Set Channel power measure = 1MHz
- 4) Sweep time = auto, trigger set to "free run".
- 5) Trace average at least 100 traces in power averaging mode.
- 6) Record the max value

Using method SA-2, Duty cycle  $<98\%$

- 1) Set span to encompass the entire emission bandwidth (EBW) of the signal.
- 2) Set RBW = 30 kHz, Set VBW  $\geq 1$  MHz, Detector = RMS
- 3) Set Channel power measure = 1MHz
- 4) Sweep time = auto, trigger set to "free run".
- 5) Trace average at least 100 traces in power averaging mode.
- 6) Record the max value and add  $10 \log (1/\text{duty cycle})$

##### For U-NII-3 band:

Duty cycle of test signal is  $\geq 98\%$

- 1) Set span to encompass the entire emission bandwidth (EBW) of the signal.
- 2) Set RBW = 300 kHz, Set VBW  $\geq 1$  MHz, Detector = RMS.
- 3) Use the peak marker function to determine the maximum power level in any 300 kHz band segment within the fundamental EBW.
- 4) Scale the observed power level to an equivalent value in 500 kHz by adjusting (reducing) the measured power by a bandwidth correction factor (BWCF) where  $\text{BWCF} = 10\log(500 \text{ kHz} / 300 \text{ kHz})$ .
- 5) Sweep time = auto, trigger set to "free run".
- 6) Trace average at least 100 traces in power averaging mode.
- 7) Record the max value.

Duty cycle  $<98\%$

- 1) Set span to encompass the entire emission bandwidth (EBW) of the signal.
- 2) Set RBW = 300 kHz, Set VBW  $\geq 1$  MHz, Detector = RMS
- 3) Use the peak marker function to determine the maximum power level in any 300 kHz band segment within the fundamental EBW.
- 4) Scale the observed power level to an equivalent value in 500 kHz by adjusting (reducing) the measured power by a bandwidth correction factor (BWCF) where  $\text{BWCF} = 10\log(500 \text{ kHz}/300\text{kHz})$
- 5) Sweep time = auto, trigger set to "free run".
- 6) Trace average at least 100 traces in power averaging mode.
- 7) Record the max value and add  $10 \log (1/\text{duty cycle})$

#### 4.5.5 Deviation from Test Standard

No deviation.

#### 4.5.6 EUT Operating Conditions

Same as 4.3.6.

#### 4.5.7 Test Results

##### For U-NII-1 Band

##### 802.11a

Chan.	Freq. (MHz)	PSD (dBm)				Duty factor	Total PSD with duty factor (dBm)	Max. Limit (dBm)	Pass / Fail
		Chain 0	Chain 1	Chain 2	Chain 3				
36	5180	6.75	6.96	6.01	6.72	0.18	12.82	14.88	Pass
40	5200	8.14	8.05	7.60	8.58	0.18	14.31	14.88	Pass
48	5240	8.25	7.40	7.76	8.44	0.18	14.18	14.88	Pass

Note:

1. Method 1 of power density measurement of KDB 662911 is using for calculating total power density. Total power density is summing entire spectra across corresponding frequency bins on the various outputs by computer.
2. Directional Gain = 2.1dBi + 10log(4)= 8.12dBi > 6dBi, so the limit shall be reduced to 17-(8.12-6) = 14.88dBm.
3. Refer to section 3.3 for duty cycle spectrum plot.

##### 802.11n (HT20)

Chan.	Freq. (MHz)	PSD (dBm)				Total PSD (dBm)	Max. Limit (dBm)	Pass / Fail
		Chain 0	Chain 1	Chain 2	Chain 3			
36	5180	5.72	5.62	5.23	5.84	11.63	14.88	Pass
40	5200	8.34	8.35	7.62	8.31	14.19	14.88	Pass
48	5240	8.16	8.74	7.57	8.15	14.20	14.88	Pass

Note:

1. Method 1 of power density measurement of KDB 662911 is using for calculating total power density. Total power density is summing entire spectra across corresponding frequency bins on the various outputs by computer.
2. Directional Gain = 2.1dBi + 10log(4)= 8.12dBi > 6dBi, so the limit shall be reduced to 17-(8.12-6) = 14.88dBm.

##### 802.11n (HT40)

Chan.	Freq. (MHz)	PSD (dBm)				Duty factor	Total PSD with duty factor (dBm)	Max. Limit (dBm)	Pass / Fail
		Chain 0	Chain 1	Chain 2	Chain 3				
38	5190	2.76	3.98	2.57	3.04	0.14	9.28	14.88	Pass
46	5230	5.91	6.97	5.46	6.10	0.14	12.31	14.88	Pass

Note:

1. Method 1 of power density measurement of KDB 662911 is using for calculating total power density. Total power density is summing entire spectra across corresponding frequency bins on the various outputs by computer.
2. Directional Gain = 2.1dBi + 10log(4)= 8.12dBi > 6dBi, so the limit shall be reduced to 17-(8.12-6) = 14.88dBm.
3. Refer to section 3.3 for duty cycle spectrum plot.

### 802.11ac (VHT80)

Chan.	Freq. (MHz)	PSD (dBm)				Duty factor	Total PSD with duty factor (dBm)	Max. Limit (dBm)	Pass / Fail
		Chain 0	Chain 1	Chain 2	Chain 3				
42	5210	-0.89	0.06	-0.39	-0.77	0.28	5.82	14.88	Pass

Note:

1. Method 1 of power density measurement of KDB 662911 is using for calculating total power density. Total power density is summing entire spectra across corresponding frequency bins on the various outputs by computer.
2. Directional Gain =  $2.1\text{dBi} + 10\log(4) = 8.12\text{dBi} > 6\text{dBi}$ , so the limit shall be reduced to  $17 - (8.12 - 6) = 14.88\text{dBm}$ .
3. Refer to section 3.3 for duty cycle spectrum plot.

### 802.11ac (VHT80+VHT80)

Chan.	Freq. (MHz)	PSD (dBm)		Duty factor	Total PSD with duty factor (dBm)	Max. Limit (dBm)	Pass / Fail
		Chain 0	Chain 1				
42	5210	-0.67	1.00	0.28	3.53	17.00	Pass

Note:

1. Method 1 of power density measurement of KDB 662911 is using for calculating total power density. Total power density is summing entire spectra across corresponding frequency bins on the various outputs by computer.
2. Directional Gain =  $2.1\text{dBi} + 10\log(2) = 5.11\text{dBi} < 6\text{dBi}$ , so the limit no need to reduce.
3. Refer to section 3.3 for duty cycle spectrum plot.

### Spectrum Plot of Worst Value

**802.11a / Ch 40 / Chain 3**

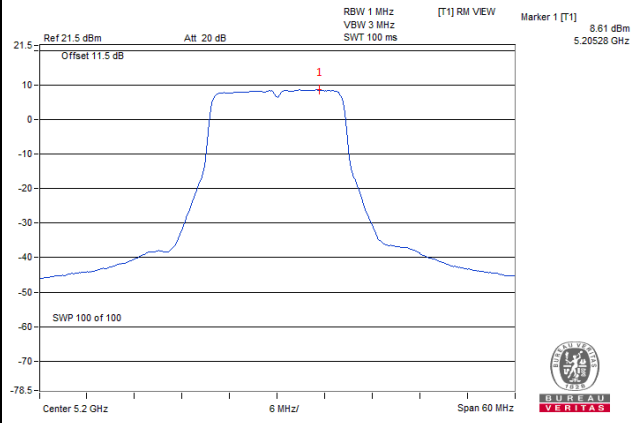

**802.11n (HT20) / Ch 48 / Chain 1**

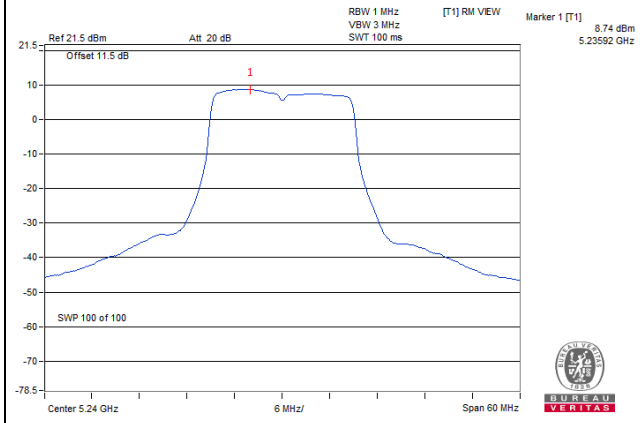

**802.11n (HT40) / Ch 46 / Chain 1**

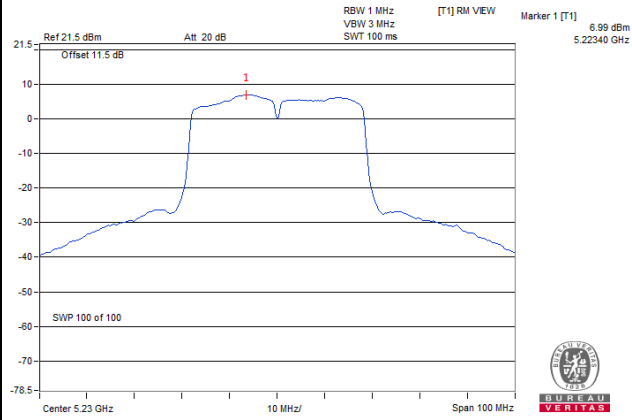

**802.11ac (VHT80) / Ch 42 / Chain 1**

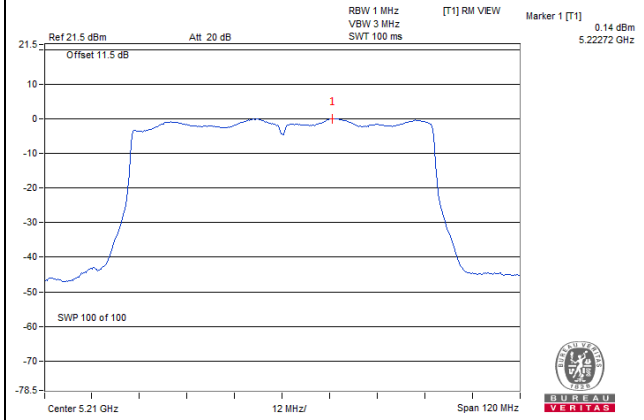

**802.11ac (VHT80+VHT80) / Ch 42 / Chain 1**

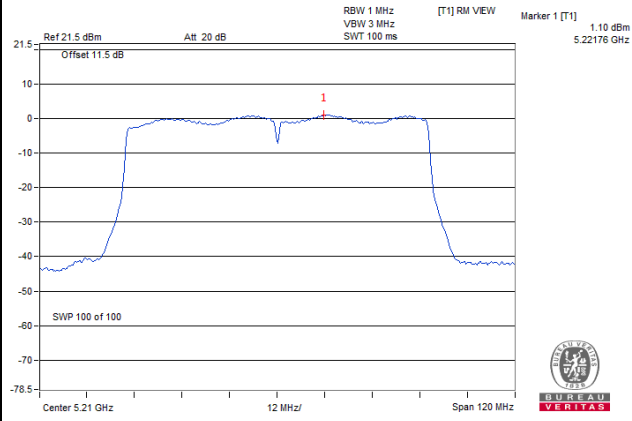



For U-NII-3 Band

802.11a

TX chain	Channel	Freq. (MHz)	PSD (dBm/300kHz)	PSD (dBm/500kHz)	10 log (N=4) dB	Duty factor	Total PSD (dBm/500kHz)	Limit (dBm/500kHz)	Pass / Fail
0	149	5745	2.17	4.39	6.02	0.18	10.59	27.88	Pass
	157	5785	2.51	4.73	6.02	0.18	10.93	27.88	Pass
	165	5825	-2.85	-0.63	6.02	0.18	5.57	27.88	Pass
1	149	5745	3.08	5.30	6.02	0.18	11.50	27.88	Pass
	157	5785	3.01	5.23	6.02	0.18	11.43	27.88	Pass
	165	5825	-2.86	-0.64	6.02	0.18	5.56	27.88	Pass
2	149	5745	2.51	4.73	6.02	0.18	10.93	27.88	Pass
	157	5785	2.34	4.56	6.02	0.18	10.76	27.88	Pass
	165	5825	-3.40	-1.18	6.02	0.18	5.02	27.88	Pass
3	149	5745	2.30	4.52	6.02	0.18	10.72	27.88	Pass
	157	5785	2.27	4.49	6.02	0.18	10.69	27.88	Pass
	165	5825	-2.99	-0.77	6.02	0.18	5.43	27.88	Pass

Note:

1. Method 1 of power density measurement of KDB 662911 is using for calculating total power density. Total power density is summing entire spectra across corresponding frequency bins on the various outputs by computer.
2. Directional Gain = 2.1dBi + 10log(4)= 8.12dBi > 6dBi, so the limit shall be reduced to 30-(8.12-6) = 27.88dBm.
3. Refer to section 3.3 for duty cycle spectrum plot.

### 802.11n (HT20)

TX chain	Channel	Freq. (MHz)	PSD (dBm/300kHz)	PSD (dBm/500kHz)	10 log (N=4) dB	Total PSD (dBm/500kHz)	Limit (dBm/500kHz)	Pass / Fail
0	149	5745	1.93	4.15	6.02	10.17	27.88	Pass
	157	5785	1.83	4.05	6.02	10.07	27.88	Pass
	165	5825	-2.59	-0.37	6.02	5.65	27.88	Pass
1	149	5745	2.66	4.88	6.02	10.90	27.88	Pass
	157	5785	2.73	4.95	6.02	10.97	27.88	Pass
	165	5825	-2.19	0.03	6.02	6.05	27.88	Pass
2	149	5745	1.31	3.53	6.02	9.55	27.88	Pass
	157	5785	1.33	3.55	6.02	9.57	27.88	Pass
	165	5825	-2.84	-0.62	6.02	5.40	27.88	Pass
3	149	5745	2.31	4.53	6.02	10.55	27.88	Pass
	157	5785	2.19	4.41	6.02	10.43	27.88	Pass
	165	5825	-2.17	0.05	6.02	6.07	27.88	Pass

Note:

- Method 1 of power density measurement of KDB 662911 is using for calculating total power density. Total power density is summing entire spectra across corresponding frequency bins on the various outputs by computer.
- Directional Gain =  $2.1\text{dBi} + 10\log(4) = 8.12\text{dBi} > 6\text{dBi}$ , so the limit shall be reduced to  $30 - (8.12 - 6) = 27.88\text{dBm}$ .
- Refer to section 3.3 for duty cycle spectrum plot.

### 802.11n (HT40)

TX chain	Channel	Freq. (MHz)	PSD (dBm/300kHz)	PSD (dBm/500kHz)	10 log (N=4) dB	Duty factor	Total PSD (dBm/500kHz)	Limit (dBm/500kHz)	Pass / Fail
0	151	5755	-1.10	1.12	6.02	0.14	7.28	27.88	Pass
	159	5795	-1.36	0.86	6.02	0.14	7.02	27.88	Pass
1	151	5755	-0.33	1.89	6.02	0.14	8.05	27.88	Pass
	159	5795	-0.58	1.64	6.02	0.14	7.80	27.88	Pass
2	151	5755	-1.48	0.74	6.02	0.14	6.90	27.88	Pass
	159	5795	-1.54	0.68	6.02	0.14	6.84	27.88	Pass
3	151	5755	-0.94	1.28	6.02	0.14	7.44	27.88	Pass
	159	5795	-1.11	1.11	6.02	0.14	7.27	27.88	Pass

Note:

- Method 1 of power density measurement of KDB 662911 is using for calculating total power density. Total power density is summing entire spectra across corresponding frequency bins on the various outputs by computer.
- Directional Gain =  $2.1\text{dBi} + 10\log(4) = 8.12\text{dBi} > 6\text{dBi}$ , so the limit shall be reduced to  $30 - (8.12 - 6) = 27.88\text{dBm}$ .
- Refer to section 3.3 for duty cycle spectrum plot.

### 802.11ac (VHT80)

TX chain	Channel	Freq. (MHz)	PSD (dBm/300kHz)	PSD (dBm/500kHz)	10 log (N=4) dB	Duty factor	Total PSD (dBm/500kHz)	Limit (dBm/500kHz)	Pass / Fail
0	155	5775	-8.04	-5.82	6.02	0.28	0.48	27.88	Pass
1	155	5775	-7.08	-4.86	6.02	0.28	1.44	27.88	Pass
2	155	5775	-8.03	-5.81	6.02	0.28	0.49	27.88	Pass
3	155	5775	-7.48	-5.26	6.02	0.28	1.04	27.88	Pass

Note:

1. Method 1 of power density measurement of KDB 662911 is using for calculating total power density. Total power density is summing entire spectra across corresponding frequency bins on the various outputs by computer.
2. Directional Gain =  $2.1\text{dBi} + 10\log(4) = 8.12\text{dBi} > 6\text{dBi}$ , so the limit shall be reduced to  $30 - (8.12 - 6) = 27.88\text{dBm}$ .
3. Refer to section 3.3 for duty cycle spectrum plot.

### 802.11ac (VHT80+VHT80)

TX chain	Channel	Freq. (MHz)	PSD (dBm/300kHz)	PSD (dBm/500kHz)	10 log (N=2) dB	Duty factor	Total PSD (dBm/500kHz)	Limit (dBm/500kHz)	Pass / Fail
2	155	5775	-9.49	-7.27	3.01	0.28	-3.98	30.00	Pass
3	155	5775	-8.12	-5.90	3.01	0.28	-2.61	30.00	Pass

Note:

1. Method 1 of power density measurement of KDB 662911 is using for calculating total power density. Total power density is summing entire spectra across corresponding frequency bins on the various outputs by computer.
2. Directional Gain =  $2.1\text{dBi} + 10\log(2) = 5.11\text{dBi} < 6\text{dBi}$ , so the limit no need to reduce.
3. Refer to section 3.3 for duty cycle spectrum plot.

### Spectrum Plot of Worst Value

#### 802.11a

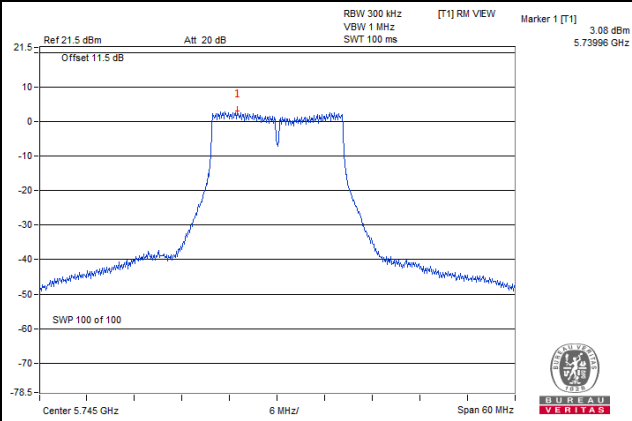

#### 802.11n (HT20)

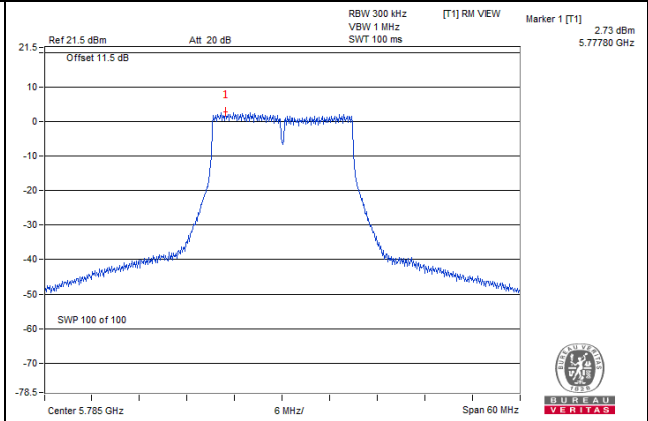

#### 802.11n (HT40)

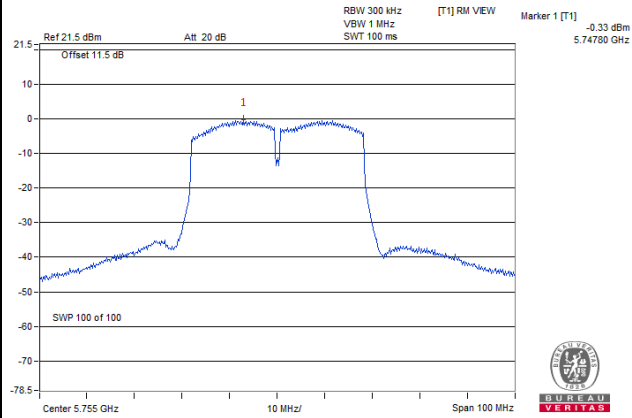

#### 802.11ac (VHT80)

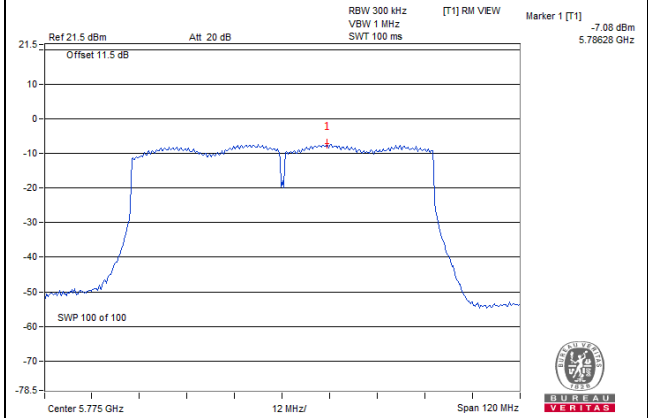

#### 802.11ac (VHT80+VHT80)

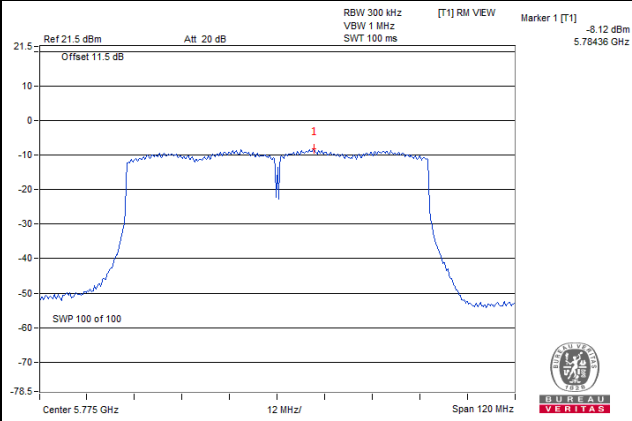

## 4.6 Frequency Stability

### 4.6.1 Limits of Frequency Stability Measurement

The frequency of the carrier signal shall be maintained within band of operation

### 4.6.2 Test Setup

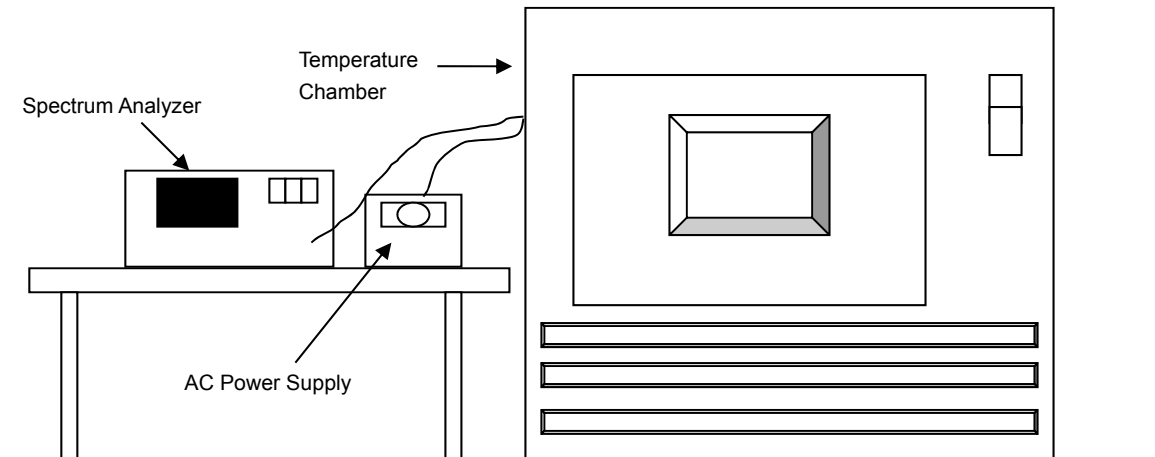

### 4.6.3 Test Instruments

Description & Manufacturer	Model No.	Serial No.	Cal. Date	Cal. Due
Spectrum Analyzer ROHDE & SCHWARZ	FSP40	100040	Sep. 25, 2018	Sep. 24, 2019
Temperature & Humidity chamber TERCHY	MHU-225AU	920842	Jun. 01, 2018	May 31, 2019
Digital Multimeter Fluke	87-III	70360742	Jun. 29, 2018	Jun. 28, 2019
AC Power Supply Extech	CFW-105	E000603	NA	NA
True RMS Clamp Meter / Fluke	325	31130711WS	May 22, 2018	May 21, 2019

### 4.6.4 Test Procedure

- The EUT was placed inside the environmental test chamber and powered by nominal AC voltage.
- Turn the EUT on and couple its output to a spectrum analyzer.
- Turn the EUT off and set the chamber to the highest temperature specified.
- Allow sufficient time (approximately 30 min) for the temperature of the chamber to stabilize, turn the EUT on and measure the operating frequency after 2, 5, and 10 minutes.
- Repeat step 2 and 3 with the temperature chamber set to the lowest temperature.
- The test chamber was allowed to stabilize at +20 degree C for a minimum of 30 minutes. The supply voltage was then adjusted on the EUT from 85% to 115% and the frequency record.

#### 4.6.5 Deviation from Test Standard

No deviation.

#### 4.6.6 EUT Operating Condition

Set the EUT transmit at un-modulation mode to test frequency stability.

#### 4.6.7 Test Results

Frequency Stability Versus Temp.									
Operating Frequency: 5180MHz									
Temp. (°C)	Power Supply (Vac)	0 Minute		2 Minute		5 Minute		10 Minute	
		Measured Frequency (MHz)	Result	Measured Frequency (MHz)	Result	Measured Frequency (MHz)	Result	Measured Frequency (MHz)	Result
50	120	5179.9793	PASS	5179.9767	PASS	5179.9778	PASS	5179.9771	PASS
40	120	5179.9885	PASS	5179.9850	PASS	5179.9886	PASS	5179.9880	PASS
30	120	5180.0018	PASS	5179.9996	PASS	5180.0020	PASS	5179.9987	PASS
20	120	5179.9832	PASS	5179.9811	PASS	5179.9814	PASS	5179.9803	PASS
10	120	5180.0093	PASS	5180.0109	PASS	5180.0128	PASS	5180.0116	PASS
0	120	5180.0028	PASS	5179.9997	PASS	5180.0042	PASS	5179.9996	PASS

Frequency Stability Versus Voltage									
Operating Frequency: 5180MHz									
Temp. (°C)	Power Supply (Vac)	0 Minute		2 Minute		5 Minute		10 Minute	
		Measured Frequency (MHz)	Result	Measured Frequency (MHz)	Result	Measured Frequency (MHz)	Result	Measured Frequency (MHz)	Result
20	138	5179.9837	PASS	5179.9818	PASS	5179.9822	PASS	5179.9804	PASS
	120	5179.9832	PASS	5179.9811	PASS	5179.9814	PASS	5179.9803	PASS
	102	5179.9827	PASS	5179.9813	PASS	5179.9823	PASS	5179.9798	PASS

## 4.7 6dB Bandwidth Measurement

### 4.7.1 Limits of 6dB Bandwidth Measurement

The minimum of 6dB Bandwidth Measurement is 0.5MHz.

### 4.7.2 Test Setup

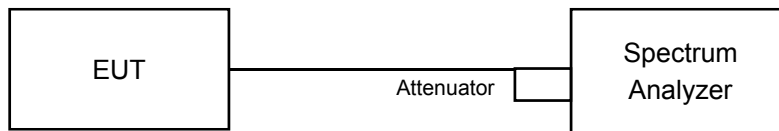

### 4.7.3 Test Instruments

Refer to section 4.1.2 to get information of above instrument.

### 4.7.4 Test Procedure

#### Measurement Procedure REF

- Set resolution bandwidth (RBW) = 100kHz
- Set the video bandwidth (VBW)  $\geq 3 \times$  RBW, Detector = Peak.
- Trace mode = max hold.
- Sweep = auto couple.
- Measure the maximum width of the emission that is constrained by the frequencies associated with the two amplitude points (upper and lower) that are attenuated by 6 dB relative to the maximum level measured in the fundamental emission

### 4.7.5 Deviation from Test Standard

No deviation.

### 4.7.6 EUT Operating Condition

The software provided by client to enable the EUT under transmission condition continuously at lowest, middle and highest channel frequencies individually.

#### 4.7.7 Test Results

##### 802.11a

Channel	Frequency (MHz)	6dB Bandwidth (MHz)				Minimum Limit (MHz)	Pass / Fail
		Chain 0	Chain 1	Chain 2	Chain 3		
149	5745	16.38	16.40	16.32	16.39	0.5	Pass
157	5785	16.37	16.41	16.06	16.34	0.5	Pass
165	5825	16.38	16.40	16.33	16.35	0.5	Pass

##### 802.11n (HT20)

Channel	Frequency (MHz)	6dB Bandwidth (MHz)				Minimum Limit (MHz)	Pass / Fail
		Chain 0	Chain 1	Chain 2	Chain 3		
149	5745	17.22	17.62	16.34	17.61	0.5	Pass
157	5785	17.61	17.62	16.59	16.36	0.5	Pass
165	5825	17.61	17.63	16.61	16.97	0.5	Pass

##### 802.11n (HT40)

Channel	Frequency (MHz)	6dB Bandwidth (MHz)				Minimum Limit (MHz)	Pass / Fail
		Chain 0	Chain 1	Chain 2	Chain 3		
151	5755	35.31	32.71	35.18	35.25	0.5	Pass
159	5795	33.99	35.20	35.24	35.30	0.5	Pass

##### 802.11ac (VHT80)

Channel	Frequency (MHz)	6dB Bandwidth (MHz)				Minimum Limit (MHz)	Pass / Fail
		Chain 0	Chain 1	Chain 2	Chain 3		
155	5775	76.43	75.52	76.02	75.54	0.5	Pass

##### 802.11ac (VHT80+VHT80)

Channel	Frequency (MHz)	6dB Bandwidth (MHz)		Minimum Limit (MHz)	Pass / Fail
		Chain 2	Chain 3		
155	5775	76.09	75.85	0.5	Pass



### Spectrum Plot of Worst Value

#### 802.11a

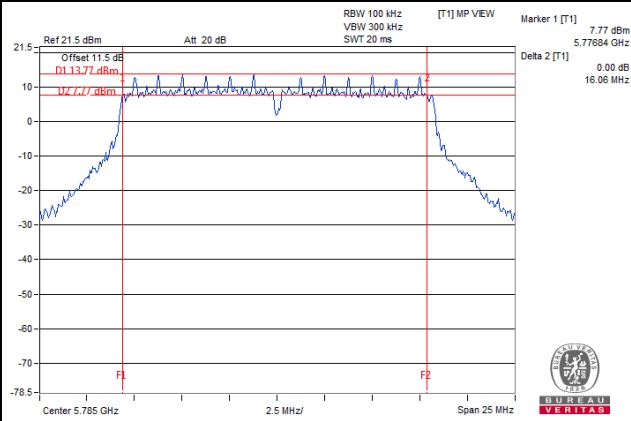

#### 802.11n (HT20)

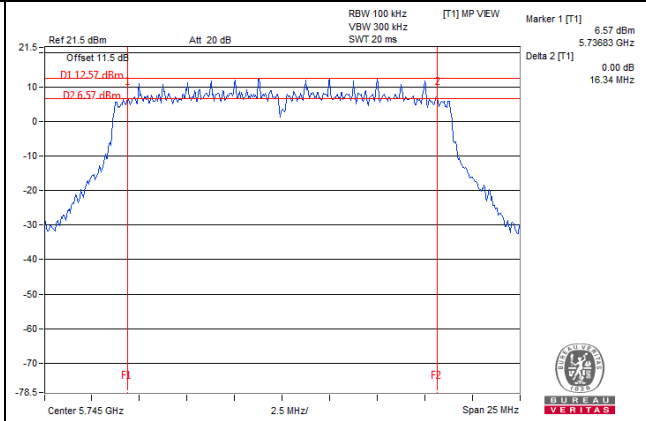

#### 802.11n (HT40)

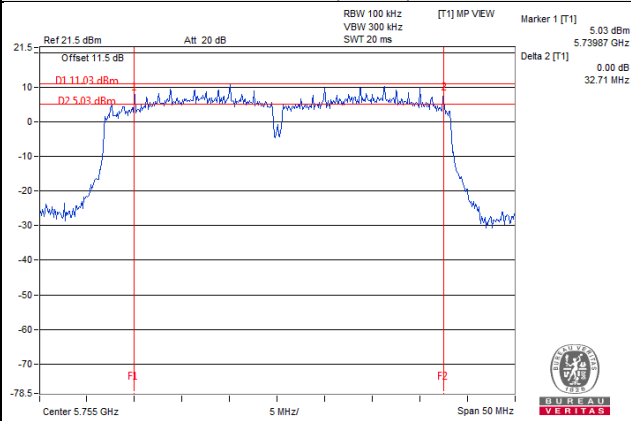

#### 802.11ac (VHT80)

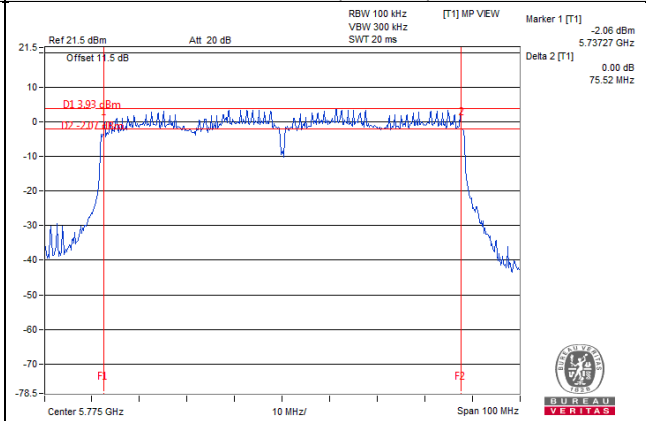

#### 802.11ac (VHT80+VHT80)

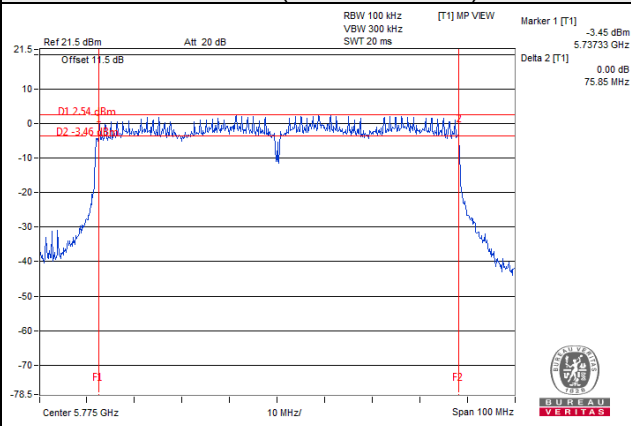

## 5 Pictures of Test Arrangements

Please refer to the attached file (Test Setup Photo).

## Annex A- Radiated Out of Band Emission (OOBE) Measurement (For U-NII-3 band)

802.11a

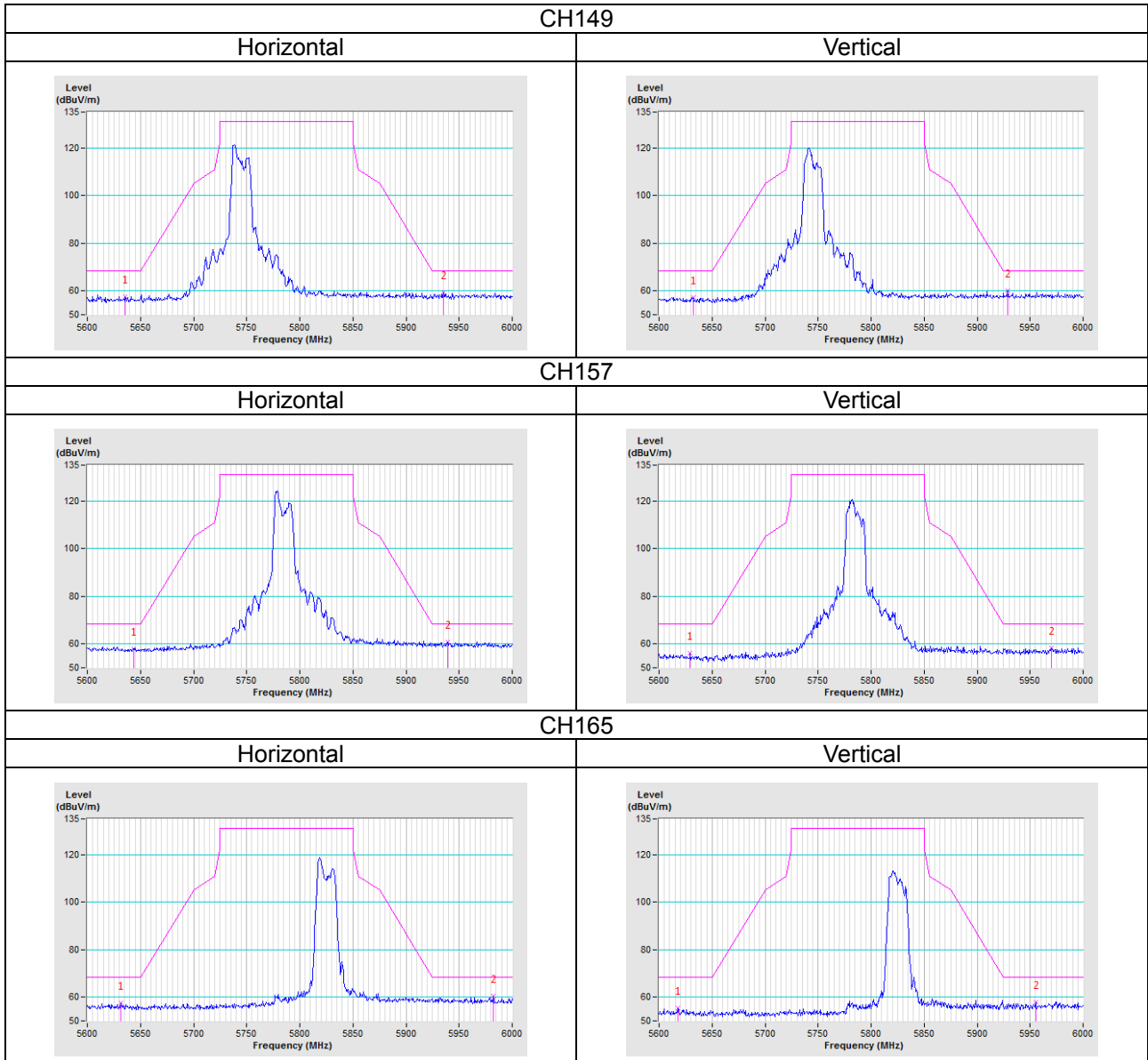

802.11n (HT20)

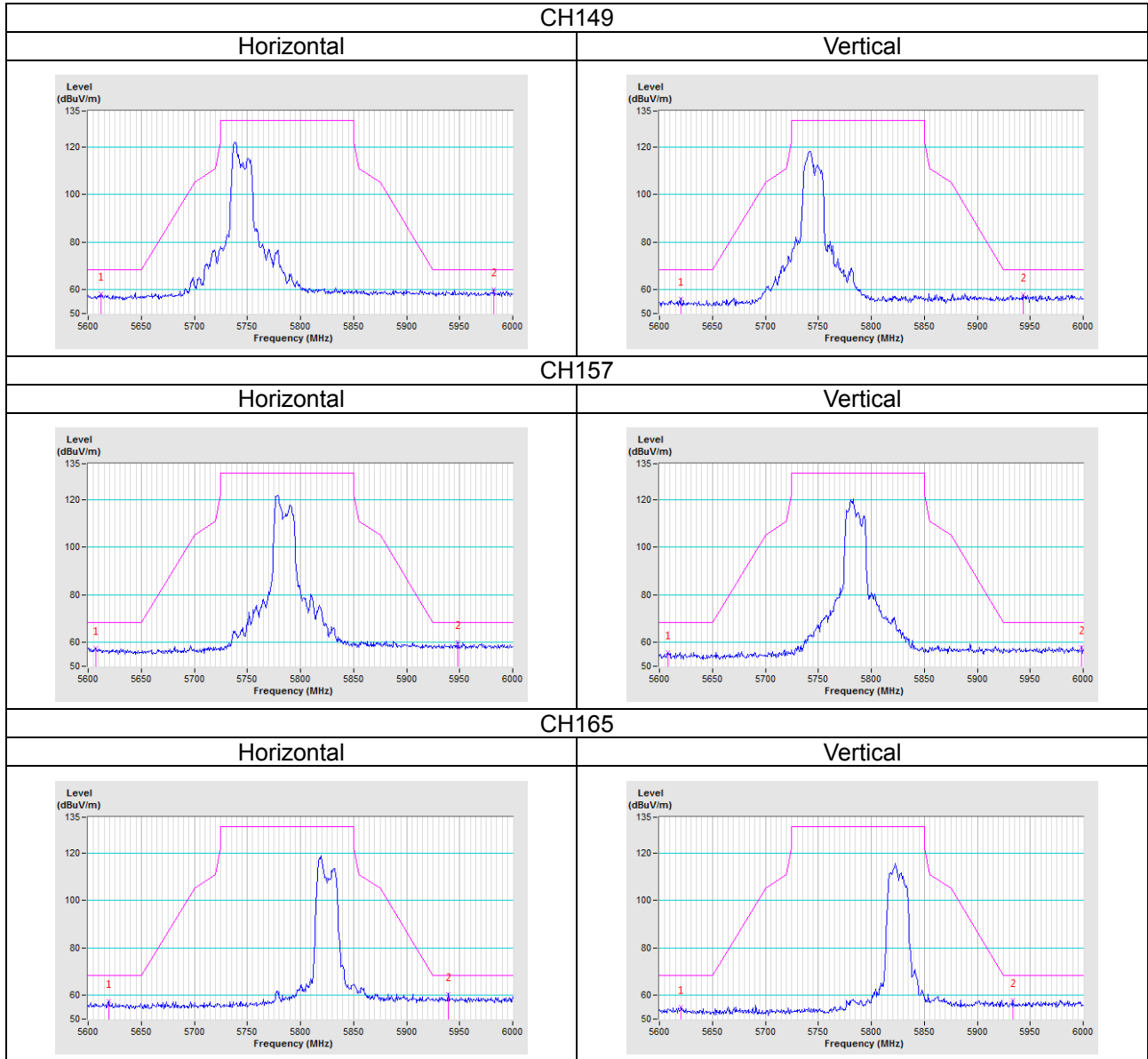

802.11n (HT40)

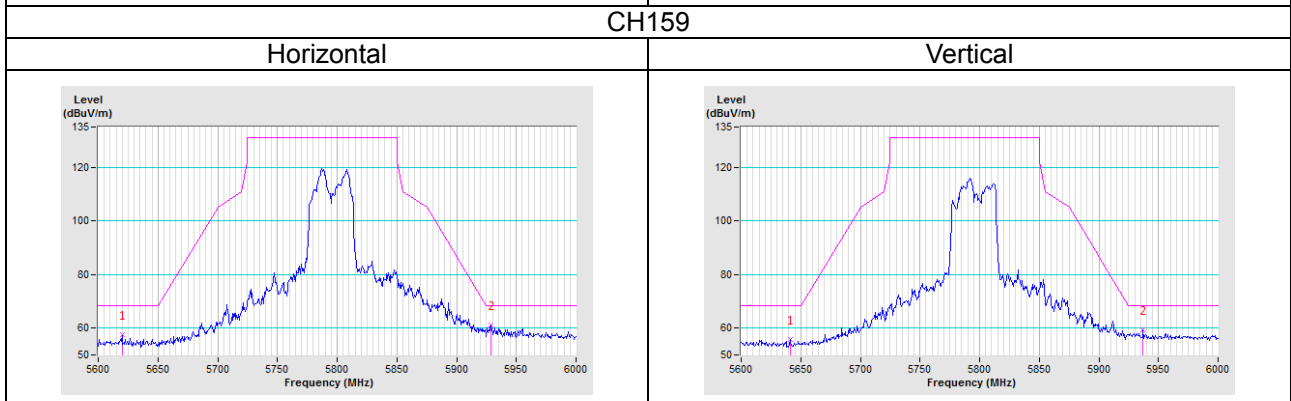
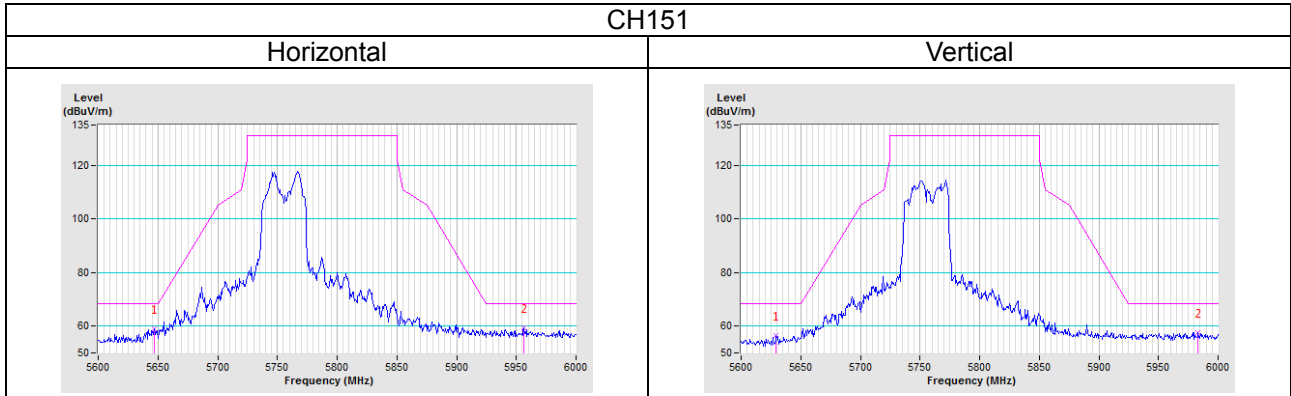

802.11ac (VHT80)

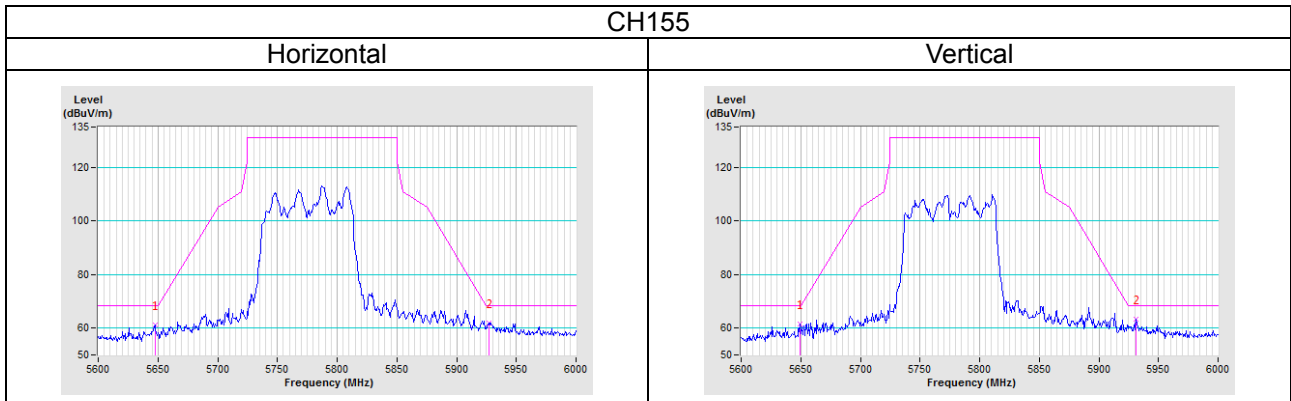

802.11ac (VHT80+VHT80)

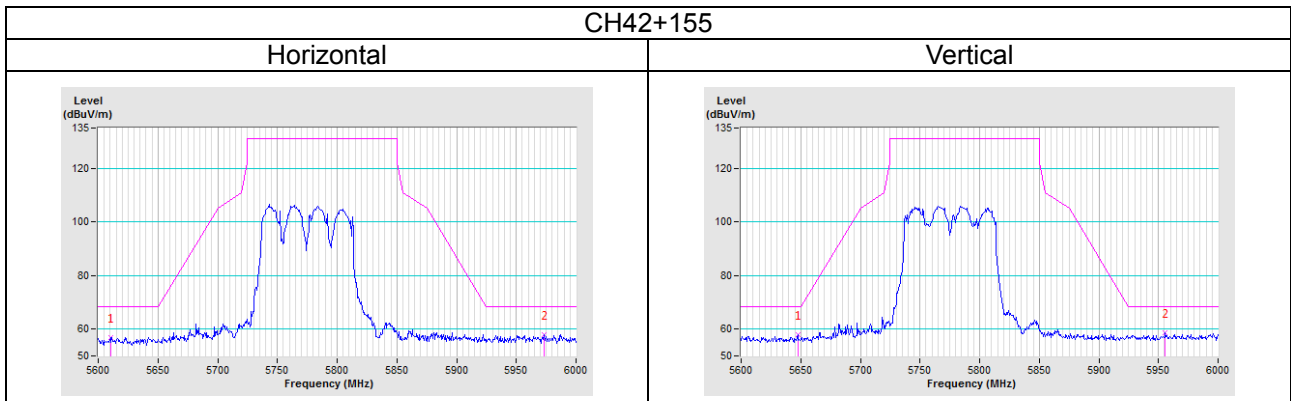

## Appendix – Information of the Testing Laboratories

We, Bureau Veritas Consumer Products Services (H.K.) Ltd., Taoyuan Branch, were founded in 1988 to provide our best service in EMC, Radio, Telecom and Safety consultation. Our laboratories are FCC recognized accredited test firms and accredited and approved according to ISO/IEC 17025.

If you have any comments, please feel free to contact us at the following:

**Lin Kou EMC/RF Lab**

Tel: 886-2-26052180

Fax: 886-2-26051924

**Hsin Chu EMC/RF/Telecom Lab**

Tel: 886-3-6668565

Fax: 886-3-6668323

**Hwa Ya EMC/RF/Safety Lab**

Tel: 886-3-3183232

Fax: 886-3-3270892

**Email:** [service.adt@tw.bureauveritas.com](mailto:service.adt@tw.bureauveritas.com)

**Web Site:** [www.bureauveritas-adt.com](http://www.bureauveritas-adt.com)

The address and road map of all our labs can be found in our web site also.

--- END ---