

2JE07i

5.0 GHz ISM Surface Mount

Key Features

5.0 GHz ISM

- 4920-5925 MHz

Surface Mount

Easy to Integrate

Compact Size

Ceramic Material

Ground Plane Dependent

Dimensions 5.2 x 2 x 1.2 mm



1. Antenna and electrical specifications

Parameters	5.0 GHz ISM Antenna
Standards	WiFi, ISM,
Band (MHz)	5.0 GHz
Frequency (MHz)	4920-5925
Return Loss (dB)	~-11.2
VSWR	~2.1:1
Efficiency (%)	~55.9
Peak Gain (dBi)	~2.1
Average Gain (dB)	~-2.6
Impedance (Ohm)	50
Polarisation	Linear
Radiation Pattern	Omni-Directional
Max. Input Power (W)	10

Antenna Measurement Conditions:

Mounted on ground plane of 50 x 90 mm

Measured in Certified CTIA 3D Anechoic Chamber

2. Mechanical and environmental specifications

Specifications	2JE07i
Mounting Type	Surface Mount
Dimensions (mm)	5.2 x 2 x 1.2
Material	Ceramic
Operating Temperature (C)	-40 to +85
Storage Temperature (C)	-40 to +85
Substance Compliance	RoHS
Typical Shear Force Test	1Kgf according to IEC62137-1-2:2007

3. Antenna parameters

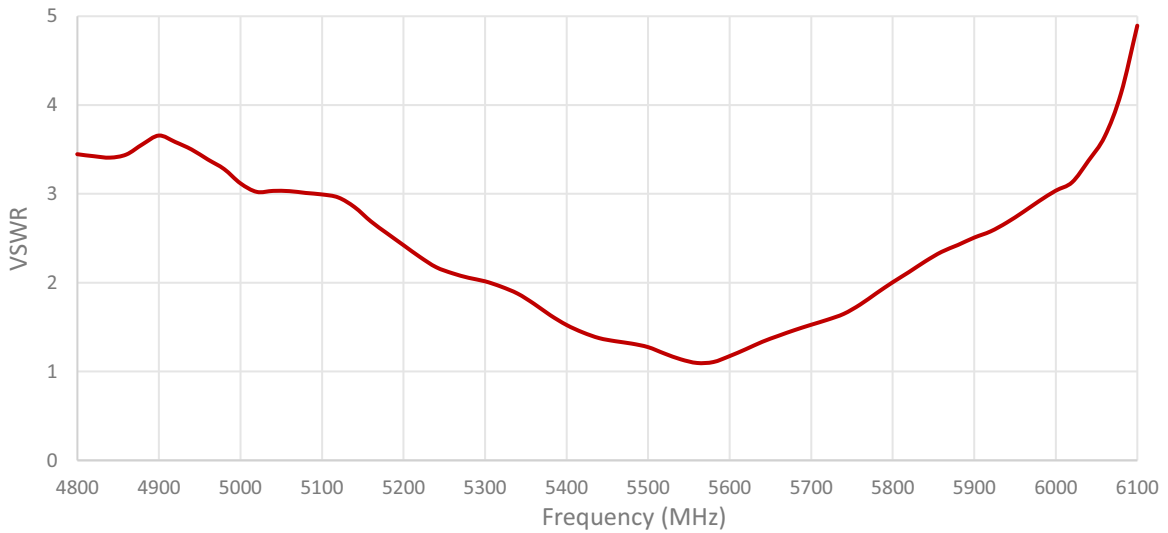
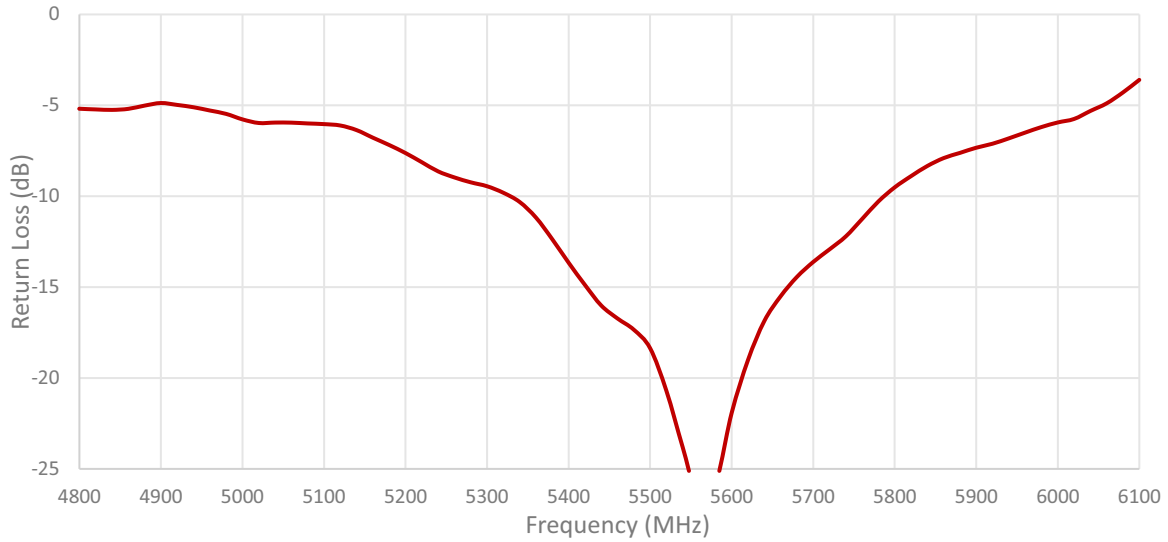

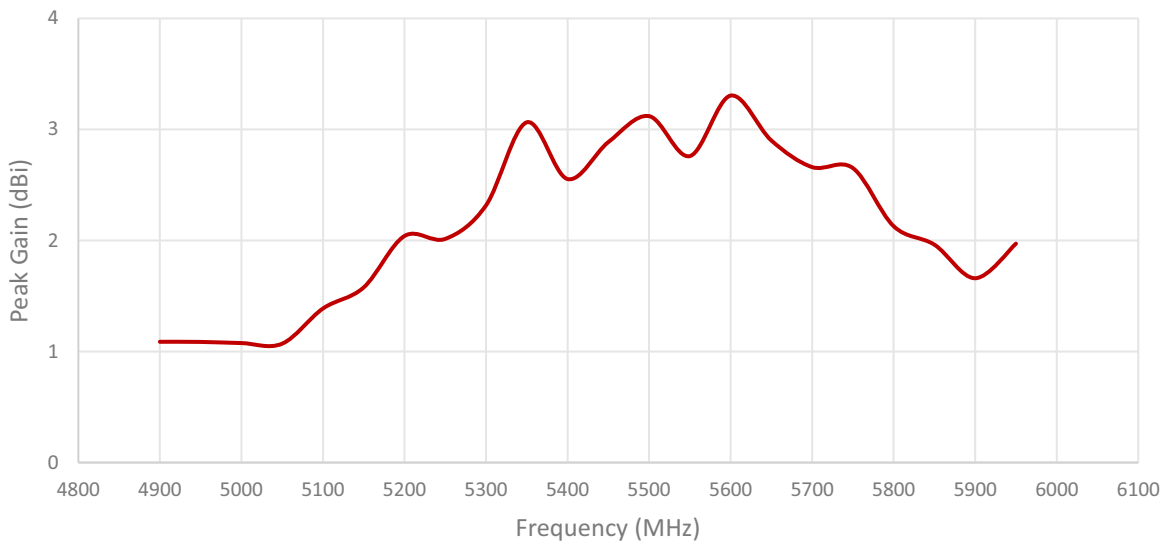
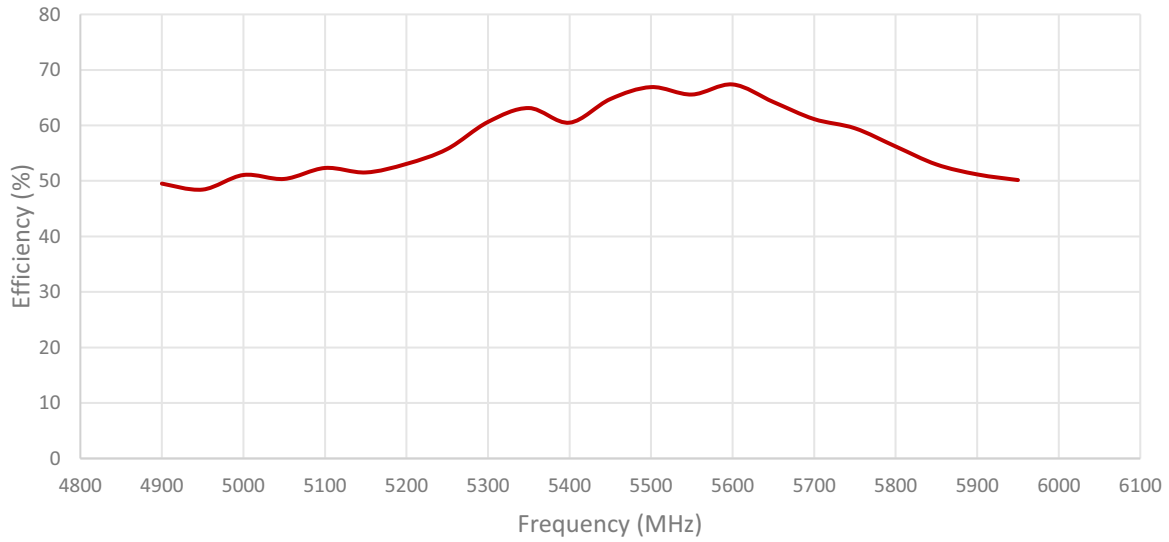

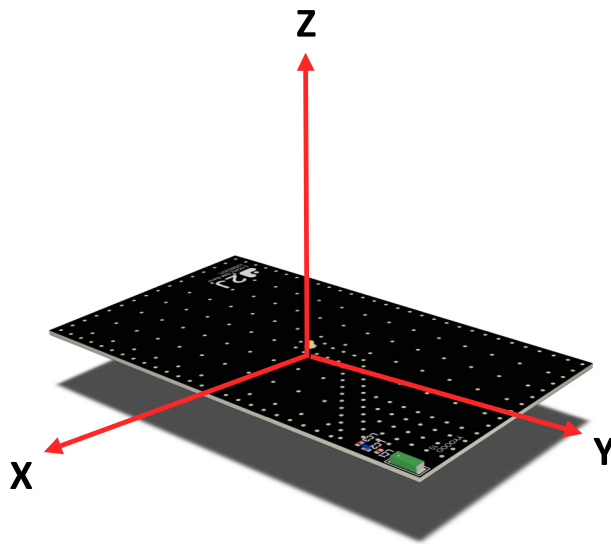
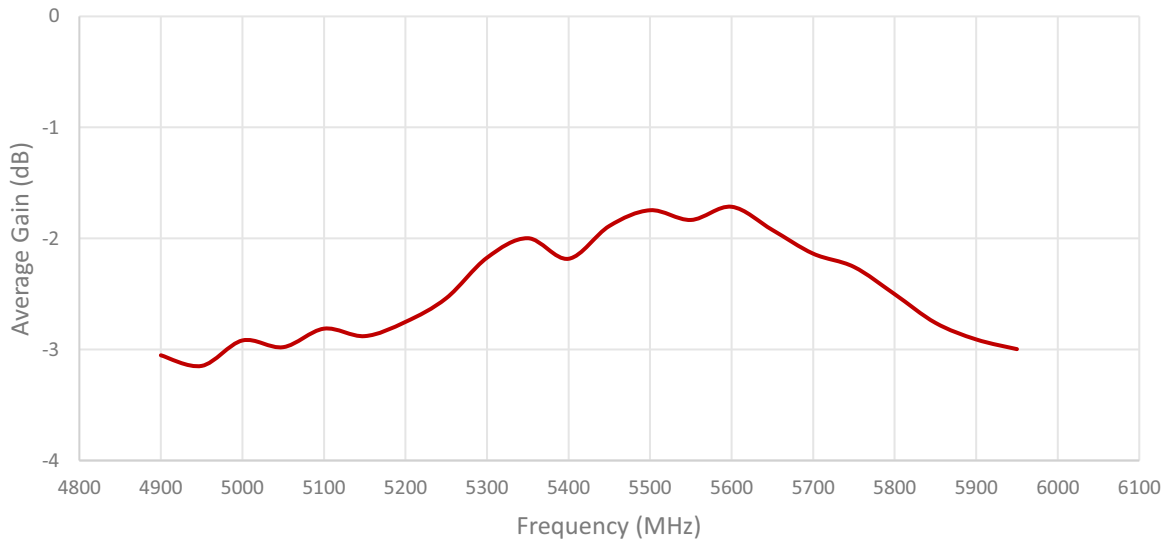

Radiation pattern reference

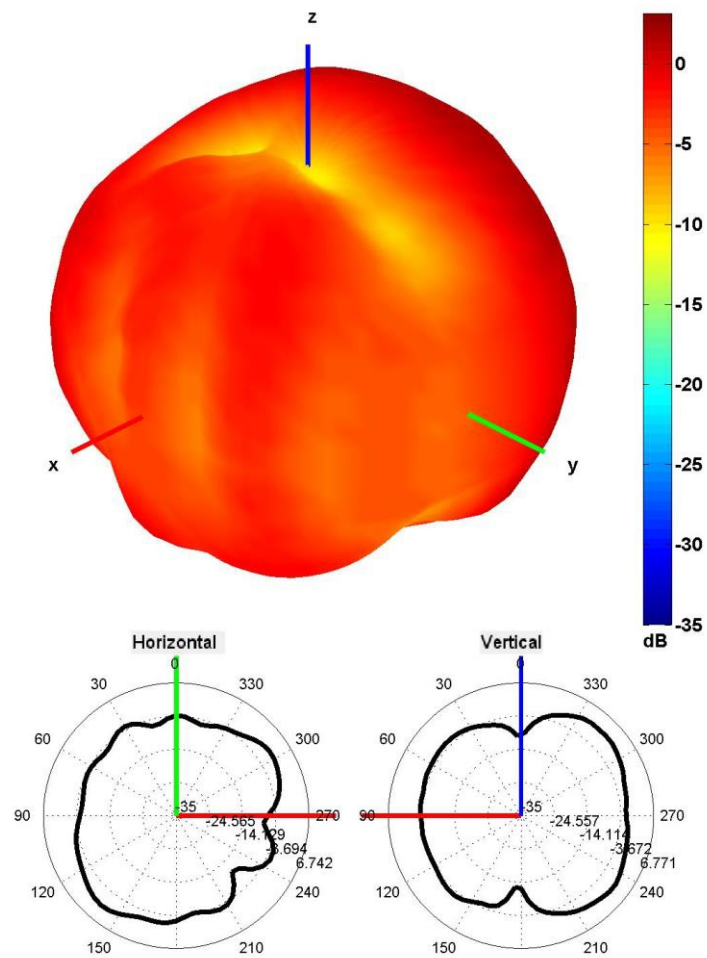

5500 MHz Radiation pattern

4. PCB Layout

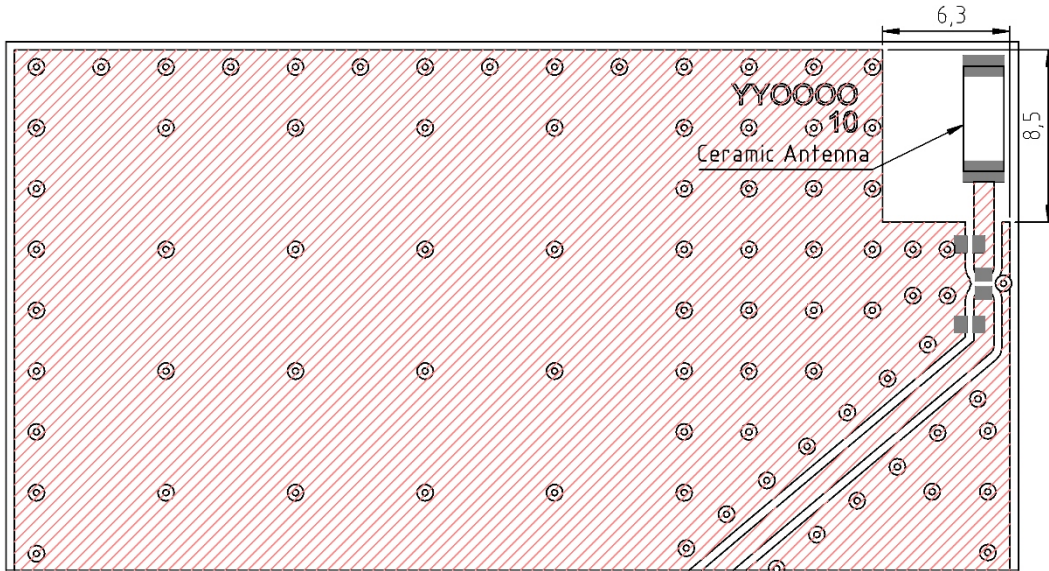

Minimum area required for antenna integration (6.3mm × 8.5mm)

- Solder Region
- Copper Region
- Copper-Free Region

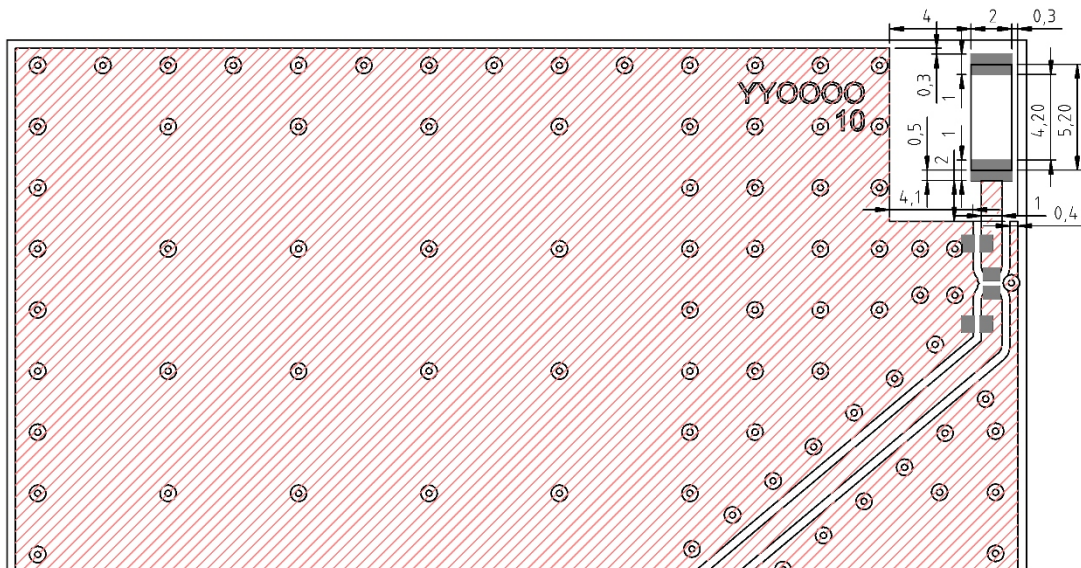

Layout dimensions for antenna integration (mm)

- Solder Region
- Copper Region
- Copper-Free Region

5. Matching Components

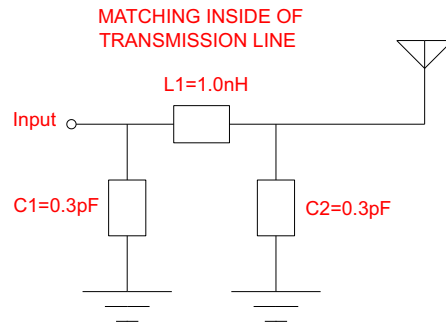

Matching Network Schematic

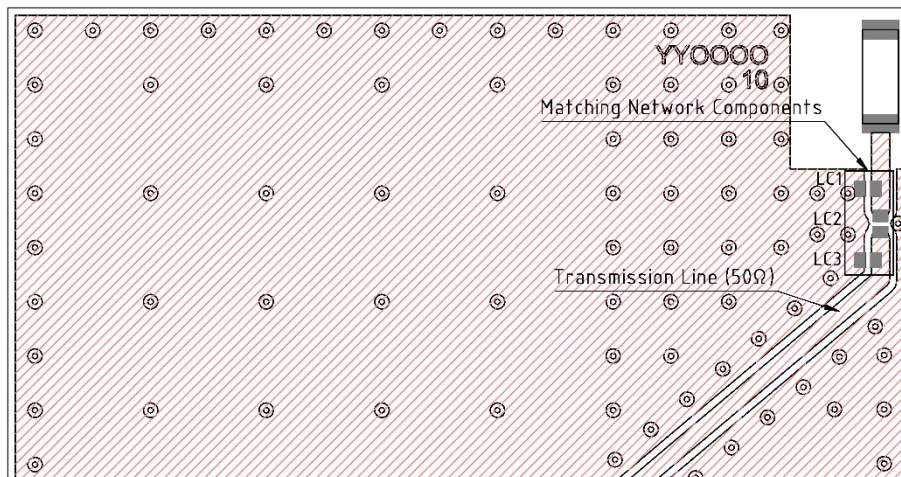

Matching network drawing (LC1=0.3pF, LC2=1.0nH, LC3=0.3pF)



3D View of matching components and recommended values (LC1 = 0.3pF, LC2=1.0nH, LC3= 0.3pF)

REFLOW TEMPERATURE PROFILE

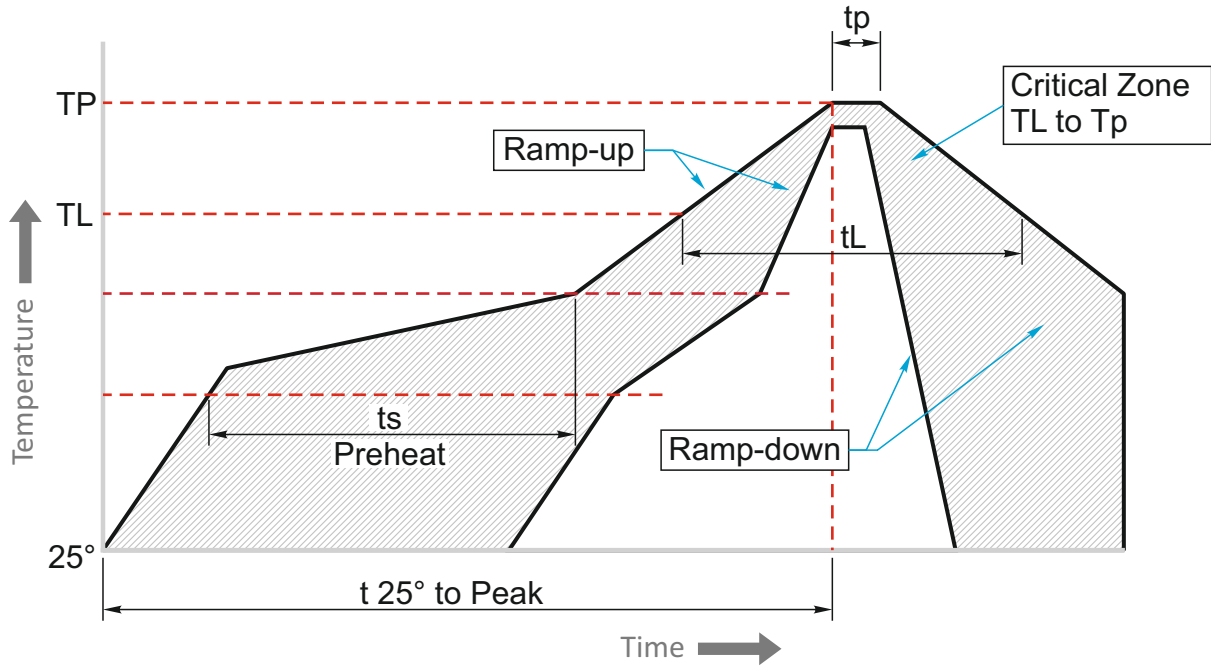

Phase	Profile features	Sn-Pb Assembly	Pb-Free Assembly (SnAgCu)
RAMP-UP	Avg. Ramp-up Rate ($T_{s_{max}}$ to TP)	3°C / second (max)	3°C / second (max)
PREHEAT	-Temperature Min Rate ($T_{s_{min}}$) -Temperature Max Rate ($T_{s_{min}}$) -Time ($t_{s_{min}}$ to $t_{s_{max}}$)	100°C 150°C 60-120 seconds	150°C 200°C 60-120 seconds
REFLOW	-Temperature (T_L) -Total Time above T_L (t_L)	183°C 60-150 seconds	217°C 60-150 seconds
PEAK	-Temperature (T_p) -Time (t_p)	235°C 10-30 seconds	260°C 20-40 seconds
RAMP-DOWN	Rate	6°C / second max.	6°C / second max.
Time from 25°C to Peak Temperature		6 minutes max.	8 minutes max.

6. Evaluation Board

90mm x 50mm

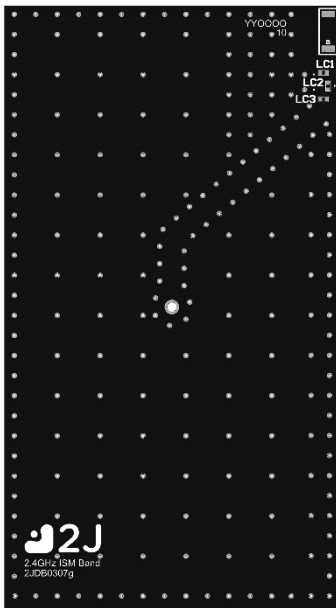

Front View without Antenna

90mm x 50mm

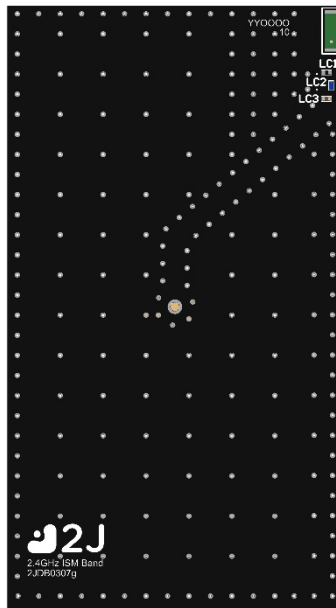

Front View with Antenna

90mm x 50mm

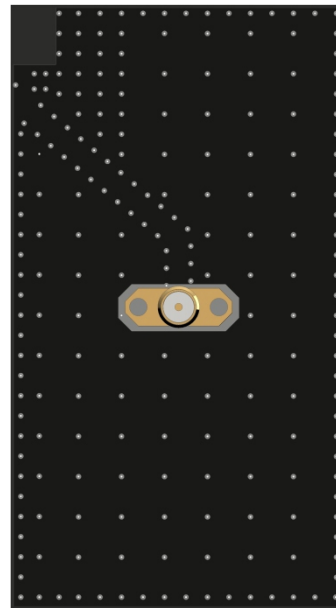

Back View

90mm x 11.5mm
(PCB: 0.8mm, Antenna: 1.2mm,
Connector: 9.5mm)

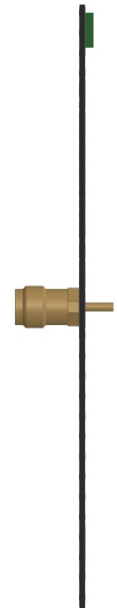

Side View

7. Antenna drawings

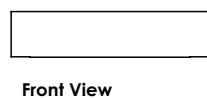
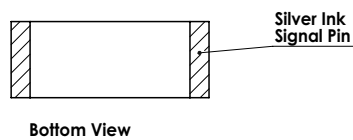
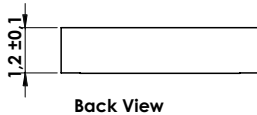
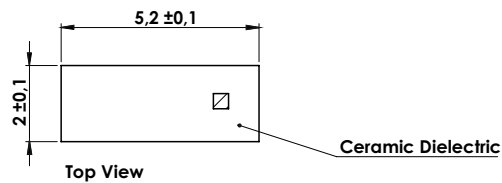

8. Tape and Reel Information

Top View

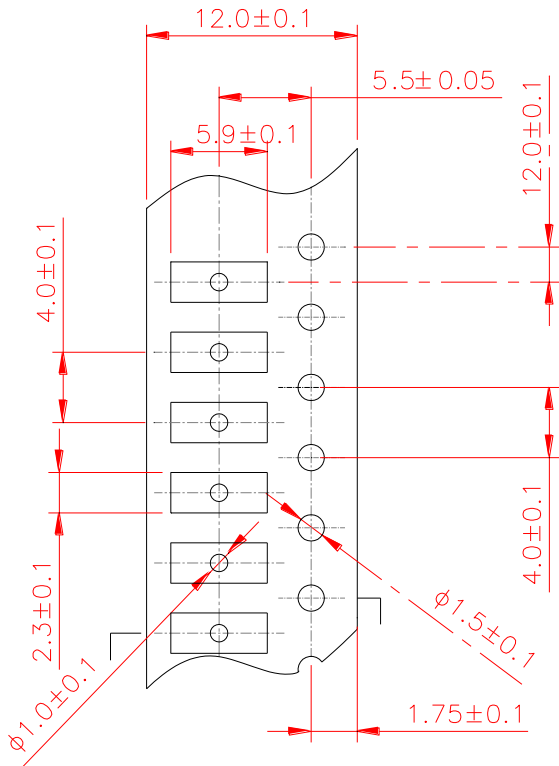

Front View

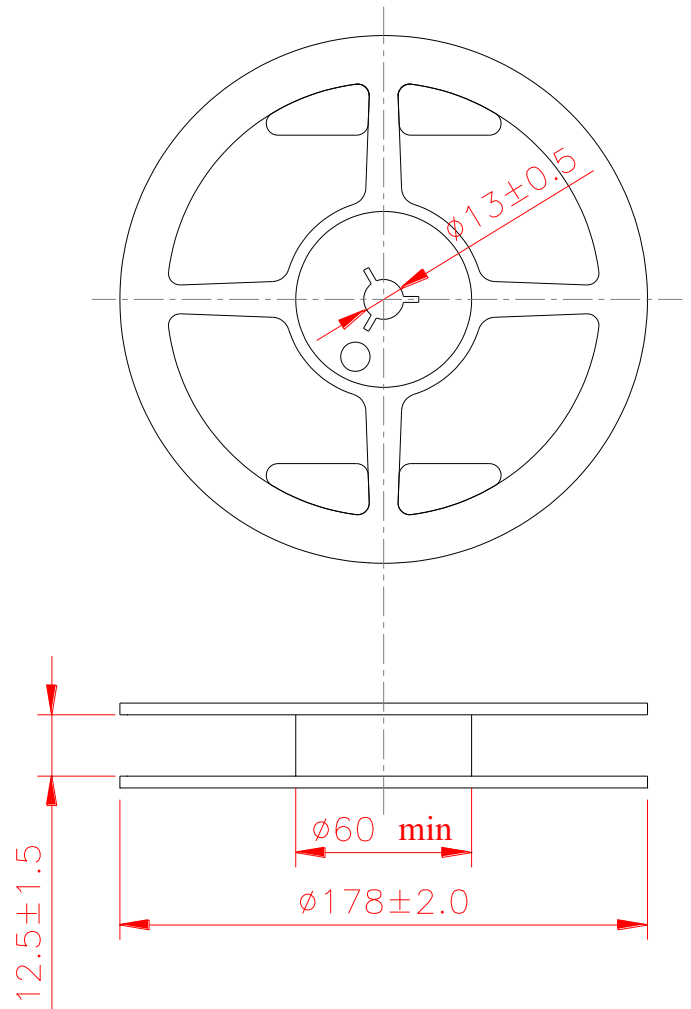
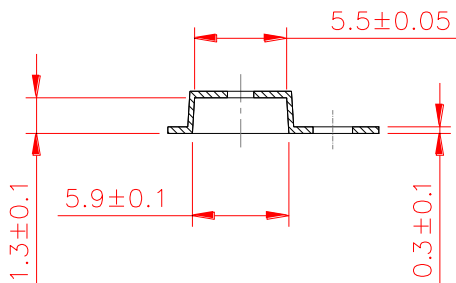

Tape and Reel Specifications

9. Packaging

PACKAGING SPECIFICATION

Antenna	2JE07i
REEL	
Max Quantity per Reel	3000
REEL BOX	
Reels per Box	1
Reel Box Dimensions (cm)	18.5 x 18.5 x 3
Reel Box Weight (Kg)	0.27
CARTON	
Reels per Carton	10
Max Quantity per Carton	30,000
Reel Carton Dimensions (cm)	33 x 21 x 21
Reel Carton Weight (Kg)	3.1

Storage Conditions:

- Storage Temperature Range: -40 °C to +85 °C
- Oxidizable material. Store for 12 months in vacuum sealed bag.
- Repack material after use by re-sealing package.

10. Antenna Images

