

70mm

110mm

**NIIMBOT**

# Quick Start Guide

**Smart** Label Printer

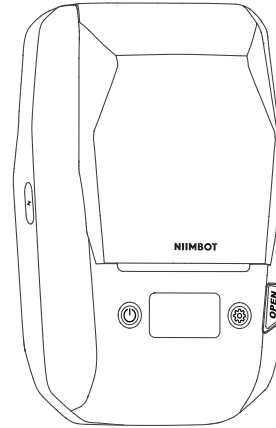

NIIMBOT M2\_H

**Notice:** If the device cannot be turned on, please charge for one hour.

**Wuhan Jingchen Intelligent Identification Technology Co., Ltd.**

Support Email : [service@niimbot.com](mailto:service@niimbot.com)

Official Website : [www.niimbot.net](http://www.niimbot.net)

Office Address : **Creative Workshop No. 5, Creative World, Yezhihu West Road, Hongshan District, Wuhan, China**

Production Address : 3rd Floor, Building 1 Workshop, Building 1 Spare Warehouse, Linkong Economic Demonstration Industrial Park, Hengdian Street, Huangpi District, Wuhan, China

© 2022 NIIMBOT. All rights reserved.

NIIMBOT is a brand under Wuhan Jingchen Intelligent Identification Technology Ltd.

**NIIMBOT**

# Quick Start Guide

**Smart** Label Printer

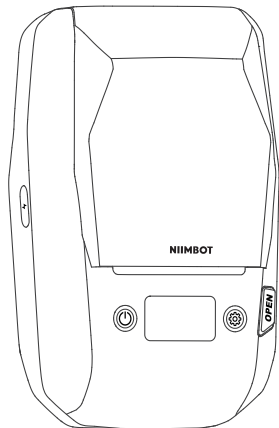

**Notice:** If the device cannot be turned on, please charge for one hour.

**Wuhan Jingchen Intelligent Identification Technology Co., Ltd.**

Support Email : [service@niimbot.com](mailto:service@niimbot.com)

Official Website : [www.niimbot.net](http://www.niimbot.net)

Office Address : Creative Workshop No. 5, Creative World, Yezhihu

West Road, Hongshan District, Wuhan, China

Production Address : 3rd Floor, Building 1 Workshop, Building 1 Spare

Warehouse, Linkong Economic Demonstration Industrial Park,

Hengdian Street, Huangpi District, Wuhan, China

© 2022 NIIMBOT. All rights reserved.

NIIMBOT is a brand under Wuhan Jingchen Intelligent Identification Technology Ltd.

**NIIMBOT M2\_H**

# 01

## Package Contents



Smart Label Printer \*1



USB Type-C Cable \*1



Thermal Transfer Ribbon \*1

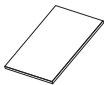

Product Manual \*1

# 02

## Specifications

Product	Label Printer	Model	NIIMBOT M2_H
Dimensions	108*178*74mm	Weight	764g
Charging Time	3 - 4 hours	Input	5V DC, 2A
Battery Capacity	2000mAh	Printing Method	Thermal Transfer Printing
Printing Resolution	300dpi	Printing Width	20-50mm
Connectivity	Bluetooth、Type-C	Charge	Type-C
Transmit Power	4dBm(Maximum)	Operating Temperature	0~40°C

# 03

## Product Description

### 03-1 Label Printer

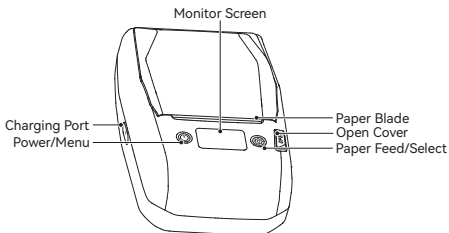

### 03-2 The Carbon Ribbon Parts

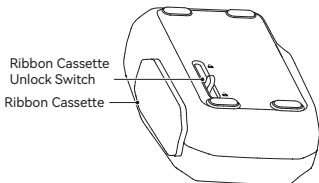

# 04

## Operation Instruction

### 04-1 Loading Paper

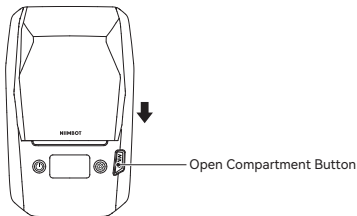

- 1 Press the Open Compartment Button.

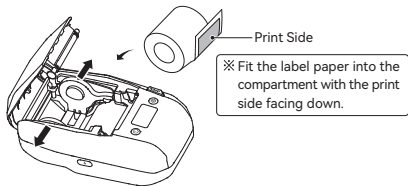

- 2 Adjust the paper guide to insert the label paper.

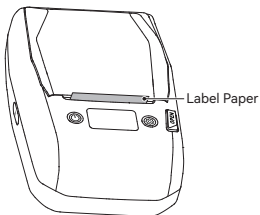

- 3 Pull the label paper out of the paper compartment and close the compartment cover.

## 04-2 Carbon Ribbon Installation Instructions

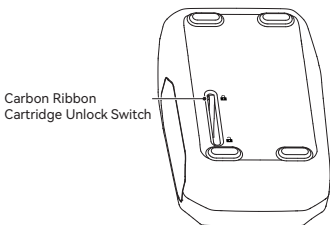

- 1 Carbon Ribbon Cartridge Unlock Switch

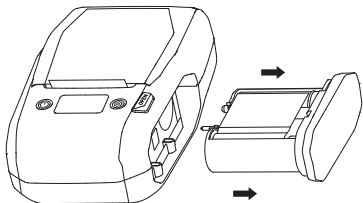

## ② Carbon Ribbon Cartridge Unlock Switch

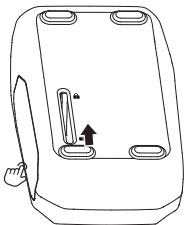

- ③ Insert the carbon ribbon cartridge, holding it with one hand while securing the lock with the other.



## 04-3 Software Download

### 01.Download the NIIMBOT APP

Before using the printer, please install the NIIMBOT app from Google Play or the App Store.



**NIIMBOT**

Design & Print APP  
easy to download and use



※ More information available on the NIIMBOT app.

Sign in to NIIMBOT ▶

Me ▶

Help Center ▶

Hardware

### 02.Download the “NIIMBOT” Desktop Version

You can download and install "NIIMBOT" Desktop version from our official website ([www.niimbot.com](http://www.niimbot.com)).

※ Note: If you need to connect the device to your computer, please use the official-provided data cable or a data cable that supports data transfer.

## 04-4 Printing Label

- 1 After downloading the APP, make sure your phone's Bluetooth is on.  
※ Note: For Android phones, location permission must be granted.



Turn on Bluetooth

- 2 Open the APP, search and connect to the device through Bluetooth.  
※ Notice: If a PIN code is required, input 0000 or 1234.
- 3 After connecting, enter the "Canvas" page to edit.

## Special Notes

Images of products, accessories, and the app in this manual are for illustrative purposes only and may be different from actual products. Products are subject to change without prior notice.



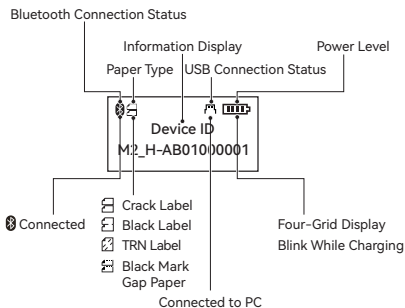

# 05

## The Control Panel

### 05-1 Interface Description



#### Paper Types

-  Crack Label: There is a gap between two label papers.
-  Black Label: Two label papers are connected, and there is a black mark on the back of the label paper.
-  TRN Label: The label paper is made of transparent material.
-  Black Mark Gap Paper: There is a gap between two label papers, and there is a black mark on the back of the label paper.

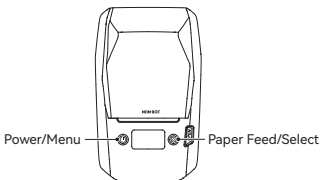

## 05-2 Operation Instructions

- 1.The Power/Menu Button: Menu Selection.
- 2.The Paper Feed/Select Button: Function Selection.

## 04-3 Function Description

Main Menu	Secondary Menu	Tertiary Menu	Function Description
Paper Calibration	---	---	Calibrate when encountering paper feed issues.
Print Density	1/2/ 3/4/5	---	Adjust the print density.
Print Self-Test Page	---	---	View printer and consumables information.
Auto Shutdown	15 Minutes 30 Minutes 60 Minutes Never	---	Set the auto-shutdown time.
Printer Information	Hardware Version Firmware Version Bluetooth MAC	---	Check printer hardware and firmware version.
Advanced Settings	Languages	Simplified Chinese Traditional Chinese English	Choose the language for the screen display.

Main Menu	Secondary Menu	Tertiary Menu	Function Description
Advanced Settings	Paper Types	Crack Label Black Label TRN Label Black Mark	Select the type of label paper in use
	Restore to factory default settings	---	Select and restore to factory default settings

# 06

## Safety Precautions

Please read all the instructions and warnings in this manual carefully before using this product to ensure the proper functioning of the device and your safety.

### \*Warnings



Don't disassemble the product without authorization. Disassembled products cannot be returned or exchanged.



Do not wipe the product with corrosive chemicals or cleaning agents.



Do not use the product near places with flammable products such as gas stations or fuel depots.

Please keep the product and accessories out of the reach of children or they must be used under the supervision and guidance of a guardian;  
 Turn off the power immediately when water gets into the product;  
 Turn off the power immediately in case of any product malfunction;  
 If you want to use a power adapter, always use one that is safe, regulatory-compliant, and compatible;  
 Do not use batteries of different specifications, or they may cause the safety protection to be ineffective;

6. Do not expose batteries to fire or heat; do not squeeze or cut the battery pack with mechanical devices, which may cause an explosion.
7. Do not expose batteries at high temperatures, which may cause explosion or leakage of flammable liquids or gases. Extreme low air pressure may also cause explosion or leakage of flammable liquids or gases.
8. If smoke or smell comes from the product or the power adapter, please unplug the power adapter immediately and avoid any burns.

### **\*Special Notes**

Please purchase our product models designed for specific your country or region through the official NIIMBOT store or NIIMBOT authorized channels. Purchasing a NIIMBOT product through an unauthorized source may expose you to piracy risks, compatibility issues with your local environment, or other factors that could affect the product's proper functionality. Additionally, NIIMBOT may not be able to provide support for issues related to products obtained through unauthorized channels.

# 07

## Related Statements

### FCC Statement

This device complies with part 15 of the FCC Rules. Operation is subject to the following two conditions: (1) this device may not cause harmful interference, and (2) this device must accept any interference received, including interference that may cause undesired operation.

Any changes or modifications not expressly approved by the party responsible for compliance could void the user's authority to operate the equipment.

NOTE: This equipment has been tested and found to comply with the limits for a Class B digital device, pursuant to Part 15 of the FCC Rules. These limits are designed to provide reasonable protection against harmful interference in a residential installation. This equipment generates, uses and can radiate radio frequency energy and, if not installed and used in accordance with the instructions, may cause harmful interference to radio communications.

However, there is no guarantee that interference will not occur in a particular installation. If this equipment does cause harmful interference to radio or television reception, which can be determined by turning the equipment off and on, the user is encouraged to try to correct the interference by one or more of the following measures:

- Reorient or relocate the receiving antenna.
- Increase the separation between the equipment and receiver.
- Connect the equipment into an outlet on a circuit different from that to which the receiver is connected.



-- Consult the dealer or an experienced radio/TV technician for help.

The device has been evaluated to meet general RF exposure requirement. The device can be used in portable exposure condition without restriction.

## **Declaration of conformity**

Hereby, Wuhan Jingchen Intelligent Identification Technology Co., Ltd. declares that this device is in compliance with the essential requirements and other relevant provisions of Radio Equipment Directive (RED) 2014/53/EU. This product can be used across EU member states. This device can be used in European Union.

Hereby, [Wuhan Jingchen Intelligent Identification Technology Co., Ltd.] declares that the radio equipment type [NIIMBOT M2\_H] is in compliance with Directive 2014/53/EU.

The full text of the EU declaration of conformity is available at the following internet address: <http://www.niimbot.com>.

## **Canadian Statement**

This device contains licence-exempt transmitter(s)/receiver(s) that comply with Innovation, Science and Economic Development Canada's licence-exempt RSS(s). Operation is subject to the following two conditions:

- (1) This device may not cause interference.
- (2) This device must accept any interference, including interference that may cause undesired operation of the device.

L'émetteur/récepteur exempt de licence contenu dans le présent appareil est conforme aux CNR d'Innovation, Sciences et Développement économique Canada applicables aux appareils radio exempts de licence. L'exploitation est autorisée aux deux conditions suivantes :

- (1) L'appareil ne doit pas produire de brouillage;
- (2) L'appareil doit accepter tout brouillage radioélectrique subi, même si le brouillage est susceptible d'en compromettre le fonctionnement.