

NIIMBOT

# Product Manual

Smart Label Printer

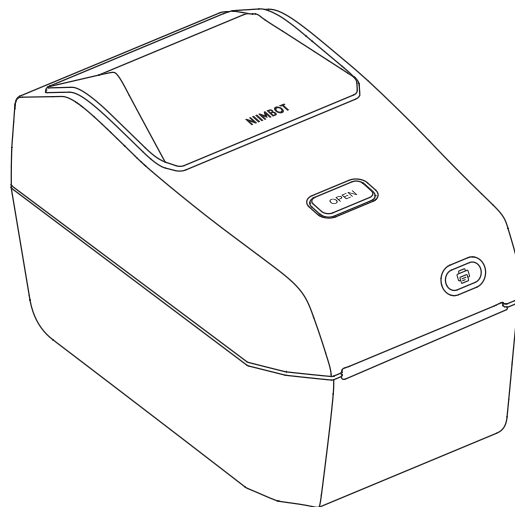

**Wuhan Jingchen Intelligent Identification Technology Co., Ltd.**

Support Email : [service@niimbot.com](mailto:service@niimbot.com)

Official Website : [www.niimbot.com](http://www.niimbot.com)

Manufacturer's Address : No. 5, Creative Workshop, Creative World,  
Yezhihu West Road, Hondshan District, Wuhan, China

© 2023 NIIMBOT. All Rights Reserved.

NIIMBOT is a brand under Wuhan Jingchen Intelligent Identification Technology Ltd.

NIIMBOT K3\_W

## Safety Instructions

Before operating and using the printer, please carefully read the following precautions to prevent personal injury or equipment damage.

### Precautions

- Place this product on a flat and stable surface for use.
- If you notice any unusual odors, heat, smoke, discoloration, deformation, or any other abnormalities while using this product, unplug the power cord immediately and stop using it.
- Do not disassemble this product. For inspection, adjustment, and maintenance, please contact customer support.
- Do not drop, strike, or handle this product improperly.
- Do not allow water to splash onto the printer.
- Before cleaning this product, ensure that the power is turned off and unplug the power cord from the socket to prevent electrical shock or fire.
- Do not use paint thinner, benzene, alcohol, or any other organic solvents to clean this product, as it may damage the surface finish. Use a soft, dry cloth to clean this product.
- Use NIIMBOT official original labels. This product warranty does not cover any malfunctions or damage caused by using third-party labels.
- Do not expose label rolls to environments of direct sunlight, high temperatures, high humidity, or dust. Please store them in a cool place.

### Safety Warning

- The print head is a heated component and can become very hot during and immediately after printing. Do not touch the print head or its surrounding parts to avoid burns.

- Avoid touching the print head and connection plugs to prevent potential damage from electrostatic discharge.
- The paper tearing device has sharp cutting edges. Refrain from using your fingers or other body parts to touch the paper tearing device to prevent cuts.

## Special Notes

Please purchase our product models designed for specific your country or region through the official NIIMBOT store or NIIMBOT authorized channels. Purchasing a NIIMBOT product through an unauthorized source may expose you to piracy risks, compatibility issues with your local environment, or other factors that could affect the product's proper functionality. Additionally, NIIMBOT may not be able to provide support for issues related to products obtained through unauthorized channels.

# 01

## Product Instruction

Thank you for selecting and using the NIIMBOT K3\_W Smart Label Printer. This printer uses thermal printing, requiring no ink or toner. Your only ongoing expense will be label paper. Count on us for long-term reliable label printing and excellent post-sales support. Please take a moment to read the user manual for usage and maintenance instructions.

### 01-1 Package Contents



Smart Label Printer \*1



Label Paper Roll \*1



Product Manual \*1



USB Cable \*1



Power cord \*1  
(may vary in different countries or regions)



Power components\*1

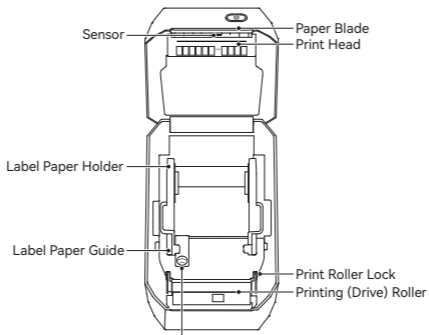
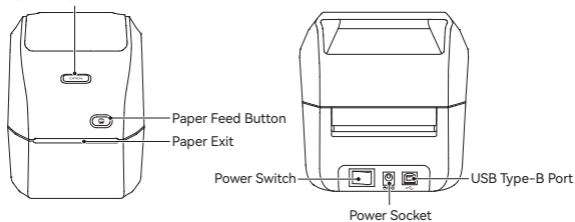

## 01-2 Product Function Description

Paper Compartment Cover Button



Bracket Block (Mainly used for rear express single use)

### 01-3 Button Function Description

| Name   | Operation    | Function Description                                 |
|--|--------------|--|
| Power Button<br>            | Toggle       | Power On/Off   |
| Open Compartment Button<br> | Press        | Open Paper Compartment Cover                         |
| Paper Feed Button<br>       | Short Press  | Standby: Feed One Sheet<br>Printing: Cancel Printing |
|  | Long Press   | Standby: Paper Type Calibration                      |
|  | Double Click | Standby: Print Self-Test Page                        |

### 01-4 Indicator Light Description

| Indicator Light | Status          | Status Description   |
|-----------------|-----------------|--|
| -               | Off             | Powered Off.   |
| Blue            | Always On       | Powered on, but not connected.                                 |
| Blue            | Blinking        | Firmware upgrading.  |
| Green           | Always On       | Printer connected.   |
| Green           | Blinking Slowly | Printer connected.   |
| Green           | Blinking Fast   | Printing   |
| Red             | Always On       | An issue has occurred; refer to the "Troubleshooting" Section. |
| White           | Always On       | Printer connected to Wi-Fi.                                    |

# 02

## Installation and Usage

### 02-1 Power Connection

- 1 Make sure the printer's power switch is in the "Off" (O) position.
- 2 Connect the power cord to the DC power port on the printer.
- 3 Plug the other end of the power cord into a suitable AC power outlet.
- 4 If the AC power outlet is live, the power indicator light will turn blue.

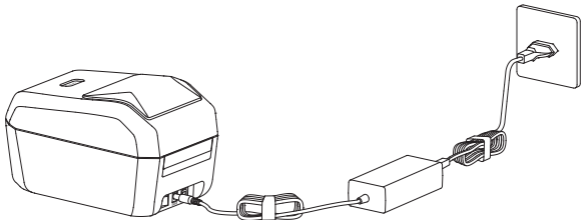

※Attention:

1. Please use the official NIIMBOT power adapter to avoid product damage or potential hazards.
2. If the printer will not be used for an extended period, unplug the power cord from the printer.

## 02-2 Label Paper Installation

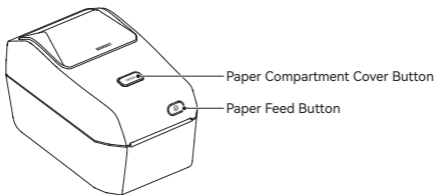

- 1 Facing the front of the device, press the open compartment button to lift the popped-up paper compartment cover upwards.

 Attention: Do not touch the paper blade with your fingers to avoid injury!

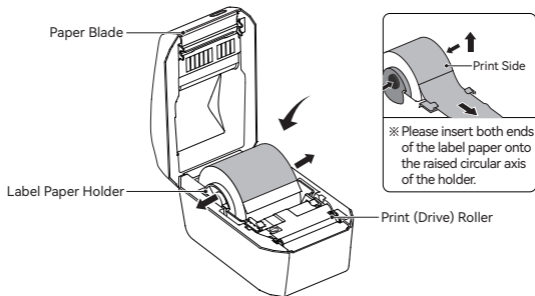



- 2 Open the label paper spool holder, adjust the label paper's orientation so that the print side is facing up when passing through the print (drive) roller. Use your hand to pull the label paper guide open, place the label roll on the label paper spool holder, and release the guide to ensure the label roll can rotate freely.

 Attention: Do not place the label roll at the bottom of the paper compartment.

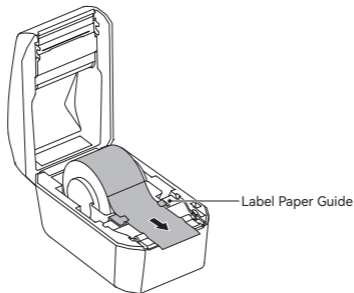

- 3 Thread the label paper through the label paper guide.

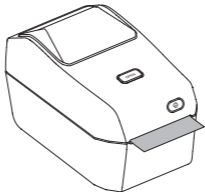

- 4 Close the printer's paper compartment cover, press it down, and listen for a "click" sound, indicating that the paper compartment cover is locked.

※Attention:

1. Failure to thread the label paper through the label paper guide may result in offset printing.
2. If the label paper is not pulled out of the printer, it may cause paper feed issues and printing malfunction.

## 02-3 Software Download

### 01.Download the “NIIMBOT” Desktop Version

You can download and install "NIIMBOT" Desktop version from our official website ([www.niimbot.com](http://www.niimbot.com)).

※ Note: If you need to connect the device to your computer, please use the official-provided data cable or a data cable that supports data transfer.

### 02.Download the NIIMBOT APP

Before using the printer, please install the NIIMBOT app from Google Play or the App Store.



**NIIMBOT**  
Design & Print APP  
easy to download and use



※ More information available on the NIIMBOT app.

Sign in to NIIMBOT

▶ Me

▶ Help Center

▶ Hardware

## 02-4 Communication Connection

### 01.USB Connection

- 1 This printer supports the following communication interface standard:  
Type-B cable.
- 2 Installation Steps:
  - 1) Turn off the printer (O).
  - 2) Connect the USB data cable to the USB port on the back of the printer and then connect it to the printer.
  - 3) Turn on the printer.

### 02.Bluetooth Connection

- 1 Press the power button to turn on the printer.
- 2 Open the "NIIMBOT" APP.
- 3 Select the printer and follow the on-screen instructions to connect.

### 03.WiFi Connection

- 1 Mobile Device WiFi Connection
  - 1) Turn on the printer.
  - 2) Open the "NIIMBOT" APP.
  - 3) Follow the on-screen instructions to connect.
- 2 Computer Network Setup
  - 1) Turn on the printer.
  - 2) Connect the printer using a USB data cable.
  - 3) Open the "NIIMBOT" computer application.
  - 4) Follow the on-screen instructions to connect.

# 03

## Windows Driver Installation

### 03-1 Driver Download

Visit the official NIIMBOT website ([www.niimbot.com](http://www.niimbot.com)) - Download Center - Third-Party Driver Download page to download the driver installation file.

### 03-2 Driver Installation

- 1 Choose your printer.

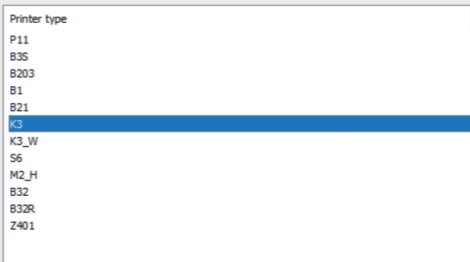

- 2 Select USB as the connection method.

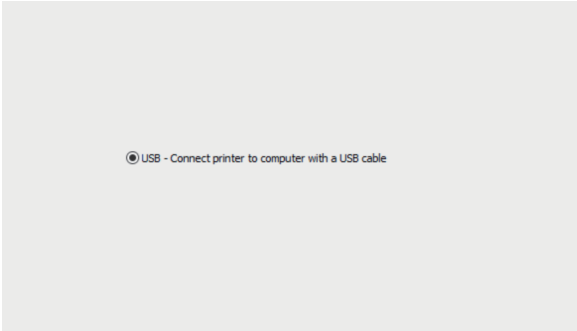

USB - Connect printer to computer with a USB cable

- 3 When you connect your computer to the printer, the USB port will be automatically detected.



USB001 ▾

Search USB

If unsure how to select a USB port, click "Search USB."

- ④ The installation is complete.

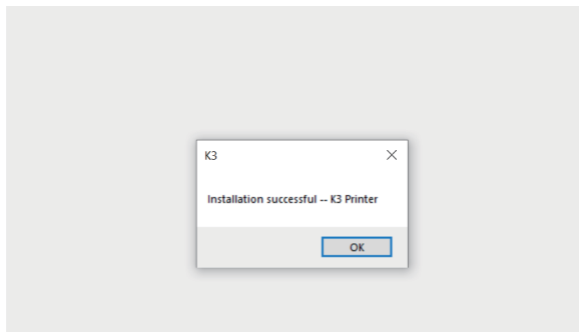

# 04

## Printer Maintenance

Regular maintenance is essential to keep your printer functioning and producing high-quality labels.

※ Attention: Before cleaning the printer, make sure to turn off the power and unplug it.

### 04-1 External Cleaning

Use a soft, dry cloth to wipe off dust and stains from the main unit. For stubborn stains, lightly dampen the cloth with water.

※ Attention: Do not use paint thinner, benzene, alcohol, or any other organic solvents, as they may cause deformation or damage to the printer's casing.

### 04-2 Cleaning the Print Head

- 1 Make sure to turn off the printer before cleaning.
  - 2 Use a cleaning pen to wipe the black area of the print head. Wipe from the center towards the outer edges to remove adhesive transferred from the print head's edges to the outside of the label paper path.
  - 3 After cleaning, let the printer dry for one minute before closing the cover.
- ※ Caution: The print head generates high temperatures during printing. To prevent damage to the print head and the risk of personal injury, do not touch the print head.

ESD Warning: Follow anti-static precautions when handling the print head and electronic components under the cover to prevent damage from static discharge.

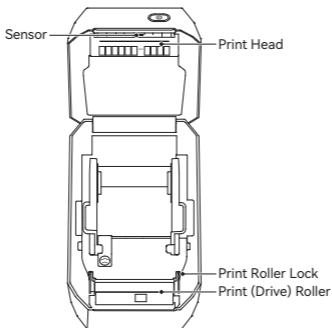

### 04-3 Sensor Cleaning

- 1 Dust can accumulate on the sensors; gently brush it away. Use a dry cotton swab or one dipped in alcohol to remove any adhesive or residues if necessary.
- 2 Use a dry cotton swab to remove remaining residues.
- 3 Repeat steps 1 and 2 as needed until all residues and dirt are gone.
- 4 After cleaning, let the printer dry for one minute, then close the cover or load labels.



#### 04-4 Print Roller Cleaning and Replacement

- 1 Open the cover and remove the label paper.
- 2 Pull the print roller bearings on the left and right sides of the front of the printer towards you, release the wings, and rotate them upward.

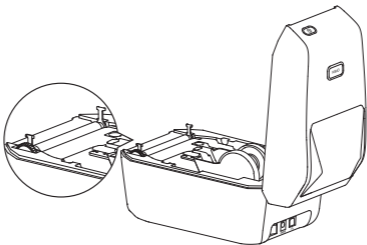

- 3 Lift the print roller out of the printer's bottom bracket.

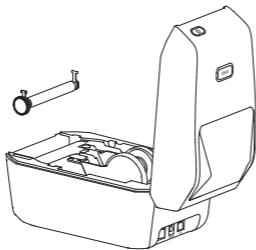

- 4 Clean the print roller with an alcohol-dipped swab or a lint-free cloth, moving from the center outwards. Repeat as needed until the roller is clean. For stubborn substances or label blockages, use a new swab for thorough cleaning.

- 5 Place the print roller back into the printer's bottom bracket.
- 6 Release the wing of the left and right print roller bearings, rotate them downward to the back of the printer, and secure them in place.
- 7 Let the printer dry for a minute, then close the cover or load labels.

# 05

## Troubleshooting

### 01.Indicator Light Red Steady

| Possible Cause                                      | Solution   |
|---|--|
| Cover not closed                                    | Check and close the cover.   |
| No labels   | Insert label paper; refer to label paper installation.                         |
| Label paper not pulled out of the paper compartment | Pull out the label paper from the compartment and close the compartment cover. |
| Print head temperature too high                     | Stop printing and resume printing after the print head has cooled down.        |
| Printing error                                      | Follow the prompts on the application.   |

### 02.Follow the prompts on the application.

| Possible Cause                             | Solution  |
|--|---|
| Printer not powered on                     | Connect the power and turn on the power button. |
| Device connections have exceeded the limit | Device connections have exceeded the limit.     |
| Bluetooth is not enabled on your phone     | Bluetooth is not enabled on your phone.         |

### 03.USB cannot detect the printer

| Possible Cause          | Solution  |
|-------------------------|---|
| Printer not powered on  | Connect the power and turn on the power button. |
| USB Cable not connected | Refer to the “USB Connection” Section.          |

### 04.WiFi cannot detect the printer

| Possible Cause   | Solution  |
|--|---|
| Printer not powered on   | Connect the power and turn on the power button.                                 |
| Incorrect printer model  | WiFi functionality is limited to K3_W only.                                     |
| Printer is not connected to the network                            | Refer to the “WiFi Connection” Section.   |
| Printer and the application are not in the same local area network | Ensure that the printer and the application are on the same local area network. |

### 05.Printer Doesn't Print or Stops Printing

| Possible Cause         | Solution   |
|------------------------|--|
| Printer not powered on | If the printer status light is not on, check and ensure the power cable is properly connected.       |
| Paper feed issue       | Refer to “Paper Feed Issues with Label Paper”.   |
| USB cable is loose     | Make sure the USB cable at the back of the printer or the computer is not loose                      |
| Bluetooth disconnected | Make sure that the Bluetooth connection between the application and the printer is working properly. |
| WiFi disconnected      | Make sure that the WiFi connection between the application and the printer is working properly       |

## 06.Unclear Printing

| Possible Cause                   | Solution  |
|----------------------------------|---|
| Incorrect print density setting  | Adjust the print density.   |
| Dirty print head                 | Refer to the “Cleaning the Print Head” Section and clean the print head   |
| Dirty or damaged print roller    | Clean or replace the print roller; refer to print roller cleaning and replacement. To purchase consumables, contact the customer service.                               |
| Worn-out print head              | Please contact customer service to replace the print head.  |
| Non-official NIIMBOT label paper | This device has RFID reading functionality. If the RFID antenna of the device fails to recognize the information on the label paper, it may result in unclear printing. |

## 07.No print content on the label

| Possible Cause                     | Solution  |
|------------------------------------|---|
| Non-thermal label paper            | Please use thermal label paper.   |
| Incorrect label paper installation | The print surface of the label paper must face up towards the print head; refer to label paper installation for guidance. |

## 08.Paper Feed Issues with Label Paper

| Possible Cause                     | Solution   |
|------------------------------------|--|
| Incorrect label paper installation | Incorrect label paper installation.  |
| Paper Jam                          | Open the cover, pull out the jammed paper from the print rollers, and reposition it.   |
| Out of label paper                 | Please replace the label paper.  |
| Incorrect label type setting       | Ensure the label paper type selected in the application matches the actual label type. |

# 06

## Product Specifications

| Specification Items |                          | NIIMBOT K3_W    |
|---------------------|--------------------------|-----------------|
| Size                | Dimensions               | 232*145*148mm   |
|                     | Weight                   | 1.2KG           |
| Printing            | Print Method             | Thermal         |
|                     | Resolution               | 203dpi          |
|                     | Print Speed              | Max 180mm/s     |
|                     | Effective Printing Width | 80mm            |
|                     | Print Length             | 15mm-300mm      |
|                     | Print Head Lifespan      | 80km            |
| Connection          | Bluetooth                | Support         |
|                     | USB                      | USB Type-B      |
|                     | WiFi                     | Support 2.4G    |
| Power               | Adapter                  | 24V /2.5A       |
| Consumable          | Types                    | Die-Cut Labels  |
|                     | Width                    | 20mm - 82mm     |
|                     | Length                   | 15mm - 300mm    |
|                     | Thickness                | 0.08mm - 0.20mm |

| Specification Items       |                             | NIIMBOT K3_W  |
|---------------------------|-----------------------------|---|
| Consumable                | Paper Roller Inner Diameter | max 105mm   |
|                           | Core Inner Diameter         | 25.4mm 、 40mm   |
| Programing Languages      |                             | CPCL/NIIMBOT Protocol   |
| Software                  | Label Design                | NIIMBOT(APP & PC)   |
|                           | Drive                       | Win7 /10/11   |
| Built-in Fonts            |                             | Chinese GB18030 16x16 dot matrix, 24x24 dot matrix            |
|                           |                             | English ASCII 8x16 dot matrix, 12x24 dot matrix               |
| Barcodes                  | 1D                          | UPC-A、UPC-C、EAN13、EAN8、code 39、code 93、I2OF5、code 128、codabar |
|                           | 2D                          | PDF-417、QR code   |
| Human-Machine Interaction | Power Switch                | Boat-Type Power Switch  |
|                           | Button                      | Paper Feed Button   |
|                           | Indicator Lights            | Red/Green/Blue/white  |
| Environmental Parameters  | Working                     | 0°C to 40°C, 10% to 85%, non-condensing                       |
|                           | Storage                     | -10°C to -60°C, 10% to 90%, non-condensing                    |

# 07

## Label Paper

It is recommended to use official, genuine consumables from NIIMBOT for consistent high-quality printing results. Specially designed label products can enhance the printer's performance and prevent premature wear and tear of the print head.

### 01. Confirming Label Material

- ❶ For regular thermal label paper, you can use your fingernail or a pen cap to scratch the printing surface.
- ❷ NIIMBOT's official, genuine thermal label paper enhances durability and water resistance; it requires a lighter or heat source for baking.
- ❸ Check if there are black marks on the label paper.
  - ※ 1. If black markings appear on the medium, the label material is thermal sensitive, which this printer supports.
  - 2. If black markings do not appear on the medium, the label material is thermal transfer, and it requires the use of a ribbon. This printer does not support this type.

### 02. Label Types

| Label Types                 | Paper Feed Types | Description   |
|-----------------------------|------------------|---|
| Non-Continuous Rolled Label | Gap              | Each label is separated by a gap.   |
|                             | Black Mark       | The separation of labels is indicated by a pre-printed black mark on the back of the label. |
|                             | Transparent      | Labels are made of transparent material, separated by gaps.                                 |



# 08

## Related Statements

### FCC Statement

This device complies with part 15 of the FCC Rules. Operation is subject to the following two conditions: (1) this device may not cause harmful interference, and (2) this device must accept any interference received, including interference that may cause undesired operation.

Any changes or modifications not expressly approved by the party responsible for compliance could void the user's authority to operate the equipment.

NOTE: This equipment has been tested and found to comply with the limits for a Class B digital device, pursuant to Part 15 of the FCC Rules. These limits are designed to provide reasonable protection against harmful interference in a residential installation. This equipment generates, uses and can radiate radio frequency energy and, if not installed and used in accordance with the instructions, may cause harmful interference to radio communications.

However, there is no guarantee that interference will not occur in a particular installation. If this equipment does cause harmful interference to radio or television reception, which can be determined by turning the equipment off and on, the user is encouraged to try to correct the interference by one or more of the following measures:

- Reorient or relocate the receiving antenna.
- Increase the separation between the equipment and receiver.

-- Connect the equipment into an outlet on a circuit different from that to which the receiver is connected.

-- Consult the dealer or an experienced radio/TV technician for help.

The device has been evaluated to meet general RF exposure requirement. The device shall be installed and operated with minimum distance 20cm between the radiator & body.

## **Declaration of conformity**

Hereby, Wuhan Jingchen Intelligent Identification Technology Co., Ltd. declares that this device is in compliance with the essential requirements and other relevant provisions of Radio Equipment Directive (RED) 2014/53/EU. This product can be used across EU member states. This device can be used in European Union. Hereby, [Wuhan Jingchen Intelligent Identification Technology Co., Ltd.] declares that the radio equipment type [NIIMBOT K3\_W] is in compliance with Directive 2014/53/EU.

The full text of the EU declaration of conformity is available at the following internet address: <http://www.niimbot.com>.

