

---

# FCC Test Report

---

Report No.: AGC07434220704FE03

**FCC ID** : 2ARXB-B1A

**APPLICATION PURPOSE** : Original Equipment

**PRODUCT DESIGNATION** : Label Printer

**BRAND NAME** : NIIMBOT

**MODEL NAME** : NIIMBOT B1, B1 Pro, B1 SE

**APPLICANT** : Wuhan Jingchen Intelligent Identification Technology Co., Ltd.

**DATE OF ISSUE** : Aug. 26, 2022

**STANDARD(S)** : FCC Part 15.247

**REPORT VERSION** : V1.0

Attestation of Global Compliance (Shenzhen) Co., Ltd



Any report having not been signed by authorized approver, or having been altered without authorization, or having not been stamped by the "Dedicated Testing/Inspection Stamp" is deemed to be invalid. Copying or excerpting portion of, or altering the content of the report is not permitted without the written authorization of AGC. The test results presented in the report apply only to the tested sample. Any objections to report issued by AGC should be submitted to AGC within 15days after the issuance of the test report. Further enquiry of validity or verification of the test report should be addressed to AGC by [agc01@agccert.com](mailto:agc01@agccert.com).

Attestation of Global Compliance(Shenzhen)Co., Ltd  
Attestation of Global Compliance(Shenzhen)Std & Tech Co., Ltd  
Tel: +86-755 2523 4088 E-mail: [agc@agccert.com](mailto:agc@agccert.com) Web: <http://www.agccert.com/>



**REPORT REVISE RECORD**

Report Version	Revise Time	Issued Date	Valid Version	Notes
V1.0	/	Aug. 26, 2022	Valid	Initial Release

Any report having not been signed by authorized approver, or having been altered without authorization, or having not been stamped by the "Dedicated Testing/Inspection Stamp" is deemed to be invalid. Copying or excerpting portion of, or altering the content of the report is not permitted without the written authorization of AGC. The test results presented in the report apply only to the tested sample. Any objections to report issued by AGC should be submitted to AGC within 15days after the issuance of the test report. Further enquiry of validity or verification of the test report should be addressed to AGC by [agc01@agccert.com](mailto:agc01@agccert.com).

## TABLE OF CONTENTS

<b>1. VERIFICATION OF CONFORMITY</b> .....	<b>5</b>
<b>2. GENERAL INFORMATION</b> .....	<b>6</b>
2.1. PRODUCT DESCRIPTION .....	6
2.2. TABLE OF CARRIER FREQUENCIES .....	6
2.3. RECEIVER INPUT BANDWIDTH .....	7
2.4. EXAMPLE OF A HOPPING SEQUENCY IN DATA MODE .....	7
2.5. EQUALLY AVERAGE USE OF FREQUENCIES AND BEHAVIOUR .....	7
2.6. RELATED SUBMITTAL(S) / GRANT (S) .....	8
2.7. TEST METHODOLOGY .....	8
2.8. SPECIAL ACCESSORIES .....	8
2.9. EQUIPMENT MODIFICATIONS.....	8
2.10. ANTENNA REQUIREMENT.....	8
<b>3. MEASUREMENT UNCERTAINTY</b> .....	<b>9</b>
<b>4. DESCRIPTION OF TEST MODES</b> .....	<b>10</b>
<b>5. SYSTEM TEST CONFIGURATION</b> .....	<b>11</b>
5.1. CONFIGURATION OF EUT SYSTEM.....	11
5.2. EQUIPMENT USED IN TESTED SYSTEM.....	11
5.3. SUMMARY OF TEST RESULTS .....	11
<b>6. TEST FACILITY</b> .....	<b>12</b>
<b>7. PEAK OUTPUT POWER</b> .....	<b>13</b>
7.1. MEASUREMENT PROCEDURE .....	13
7.2. TEST SET-UP (BLOCK DIAGRAM OF CONFIGURATION) .....	13
7.3. LIMITS AND MEASUREMENT RESULT .....	14
<b>8. 20DB BANDWIDTH</b> .....	<b>16</b>
8.1. MEASUREMENT PROCEDURE .....	16
8.2. TEST SET-UP (BLOCK DIAGRAM OF CONFIGURATION) .....	16
8.3. LIMITS AND MEASUREMENT RESULTS .....	17
<b>9. CONDUCTED SPURIOUS EMISSION</b> .....	<b>19</b>
9.1. MEASUREMENT PROCEDURE .....	19

Any report having not been signed by authorized approver, or having been altered without authorization, or having not been stamped by the “Dedicated Testing/Inspection Stamp” is deemed to be invalid. Copying or excerpting portion of, or altering the content of the report is not permitted without the written authorization of AGC. The test results presented in the report apply only to the tested sample. Any objections to report issued by AGC should be submitted to AGC within 15days after the issuance of the test report. Further enquiry of validity or verification of the test report should be addressed to AGC by [agc01@agccert.com](mailto:agc01@agccert.com).

9.2. TEST SET-UP (BLOCK DIAGRAM OF CONFIGURATION) .....	19
9.3. MEASUREMENT EQUIPMENT USED .....	19
9.4. LIMITS AND MEASUREMENT RESULT .....	19
<b>10. RADIATED EMISSION .....</b>	<b>27</b>
10.1. MEASUREMENT PROCEDURE .....	27
10.2. TEST SETUP .....	29
10.3. LIMITS AND MEASUREMENT RESULT .....	30
10.4. TEST RESULT.....	30
<b>11. NUMBER OF HOPPING FREQUENCY .....</b>	<b>40</b>
11.1. MEASUREMENT PROCEDURE.....	40
11.2. TEST SETUP (BLOCK DIAGRAM OF CONFIGURATION) .....	40
11.3. MEASUREMENT EQUIPMENT USED .....	40
11.4. LIMITS AND MEASUREMENT RESULT .....	40
<b>12. TIME OF OCCUPANCY (DWELL TIME).....</b>	<b>41</b>
12.1. MEASUREMENT PROCEDURE .....	41
12.2. TEST SETUP (BLOCK DIAGRAM OF CONFIGURATION) .....	41
12.3. MEASUREMENT EQUIPMENT USED .....	41
12.4. LIMITS AND MEASUREMENT RESULT .....	41
<b>13. FREQUENCY SEPARATION .....</b>	<b>45</b>
13.1. MEASUREMENT PROCEDURE .....	45
13.2. TEST SETUP (BLOCK DIAGRAM OF CONFIGURATION) .....	45
13.3. MEASUREMENT EQUIPMENT USED .....	45
13.4. LIMITS AND MEASUREMENT RESULT .....	45
<b>14. LINE CONDUCTED EMISSION TEST .....</b>	<b>46</b>
14.1. LIMITS OF LINE CONDUCTED EMISSION TEST .....	46
14.2. BLOCK DIAGRAM OF LINE CONDUCTED EMISSION TEST.....	46
14.3. PRELIMINARY PROCEDURE OF LINE CONDUCTED EMISSION TEST .....	47
14.4. FINAL PROCEDURE OF LINE CONDUCTED EMISSION TEST.....	47
14.5. TEST RESULT OF LINE CONDUCTED EMISSION TEST .....	48
<b>APPENDIX A: PHOTOGRAPHS OF TEST SETUP .....</b>	<b>50</b>
<b>APPENDIX B: PHOTOGRAPHS OF EUT .....</b>	<b>50</b>

Any report having not been signed by authorized approver, or having been altered without authorization, or having not been stamped by the “Dedicated Testing/Inspection Stamp” is deemed to be invalid. Copying or excerpting portion of, or altering the content of the report is not permitted without the written authorization of AGC. The test results presented in the report apply only to the tested sample. Any objections to report issued by AGC should be submitted to AGC within 15days after the issuance of the test report. Further enquiry of validity or verification of the test report should be addressed to AGC by [agc01@agccert.com](mailto:agc01@agccert.com).

## 1. VERIFICATION OF CONFORMITY

<b>Applicant</b>	Wuhan Jingchen Intelligent Identification Technology Co., Ltd.
<b>Address</b>	Creative Workshop No. 5, Creative World, Yezhihu West Road, Hongshan District, Wuhan, China
<b>Manufacturer</b>	Wuhan Jingchen Intelligent Identification Technology Co., Ltd.
<b>Address</b>	Creative Workshop No. 5, Creative World, Yezhihu West Road, Hongshan District, Wuhan, China
<b>Factory</b>	Huangpi branch of Wuhan Jingchen Intelligent Identification Technology Co., Ltd.
<b>Address</b>	4th Floor, Block 6, Hui Qiang Technology Park, No. 1 Tianyang Road, Chuanlong Av.Hengdian street, Huangpi District, Wuhan, China
<b>Product Designation</b>	Label Printer
<b>Brand Name</b>	NIIMBOT
<b>Test Model</b>	NIIMBOT B1
<b>Series Model</b>	B1 Pro, B1 SE
<b>Declaration of Difference</b>	All the same except for the model name and appearance color
<b>Date of test</b>	Jul. 18, 2022 to Aug. 26, 2022
<b>Deviation</b>	No any deviation from the test method
<b>Condition of Test Sample</b>	Normal
<b>Test Result</b>	Pass
<b>Report Template</b>	AGCRT-US-BR/RF

We hereby certify that:

The above equipment was tested by Attestation of Global Compliance (Shenzhen) Co., Ltd. The test data, data evaluation, test procedures, and equipment configurations shown in this report were made in accordance with the procedures given in ANSI C63.10 (2013) and the energy emitted by the sample EUT tested as described in this report is in compliance with radiated emission limits of FCC PART 15.247.

Prepared By



Cool Cheng  
(Project Engineer)

Aug. 26, 2022

Reviewed By



Calvin Liu  
(Reviewer)

Aug. 26, 2022

Approved By



Max Zhang  
(Authorized Officer)

Aug. 26, 2022

Any report having not been signed by authorized approver, or having been altered without authorization, or having not been stamped by the "Dedicated Testing/Inspection Stamp" is deemed to be invalid. Copying or excerpting portion of, or altering the content of the report is not permitted without the written authorization of AGC. The test results presented in the report apply only to the tested sample. Any objections to report issued by AGC should be submitted to AGC within 15days after the issuance of the test report. Further enquiry of validity or verification of the test report should be addressed to AGC by agc01@agccert.com.

Attestation of Global Compliance(Shenzhen)Co., Ltd

Attestation of Global Compliance(Shenzhen)Std & Tech Co., Ltd

Tel: +86-755 2523 4088 E-mail: agc@agccert.com Web: http://www.agccert.com/

## 2. GENERAL INFORMATION

### 2.1. PRODUCT DESCRIPTION

The EUT is designed as “Label Printer”. It is designed by way of utilizing the GFSK technology to achieve the system operation.

A major technical description of EUT is described as following

<b>Operation Frequency</b>	2.402GHz to 2.480GHz
<b>RF Output Power</b>	0.826dBm (Max)
<b>Bluetooth Version</b>	V5.2
<b>Modulation</b>	BR <input checked="" type="checkbox"/> GFSK, EDR <input type="checkbox"/> π /4-DQPSK, <input type="checkbox"/> 8DPSK BLE <input type="checkbox"/> GFSK 1Mbps <input type="checkbox"/> GFSK 2Mbps
<b>Number of channels</b>	79 Channels
<b>Hardware Version</b>	B1-Main-YC3121-L-YC5018-B
<b>Software Version</b>	V3.01
<b>Antenna Designation</b>	PCB Antenna (Comply with requirements of the FCC part 15.203)
<b>Antenna Gain</b>	2.323dBi
<b>Power Supply</b>	DC 7.4V by battery or DC 5V by adapter
Note: The EUT has two battery. One is battery(JL-B201) and battery(BL-2S1P18650), Except for the different manufacturers, the other parameters of the two batteries are the same. Both have been assessed, Only the test data by battery (JL-B201) recorded in this report.	

### 2.2. TABLE OF CARRIER FREQUENCIES

Frequency Band	Channel Number	Frequency
2402~2480MHz	0	2402 MHz
	1	2403 MHz
	:	:
	38	2440 MHz
	39	2441 MHz
	40	2442 MHz
	:	:
	77	2479 MHz
	78	2480 MHz

Any report having not been signed by authorized approver, or having been altered without authorization, or having not been stamped by the “Dedicated Testing/Inspection Stamp” is deemed to be invalid. Copying or excerpting portion of, or altering the content of the report is not permitted without the written authorization of AGC. The test results presented in the report apply only to the tested sample. Any objections to report issued by AGC should be submitted to AGC within 15days after the issuance of the test report. Further enquiry of validity or verification of the test report should be addressed to AGC by agc01@agccert.com.

### 2.3. RECEIVER INPUT BANDWIDTH

The input bandwidth of the receiver is 1.3MHz, in every connection one Bluetooth device is the master and the other one is slave. The master determines the hopping sequence. The slave follows this sequence. Both devices shift between RX and TX time slot according to the clock of the master. Additionally, the type of connection (e.g. single or multi slot packet) is set up at the beginning of the connection. The master adapts its hopping frequency and its TX/RX timing according to the packet type of the connection. Also, the slave of the connection will use these settings. Repeating of a packet has no influence on the hopping sequence. The hopping sequence generated by the master of the connection will be followed in any case. That means, a repeated packet will not be send on the same frequency, it is send on the next frequency of the hopping sequence.

### 2.4. EXAMPLE OF A HOPPING SEQUENCY IN DATA MODE

Example of a hopping sequence in data mode:

40, 21, 44, 23, 04, 15, 66, 56, 19, 78, 07, 28, 69, 55,  
36, 45, 05, 13, 43, 74, 57, 35, 67, 76, 02, 34, 54, 63,  
42, 11, 30, 06, 64, 25, 75, 48, 17, 33, 58, 01, 29, 14,  
51, 72, 03, 31, 50, 61, 77, 18, 10, 47, 12, 68, 08, 49,  
20, 00, 73, 09, 16, 60, 71, 41, 24, 53, 38, 26, 46, 37,  
65, 32, 70, 52, 27, 59, 22, 62, 39

### 2.5. EQUALLY AVERAGE USE OF FREQUENCIES AND BEHAVIOUR

The generation of the hopping sequence in connection mode depends essentially on two input values:

1. LAP/UAP of the master of the connection.
2. Internal master clock.

The LAP (lower address part) are the 24 LSB's of the 48 BD\_ADDRESS. The BD\_ADDRESS is an unambiguous number of every Bluetooth unit. The UAP (upper address part) are the 24MSB's of the 48BD\_ADDRESS

The internal clock of a Bluetooth unit is derived from a free running clock which is never adjusted and is never turned off. For behavior action with other units only offset is used. It has no relation to the time of the day. Its resolution is at least half the RX/TX slot length of 312.5us. The clock has a cycle of about one day(23h30). In most case it is implemented as 28 bits counter. For the deriving of the hopping sequence the entire. LAP (24 bits),4LSB's(4bits) (Input 1) and the 27MSB's of the clock (Input 2) are used. With this input values different mathematical procedures (permutations, additions, XOR-operations) are performed to generate the Sequence. This will be done at the beginning of every new transmission.

Regarding short transmissions the Bluetooth system has the following behavior:

The first connection between the two devices is established, a hopping sequence was generated. For Transmitting the wanted data the complete hopping sequence was not used. The connection ended.



The second connection will be established. A new hopping sequence is generated. Due to the fact the Bluetooth clock has a different value, because the period between the two transmission is longer (and it cannot be shorter) than the minimum resolution of the clock(312.5us). The hopping sequence will always differ from the first one.

## **2.6. RELATED SUBMITTAL(S) / GRANT (S)**

This submittal(s) (test report) is intended for **FCC ID: 2ARXB-B1A** filing to comply with the FCC PART 15.247 requirements.

## **2.7. TEST METHODOLOGY**

Both conducted and radiated testing was performed according to the procedures in ANSI C63.10 (2013). Radiated testing was performed at an antenna to EUT distance 3 meters.

## **2.8. SPECIAL ACCESSORIES**

Refer to section 5.2.

## **2.9. EQUIPMENT MODIFICATIONS**

Not available for this EUT intended for grant.

## **2.10. ANTENNA REQUIREMENT**

This intentional radiator is designed with a permanently attached antenna of an antenna to ensure that no antenna other than that furnished by the responsible party shall be used with the device.

For more information of the antenna, please refer to the APPENDIX B: PHOTOGRAPHS OF EUT.



### 3. MEASUREMENT UNCERTAINTY

The reported uncertainty of measurement  $y \pm U$ , where expanded uncertainty  $U$  is based on a standard uncertainty multiplied by a coverage factor of  $k=2$ , providing a level of confidence of approximately 95%.

Item	Measurement Uncertainty
Uncertainty of Conducted Emission for AC Port	$U_c = \pm 2.9$ dB
Uncertainty of Radiated Emission below 1GHz	$U_c = \pm 3.8$ dB
Uncertainty of Radiated Emission above 1GHz	$U_c = \pm 4.9$ dB
Uncertainty of total RF power, conducted	$U_c = \pm 0.8$ dB
Uncertainty of RF power density, conducted	$U_c = \pm 2.6$ dB
Uncertainty of spurious emissions, conducted	$U_c = \pm 2$ %
Uncertainty of Occupied Channel Bandwidth	$U_c = \pm 2$ %

Any report having not been signed by authorized approver, or having been altered without authorization, or having not been stamped by the "Dedicated Testing/Inspection Stamp" is deemed to be invalid. Copying or excerpting portion of, or altering the content of the report is not permitted without the written authorization of AGC. The test results presented in the report apply only to the tested sample. Any objections to report issued by AGC should be submitted to AGC within 15days after the issuance of the test report. Further enquiry of validity or verification of the test report should be addressed to AGC by [agc01@agccert.com](mailto:agc01@agccert.com).

#### 4. DESCRIPTION OF TEST MODES

NO.	TEST MODE DESCRIPTION
1	Low channel GFSK
2	Middle channel GFSK
3	High channel GFSK
4	Hopping mode GFSK

- Note: 1. Only the result of the worst case was recorded in the report, if no other cases.  
 2. For Radiated Emission, 3axis were chosen for testing for each applicable mode.  
 3. For Conducted Test method, a temporary antenna connector is provided by the manufacture.

#### Software Setting

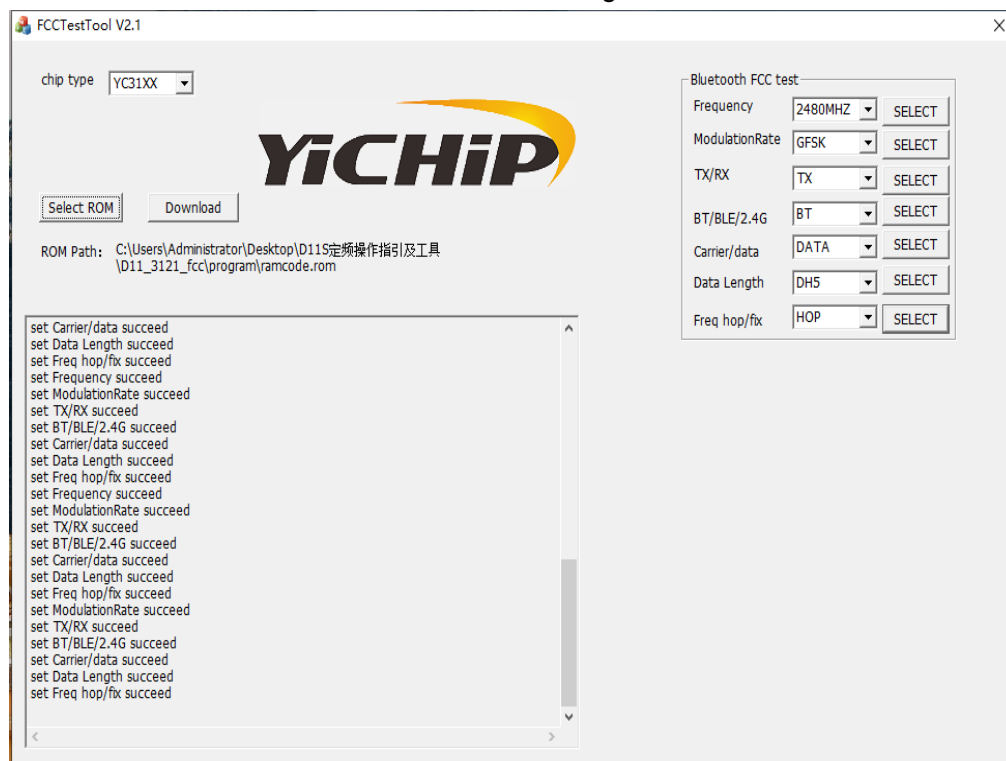

Any report having not been signed by authorized approver, or having been altered without authorization, or having not been stamped by the “Dedicated Testing/Inspection Stamp” is deemed to be invalid. Copying or excerpting portion of, or altering the content of the report is not permitted without the written authorization of AGC. The test results presented in the report apply only to the tested sample. Any objections to report issued by AGC should be submitted to AGC within 15days after the issuance of the test report. Further enquiry of validity or verification of the test report should be addressed to AGC by agc01@agccert.com.

## 5. SYSTEM TEST CONFIGURATION

### 5.1. CONFIGURATION OF EUT SYSTEM

Radiated Emission Configure:



Conducted Emission Configure:

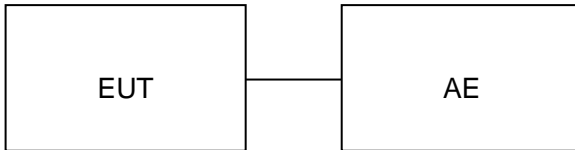

### 5.2. EQUIPMENT USED IN TESTED SYSTEM

Item	Equipment	Model No.	ID or Specification	Remark
1	Label Printer	NIIMBOT B1	2ARXB-B1A	EUT
2	Control Box	USB-TTL	N/A	AE
3	Charger line	N/A	0.245m unshielded	Accessory
4	Adapter	XCMS03-0510	DC 5V	AE

### 5.3. SUMMARY OF TEST RESULTS

FCC RULES	DESCRIPTION OF TEST	RESULT
15.247 (b)(1)	Peak Output Power	Compliant
15.247 (a)(1)	20 dB Bandwidth	Compliant
15.247 (d)	Conducted Spurious Emission	Compliant
15.209	Radiated Emission	Compliant
15.247 (a)(1)(iii)	Number of Hopping Frequency	Compliant
15.247 (a)(1)(iii)	Time of Occupancy	Compliant
15.247 (a)(1)	Frequency Separation	Compliant
15.207	Conducted Emission	Compliant

Any report having not been signed by authorized approver, or having been altered without authorization, or having not been stamped by the "Dedicated Testing/Inspection Stamp" is deemed to be invalid. Copying or excerpting portion of, or altering the content of the report is not permitted without the written authorization of AGC. The test results presented in the report apply only to the tested sample. Any objections to report issued by AGC should be submitted to AGC within 15days after the issuance of the test report. Further enquiry of validity or verification of the test report should be addressed to AGC by [agc01@agccert.com](mailto:agc01@agccert.com).

## 6. TEST FACILITY

<b>Test Site</b>	Attestation of Global Compliance (Shenzhen) Co., Ltd
<b>Location</b>	1-2/F, Building 19, Junfeng Industrial Park, Chongqing Road, Heping Community, Fuhai Street, Bao'an District, Shenzhen, Guangdong, China
<b>Designation Number</b>	CN1259
<b>FCC Test Firm Registration Number</b>	975832
<b>A2LA Cert. No.</b>	5054.02
<b>Description</b>	Attestation of Global Compliance (Shenzhen) Co., Ltd is accredited by A2LA

### TEST EQUIPMENT OF CONDUCTED EMISSION TEST

Equipment	Manufacturer	Model	S/N	Cal. Date	Cal. Due
Test Receiver	R&S	ESPI	101206	Mar. 28, 2022	Mar. 27, 2023
Artificial power network	R&S	ESH2-Z5	100086	Jun. 08, 2022	Jun. 07, 2023
Test Software	FARA	EZ-EMC(Ver. AGC-CON03A1)	N/A	N/A	N/A

### TEST EQUIPMENT OF RADIATED EMISSION TEST

Equipment	Manufacturer	Model	S/N	Cal. Date	Cal. Due
Test Receiver	R&S	ESCI	10096	Mar. 28, 2022	Mar. 27, 2023
EXA Signal Analyzer	Aglient	N9010A	MY53470504	Nov. 17, 2021	Nov. 16, 2022
Signal Analyzer	Aglient	N9020A	MY52090123	Sep. 06, 2021	Sep. 05, 2022
2.4GHz Filter	EM Electronics	N/A	N/A	Mar. 18, 2022	Mar. 19, 2024
Attenuator	ZHINAN	E-002	N/A	Sep. 03, 2020	Sep. 02, 2022
Horn Antenna	SCHWARZBEC	BBHA9170	768	Oct. 31, 2021	Oct. 30, 2023
Active Loop Antenna (9K-30Mhz)	ZHINAN	ZN30900C	18051	Mar. 12, 2022	Mar. 11, 2024
Double-Ridged Waveguide Horn	ETS	3117	00034609	Apr. 23, 2021	Apr. 22, 2023
Preamplifier Assembly	ETS	3117PA	00225134	Sep. 03, 2020	Sep. 02, 2022
Wideband Antenna	SCHWARZBECK	VULB9168	VULB9168-494	Jan. 08, 2021	Jan. 07, 2023
Test Software	FARA	EZ-EMC(Ver.RA-03A)	N/A	N/A	N/A

Any report having not been signed by authorized approver, or having been altered without authorization, or having not been stamped by the "Dedicated Testing/Inspection Stamp" is deemed to be invalid. Copying or excerpting portion of, or altering the content of the report is not permitted without the written authorization of AGC. The test results presented in the report apply only to the tested sample. Any objections to report issued by AGC should be submitted to AGC within 15days after the issuance of the test report. Further enquiry of validity or verification of the test report should be addressed to AGC by agc01@agccert.com.

## 7. PEAK OUTPUT POWER

### 7.1. MEASUREMENT PROCEDURE

For peak power test:

1. Connect EUT RF output port to the Spectrum Analyzer through an RF attenuator
2. Span: Approximately five times the 20 dB bandwidth, centered on a hopping channel.
3. RBW > 20 dB bandwidth of the emission being measured.
4. VBW  $\geq$  RBW.
5. Sweep: Auto.
6. Detector function: Peak.
7. Trace: Max hold.

Allow trace to stabilize. Use the marker-to-peak function to set the marker to the peak of the emission. The indicated level is the peak output power, after any corrections for external attenuators and cables.

### 7.2. TEST SET-UP (BLOCK DIAGRAM OF CONFIGURATION)

#### PEAK POWER TEST SETUP

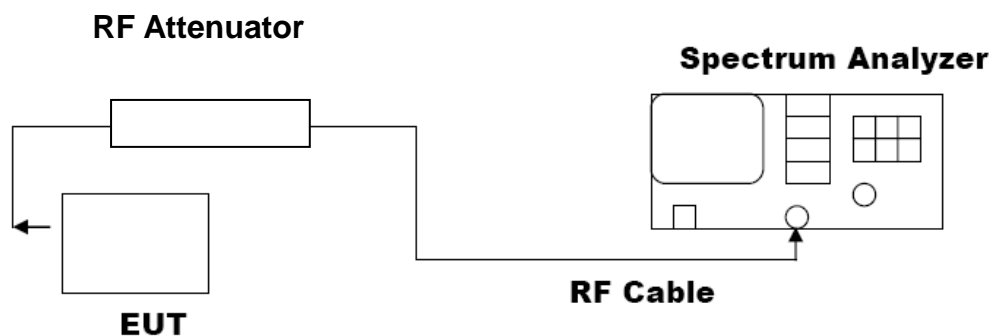

### 7.3. LIMITS AND MEASUREMENT RESULT

Test Data of Conducted Output Power				
Test Mode	Test Channel (MHz)	Peak Power (dBm)	Limits (dBm)	Pass or Fail
GFSK	2402	0.225	≤21	Pass
	2441	0.826	≤21	Pass
	2480	0.717	≤21	Pass

### Test Graphs of Conducted Output Power

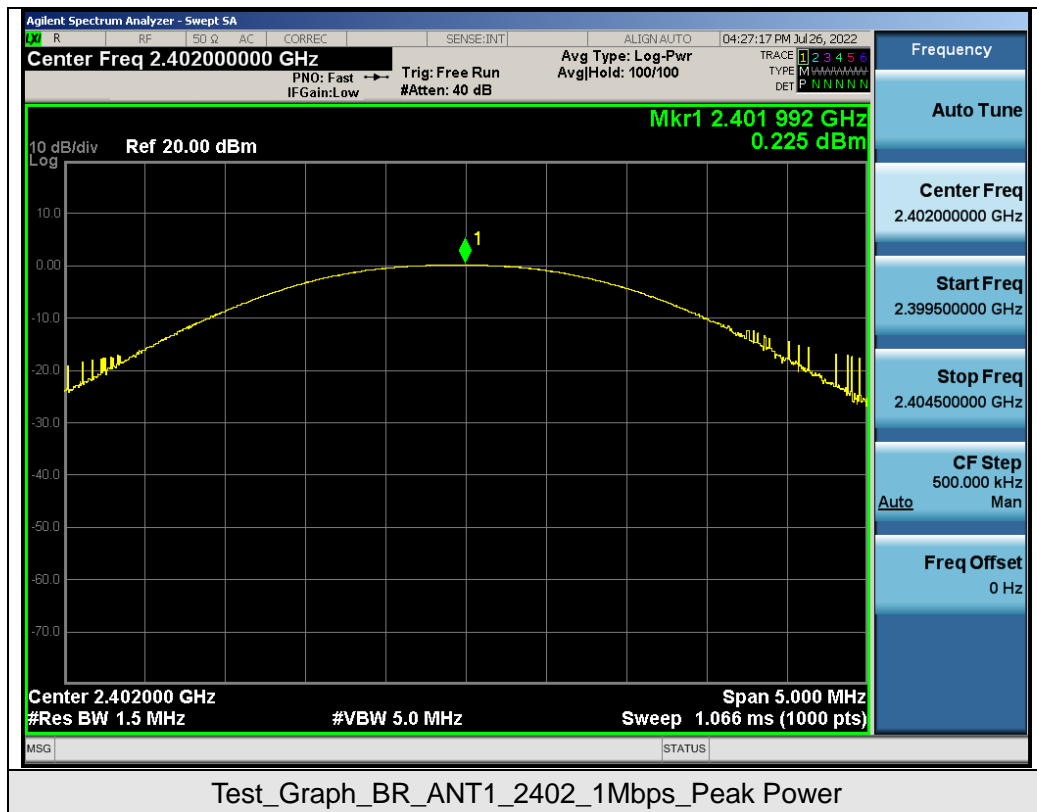

Any report having not been signed by authorized approver, or having been altered without authorization, or having not been stamped by the “Dedicated Testing/Inspection Stamp” is deemed to be invalid. Copying or excerpting portion of, or altering the content of the report is not permitted without the written authorization of AGC. The test results presented in the report apply only to the tested sample. Any objections to report issued by AGC should be submitted to AGC within 15days after the issuance of the test report. Further enquiry of validity or verification of the test report should be addressed to AGC by agc01@agccert.com.

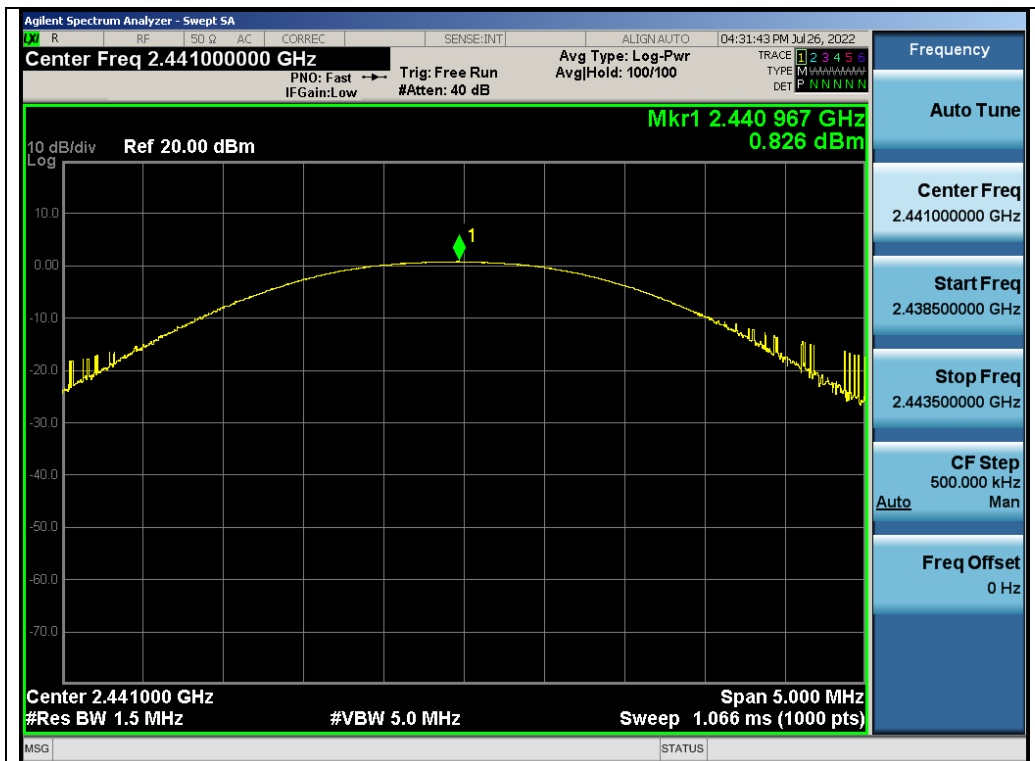

Test\_Graph\_BR\_ANT1\_2441\_1Mbps\_Peak Power

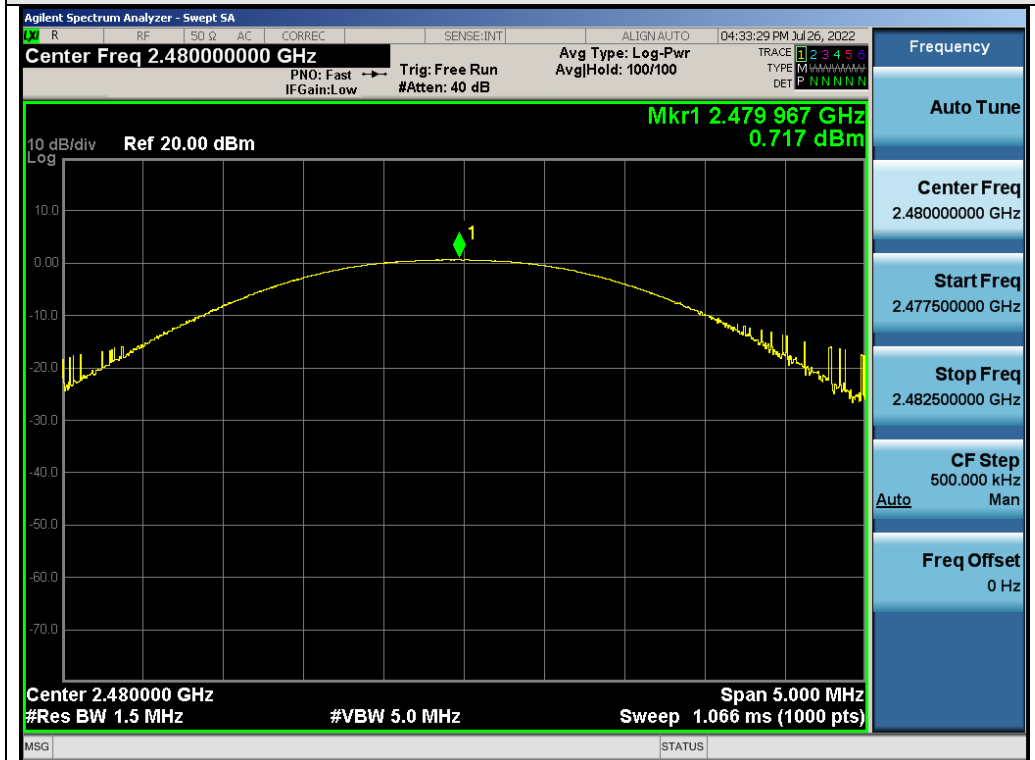

Test\_Graph\_BR\_ANT1\_2480\_1Mbps\_Peak Power

Any report having not been signed by authorized approver, or having been altered without authorization, or having not been stamped by the "Dedicated Testing/Inspection Stamp" is deemed to be invalid. Copying or excerpting portion of, or altering the content of the report is not permitted without the written authorization of AGC. The test results presented in the report apply only to the tested sample. Any objections to report issued by AGC should be submitted to AGC within 15days after the issuance of the test report. Further enquiry of validity or verification of the test report should be addressed to AGC by agc01@agccert.com.



## 8. 20DB BANDWIDTH

### 8.1. MEASUREMENT PROCEDURE

1. Connect EUT RF output port to the Spectrum Analyzer through an RF attenuator
2. Set the EUT Work on the top, the middle and the bottom operation frequency individually.
3. Set Span = approximately 2 to 5 times the 20 dB bandwidth, centered on a hopping channel  
The nominal IF filter bandwidth (3 dB RBW) shall be in the range of 1% to 5% of the OBW and video bandwidth (VBW) shall be approximately three times RBW; Sweep = auto; Detector function = peak
4. Set SPA Trace 1 Max hold, then View.

### 8.2. TEST SET-UP (BLOCK DIAGRAM OF CONFIGURATION)

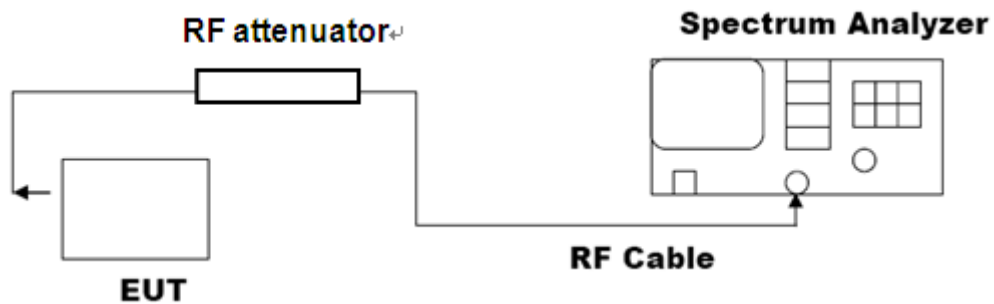

Any report having not been signed by authorized approver, or having been altered without authorization, or having not been stamped by the "Dedicated Testing/Inspection Stamp" is deemed to be invalid. Copying or excerpting portion of, or altering the content of the report is not permitted without the written authorization of AGC. The test results presented in the report apply only to the tested sample. Any objections to report issued by AGC should be submitted to AGC within 15days after the issuance of the test report. Further enquiry of validity or verification of the test report should be addressed to AGC by [agc01@agccert.com](mailto:agc01@agccert.com).

### 8.3. LIMITS AND MEASUREMENT RESULTS

Test Data of Occupied Bandwidth and -20dB Bandwidth					
Test Mode	Test Channel (MHz)	99% Occupied Bandwidth (MHz)	-20dB Bandwidth (MHz)	Limits	Pass or Fail
GFSK	2402	0.934	1.039	N/A	Pass
	2441	0.933	1.034	N/A	Pass
	2480	0.934	1.037	N/A	Pass

### Test Graphs of Occupied Bandwidth and -20 Bandwidth

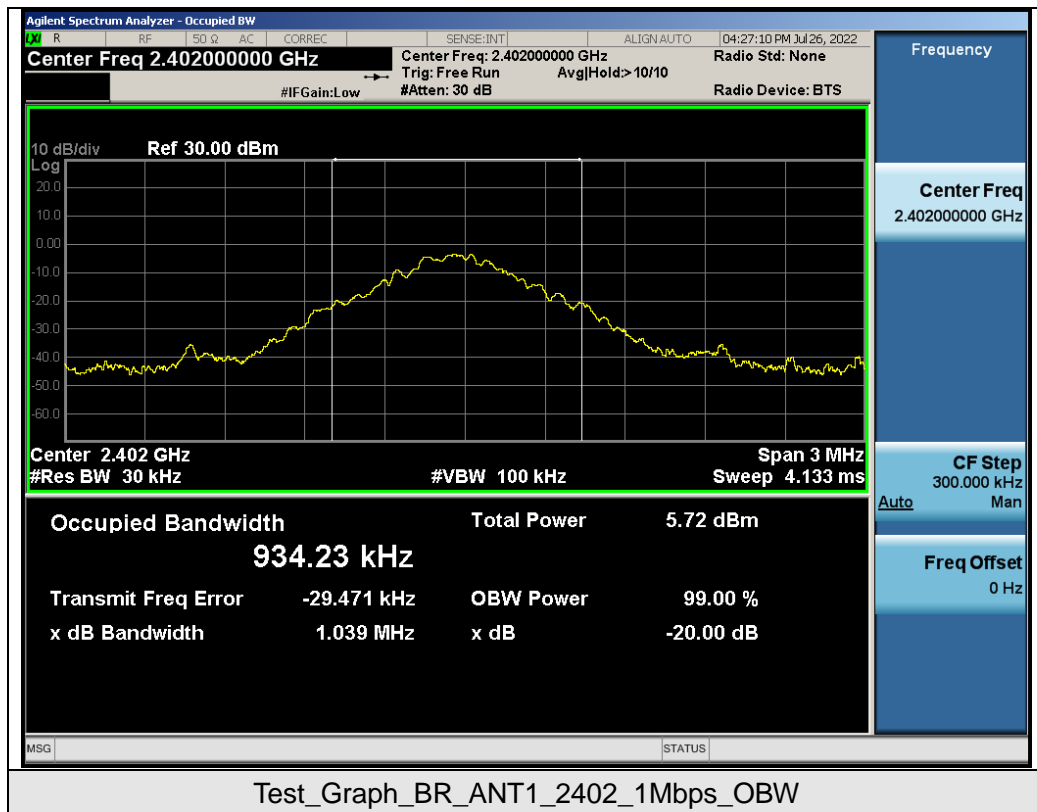

Any report having not been signed by authorized approver, or having been altered without authorization, or having not been stamped by the "Dedicated Testing/Inspection Stamp" is deemed to be invalid. Copying or excerpting portion of, or altering the content of the report is not permitted without the written authorization of AGC. The test results presented in the report apply only to the tested sample. Any objections to report issued by AGC should be submitted to AGC within 15days after the issuance of the test report. Further enquiry of validity or verification of the test report should be addressed to AGC by agc01@agccert.com.

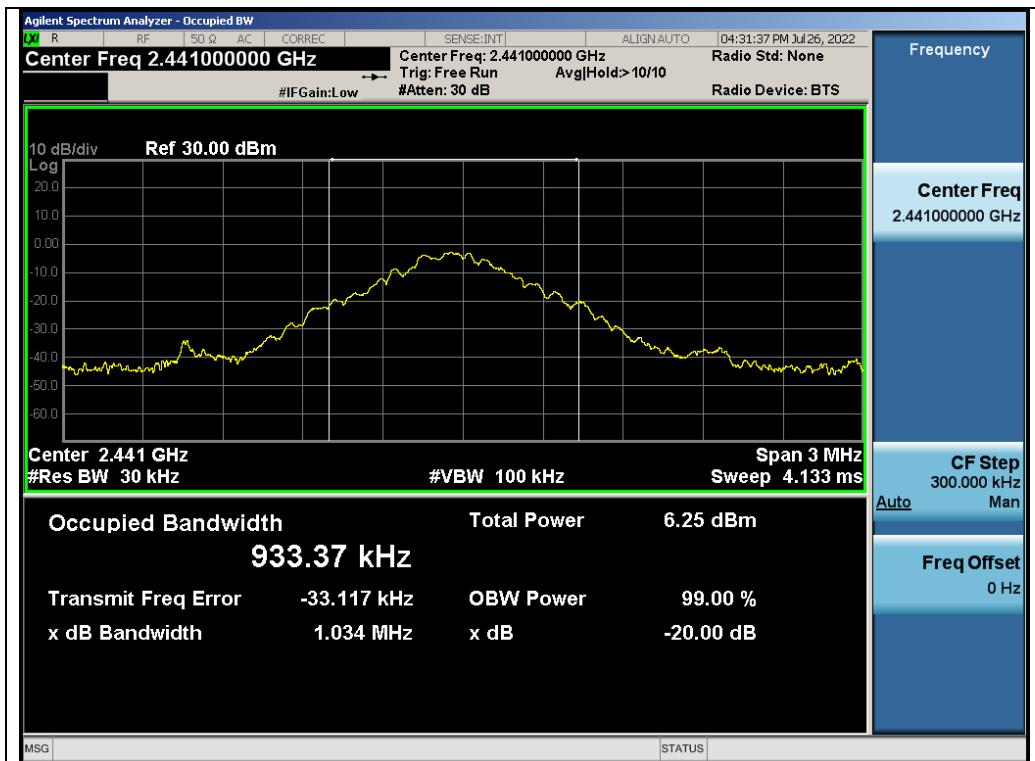

Test\_Graph\_BR\_ANT1\_2441\_1Mbps\_OBW

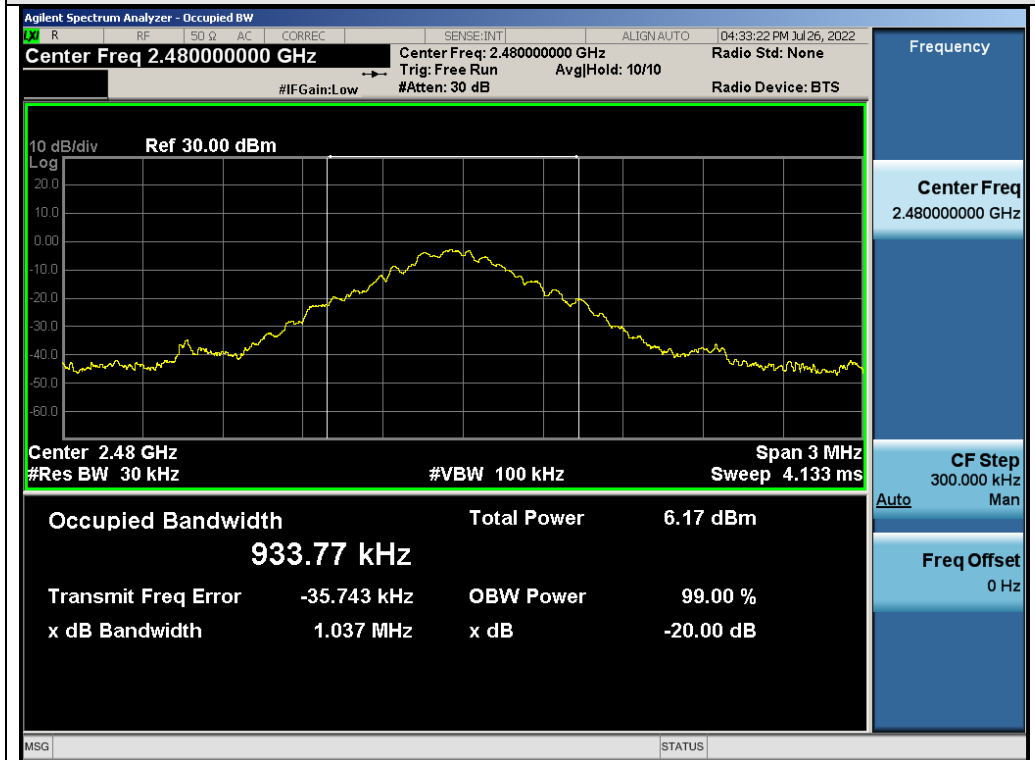

Test\_Graph\_BR\_ANT1\_2480\_1Mbps\_OBW

Any report having not been signed by authorized approver, or having been altered without authorization, or having not been stamped by the "Dedicated Testing/Inspection Stamp" is deemed to be invalid. Copying or excerpting portion of, or altering the content of the report is not permitted without the written authorization of AGC. The test results presented in the report apply only to the tested sample. Any objections to report issued by AGC should be submitted to AGC within 15days after the issuance of the test report. Further enquiry of validity or verification of the test report should be addressed to AGC by agc01@agccert.com.

## 9. CONDUCTED SPURIOUS EMISSION

### 9.1. MEASUREMENT PROCEDURE

1. Connect EUT RF output port to the Spectrum Analyzer through an RF attenuator
2. Set the EUT Work on the top, the Middle and the bottom operation frequency individually.
3. Set the Span = wide enough to capture the peak level of the in-band emission and all spurious emissions from the lowest frequency generated in the EUT up through the 10th harmonic.  
RBW = 100 kHz; VBW= 300 kHz; Sweep = auto; Detector function = peak.
4. Set SPA Trace 1 Max hold, then View.

### 9.2. TEST SET-UP (BLOCK DIAGRAM OF CONFIGURATION)

The same as described in section 8.2

### 9.3. MEASUREMENT EQUIPMENT USED

The same as described in section 6

### 9.4. LIMITS AND MEASUREMENT RESULT

LIMITS AND MEASUREMENT RESULT		
Applicable Limits	Measurement Result	
	Test Data	Criteria
In any 100 kHz Bandwidth Outside the frequency band in which the spread spectrum intentional radiator is operating, the radio frequency power that is produce by the intentional radiator shall be at least 20 dB below that in 100KHz bandwidth within the band that contains the highest level of the desired power. In addition, radiation emissions which fall in the restricted bands, as defined in §15.205(a), must also comply with the radiated emission limits specified in§15.209(a)	At least -20dBc than the limit Specified on the BOTTOM Channel	PASS
	At least -20dBc than the limit Specified on the TOP Channel	PASS

Any report having not been signed by authorized approver, or having been altered without authorization, or having not been stamped by the "Dedicated Testing/Inspection Stamp" is deemed to be invalid. Copying or excerpting portion of, or altering the content of the report is not permitted without the written authorization of AGC. The test results presented in the report apply only to the tested sample. Any objections to report issued by AGC should be submitted to AGC within 15days after the issuance of the test report. Further enquiry of validity or verification of the test report should be addressed to AGC by agc01@agccert.com.

### Test Graphs of Spurious Emissions in Non-Restricted Frequency Bands

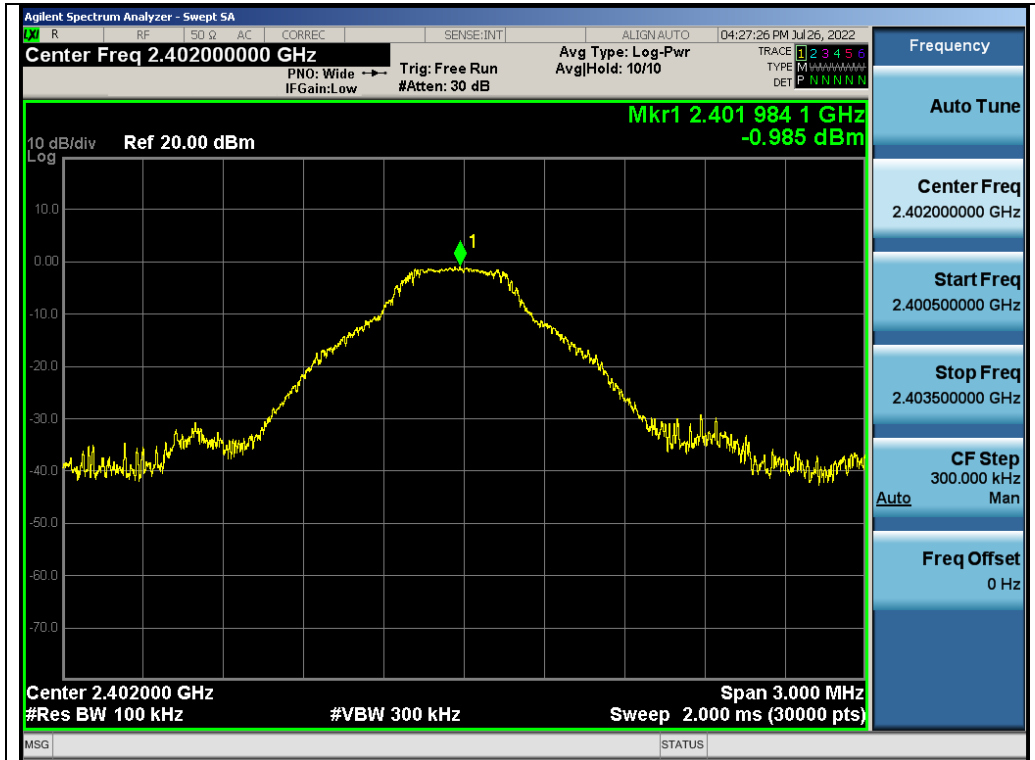

Test\_Graph\_BR\_ANT1\_2402\_1Mbps\_Reference Level

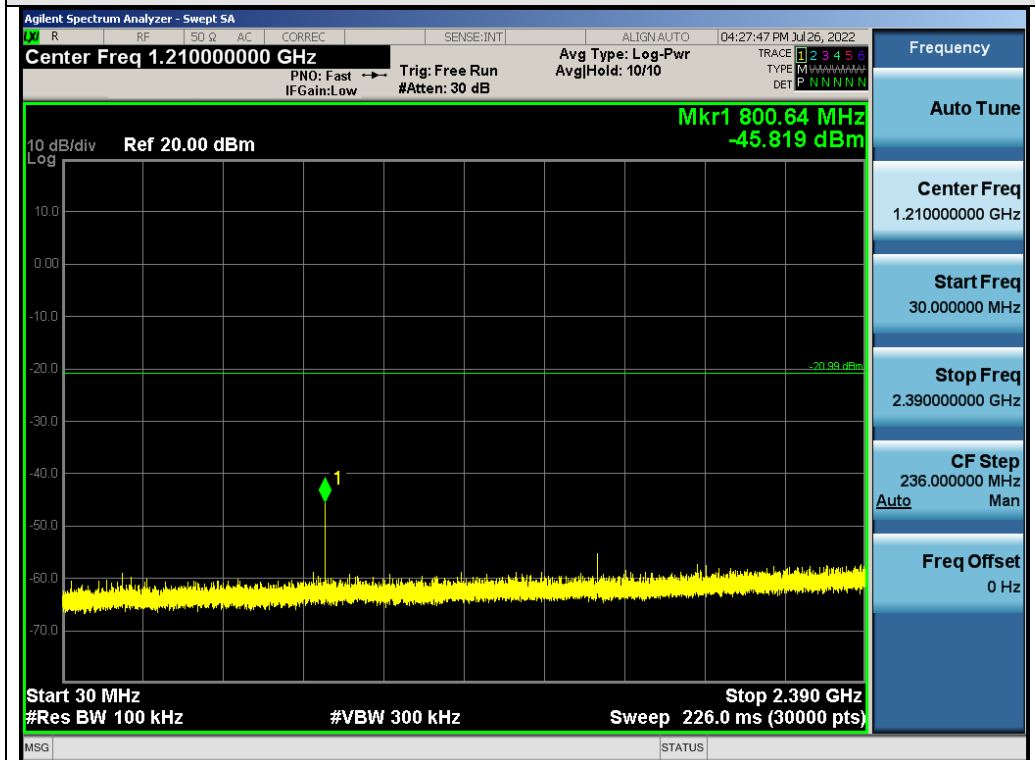

Test\_Graph\_BR\_ANT1\_2402\_1Mbps\_Lower Band Emissions

Any report having not been signed by authorized approver, or having been altered without authorization, or having not been stamped by the "Dedicated Testing/Inspection Stamp" is deemed to be invalid. Copying or excerpting portion of, or altering the content of the report is not permitted without the written authorization of AGC. The test results presented in the report apply only to the tested sample. Any objections to report issued by AGC should be submitted to AGC within 15days after the issuance of the test report. Further enquiry of validity or verification of the test report should be addressed to AGC by agc01@agccert.com.

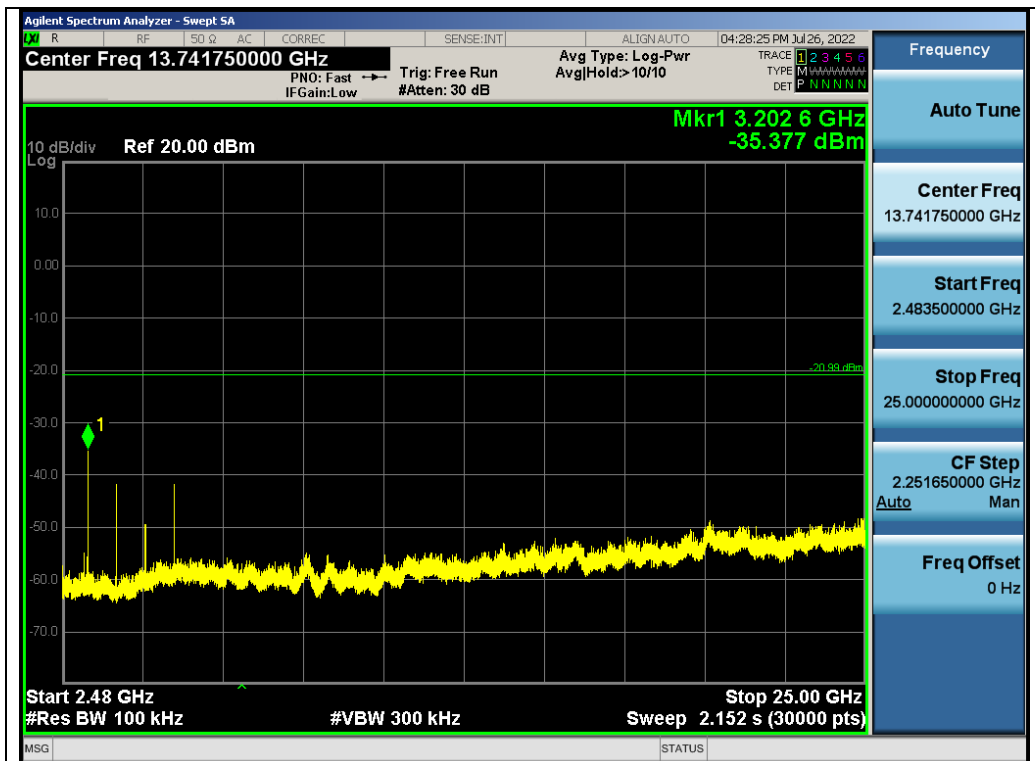

Test\_Graph\_BR\_ANT1\_2402\_1Mbps\_Higher Band Emissions

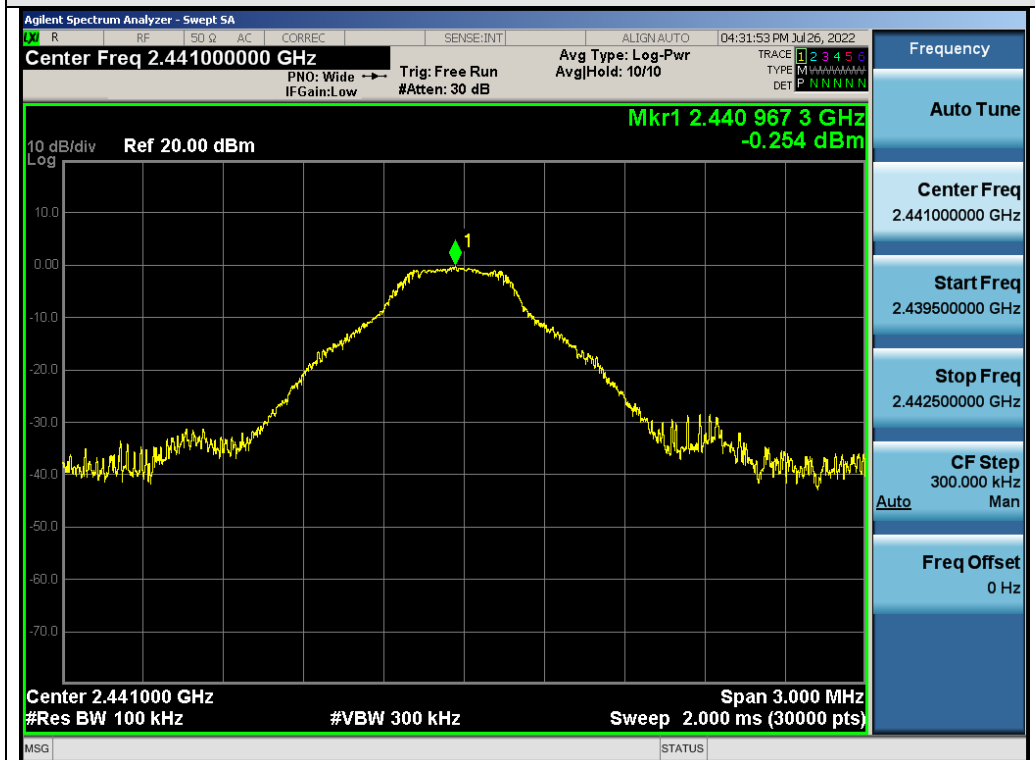

Test\_Graph\_BR\_ANT1\_2441\_1Mbps\_Reference Level

Any report having not been signed by authorized approver, or having been altered without authorization, or having not been stamped by the "Dedicated Testing/Inspection Stamp" is deemed to be invalid. Copying or excerpting portion of, or altering the content of the report is not permitted without the written authorization of AGC. The test results presented in the report apply only to the tested sample. Any objections to report issued by AGC should be submitted to AGC within 15days after the issuance of the test report. Further enquiry of validity or verification of the test report should be addressed to AGC by agc01@agccert.com.

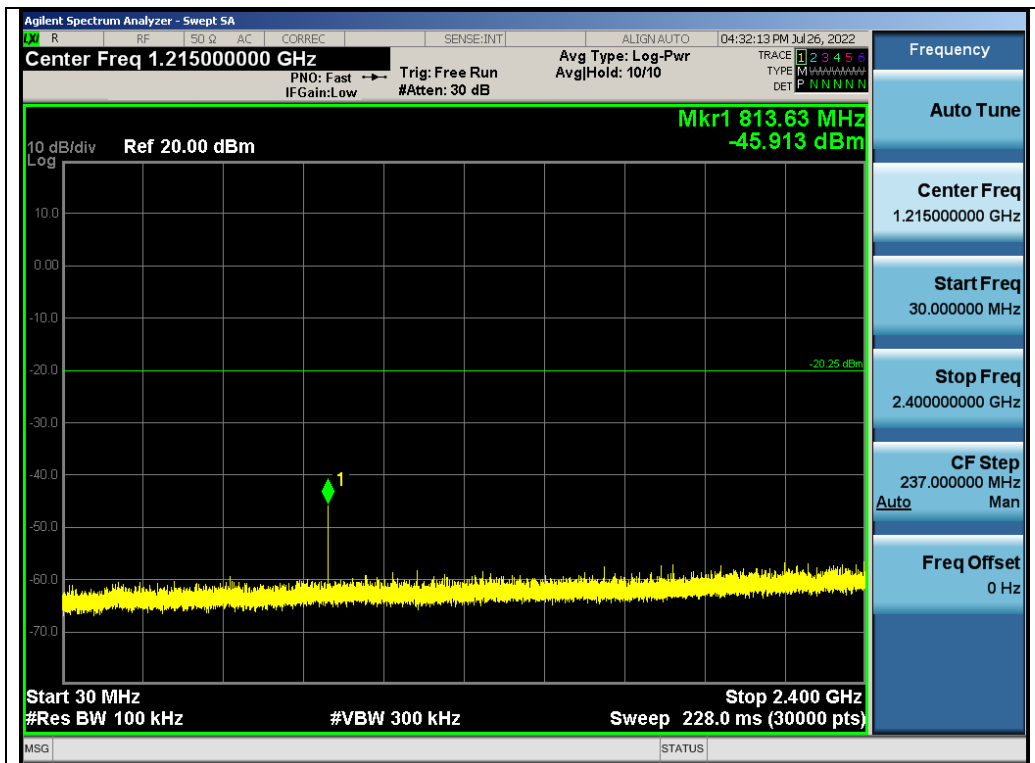

Test\_Graph\_BR\_ANT1\_2441\_1Mbps\_Lower Band Emissions

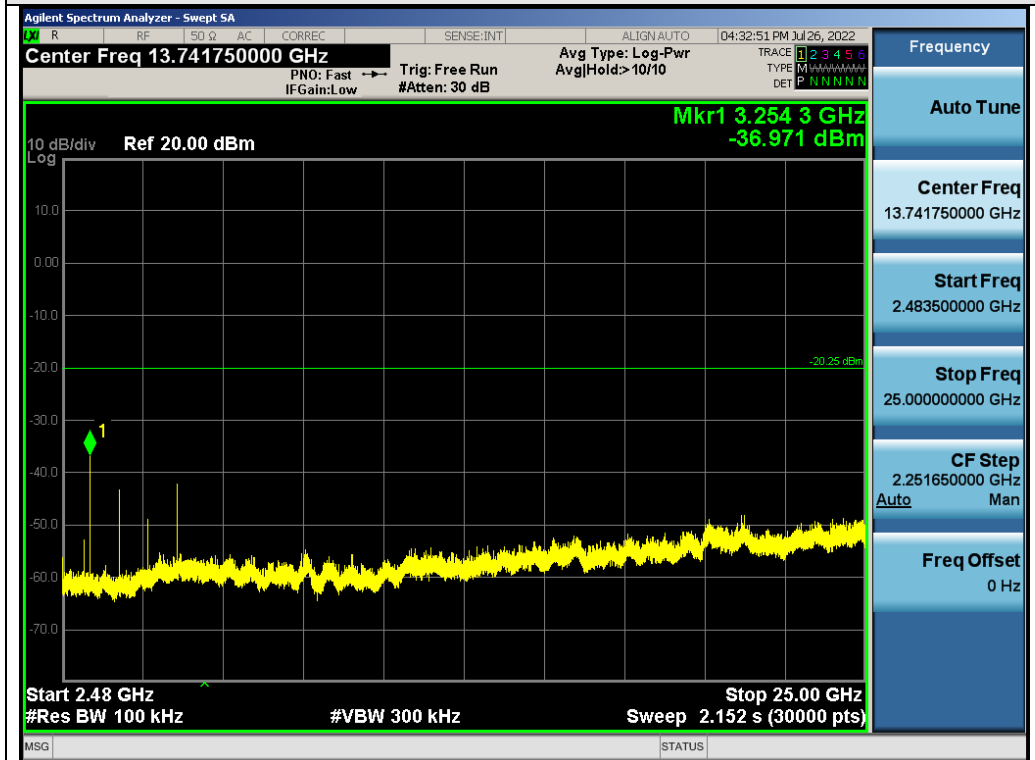

Test\_Graph\_BR\_ANT1\_2441\_1Mbps\_Higher Band Emissions

Any report having not been signed by authorized approver, or having been altered without authorization, or having not been stamped by the "Dedicated Testing/Inspection Stamp" is deemed to be invalid. Copying or excerpting portion of, or altering the content of the report is not permitted without the written authorization of AGC. The test results presented in the report apply only to the tested sample. Any objections to report issued by AGC should be submitted to AGC within 15days after the issuance of the test report. Further enquiry of validity or verification of the test report should be addressed to AGC by agc01@agccert.com.



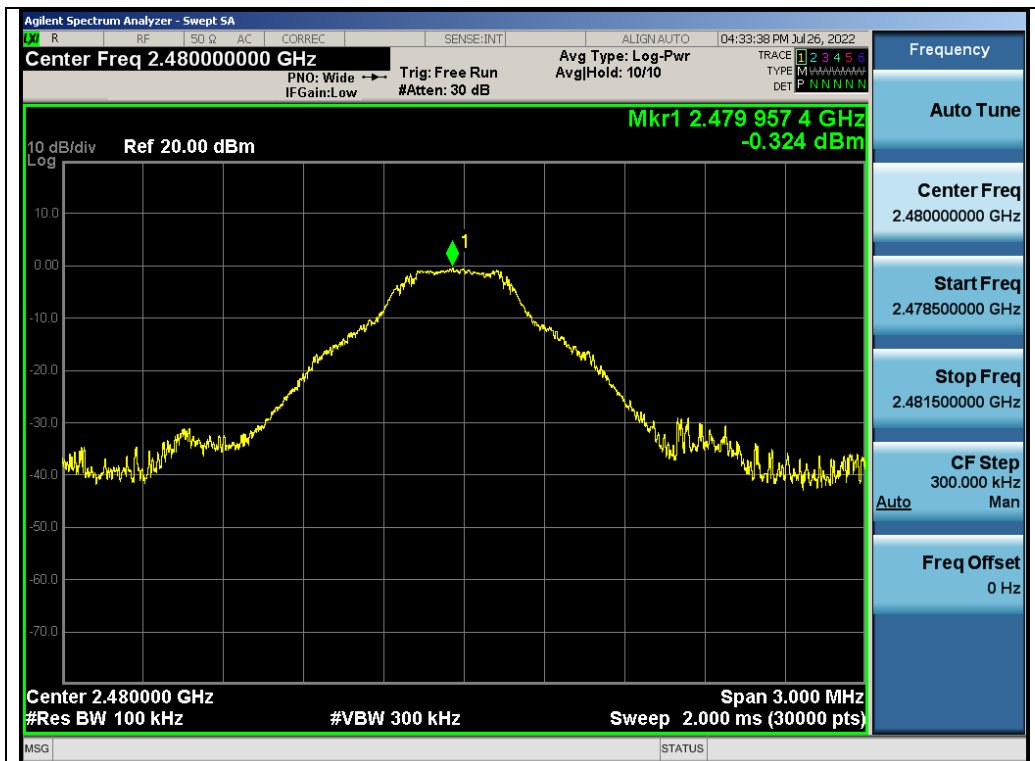

Test\_Graph\_BR\_ANT1\_2480\_1Mbps\_Reference Level

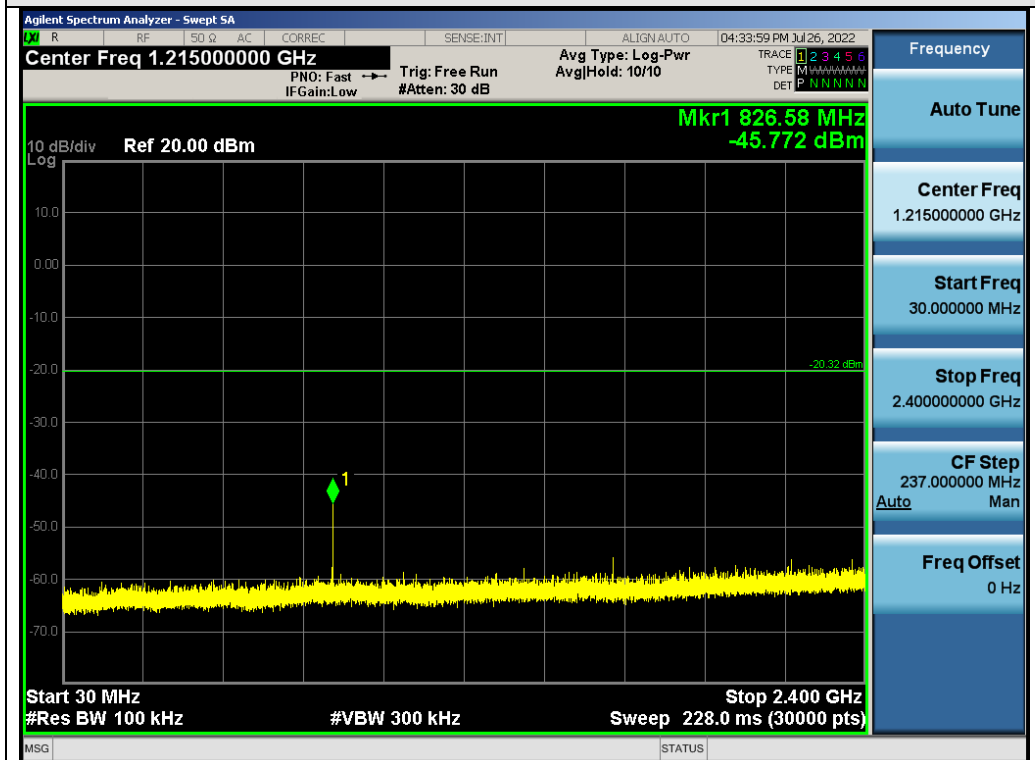

Test\_Graph\_BR\_ANT1\_2480\_1Mbps\_Lower Band Emissions

Any report having not been signed by authorized approver, or having been altered without authorization, or having not been stamped by the "Dedicated Testing/Inspection Stamp" is deemed to be invalid. Copying or excerpting portion of, or altering the content of the report is not permitted without the written authorization of AGC. The test results presented in the report apply only to the tested sample. Any objections to report issued by AGC should be submitted to AGC within 15days after the issuance of the test report. Further enquiry of validity or verification of the test report should be addressed to AGC by agc01@agccert.com.

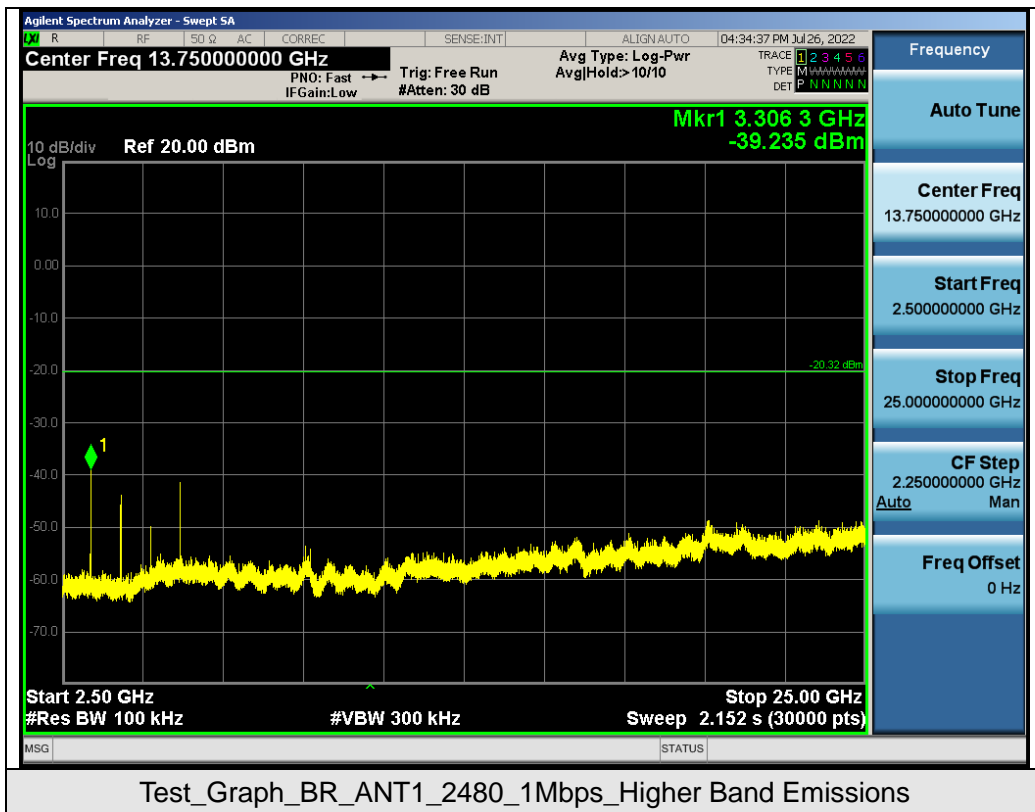

Any report having not been signed by authorized approver, or having been altered without authorization, or having not been stamped by the "Dedicated Testing/Inspection Stamp" is deemed to be invalid. Copying or excerpting portion of, or altering the content of the report is not permitted without the written authorization of AGC. The test results presented in the report apply only to the tested sample. Any objections to report issued by AGC should be submitted to AGC within 15days after the issuance of the test report. Further enquiry of validity or verification of the test report should be addressed to AGC by agc01@agccert.com.

### Test Graphs of Band Edge Emissions in Non-Restricted Frequency Bands

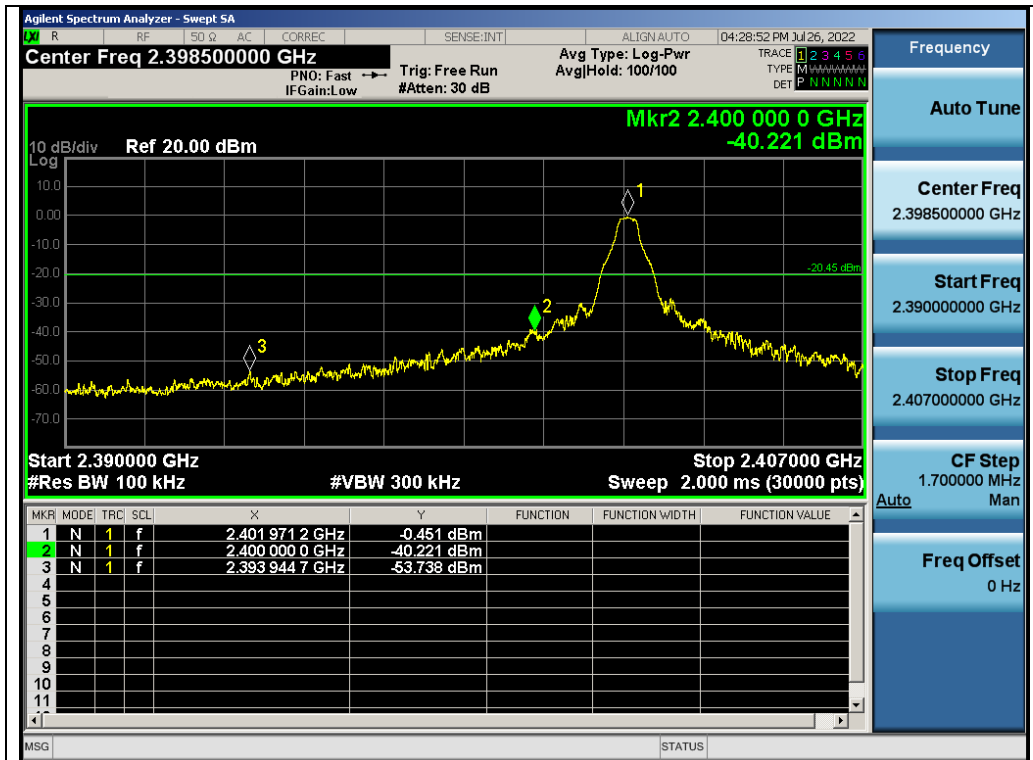

Test\_Graph\_BR\_ANT1\_2402\_1Mbps\_Lower Band Edge Emissions

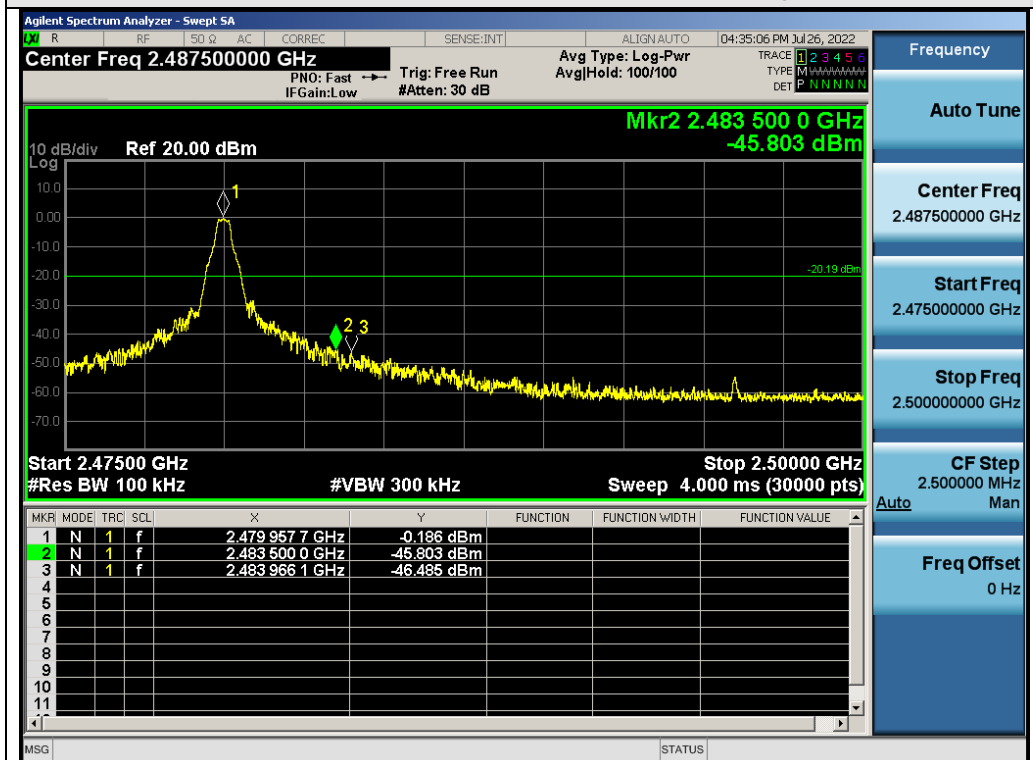

Test\_Graph\_BR\_ANT1\_2480\_1Mbps\_Higher Band Edge Emissions

Any report having not been signed by authorized approver, or having been altered without authorization, or having not been stamped by the "Dedicated Testing/Inspection Stamp" is deemed to be invalid. Copying or excerpting portion of, or altering the content of the report is not permitted without the written authorization of AGC. The test results presented in the report apply only to the tested sample. Any objections to report issued by AGC should be submitted to AGC within 15days after the issuance of the test report. Further enquiry of validity or verification of the test report should be addressed to AGC by agc01@agccert.com.

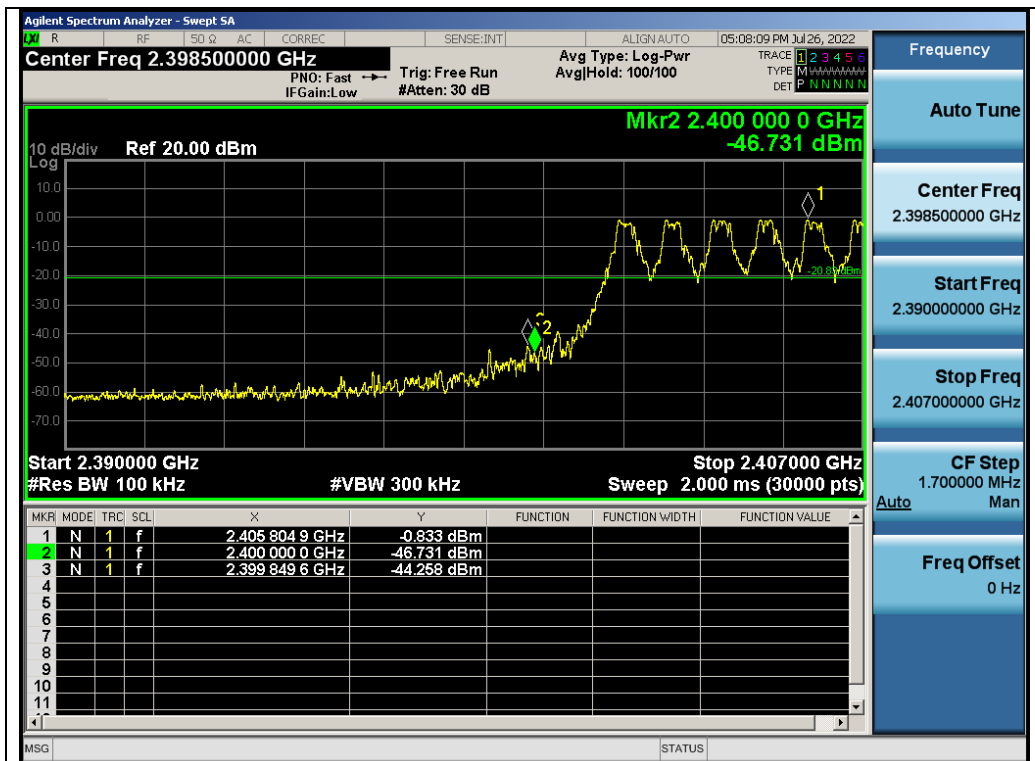

Test\_Graph\_BR\_HOP\_ANT1\_NA\_1Mbps\_Lower Band Edge Emissions

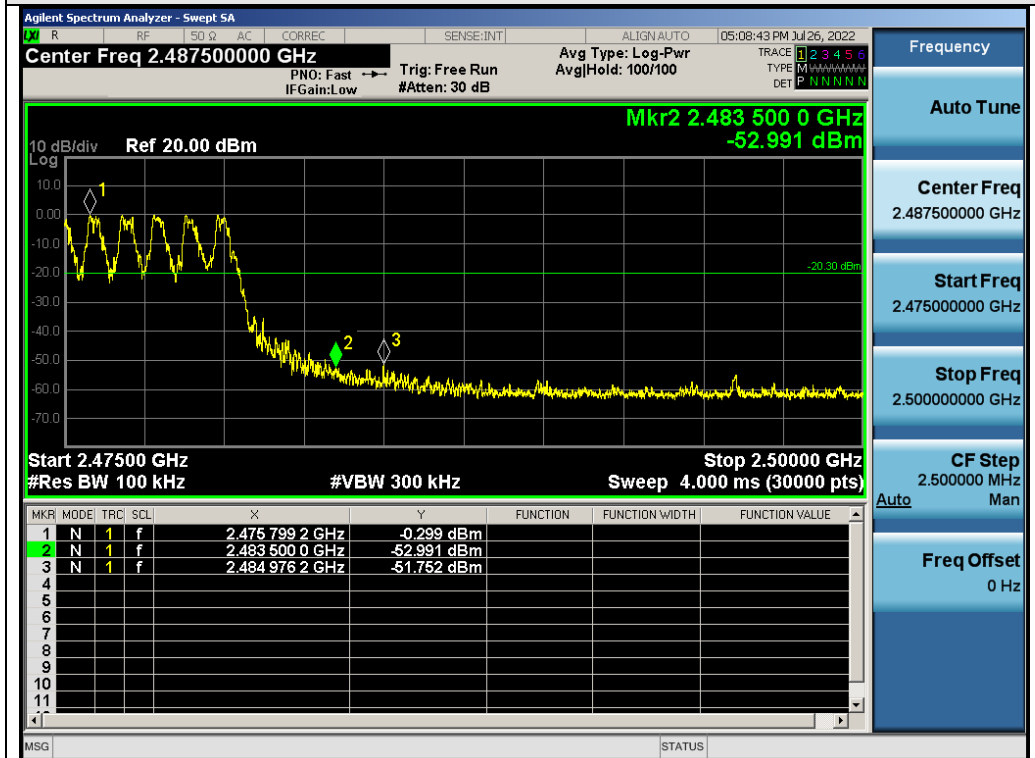

Test\_Graph\_BR\_HOP\_ANT1\_NA\_1Mbps\_Higher Band Edge Emissions

Any report having not been signed by authorized approver, or having been altered without authorization, or having not been stamped by the "Dedicated Testing/Inspection Stamp" is deemed to be invalid. Copying or excerpting portion of, or altering the content of the report is not permitted without the written authorization of AGC. The test results presented in the report apply only to the tested sample. Any objections to report issued by AGC should be submitted to AGC within 15days after the issuance of the test report. Further enquiry of validity or verification of the test report should be addressed to AGC by agc01@agccert.com.

## 10. RADIATED EMISSION

### 10.1. MEASUREMENT PROCEDURE

1. The EUT was placed on the top of the turntable 0.8 or 1.5 meter above ground. The phase center of the receiving antenna mounted on the top of a height-variable antenna tower was placed 3 meters far away from the turntable.
2. Power on the EUT and all the supporting units. The turntable was rotated by 360 degrees to determine the position of the highest radiation.
3. The height of the broadband receiving antenna was varied between one meter and four meters above ground to find the maximum emissions field strength of both horizontal and vertical polarization.
4. For each suspected emission, the antenna tower was scan (from 1 M to 4 M) and then the turntable was rotated (from 0 degree to 360 degrees) to find the maximum reading.
5. Set the test-receiver system to Peak or CISPR quasi-peak Detect Function with specified bandwidth under Maximum Hold Mode.
6. For emissions above 1GHz, use 1MHz RBW and 3MHz VBW for peak reading. Place the measurement antenna away from each area of the EUT determined to be a source of emissions at the specified measurement distance, while keeping the measurement antenna aimed at the source of emissions at each frequency of significant emissions, with polarization oriented for maximum response. The measurement antenna may have to be higher or lower than the EUT, depending on the radiation pattern of the emission and staying aimed at the emission source for receiving the maximum signal. The final measurement antenna elevation shall be that which maximizes the emissions. The measurement antenna elevation for maximum emissions shall be restricted to a range of heights of from 1 m to 4 m above the ground or reference ground plane.
7. When the radiated emissions limits are expressed in terms of the average value of the emissions, and pulsed operation is employed, the measurement field strength shall be determined by averaging over one complete pulse train, including blanking intervals, as long as the pulse train does not exceed 0.1 seconds. As an alternative (provided the transmitter operates for longer than 0.1 seconds) or in cases where the pulse train exceeds 0.1 seconds, the measured field strength shall be determined from the average absolute voltage during a 0.1 second interval during which the field strength is at its maximum values.
8. If the emissions level of the EUT in peak mode was 3 dB lower than the average limit specified, then testing will be stopped and peak values of EUT will be reported, otherwise, the emissions which do not have 3 dB margin will be repeated one by one using the quasi-peak method for below 1GHz.
9. For testing above 1GHz, the emissions level of the EUT in peak mode was lower than average limit (that means the emissions level in peak mode also complies with the limit in average mode), then testing will be stopped and peak values of EUT will be reported, otherwise, the emissions will be measured in average mode again and reported.
10. In case the emission is lower than 30MHz, loop antenna has to be used for measurement and the recorded data should be QP measured by receiver. High - Low scan is not required in this case.

The following table is the setting of spectrum analyzer and receiver.

Spectrum Parameter	Setting
Start ~Stop Frequency	9KHz~150KHz/RB 200Hz for QP
Start ~Stop Frequency	150KHz~30MHz/RB 9KHz for QP
Start ~Stop Frequency	30MHz~1000MHz/RB 120KHz for QP
Start ~Stop Frequency	1GHz~26.5GHz 1MHz/3MHz for Peak, 1MHz/3MHz for Average

Receiver Parameter	Setting
Start ~Stop Frequency	9KHz~150KHz/RB 200Hz for QP
Start ~Stop Frequency	150KHz~30MHz/RB 9KHz for QP
Start ~Stop Frequency	30MHz~1000MHz/RB 120KHz for QP

Any report having not been signed by authorized approver, or having been altered without authorization, or having not been stamped by the "Dedicated Testing/Inspection Stamp" is deemed to be invalid. Copying or excerpting portion of, or altering the content of the report is not permitted without the written authorization of AGC. The test results presented in the report apply only to the tested sample. Any objections to report issued by AGC should be submitted to AGC within 15days after the issuance of the test report. Further enquiry of validity or verification of the test report should be addressed to AGC by agc01@agccert.com.

### 10.2. TEST SETUP

Radiated Emission Test-Setup Frequency Below 30MHz

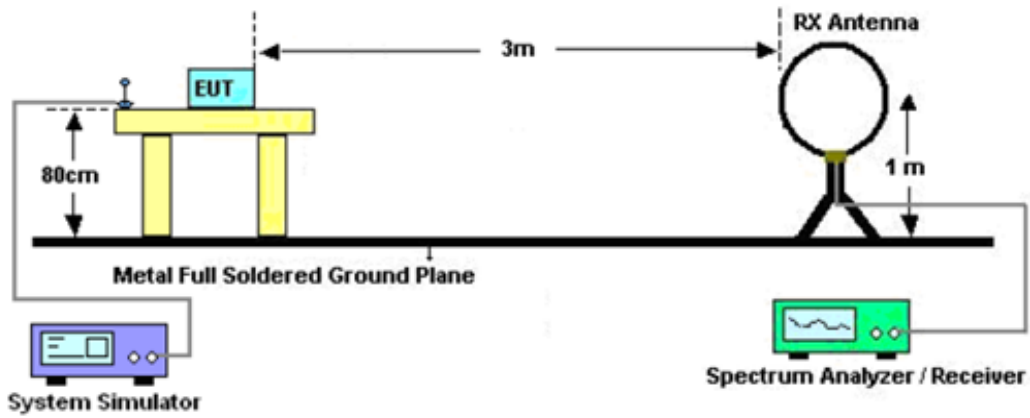

RADIATED EMISSION TEST SETUP 30MHz-1000MHz

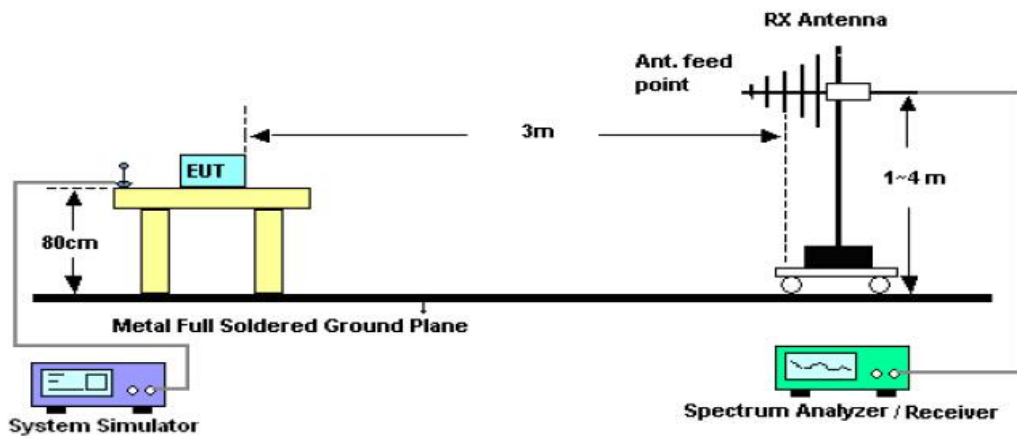

RADIATED EMISSION TEST SETUP ABOVE 1000MHz

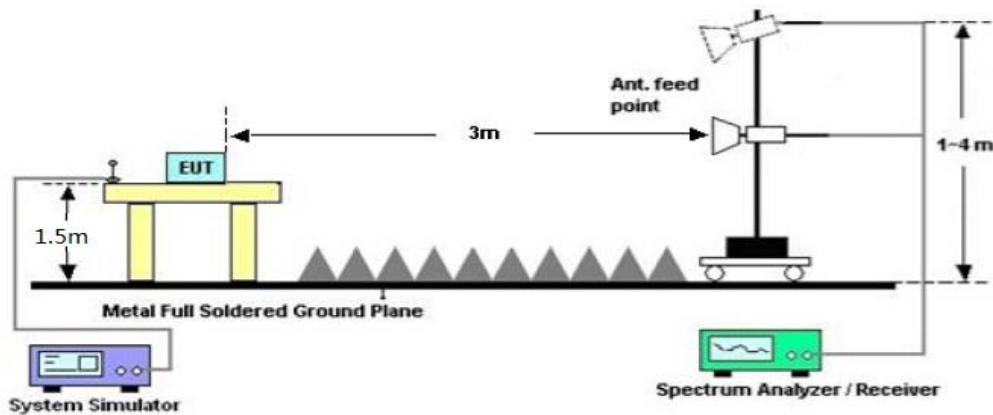

Any report having not been signed by authorized approver, or having been altered without authorization, or having not been stamped by the “Dedicated Testing/Inspection Stamp” is deemed to be invalid. Copying or excerpting portion of, or altering the content of the report is not permitted without the written authorization of AGC. The test results presented in the report apply only to the tested sample. Any objections to report issued by AGC should be submitted to AGC within 15 days after the issuance of the test report. Further enquiry of validity or verification of the test report should be addressed to AGC by [agc01@agccert.com](mailto:agc01@agccert.com).



### 10.3. LIMITS AND MEASUREMENT RESULT

15.209 Limit in the below table has to be followed

Frequencies (MHz)	Field Strength (microvolts/meter)	Measurement Distance (meters)
0.009~0.490	2400/F(kHz)	300
0.490~1.705	24000/F(kHz)	30
1.705~30.0	30	30
30~88	100	3
88~216	150	3
216~960	200	3
Above 960	500	3

Note: All modes were tested for restricted band radiated emission, the test records reported below are the worst result compared to other modes.

### 10.4. TEST RESULT

#### Radiated emission below 30MHz

The amplitude of spurious emissions from 9kHz to 30MHz which are attenuated more than 20 dB below the permissible value need not be reported.

Any report having not been signed by authorized approver, or having been altered without authorization, or having not been stamped by the "Dedicated Testing/Inspection Stamp" is deemed to be invalid. Copying or excerpting portion of, or altering the content of the report is not permitted without the written authorization of AGC. The test results presented in the report apply only to the tested sample. Any objections to report issued by AGC should be submitted to AGC within 15days after the issuance of the test report. Further enquiry of validity or verification of the test report should be addressed to AGC by agc01@agccert.com.

**Radiated emission from 30MHz to 1000MHz**

<b>EUT</b>	Label Printer	<b>Model Name</b>	NIIMBOT B1
<b>Temperature</b>	22°C	<b>Relative Humidity</b>	53%
<b>Pressure</b>	985hPa	<b>Test Voltage</b>	Normal Voltage
<b>Test Mode</b>	Mode 2	<b>Antenna</b>	Horizontal

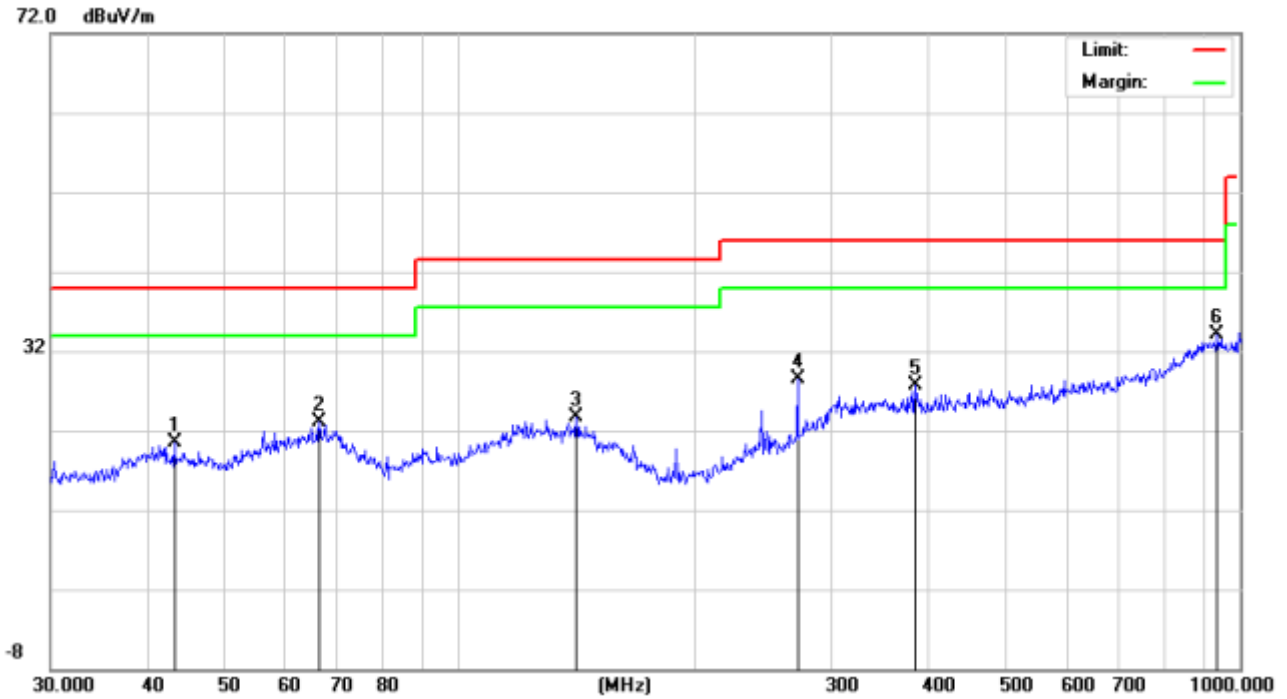

No.	Mk.	Freq. MHz	Reading Level dBuV	Correct Factor dB	Measure- ment dBuV/m	Limit dBuV/m	Over dB	Detector
1		43.2017	5.84	14.65	20.49	40.00	-19.51	peak
2		66.2662	6.30	16.87	23.17	40.00	-16.83	peak
3		141.3298	6.25	17.54	23.79	43.50	-19.71	peak
4		271.3246	10.74	17.80	28.54	46.00	-17.46	peak
5		383.9318	7.00	20.64	27.64	46.00	-18.36	peak
6	*	935.5463	6.27	27.90	34.17	46.00	-11.83	peak

**RESULT: PASS**

Any report having not been signed by authorized approver, or having been altered without authorization, or having not been stamped by the "Dedicated Testing/Inspection Stamp" is deemed to be invalid. Copying or excerpting portion of, or altering the content of the report is not permitted without the written authorization of AGC. The test results presented in the report apply only to the tested sample. Any objections to report issued by AGC should be submitted to AGC within 15days after the issuance of the test report. Further enquiry of validity or verification of the test report should be addressed to AGC by agc01@agccert.com.

EUT	Label Printer	Model Name	NIIMBOT B1
Temperature	22°C	Relative Humidity	53%
Pressure	985hPa	Test Voltage	Normal Voltage
Test Mode	Mode 2	Antenna	Vertical

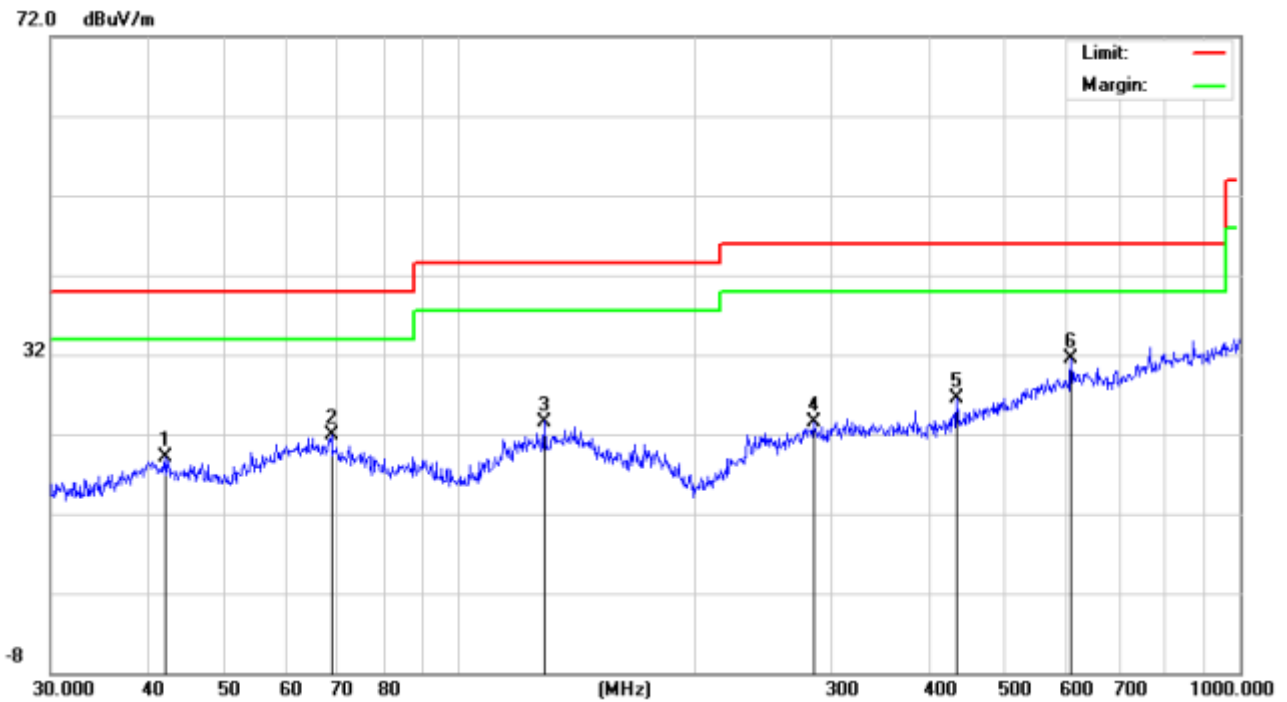

No.	Mk.	Freq. MHz	Reading Level dBuV	Correct Factor dB	Measure- ment dBuV/m	Limit dBuV/m	Over dB	Detector
1		42.1542	4.43	14.72	19.15	40.00	-20.85	peak
2		68.6310	4.90	17.08	21.98	40.00	-18.02	peak
3		128.5629	5.52	18.08	23.60	43.50	-19.90	peak
4		284.9766	3.59	19.82	23.41	46.00	-22.59	peak
5		434.0650	6.54	20.01	26.55	46.00	-19.45	peak
6	*	607.7866	6.55	24.97	31.52	46.00	-14.48	peak

**RESULT: PASS**

**Note:** 1. Factor=Antenna Factor + Cable loss, Over=Measurement-Limit.

2. All test modes had been pre-tested. The mode 2 is the worst case and recorded in the report.

Any report having not been signed by authorized approver, or having been altered without authorization, or having not been stamped by the "Dedicated Testing/Inspection Stamp" is deemed to be invalid. Copying or excerpting portion of, or altering the content of the report is not permitted without the written authorization of AGC. The test results presented in the report apply only to the tested sample. Any objections to report issued by AGC should be submitted to AGC within 15days after the issuance of the test report. Further enquiry of validity or verification of the test report should be addressed to AGC by agc01@agccert.com.

**Radiated emission above 1GHz**

<b>EUT</b>	Label Printer	<b>Model Name</b>	NIIMBOT B1
<b>Temperature</b>	22°C	<b>Relative Humidity</b>	53%
<b>Pressure</b>	985hPa	<b>Test Voltage</b>	Normal Voltage
<b>Test Mode</b>	Mode 1	<b>Antenna</b>	Horizontal

Frequency (MHz)	Meter Reading (dBµV)	Factor (dB)	Emission Level (dBµV/m)	Limits (dBµV/m)	Margin (dB)	Value Type
4804.000	50.61	0.08	50.69	74	-23.31	peak
4804.000	38.45	0.08	38.53	54	-15.47	AVG
7206.000	45.91	2.21	48.12	74	-25.88	peak
7206.000	34.33	2.21	36.54	54	-17.46	AVG

Remark:  
Factor = Antenna Factor + Cable Loss – Pre-amplifier.

<b>EUT</b>	Label Printer	<b>Model Name</b>	NIIMBOT B1
<b>Temperature</b>	22°C	<b>Relative Humidity</b>	53%
<b>Pressure</b>	985hPa	<b>Test Voltage</b>	Normal Voltage
<b>Test Mode</b>	Mode 1	<b>Antenna</b>	Vertical

Frequency (MHz)	Meter Reading (dBµV)	Factor (dB)	Emission Level (dBµV/m)	Limits (dBµV/m)	Margin (dB)	Value Type
4804.000	48.25	0.08	48.33	74	-25.67	peak
4804.000	37.95	0.08	38.03	54	-15.97	AVG
7206.000	44.18	2.21	46.39	74	-27.61	peak
7206.000	33.26	2.21	35.47	54	-18.53	AVG

Remark:  
Factor = Antenna Factor + Cable Loss – Pre-amplifier.

Any report having not been signed by authorized approver, or having been altered without authorization, or having not been stamped by the “Dedicated Testing/Inspection Stamp” is deemed to be invalid. Copying or excerpting portion of, or altering the content of the report is not permitted without the written authorization of AGC. The test results presented in the report apply only to the tested sample. Any objections to report issued by AGC should be submitted to AGC within 15days after the issuance of the test report. Further enquiry of validity or verification of the test report should be addressed to AGC by agc01@agccert.com.

<b>EUT</b>	Label Printer	<b>Model Name</b>	NIIMBOT B1
<b>Temperature</b>	22°C	<b>Relative Humidity</b>	53%
<b>Pressure</b>	985hPa	<b>Test Voltage</b>	Normal Voltage
<b>Test Mode</b>	Mode 2	<b>Antenna</b>	Horizontal

Frequency (MHz)	Meter Reading (dBμV)	Factor (dB)	Emission Level (dBμV/m)	Limits (dBμV/m)	Margin (dB)	Value Type
4882.000	51.25	0.14	51.39	74	-22.61	peak
4882.000	39.57	0.14	39.71	54	-14.29	AVG
7323.000	46.32	2.36	48.68	74	-25.32	peak
7323.000	35.36	2.36	37.72	54	-16.28	AVG

Remark:  
Factor = Antenna Factor + Cable Loss – Pre-amplifier.

<b>EUT</b>	Label Printer	<b>Model Name</b>	NIIMBOT B1
<b>Temperature</b>	22°C	<b>Relative Humidity</b>	53%
<b>Pressure</b>	985hPa	<b>Test Voltage</b>	Normal Voltage
<b>Test Mode</b>	Mode 2	<b>Antenna</b>	Vertical

Frequency (MHz)	Meter Reading (dBμV)	Factor (dB)	Emission Level (dBμV/m)	Limits (dBμV/m)	Margin (dB)	Value Type
4882.000	49.31	0.14	49.45	74	-24.55	peak
4882.000	38.75	0.14	38.89	54	-15.11	AVG
7323.000	45.07	2.36	47.43	74	-26.57	peak
7323.000	34.18	2.36	36.54	54	-17.46	AVG

Remark:  
Factor = Antenna Factor + Cable Loss – Pre-amplifier.

Any report having not been signed by authorized approver, or having been altered without authorization, or having not been stamped by the “Dedicated Testing/Inspection Stamp” is deemed to be invalid. Copying or excerpting portion of, or altering the content of the report is not permitted without the written authorization of AGC. The test results presented in the report apply only to the tested sample. Any objections to report issued by AGC should be submitted to AGC within 15days after the issuance of the test report. Further enquiry of validity or verification of the test report should be addressed to AGC by agc01@agccert.com.

<b>EUT</b>	Label Printer	<b>Model Name</b>	NIIMBOT B1
<b>Temperature</b>	22°C	<b>Relative Humidity</b>	53%
<b>Pressure</b>	985hPa	<b>Test Voltage</b>	Normal Voltage
<b>Test Mode</b>	Mode 3	<b>Antenna</b>	Horizontal

Frequency (MHz)	Meter Reading (dBμV)	Factor (dB)	Emission Level (dBμV/m)	Limits (dBμV/m)	Margin (dB)	Value Type
4960.000	50.46	0.22	50.68	74	-23.32	peak
4960.000	39.44	0.22	39.66	54	-14.34	AVG
7440.000	46.21	2.64	48.85	74	-25.15	peak
7440.000	35.82	2.64	38.46	54	-15.54	AVG

Remark:

Factor = Antenna Factor + Cable Loss – Pre-amplifier.

<b>EUT</b>	Label Printer	<b>Model Name</b>	NIIMBOT B1
<b>Temperature</b>	22°C	<b>Relative Humidity</b>	53%
<b>Pressure</b>	985hPa	<b>Test Voltage</b>	Normal Voltage
<b>Test Mode</b>	Mode 3	<b>Antenna</b>	Vertical

Frequency (MHz)	Meter Reading (dBμV)	Factor (dB)	Emission Level (dBμV/m)	Limits (dBμV/m)	Margin (dB)	Value Type
4960.000	48.76	0.22	48.98	74	-25.02	peak
4960.000	37.16	0.22	37.38	54	-16.62	AVG
7440.000	44.52	2.64	47.16	74	-26.84	peak
7440.000	33.93	2.64	36.57	54	-17.43	AVG

Remark:

Factor = Antenna Factor + Cable Loss – Pre-amplifier.

**RESULT: PASS**

**Note:**

The amplitude of other spurious emissions from 1G to 25 GHz which are attenuated more than 20 dB below the permissible value need not be reported.

Factor = Antenna Factor + Cable loss - Amplifier gain, Margin=Emission Level-Limit.

The “Factor” value can be calculated automatically by software of measurement system.

Any report having not been signed by authorized approver, or having been altered without authorization, or having not been stamped by the “Dedicated Testing/Inspection Stamp” is deemed to be invalid. Copying or excerpting portion of, or altering the content of the report is not permitted without the written authorization of AGC. The test results presented in the report apply only to the tested sample. Any objections to report issued by AGC should be submitted to AGC within 15days after the issuance of the test report. Further enquiry of validity or verification of the test report should be addressed to AGC by agc01@agccert.com.

**Test result for band edge emission at restricted bands**

<b>EUT</b>	Label Printer	<b>Model Name</b>	NIIMBOT B1
<b>Temperature</b>	25°C	<b>Relative Humidity</b>	55%
<b>Pressure</b>	985hPa	<b>Test Voltage</b>	Normal Voltage
<b>Test Mode</b>	Mode 1	<b>Antenna</b>	Horizontal

Test Graph for Peak Measurement

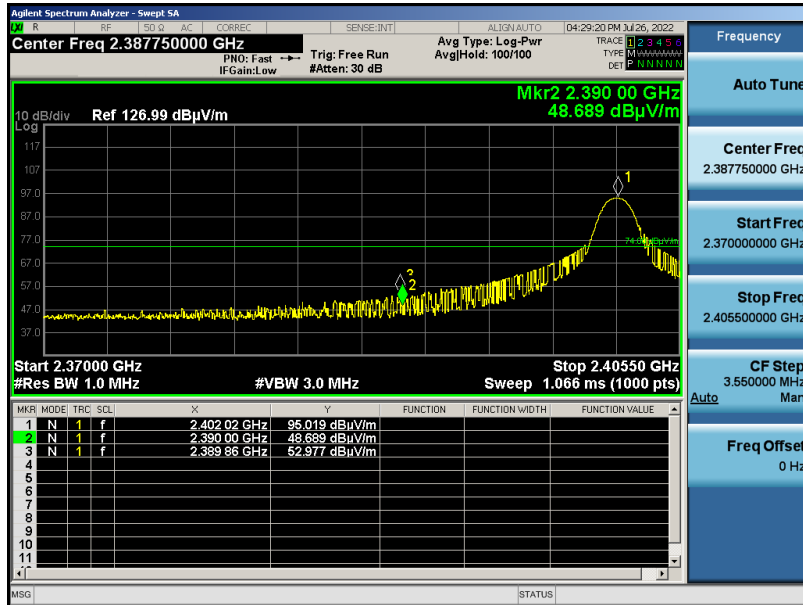

Test Graph for Average Measurement

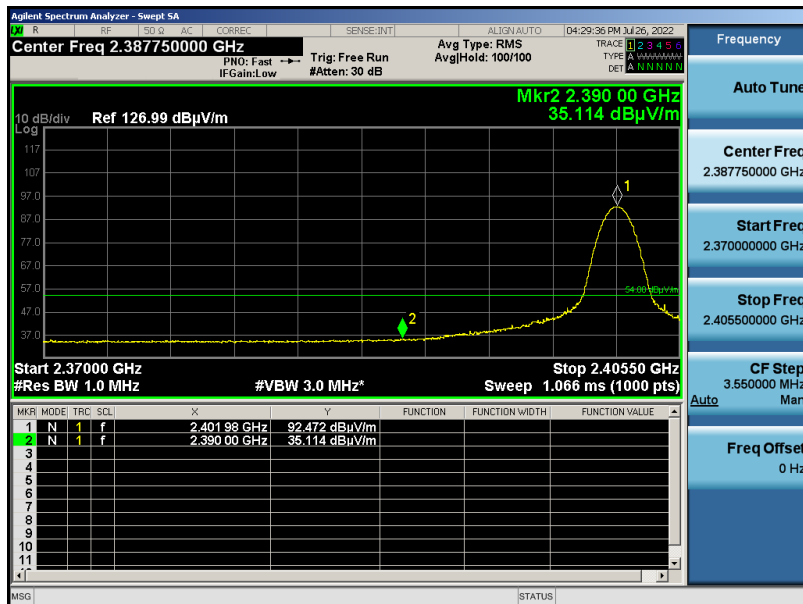

**RESULT: PASS**

Any report having not been signed by authorized approver, or having been altered without authorization, or having not been stamped by the "Dedicated Testing/Inspection Stamp" is deemed to be invalid. Copying or excerpting portion of, or altering the content of the report is not permitted without the written authorization of AGC. The test results presented in the report apply only to the tested sample. Any objections to report issued by AGC should be submitted to AGC within 15days after the issuance of the test report. Further enquiry of validity or verification of the test report should be addressed to AGC by agc01@agccert.com.



EUT	Label Printer	Model Name	NIIMBOT B1
Temperature	25°C	Relative Humidity	55%
Pressure	985hPa	Test Voltage	Normal Voltage
Test Mode	Mode 1	Antenna	Vertical

Test Graph for Peak Measurement

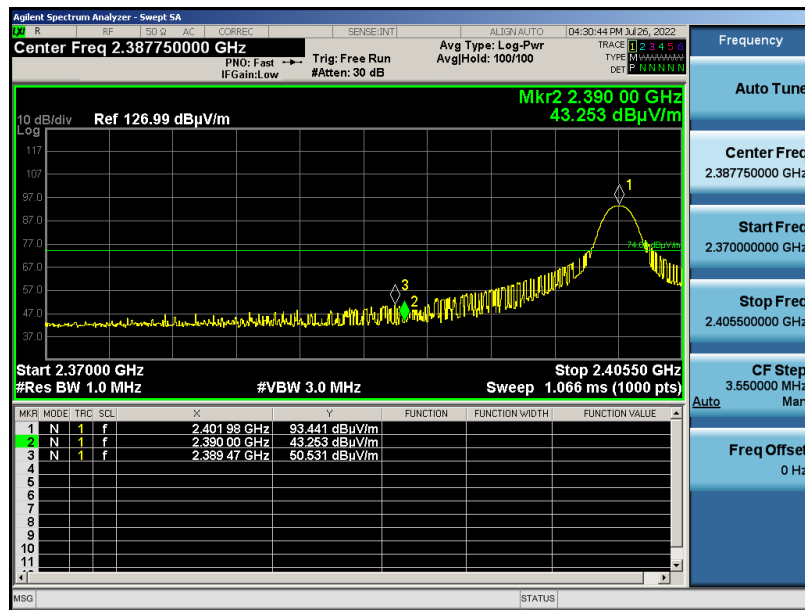

Test Graph for Average Measurement

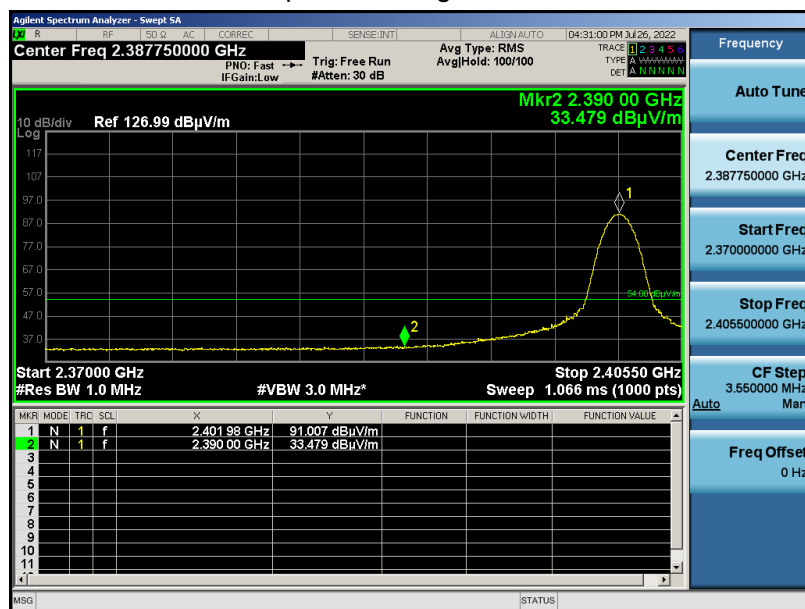

**RESULT: PASS**

Any report having not been signed by authorized approver, or having been altered without authorization, or having not been stamped by the "Dedicated Testing/Inspection Stamp" is deemed to be invalid. Copying or excerpting portion of, or altering the content of the report is not permitted without the written authorization of AGC. The test results presented in the report apply only to the tested sample. Any objections to report issued by AGC should be submitted to AGC within 15days after the issuance of the test report. Further enquiry of validity or verification of the test report should be addressed to AGC by agc01@agccert.com.

EUT	Label Printer	Model Name	NIIMBOT B1
Temperature	25°C	Relative Humidity	55%
Pressure	985hPa	Test Voltage	Normal Voltage
Test Mode	Mode 3	Antenna	Horizontal

Test Graph for Peak Measurement

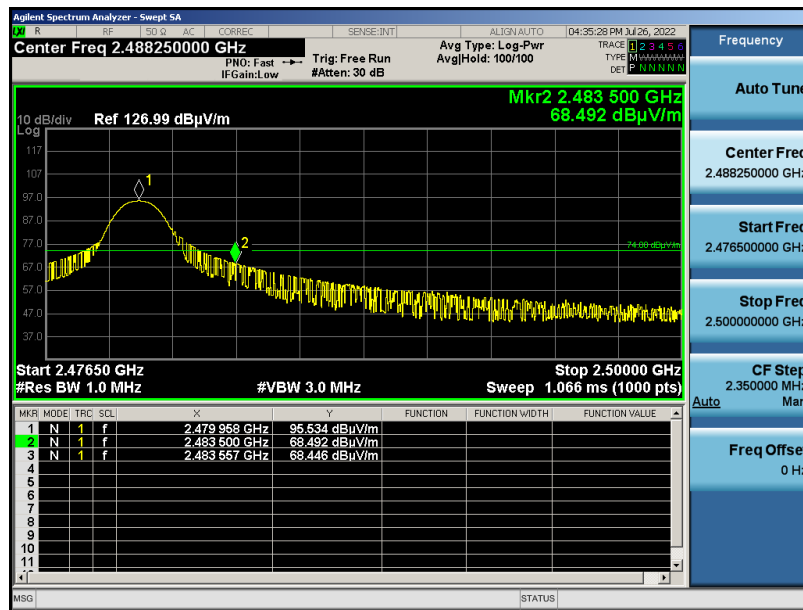

Test Graph for Average Measurement

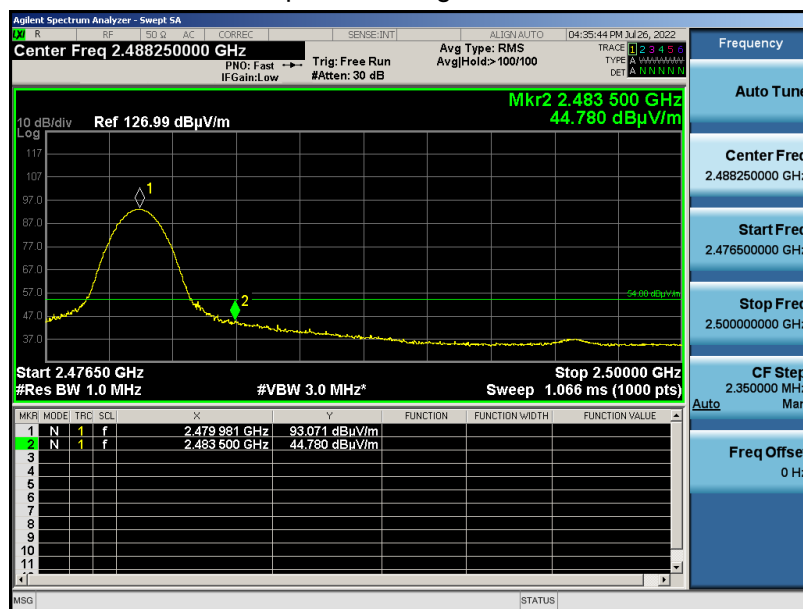

**RESULT: PASS**

Any report having not been signed by authorized approver, or having been altered without authorization, or having not been stamped by the "Dedicated Testing/Inspection Stamp" is deemed to be invalid. Copying or excerpting portion of, or altering the content of the report is not permitted without the written authorization of AGC. The test results presented in the report apply only to the tested sample. Any objections to report issued by AGC should be submitted to AGC within 15days after the issuance of the test report. Further enquiry of validity or verification of the test report should be addressed to AGC by agc01@agccert.com.

EUT	Label Printer	Model Name	NIIMBOT B1
Temperature	25°C	Relative Humidity	55%
Pressure	985hPa	Test Voltage	Normal Voltage
Test Mode	Mode 3	Antenna	Vertical

Test Graph for Peak Measurement

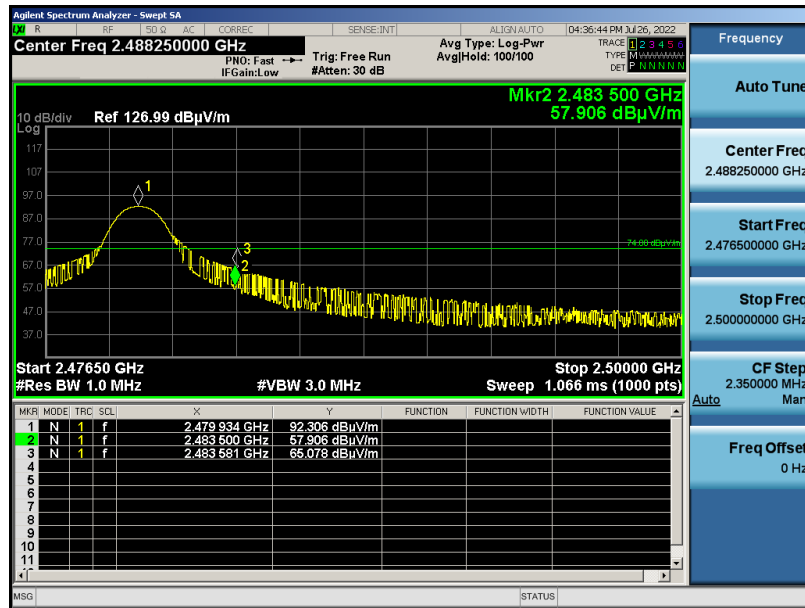

Test Graph for Average Measurement

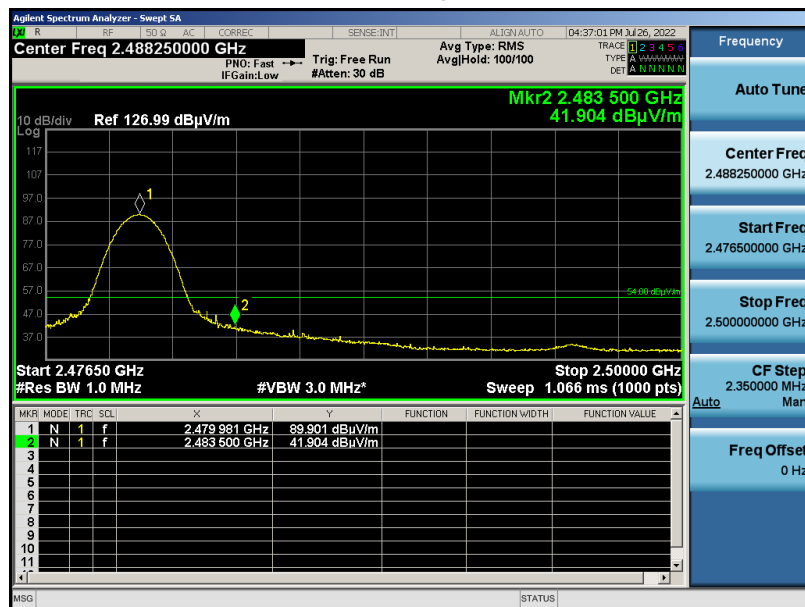

**RESULT: PASS**

Any report having not been signed by authorized approver, or having been altered without authorization, or having not been stamped by the "Dedicated Testing/Inspection Stamp" is deemed to be invalid. Copying or excerpting portion of, or altering the content of the report is not permitted without the written authorization of AGC. The test results presented in the report apply only to the tested sample. Any objections to report issued by AGC should be submitted to AGC within 15days after the issuance of the test report. Further enquiry of validity or verification of the test report should be addressed to AGC by agc01@agccert.com.

## 11. NUMBER OF HOPPING FREQUENCY

### 11.1. MEASUREMENT PROCEDURE

The EUT shall have its hopping function enabled. Use the following spectrum analyzer settings:

1. Span: The frequency band of operation. Depending on the number of channels the device supports, it may be necessary to divide the frequency range of operation across multiple spans, to allow the individual channels to be clearly seen.
2. RBW: To identify clearly the individual channels, set the RBW to less than 30% of the channel spacing or the 20 dB bandwidth, whichever is smaller.
3. VBW  $\geq$  RBW. Sweep: Auto. Detector function: Peak. Trace: Max hold.
4. Allow the trace to stabilize.

### 11.2. TEST SETUP (BLOCK DIAGRAM OF CONFIGURATION)

Same as described in section 8.2

### 11.3. MEASUREMENT EQUIPMENT USED

The same as described in section 6

### 11.4. LIMITS AND MEASUREMENT RESULT

Test Data of Number of Hopping Frequency			
Test Mode	Number of Hopping Frequency	Limits	Pass or Fail
GFSK Hopping	79	$\geq 15$	Pass

### Test Graphs of Number of Hopping Frequency

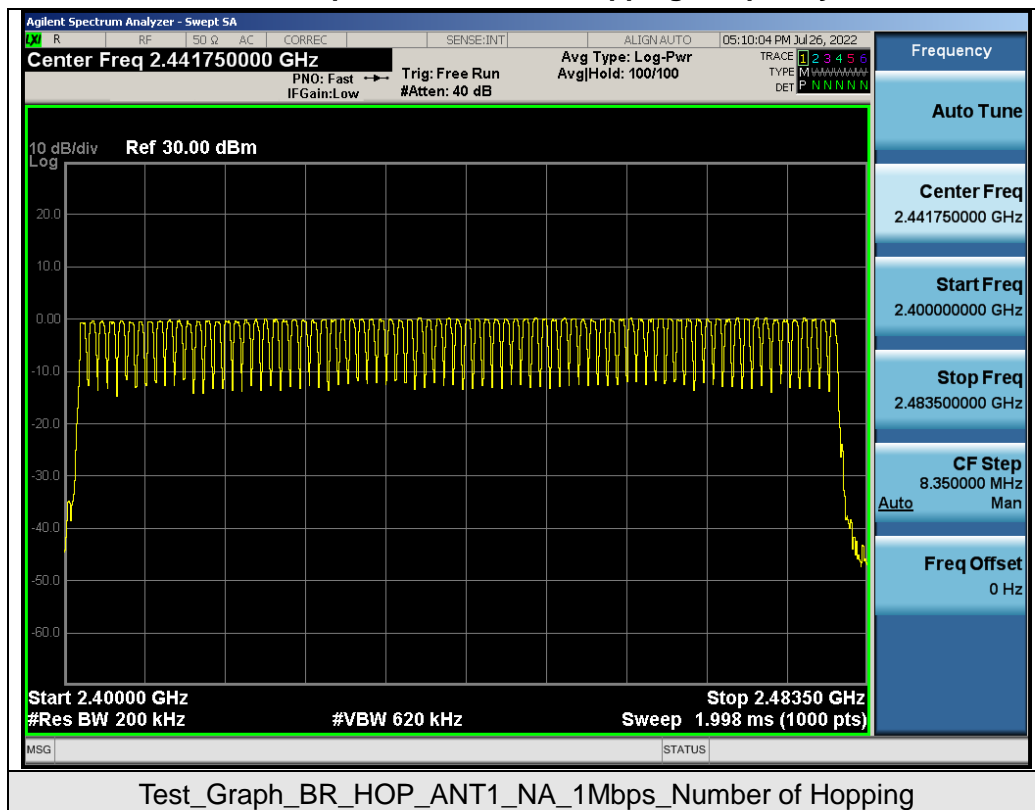

Any report having not been signed by authorized approver, or having been altered without authorization, or having not been stamped by the "Dedicated Testing/Inspection Stamp" is deemed to be invalid. Copying or excerpting portion of, or altering the content of the report is not permitted without the written authorization of AGC. The test results presented in the report apply only to the tested sample. Any objections to report issued by AGC should be submitted to AGC within 15days after the issuance of the test report. Further enquiry of validity or verification of the test report should be addressed to AGC by agc01@agccert.com.

## 12. TIME OF OCCUPANCY (DWELL TIME)

### 12.1. MEASUREMENT PROCEDURE

The EUT shall have its hopping function enabled. Use the following spectrum analyzer settings:

1. Span: Zero span, centered on a hopping channel.
2. RBW shall be  $\leq$  channel spacing and where possible RBW should be set  $\gg 1 / T$ , where T is the expected dwell time per channel.
3. Sweep: As necessary to capture the entire dwell time per hopping channel; where possible use a video trigger and trigger delay so that the transmitted signal starts a little to the right of the start of the plot. The trigger level might need slight adjustment to prevent triggering when the system hops on an adjacent channel; a second plot might be needed with a longer sweep time to show two successive hops on a channel.
4. Detector function: Peak. Trace: Max hold.
5. Use the marker-delta function to determine the transmit time per hop.
6. Repeat the measurement using a longer sweep time to determine the number of hops over the period specified in the requirements. The sweep time shall be equal to, or less than, the period specified in the requirements. Determine the number of hops over the sweep time and calculate the total number of hops in the period specified in the requirements, using the following equation:  
(Number of hops in the period specified in the requirements) = (number of hops on spectrum analyzer)  $\times$  (period specified in the requirements / analyzer sweep time).
7. The average time of occupancy is calculated from the transmit time per hop multiplied by the number of hops in the period specified in the requirements.

### 12.2. TEST SETUP (BLOCK DIAGRAM OF CONFIGURATION)

Same as described in section 8.2

### 12.3. MEASUREMENT EQUIPMENT USED

The same as described in section 6

### 12.4. LIMITS AND MEASUREMENT RESULT

Test Data of Dwell Time					
Channel	Time of Pulse for DH5 (ms)	Number of hops in the period specified in the requirements	Sweep Time (ms)	Limit (ms)	Pass or Fail
2402	2.820	28.0*4	315.840	400	Pass
2441	2.820	29.0*4	327.120	400	Pass
2480	2.822	28.0*4	316.064	400	Pass

Any report having not been signed by authorized approver, or having been altered without authorization, or having not been stamped by the "Dedicated Testing/Inspection Stamp" is deemed to be invalid. Copying or excerpting portion of, or altering the content of the report is not permitted without the written authorization of AGC. The test results presented in the report apply only to the tested sample. Any objections to report issued by AGC should be submitted to AGC within 15days after the issuance of the test report. Further enquiry of validity or verification of the test report should be addressed to AGC by agc01@agccert.com.

### Test Graphs of Dwell Time

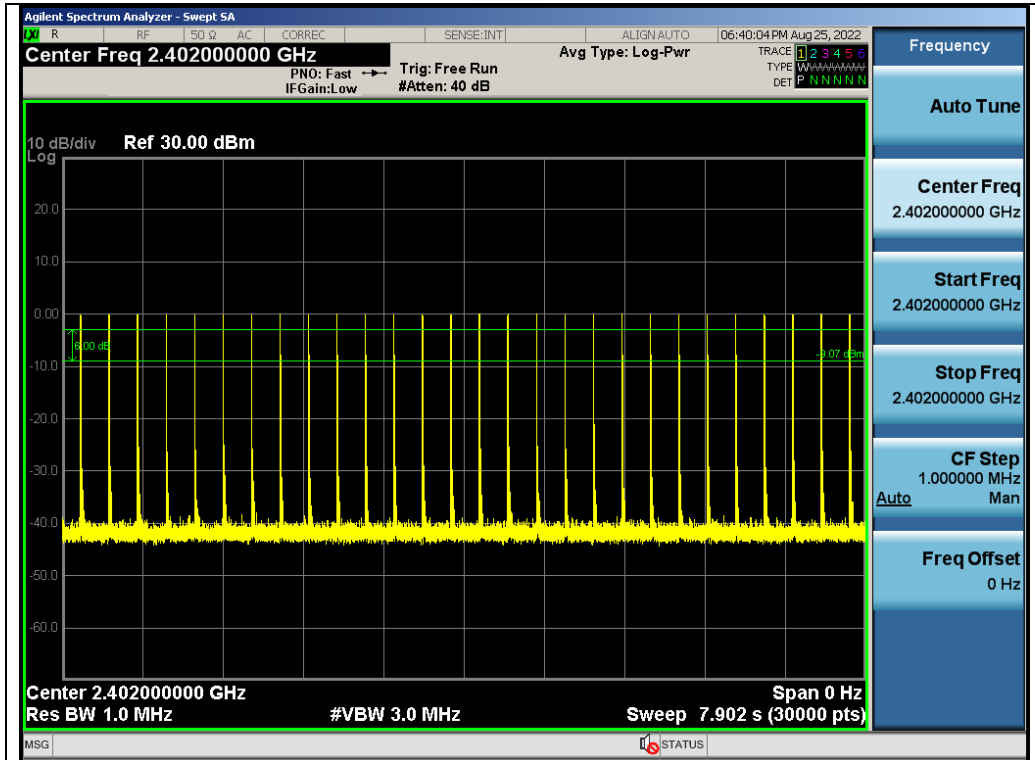

Test\_Graph\_BR\_HOP\_ANT1\_NA\_1Mbps\_2402\_Number of Burst

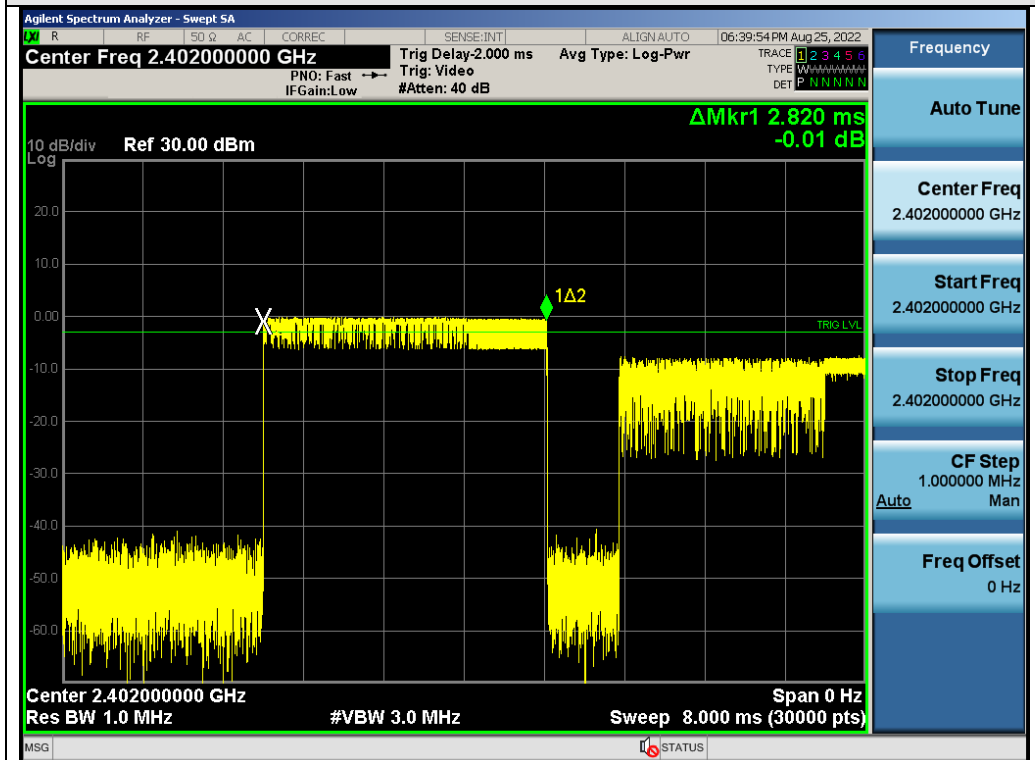

Test\_Graph\_BR\_HOP\_ANT1\_NA\_1Mbps\_2402\_Time per Burst

Any report having not been signed by authorized approver, or having been altered without authorization, or having not been stamped by the "Dedicated Testing/Inspection Stamp" is deemed to be invalid. Copying or excerpting portion of, or altering the content of the report is not permitted without the written authorization of AGC. The test results presented in the report apply only to the tested sample. Any objections to report issued by AGC should be submitted to AGC within 15days after the issuance of the test report. Further enquiry of validity or verification of the test report should be addressed to AGC by agc01@agccert.com.

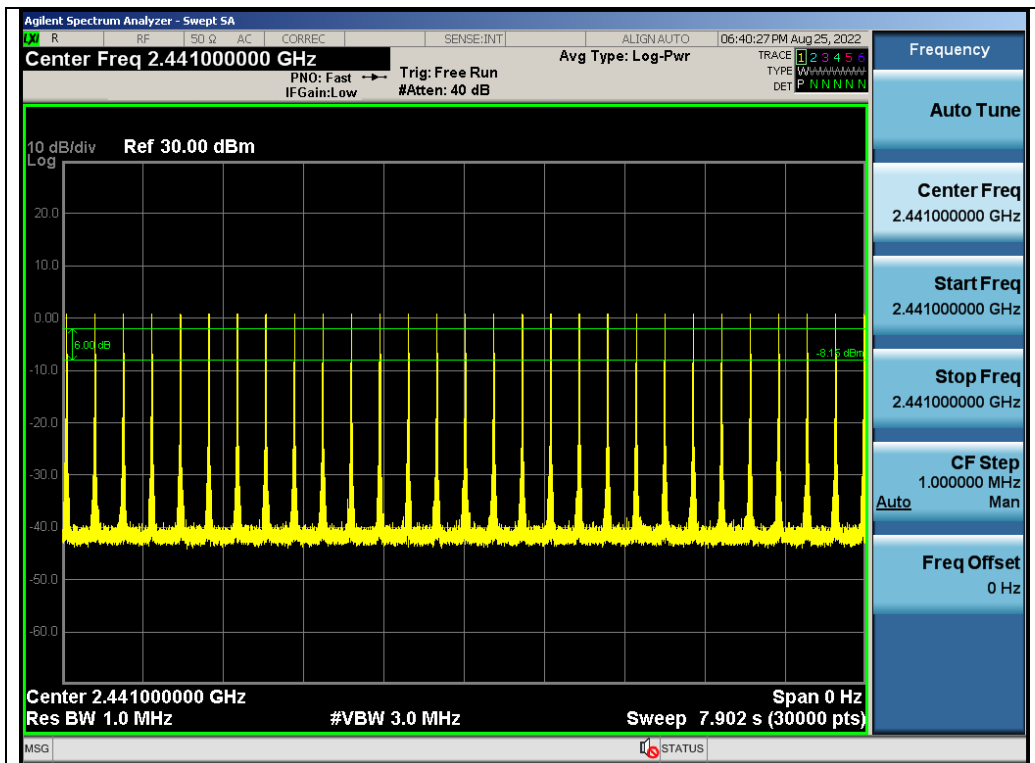

Test\_Graph\_BR\_HOP\_ANT1\_NA\_1Mbps\_2441\_Number of Burst

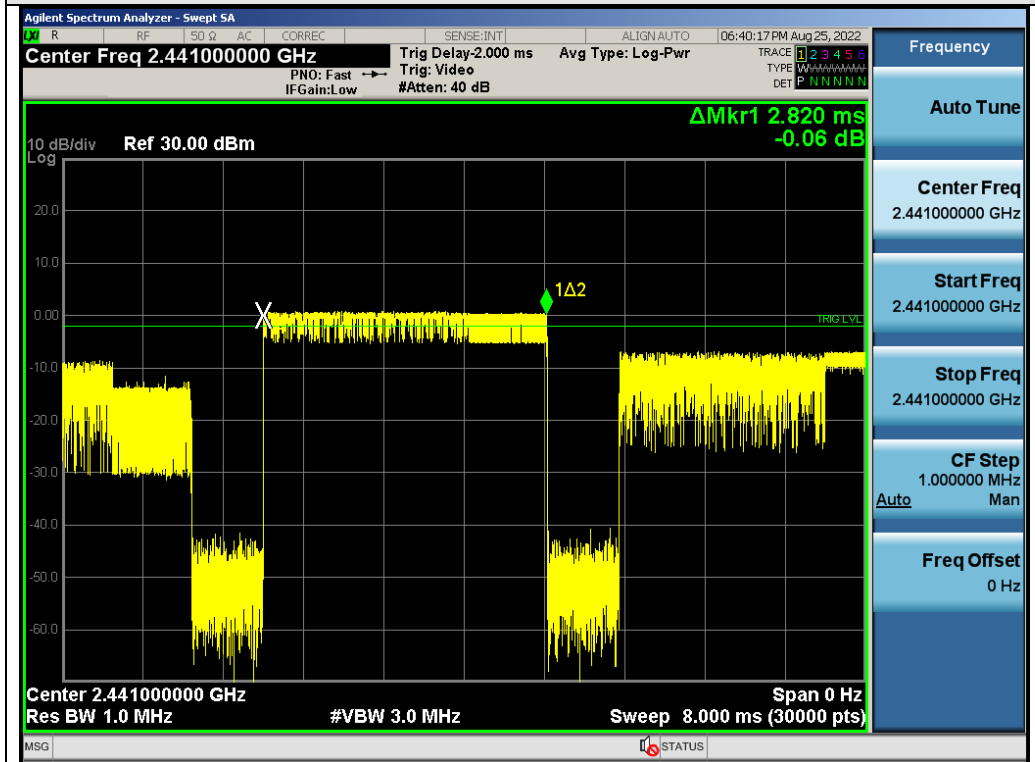

Test\_Graph\_BR\_HOP\_ANT1\_NA\_1Mbps\_2441\_Time per Burst

Any report having not been signed by authorized approver, or having been altered without authorization, or having not been stamped by the "Dedicated Testing/Inspection Stamp" is deemed to be invalid. Copying or excerpting portion of, or altering the content of the report is not permitted without the written authorization of AGC. The test results presented in the report apply only to the tested sample. Any objections to report issued by AGC should be submitted to AGC within 15days after the issuance of the test report. Further enquiry of validity or verification of the test report should be addressed to AGC by agc01@agccert.com.



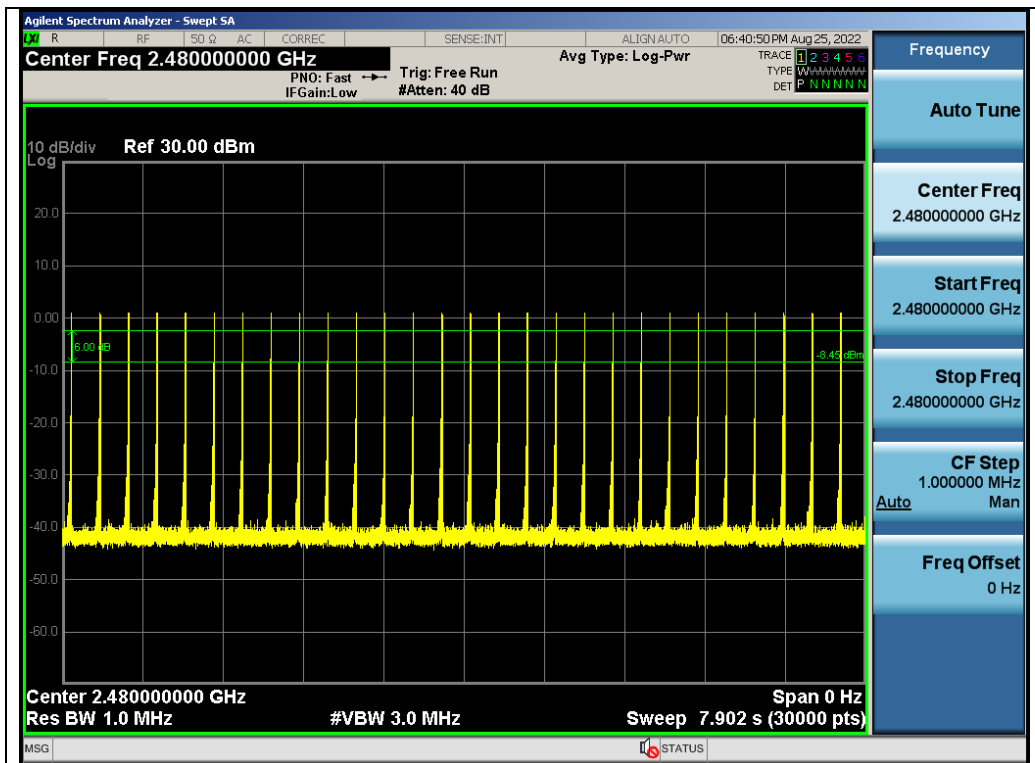

Test\_Graph\_BR\_HOP\_ANT1\_NA\_1Mbps\_2480\_Number of Burst

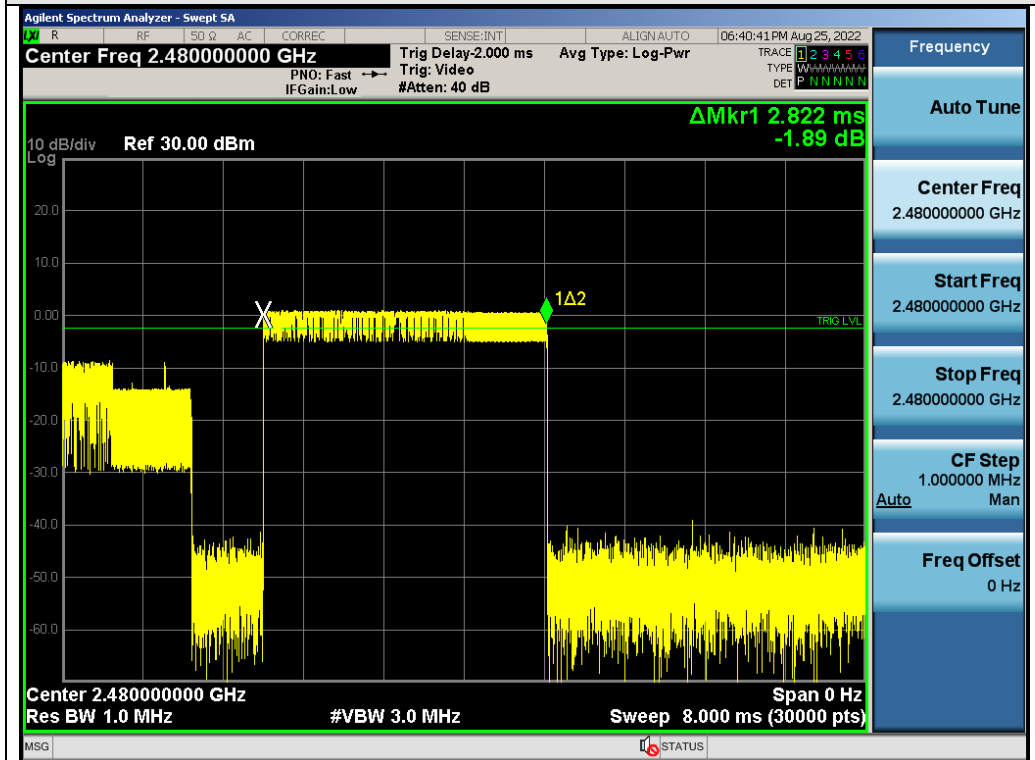

Test\_Graph\_BR\_HOP\_ANT1\_NA\_1Mbps\_2480\_Time per Burst

Any report having not been signed by authorized approver, or having been altered without authorization, or having not been stamped by the "Dedicated Testing/Inspection Stamp" is deemed to be invalid. Copying or excerpting portion of, or altering the content of the report is not permitted without the written authorization of AGC. The test results presented in the report apply only to the tested sample. Any objections to report issued by AGC should be submitted to AGC within 15days after the issuance of the test report. Further enquiry of validity or verification of the test report should be addressed to AGC by agc01@agccert.com.

### 13. FREQUENCY SEPARATION

#### 13.1. MEASUREMENT PROCEDURE

The EUT shall have its hopping function enabled. Use the following spectrum analyzer settings:

1. Span: Wide enough to capture the peaks of two adjacent channels.
  2. RBW: Start with the RBW set to approximately 30% of the channel spacing; adjust as necessary to best identify the center of each individual channel.
  3. Video (or average) bandwidth (VBW)  $\geq$  RBW.
  4. Sweep: Auto. e) Detector function: Peak. f) Trace: Max hold. g) Allow the trace to stabilize.
- Use the marker-delta function to determine the separation between the peaks of the adjacent channels.

#### 13.2. TEST SETUP (BLOCK DIAGRAM OF CONFIGURATION)

Same as described in section 6.2

#### 13.3. MEASUREMENT EQUIPMENT USED

The same as described in section 6.3

#### 13.4. LIMITS AND MEASUREMENT RESULT

Test Data of Frequency Separation			
Test Mode	Channel Separation (MHz)	Limits	Pass or Fail
GFSK Hopping	1.001	$\geq 2/3 -20\text{dB BW}$	Pass

Test Graphs of Number of Hopping Frequency

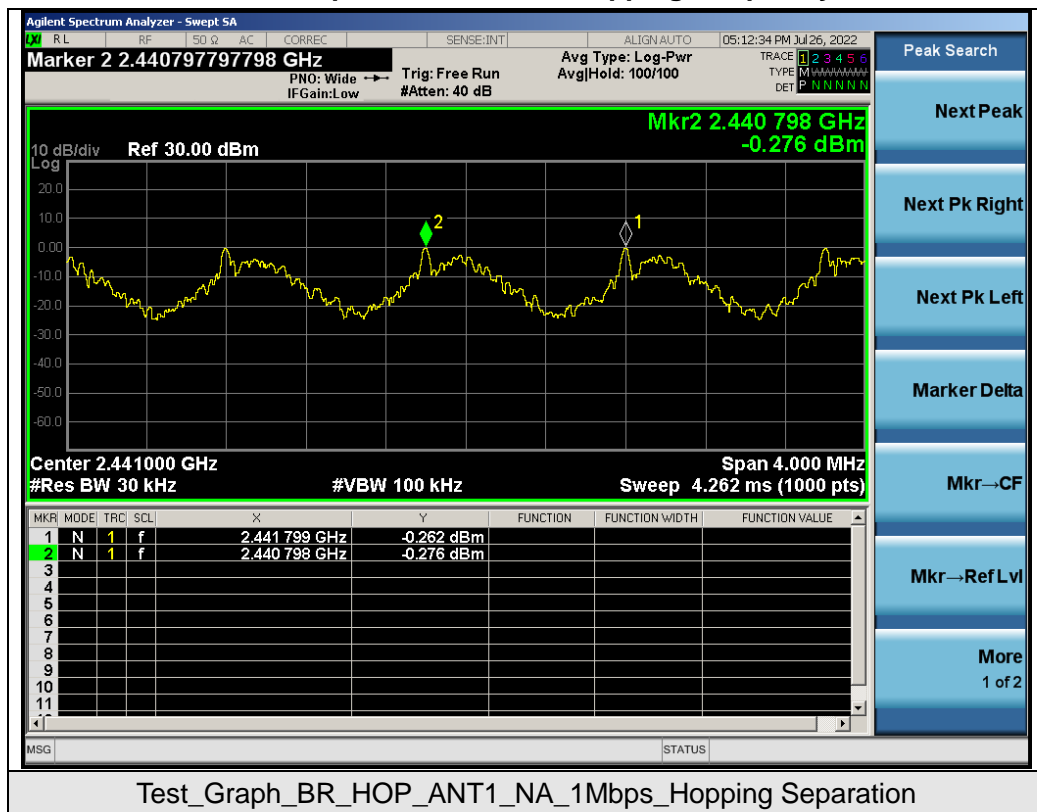

Any report having not been signed by authorized approver, or having been altered without authorization, or having not been stamped by the "Dedicated Testing/Inspection Stamp" is deemed to be invalid. Copying or excerpting portion of, or altering the content of the report is not permitted without the written authorization of AGC. The test results presented in the report apply only to the tested sample. Any objections to report issued by AGC should be submitted to AGC within 15days after the issuance of the test report. Further enquiry of validity or verification of the test report should be addressed to AGC by agc01@agccert.com.

## 14. LINE CONDUCTED EMISSION TEST

### 14.1. LIMITS OF LINE CONDUCTED EMISSION TEST

Frequency	Maximum RF Line Voltage	
	Q.P. (dB $\mu$ V)	Average (dB $\mu$ V)
150kHz~500kHz	66-56	56-46
500kHz~5MHz	56	46
5MHz~30MHz	60	50

Note: 1. The lower limit shall apply at the transition frequency.

2. The limit decreases linearly with the logarithm of the frequency in the range 0.15 MHz to 0.50 MHz.

### 14.2. BLOCK DIAGRAM OF LINE CONDUCTED EMISSION TEST

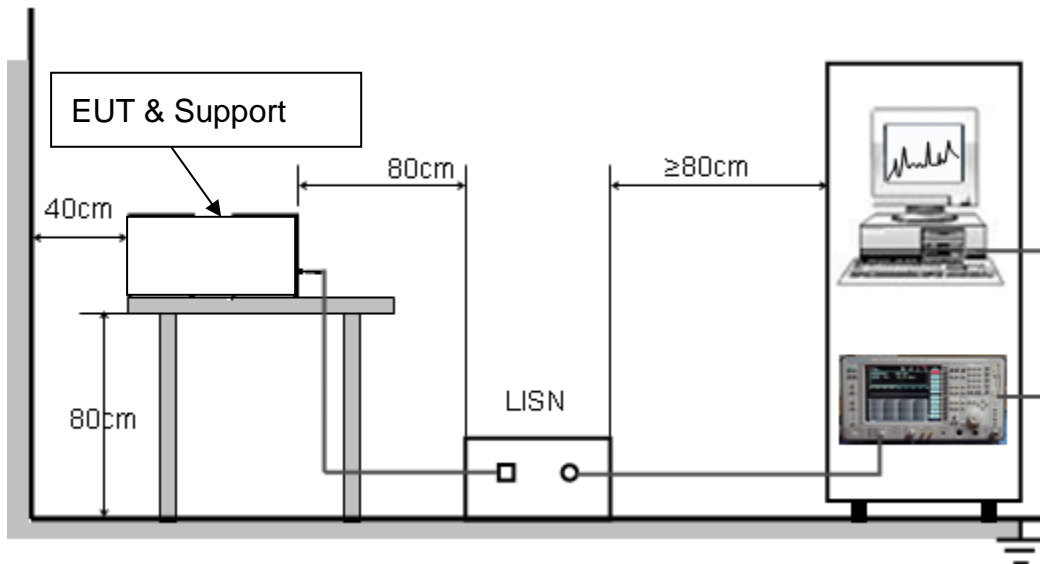

Any report having not been signed by authorized approver, or having been altered without authorization, or having not been stamped by the "Dedicated Testing/Inspection Stamp" is deemed to be invalid. Copying or excerpting portion of, or altering the content of the report is not permitted without the written authorization of AGC. The test results presented in the report apply only to the tested sample. Any objections to report issued by AGC should be submitted to AGC within 15 days after the issuance of the test report. Further enquiry of validity or verification of the test report should be addressed to AGC by [agc01@agccert.com](mailto:agc01@agccert.com).

### 14.3. PRELIMINARY PROCEDURE OF LINE CONDUCTED EMISSION TEST

1. The equipment was set up as per the test configuration to simulate typical actual usage per the user's manual. When the EUT is a tabletop system, a wooden table with a height of 0.8 meters is used and is placed on the ground plane as per ANSI C63.10 (see Test Facility for the dimensions of the ground plane used). When the EUT is a floor-standing equipment, it is placed on the ground plane which has a 3-12 mm non-conductive covering to insulate the EUT from the ground plane.
2. Support equipment, if needed, was placed as per ANSI C63.10.
3. All I/O cables were positioned to simulate typical actual usage as per ANSI C63.10.
4. All support equipment received AC120V/60Hz power from a LISN, if any.
5. The EUT received DC 5V power from adapter which received AC120V/60Hz power from a LISN.
6. The test program was started. Emissions were measured on each current carrying line of the EUT using a spectrum Analyzer / Receiver connected to the LISN powering the EUT. The LISN has two monitoring points: Line 1 (Hot Side) and Line 2 (Neutral Side). Two scans were taken: one with Line 1 connected to Analyzer / Receiver and Line 2 connected to a 50 ohm load; the second scan had Line 1 connected to a 50 ohm load and Line 2 connected to the Analyzer / Receiver.
7. Analyzer / Receiver scanned from 150 kHz to 30MHz for emissions in each of the test modes.
8. During the above scans, the emissions were maximized by cable manipulation.
9. The test mode(s) were scanned during the preliminary test.

Then, the EUT configuration and cable configuration of the above highest emission level were recorded for reference of final testing.

### 14.4. FINAL PROCEDURE OF LINE CONDUCTED EMISSION TEST

1. EUT and support equipment was set up on the test bench as per step 2 of the preliminary test.
2. A scan was taken on both power lines, Line 1 and Line 2, recording at least the six highest emissions. Emission frequency and amplitude were recorded into a computer in which correction factors were used to calculate the emission level and compare reading to the applicable limit. If EUT emission level was less – 2dB to the A.V. limit in Peak mode, then the emission signal was re-checked using Q.P and Average detector.
3. The test data of the worst case condition(s) was reported on the Summary Data page.

14.5. TEST RESULT OF LINE CONDUCTED EMISSION TEST

LINE CONDUCTED EMISSION TEST-L1

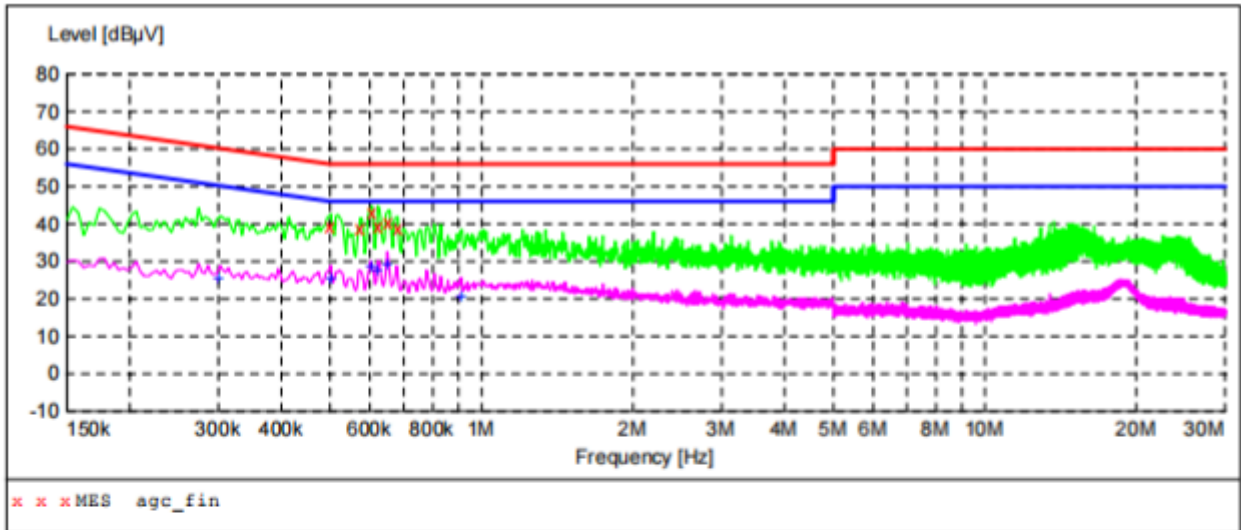

MEASUREMENT RESULT: "agc\_fin"

2022/7/25 15:50

Frequency MHz	Level dBµV	Transd dB	Limit dBµV	Margin dB	Detector	Line	PE
0.502000	39.40	5.4	56	16.6	QP	L1	GND
0.574000	38.90	5.4	56	17.1	QP	L1	GND
0.606000	43.10	5.4	56	12.9	QP	L1	GND
0.622000	39.30	5.4	56	16.7	QP	L1	GND
0.654000	40.50	5.4	56	15.5	QP	L1	GND
0.682000	38.80	5.4	56	17.2	QP	L1	GND

MEASUREMENT RESULT: "agc\_fin2"

2022/7/25 15:50

Frequency MHz	Level dBµV	Transd dB	Limit dBµV	Margin dB	Detector	Line	PE
0.302000	25.20	6.0	50	25.0	AV	L1	GND
0.502000	25.50	5.4	46	20.5	AV	L1	GND
0.602000	28.80	5.4	46	17.2	AV	L1	GND
0.622000	27.60	5.4	46	18.4	AV	L1	GND
0.650000	29.10	5.4	46	16.9	AV	L1	GND
0.910000	20.60	5.4	46	25.4	AV	L1	GND

RESULT: PASS

Any report having not been signed by authorized approver, or having been altered without authorization, or having not been stamped by the "Dedicated Testing/Inspection Stamp" is deemed to be invalid. Copying or excerpting portion of, or altering the content of the report is not permitted without the written authorization of AGC. The test results presented in the report apply only to the tested sample. Any objections to report issued by AGC should be submitted to AGC within 15days after the issuance of the test report. Further enquiry of validity or verification of the test report should be addressed to AGC by agc01@agccert.com.

LINE CONDUCTED EMISSION TEST-N

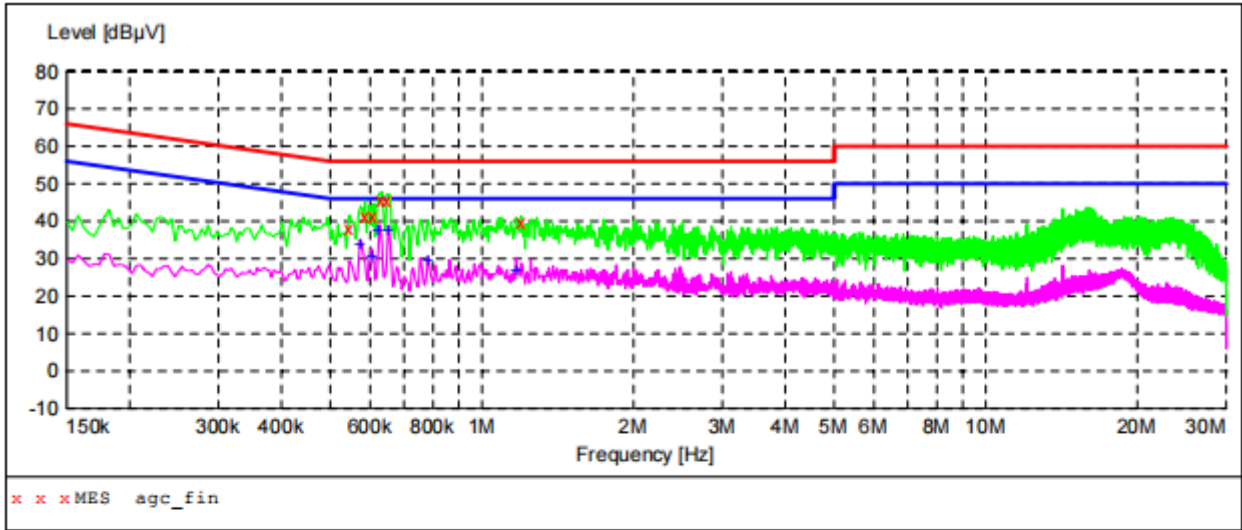

**MEASUREMENT RESULT: "agc\_fin"**

2022/7/25 15:54

Frequency MHz	Level dBµV	Transd dB	Limit dBµV	Margin dB	Detector	Line	PE
0.546000	38.30	5.4	56	17.7	QP	N	GND
0.586000	41.40	5.4	56	14.6	QP	N	GND
0.610000	41.30	5.4	56	14.7	QP	N	GND
0.634000	45.30	5.4	56	10.7	QP	N	GND
0.650000	45.60	5.4	56	10.4	QP	N	GND
1.198000	39.50	5.7	56	16.5	QP	N	GND

**MEASUREMENT RESULT: "agc\_fin2"**

2022/7/25 15:54

Frequency MHz	Level dBµV	Transd dB	Limit dBµV	Margin dB	Detector	Line	PE
0.574000	33.90	5.4	46	12.1	AV	N	GND
0.606000	30.80	5.4	46	15.2	AV	N	GND
0.626000	37.80	5.4	46	8.2	AV	N	GND
0.654000	37.40	5.4	46	8.6	AV	N	GND
0.782000	29.40	5.4	46	16.6	AV	N	GND
1.170000	26.80	5.7	46	19.2	AV	N	GND

**RESULT: PASS**

Note: All the test modes had been tested, the Mode 2 was the worst case. Only the data of the worst case would be record in this test report.

Any report having not been signed by authorized approver, or having been altered without authorization, or having not been stamped by the "Dedicated Testing/Inspection Stamp" is deemed to be invalid. Copying or excerpting portion of, or altering the content of the report is not permitted without the written authorization of AGC. The test results presented in the report apply only to the tested sample. Any objections to report issued by AGC should be submitted to AGC within 15days after the issuance of the test report. Further enquiry of validity or verification of the test report should be addressed to AGC by agc01@agccert.com.



**APPENDIX A: PHOTOGRAPHS OF TEST SETUP**

Refer to the Report No.: AGC07434220704AP02

**APPENDIX B: PHOTOGRAPHS OF EUT**

Refer to the Report No.: AGC07434220704AP03

**----END OF REPORT----**

Any report having not been signed by authorized approver, or having been altered without authorization, or having not been stamped by the “Dedicated Testing/Inspection Stamp” is deemed to be invalid. Copying or excerpting portion of, or altering the content of the report is not permitted without the written authorization of AGC. The test results presented in the report apply only to the tested sample. Any objections to report issued by AGC should be submitted to AGC within 15days after the issuance of the test report. Further enquiry of validity or verification of the test report should be addressed to AGC by [agc01@agccert.com](mailto:agc01@agccert.com).

Attestation of Global Compliance(Shenzhen)Co., Ltd

Attestation of Global Compliance(Shenzhen)Std & Tech Co., Ltd

Tel: +86-755 2523 4088 E-mail: [agc@agccert.com](mailto:agc@agccert.com) Web: <http://www.agccert.com/>





## Conditions of Issuance of Test Reports

1. All samples and goods are accepted by the Attestation of Global Compliance (Shenzhen) Co., Ltd. (the “Company”) solely for testing and reporting in accordance with the following terms and conditions. The company provides its services on the basis that such terms and conditions constitute express agreement between the company and any person, firm or company requesting its services (the “Clients”).
2. Any report issued by Company as a result of this application for testing services (the “Report”) shall be issued in confidence to the Clients and the Report will be strictly treated as such by the Company. It may not be reproduced either in its entirety or in part and it may not be used for advertising or other unauthorized purposes without the written consent of the Company. The Clients to whom the Report is issued may, however, show or send it, or a certified copy thereof prepared by the Company to its customer, supplier or other persons directly concerned. The Company will not, without the consent of the Clients, enter into any discussion or correspondence with any third party concerning the contents of the Report, unless required by the relevant governmental authorities, laws or court orders.
3. The Company shall not be called or be liable to be called to give evidence or testimony on the Report in a court of law without its prior written consent, unless required by the relevant governmental authorities, laws or court orders.
4. In the event of the improper use of the report as determined by the Company, the Company reserves the right to withdraw it, and to adopt any other additional remedies which may be appropriate.
5. Samples submitted for testing are accepted on the understanding that the Report issued cannot form the basis of, or be the instrument for, any legal action against the Company.
6. The Company will not be liable for or accept responsibility for any loss or damage however arising from the use of information contained in any of its Reports or in any communication whatsoever about its said tests or investigations.
7. Clients wishing to use the Report in court proceedings or arbitration shall inform the Company to that effect prior to submitting the sample for testing.
8. The Company is not responsible for recalling the electronic version of the original report when any revision is made to them. The Client assumes the responsibility to providing the revised version to any interested party who uses them.
9. Subject to the variable length of retention time for test data and report stored hereinto as otherwise specifically required by individual accreditation authorities, the Company will only keep the supporting test data and information of the test report for a period of six years. The data and information will be disposed of after the aforementioned retention period has elapsed. Under no circumstances shall we provide any data and information which has been disposed of after retention period. Under no circumstances shall we be liable for damage of any kind, including (but not limited to) compensatory damages, lost profits, lost data, or any form of special, incidental, indirect, consequential or punitive damages of any kind, whether based on breach of contract of warranty, tort (including negligence), product liability or otherwise, even if we are informed in advance of the possibility of such damages.

Any report having not been signed by authorized approver, or having been altered without authorization, or having not been stamped by the “Dedicated Testing/Inspection Stamp” is deemed to be invalid. Copying or excerpting portion of, or altering the content of the report is not permitted without the written authorization of AGC. The test results presented in the report apply only to the tested sample. Any objections to report issued by AGC should be submitted to AGC within 15days after the issuance of the test report. Further enquiry of validity or verification of the test report should be addressed to AGC by [agc01@agccert.com](mailto:agc01@agccert.com).