

Portable all-band radio

Operation Guide

Model: F20

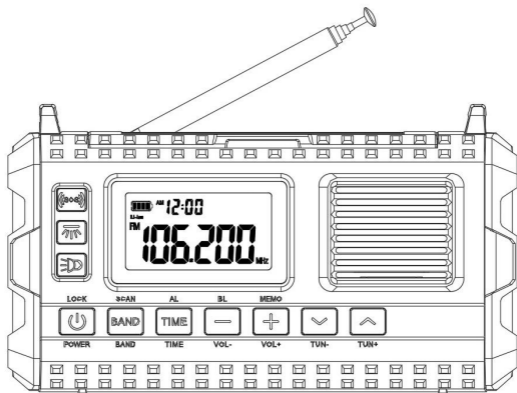

Before using this product, please carefully read the user manual.

The manual is for reference only; please refer to the actual product for specific operations.

1: Product Overview

Thank you for your purchase. This is a portable emergency multi-band radio meticulously crafted by our company. This product uses software programming to achieve digital display and reception of all-band radio broadcasts: FM, AM, SW, and WX (North American Weather Band). supporting solar charging, hand crank generator charging, and external DC5V power charging. The product is designed with a reading light, flashlight, SOS alarm, and can be used as a power bank for emergency situations. It is an essential emergency product for households and a convenient tool for outdoor activities.

2: Key Features and Functions

2.1: Independent buttons for easy operation: one-touch SOS emergency alarm, one-touch flashlight (with two brightness levels), and one-touch reading light (with two brightness levels).

2.2: Supports solar charging, hand crank generator charging, and external DC5V power charging.

2.3: Supports 3.5mm headphone audio output.

2.4: Capable of receiving all-band radio signals: FM, AM, SW, and WX (North American Weather Band) with high reception sensitivity. It features a seven-section 360-degree rotatable telescopic antenna.

2.5: Radio station search modes include: Automatic Tuning System (ATS), Full Automatic Scan and Store (SCAN), and manual tuning.

2.6: Supports 12-hour time display.

2.7: Equipped with a ϕ 40mm 4 Ω 3W speaker for loud and clear sound.

2.8: LCD digital display shows rich content: radio frequency, battery level, time, volume, band mode, and more, providing clear indicators for users.

2.9: LCD display with backlight for convenient use in the dark.

2.10: The radio's stored power can be used to charge your phone, MP3, iPad, and other devices.

This multi-functional and user-friendly radio is designed to bring you endless enjoyment of radio reception and help in various situations. Please read this manual before use and keep it for future reference.

3: Diagram of Exterior Buttons and Functions

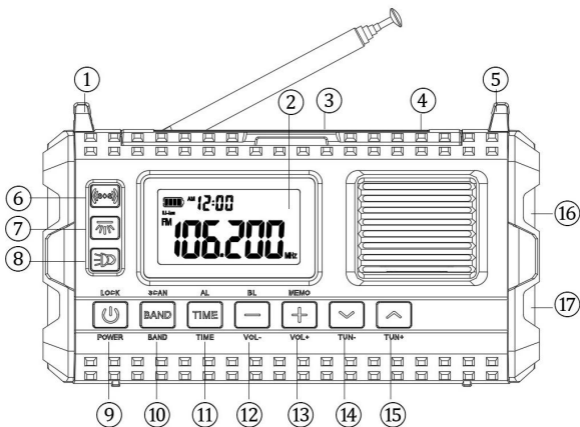

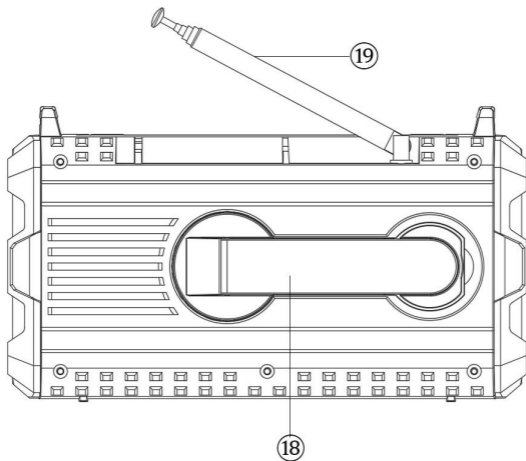



1	Left Hook	11	Time Set/Alert Switch
2	LCD Display Screen	12	Volume -/Backlight Switch
3	Reading Light On/Off	13	Volume +/Channel
4	Solar Panel	14	Channel -
5	Right Hook	15	Channel +
6	Alarm Light Switch	16	Flashlight
7	Reading Light Switch	17	Alarm Light
8	Flashlight Switch	18	Hand Crank Generator Handle
9	Power/Lock	19	Telescopic Antenna
10	Band/Auto Scan		

4: Key Function Summary Table

Button	Function Description
POWER/LOCK	Power/Key Lock 1. Long press to power on, Long press to power off 2. short press to lock keys, double-click to unlock keys.
BAND/SCAN	Band Switching/Auto Scan 1. Press to switch bands. 2. Long press for 2 seconds to start auto scan and store stations. 3. Long press for 2 seconds to switch AM step values.
TIME/AL	Time Setting/Alert 1. Press to enable/disable alert. 2. Long press for 2 seconds to enter time setting.
VOL-/BL	Volume-/Backlight On/Off 1. Decrease volume. 2. Long press for 2 seconds to toggle LCD backlight on/off.
VOL+/MEMO	Volume+/Enter Station Mode 1. Increase volume. 2. Long press for 2 seconds to enter station mode; press to select stations.
TUN-	Tune- 1. Decrease frequency. 2. Long press for 2 seconds to automatically search for stations downwards.

Button	Function Description
<p>TUN+</p>	<p>Tune+</p> <ol style="list-style-type: none"> 1. Increase frequency. 2. Long press for 2 seconds to automatically search for stations upwards.
<p>SOS ((sos))</p>	<p>Alert On/Off</p> <p>In power-on mode, press to start/stop the alert.</p>
<p>Reading Light</p> 	<p>Reading Light On/Off</p> <ol style="list-style-type: none"> 1. Press once to turn on the reading light. 2. Press again to dim the light. 3. Press a third time to turn off the light.
<p>Flashlight</p> 	<p>Flashlight On/Off</p> <ol style="list-style-type: none"> 1. Press once to turn on the flashlight. 2. Press again to the flashing mode. 3. Press a third to SOS status. 4. Press a fourth time to turn off the flashlight.
<p>TYPE-C Port</p>	<p>Power Input</p> <p>For charging the device.</p>
<p>USB Port</p>	<p>Power Output</p> <p>For charging external devices.</p>
	<p>Headphone Jack</p> <p>For connecting headphones.</p>

5: LCD Display Symbols

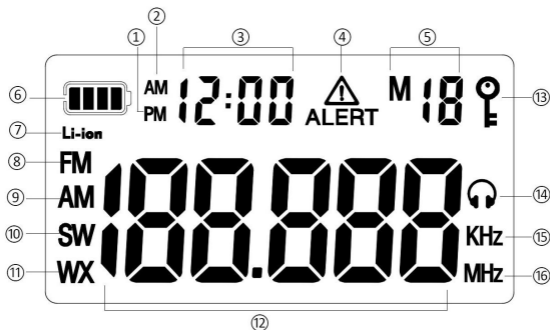

1	PM Time Indicator	9	AM (Amplitude Modulation)
2	AM Time Indicator	10	SW (Shortwave)
3	Time Display	11	WX (Weather Band)
4	Alert Indicator	12	Radio Frequency Display
5	Station Storage/Recall Indicator	13	Lock Indicator
6	Charging & Battery Level Display	14	Headphone Indicator
7	Lithium Battery Indicator	15	AM Unit
8	FM (Frequency Modulation)	16	FM/SW/WX Unit

6: Radio Operation Guide

6.1: Turning the Radio On and Off

This product is equipped with a 10,000mAh battery. To power on the device, long press the **【POWER/LOCK】** button. Each time you turn on the radio, it will default to WX reception mode, with the “WX” symbol flashing, indicating that it is automatically searching for weather alerts. Press the **【BAND】** button to select the desired reception mode: FM for frequency modulation, AM for amplitude modulation, SW for shortwave, and WX for the North American weather band.

To turn off the device while it is on, Long press the **【POWER/LOCK】** button.

Note: It is recommended to fully charge the device before using it for the first time.

6.2: Locking and Unlocking the Radio

To prevent accidental changes to settings while listening to broadcasts, you can use the lock feature.

- **Locking:** In the powered-on state, short press the **【POWER/LOCK】** button for 2 seconds. The screen will display a lock symbol “

6.3: Selecting Broadcast Reception Modes

While the device is powered on, press the **【BAND/SCAN】** button to cycle through and select the desired reception mode.

Reception Mode	Reception Range	Minimum Step Size
FM (Frequency Modulation)	87.5 - 108 MHz	0.1 MHz
AM (Amplitude Modulation)	520 - 1710 kHz (Step: 10 kHz) 522 - 1710 kHz (Step: 9 kHz)	9 kHz / 10 kHz (User selectable)
SW (Shortwave)	2.30 - 23.00 MHz	0.005 MHz
WX (Weather Band)	162.400 - 162.550 MHz	-

6.4: About North American WX Weather Band:

The WX (North American Weather Band) receives seven frequencies:

- 162.400 MHz
- 162.425 MHz
- 162.450 MHz
- 162.475 MHz
- 162.500 MHz
- 162.525 MHz
- 162.550 MHz

6.4.1: Activating WX Reception:

- Long press the **【POWER/LOCK】** button to turn on the device. By default, the WX reception mode is activated with the “WX” symbol flashing, indicating that the device is in automatic search mode for weather alerts. Press the **【POWER/LOCK】** button again to turn off the device and stop automatic alert searching.

6.4.2: WX Weather Band Mode:

- When the “WX” symbol stops flashing, the display will show the current frequency. Press the **【TUN+】** or **【TUN-】** button to switch between different weather frequencies.

6.4.3: Weather Alert:

- In WX reception mode, press the **【TIME/AL】** button to enable alerts. The LCD screen will display “ ALERT On,” indicating that automatic alerts are active. You can set the automatic alert timer to: ON/4h/8h/12h/16h/20h/24h. After the set time, the device will automatically turn off. To exit the alert mode, press the **【TIME/AL】** button or the **【BAND/SCAN】** button.

6.5: Listening to Radio Broadcasts:

6.5.1: Using the Antenna:

6.5.1.1: FM/SW/WX Reception:

- Extend the antenna for optimal reception of FM, SW, and WX broadcasts. The device features a seven-section, 360-degree rotating telescopic antenna. Adjust the length and direction of the antenna to find the best reception position. *Tip: If you experience strong interference, try shortening the antenna.*

6.5.1.2: AM (Medium Wave) Reception:

- The device uses an internal magnetic antenna for AM reception. Because the magnetic antenna has directional sensitivity, rotating the device can help find the best reception position.

6.5.2: Searching for Stations:

6.5.2.1: Manual Search:

- In radio mode, press the **【TUN+】** or **【TUN-】** button to increment or decrement the frequency by the smallest step value.

6.5.2.2: Automatic Search:

- In FM/AM/SW mode, long press the **【TUN+】** or **【TUN-】** button for 2 seconds to start automatic searching. The device will search up

or down by the smallest step value and stop when a clear station is found, playing the selected frequency.

6.5.2.3: Full Automatic Scan:

- In FM/AM/SW mode, long press the **【BAND/SCAN】** button for 2 seconds to enter full automatic scan mode. The device will scan from the lowest to the highest frequency, automatically storing stations in order. After completing the scan, the device will stop and play the first stored station.

6.5.3: Manual Station Selection:

- After performing a full automatic scan (see 6.5.2.3), in FM/AM/SW mode, long press the **【VOL+】** button for 2 seconds to enter station selection mode. The LCD screen will show the station number in the top right corner. Press the **【VOL+】** or **【VOL-】** button to select your preferred station.

6.5.4: AM Step Value Switching (9 kHz/10 kHz):

6.5.4.1: Step Value Adjustment:

- Long press the **【POWER】** button to turn on the device. When the “WX” symbol is displayed, long press the **【BAND】** button for 2 seconds to switch between 9 kHz and 10 kHz step values. The selected step value will be confirmed after 2 seconds.

Note: In North and South America (e.g., the USA, Canada, Mexico), the AM step value must be set to 10 kHz. In other regions, it should be set to 9 kHz.

6.6: Volume Adjustment:

- Press the **【VOL+】** or **【VOL-】** button to adjust the volume up or down. When the volume level is displayed, you can long press the **【VOL+】** or **【VOL-】** button for a quick volume adjustment. The volume levels range from 00 to 16.

7: SOS Alarm Sound Operation

To activate the SOS alarm, first long press the **【POWER】** button to turn on the device. The SOS alarm can only be used when the device is powered on.

7.1: Activating the Alarm Sound:

- Press button “**((SOS))**” to activate the SOS alarm. This will trigger a loud alarm sound, and the red LED light will flash in sync with the alarm, At the same time, the flashlight flashes.

7.2: Deactivating the Alarm Sound:

- While the alarm is sounding, press button “**((SOS))**” again to turn off the alarm.



8: Light Usage Instructions

To activate the SOS alarm, you must first long press the **【POWER】** button to turn on the device. The light functions can only be used when the device is powered on. This product features three types of lights: LCD backlight, reading light, and flashlight. Here's how to operate them:





8.1: LCD Backlight:

- The LCD backlight can be toggled on or off. To operate:
 - While the device is on, long press the **【VOL-/BL】** button for 2 seconds. The display will show either “OFF” or “ON”.
 - “OFF” means the LCD backlight is turned off.
 - “ON” means the backlight is on. If the backlight is on and no buttons are pressed for about 15 seconds, it will automatically turn off. Press any button to turn the backlight back on.
 - Each long press of the **【VOL-/BL】** button switches between these two modes.
 -

8.2: Reading Light On/Off:

- The reading light has four settings. When the device is not locked:
 - Press button “” once: Turns on the reading light.
 - Press button “” a second time: Dims the light.
 - Press button “” a third time: Turns off the reading light.



8.3: Flashlight:

- The flashlight has three settings. When the device is not locked:
 - Press button “” once: Turns on the flashlight.
 - Press button “” a second time: Activates the flashing mode.
 - Press button “” a third time: to SOS status.
 - Press button “” a fourth time: Turns off the flashlight.

9: Charging the Radio

It is recommended to use a charging device with an output voltage of DC5V 2A to prevent damage to the lithium battery or the device. This device supports three charging methods:

9.1: Hand Crank Generator Charging:



Open the hand crank handle and turn it clockwise or counterclockwise to charge the lithium battery. The charging indicator on the screen will show a “” symbol blinking, indicating that charging is in progress. Once fully charged, the charging indicator will show a “” symbol and stop blinking, with the battery level displayed as full.

9.2: External DC5V Power Charging:

Insert a DC5V power source into the “TYPE-C USB” charging port. The charging indicator on the screen will show a “” symbol blinking, indicating that charging is in progress. Once fully charged, the charging

indicator will show a “” symbol and stop blinking, with the battery level displayed as full. The typical charging time is approximately 10 hours.

9.3: Solar Charging::

Place the product in a location where it is exposed to sunlight, with the solar panel facing the sun. The charging indicator on the screen will show a “” symbol blinking, indicating that it is charging. Once fully charged, the charging indicator will display a “” symbol and stop blinking, with the battery level shown as full.

10: About USB External Charging Power Bank

Using the charging methods mentioned above—solar panel, hand crank generator, or external DC5V power—the stored energy in the radio can be used to charge your phone, MP3 player, or iPad. Before charging, pull back the rubber cover on the right side of the radio, insert one end of the charging cable into the standard USB port, and connect the other end to the device you wish to charge.

Power Bank Function Parameters::

- 1) : TYPE-C Input: 5V/2A. The power bank will automatically protect against excessive current, high voltage, or short circuits.
- 2) : USBA Output: 5V/2A. The power bank will automatically protect against excessive current, high voltage, low radio battery, or prolonged charging.
- 3) : Supports simultaneous charging of the radio and external devices.

11: Time Adjustment

While the device is on, long press the **【TIME/AL】** button for 2 seconds to enter the time adjustment mode. The hour display “” will start blinking. Press or hold the **【TUN+】** or **【TUN-】** button to adjust the hour. Press

the **【TIME/AL】** button again, and the minute display "" will start blinking. Press or hold the **【TUN+】** or **【TUN-】** button to adjust the minutes. Once you have set the current time, press the **【TIME/AL】** button to confirm, or the device will automatically confirm the adjustment after 5 seconds of inactivity.

Note: The radio uses a 12-hour time format. "AM" indicates morning hours, while "PM" indicates afternoon hours.

12: Main Technical Specifications

Reception Frequency Range	FM: 87.5-108MHZ AM: 522-1710KHZ (9KHZ) /520-1710KHZ (10KHZ) SW: 2.30-23.00MHZ WX : 162 400-162.550MHZ
Reception Sensitivity	FM 8dB AM 86dB SW 30dB
Signal-to-Noise Ratio	FM 38 dB AM 30 dB SW 35 dB
Max Current	680mA
Static Current	160uA
USBA Port Output Current	2A
Operating Voltage	3.0V-4.2V
Max Power Consumption	1.3W
Device Dimensions	95*168*73mm
Device Weight	545g

13: Important Safety Guidelines

Before using this product, please ensure you follow these basic safety tips to guarantee safe and reliable operation:

- **Avoid Prolonged Sun Exposure:** Do not expose the product to direct sunlight for more than one hour to prevent potential damage to the battery.
- **Charging Interference:** Charging the radio may cause signal interference. For an optimal listening experience, it is recommended to use the radio after the charging process is complete.
- **Resetting the Device:** If the device malfunctions or displays errors, restart it by using a 20mm long object to press the reset button located inside the headphone jack while the device is powered on.
- **Handle with Care:** Do not drop, impact, or apply excessive pressure to the product. Avoid exposing it to such physical stressors to maintain its functionality and longevity.
- **If the battery is low due to long periods of inactivity,** please use the hand crank to charge for 5-10 minutes to activate the lithium battery.
- **It is recommended to use a charging device with an output voltage of 5V/2A to avoid damage to the lithium battery or the device.**
- **For safe transportation, the product is shipped with low battery power. Please fully charge it before use.**
- **Do not drop, impact, or apply heavy pressure on the product.**
- **Keep the product away from rain, moisture, and any liquids.**
- **Do not disassemble, repair, or modify the product yourself.**
- **Do not allow foreign objects to enter the device.**

FCC STATEMENT :

This device complies with Part 15 of the FCC Rules.

Operation is subject to the following two conditions:

- (1) This device may not cause harmful interference, and
- (2) This device must accept any interference received, including interference that may cause undesired operation.

Warning: Changes or modifications not expressly approved by the party responsible for compliance could void the user's authority to operate the equipment.

NOTE: This equipment has been tested and found to comply with the limits for a Class B digital device, pursuant to Part 15 of the FCC Rules. These limits are designed to provide reasonable protection against harmful interference in a residential installation. This equipment generates uses and can radiate radio frequency energy and, if not installed and used in accordance with the instructions, may cause harmful interference to radio communications. However, there is no guarantee that interference will not occur in a particular installation. If this equipment does cause harmful interference to radio or television reception, which can be determined by turning the equipment off and on, the user is encouraged to try to correct the interference by one or more of the following measures:

- Reorient or relocate the receiving antenna.

- Increase the separation between the equipment and receiver.

- Connect the equipment into an outlet on a circuit different from that to which the receiver is connected.

- Consult the dealer or an experienced radio/TV technician for help.