



CTC Laboratories, Inc.

1-2/F., Building 2, Jiaquan Building, Guanlan High-Tech Park, Shenzhen, Guangdong, China
Tel: +86-755-27521059 Fax: +86-755-27521011 Http://www.sz-ctc.org.cn

TEST REPORT

Report No.: **CTC20210308E01**

FCC ID.....: **2ARVQ-AS087HWWS**

Applicant.....: **AUTOSLIDE PTY LTD**

Address.....: 3/413, VICTORIA STREET, WETHERILL PARK, NSW, AUSTRALIA

Manufacturer.....: AUTOSLIDE PTY LTD

Address.....: 3/413, VICTORIA STREET, WETHERILL PARK, NSW, AUSTRALIA

Product Name.....: **AUTOSLIDE Wireless Hand Wave Sensor**

Trade Mark.....: AUTOSLIDE

Model/Type reference.....: AS087HWWS

Listed Model(s): N/A



Standard.....: **FCC CFR Title 47 Part 15 Subpart C Section 15.231(a)**

Date of receipt of test sample...: Mar. 22. 2021

Date of testing.....: Mar. 22. 2021 to Apr. 07. 2021

Date of issue.....: Apr. 07. 2021

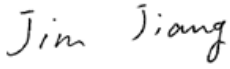
Result.....: **PASS**

Compiled by:		
(Printed name+signature)	Jim Jiang	
Supervised by:		
(Printed name+signature)	Miller Ma	
Approved by:		
(Printed name+signature)	Walter Chen	

Testing Laboratory Name **CTC Laboratories, Inc.**

Address..... 1-2/F., Building 2, Jiaquan Building, Guanlan High-Tech Park, Shenzhen, Guangdong, China

This test report may be duplicated completely for legal use with the approval of the applicant. It should not be reproduced except in full, without the written approval of our laboratory. The client should not use it to claim product endorsement by CTC. The test results in the report only apply to the tested sample. The test report shall be invalid without all the signatures of testing engineers, reviewer and approver. Any objections must be raised to CTC within 15 days since the date when the report is received. It will not be taken into consideration beyond this limit. The test report merely correspond to the test sample.



Table of Contents

Page

1. TEST SUMMARY 3

1.1. TEST STANDARDS..... 3

1.2. REPORT VERSION 3

1.3. TEST DESCRIPTION..... 3

1.4. TEST FACILITY 4

1.5. MEASUREMENT UNCERTAINTY 4

1.6. ENVIRONMENTAL CONDITIONS..... 5

2. GENERAL INFORMATION 6

2.1. CLIENT INFORMATION 6

2.2. GENERAL DESCRIPTION OF EUT 6

2.3. EUT OPERATION STATE 6

2.4. MEASUREMENT INSTRUMENTS LIST 7

3. TEST ITEM AND RESULTS 9

3.1. CONDUCTED EMISSION..... 9

3.2. RADIATED EMISSION 11

3.3. 20dB BANDWIDTH..... 18

3.4. CONTINUE TRANSMISSION TIME..... 20

3.5. DUTY CYCLE 22

3.6. ANTENNA REQUIREMENT..... 25



1. TEST SUMMARY

1.1. Test Standards

The tests were performed according to following standards:

[FCC Rules Part 15.231\(a\)](#): Periodic operation in the band 40.66–40.70 MHz and above 70MHz.

[ANSI C63.10-2013](#): American National Standard for Testing Unlicensed Wireless Devices.

1.2. Report Version

Revised No.	Date of issue	Description
01	Apr. 07. 2021	Original

1.3. Test Description

FCC Part 15 Subpart C 15.231(a)			
Test Item	Standard Section	Result	Test Engineer
Antenna Requirement	FCC 15.203	Pass	Lucy Lan
Conducted Emission	FCC 15.207	N/A	N/A
Radiated Emissions	FCC 15.205	Pass	Lucy Lan
Field Strength of the Fundamental	FCC 15.231(e)	Pass	Lucy Lan
20dB Bandwidth	FCC 15.231(c)	Pass	Lucy Lan
Continue Transmission Time	FCC 15.231(a)	Pass	Lucy Lan

Note: "N/A" Not applicable.

The measurement uncertainty is not included in the test result.



1.4. Test Facility

Address of the test laboratory

CTC Laboratories, Inc.

Add: 1-2/F., Building 2, Jiaquan Building, Guanlan High-Tech Park, Shenzhen, Guangdong, China

Laboratory accreditation

The test facility is recognized, certified, or accredited by the following organizations:

CNAS-Lab Code: L5365

CTC Laboratories, Inc. has been assessed and proved to be in compliance with CNAS-CL01 Accreditation. Criteria for Testing and Calibration Laboratories (identical to ISO/IEC17025: 2017 General Requirements) for the Competence of Testing and Calibration Laboratories.

A2LA-Lab Cert. No.: 4340.01

CTC Laboratories, Inc. EMC Laboratory has been accredited by A2LA for technical competence in the field of electrical testing, and proved to be in compliance with ISO/IEC 17025: 2017 General Requirements for the Competence of Testing and Calibration Laboratories and any additional program requirements in the identified field of testing.

Industry Canada (Registration No.: 9783A, CAB Identifier: CN0029)

CTC Laboratories, Inc. EMC Laboratory has been registered by Certification and Engineer Bureau of Industry Canada for the performance of with Registration NO.: 9783A on Jan, 2016.

FCC (Registration No.: 951311, Designation Number CN1208)

CTC Laboratories, Inc. EMC Laboratory has been registered and fully described in a report filed with the (FCC) Federal Communications Commission. The acceptance letter from the FCC is maintained in our files. Registration 951311, Aug. 26, 2017.

1.5. Measurement Uncertainty

The data and results referenced in this document are true and accurate. The reader is cautioned that there may be errors within the calibration limits of the equipment and facilities. The measurement uncertainty was calculated for all measurements listed in this test report acc. to TR-100028-01 "Electromagnetic compatibility and Radio spectrum Matters (ERM); Uncertainties in the measurement of mobile radio equipment characteristics; Part 1" and TR-100028-02 "Electromagnetic compatibility and Radio spectrum Matters (ERM); Uncertainties in the measurement of mobile radio equipment characteristics; Part 2" and is documented in the CTC Laboratories, Inc. quality system acc. to DIN EN ISO/IEC 17025. Furthermore, component and process variability of devices similar to that tested may result in additional deviation. The manufacturer has the sole responsibility of continued compliance of the device.

Below is the best measurement capability for CTC Laboratories, Inc.



Test Items	Measurement Uncertainty	Notes
Transmitter power conducted	0.42 dB	(1)
Transmitter power Radiated	2.14 dB	(1)
Conducted spurious emissions 9kHz~40GHz	1.60 dB	(1)
Radiated spurious emissions 9kHz~40GHz	2.20 dB	(1)
Conducted Emissions 9kHz~30MHz	3.20 dB	(1)
Radiated Emissions 30~1000MHz	4.70 dB	(1)
Radiated Emissions 1~18GHz	5.00 dB	(1)
Radiated Emissions 18~40GHz	5.54 dB	(1)
Occupied Bandwidth	-----	(1)

Note (1): This uncertainty represents an expanded uncertainty expressed at approximately the 95% confidence level using a coverage factor of $k=1.96$.

1.6. Environmental Conditions

During the measurement the environmental conditions were within the listed ranges:

Temperature:	20-25°C
Relative Humidity:	50-55%RH
Air Pressure:	101kPa



2. GENERAL INFORMATION

2.1. Client Information

Applicant:	AUTOSLIDE PTY LTD
Address:	3/413, VICTORIA STREET, WETHERILL PARK, NSW, AUSTRALIA
Manufacturer:	AUTOSLIDE PTY LTD
Address:	3/413, VICTORIA STREET, WETHERILL PARK, NSW, AUSTRALIA

2.2. General Description of EUT

Product Name:	AUTOSLIDE Wireless Hand Wave Sensor
Trade Mark:	AUTOSLIDE
Model/Type reference:	AS087HWWS
Listed Model(s):	N/A
Power supply:	12VDC or 6VDC from batteries
Hardware version:	V1.0
Software version:	V1.0
RF parameter	
Modulation:	OOK
Operation frequency:	433.92MHz
Channel number:	1
Antenna type:	PCB Antenna
Antenna gain:	0dBi

2.3. EUT Operation State

The EUT has been tested under typical operating condition. The Applicant provides software to control the EUT for staying in continuous transmitting mode for testing.



2.4. Measurement Instruments List

Tonscend JS0806-2 Test system					
Item	Test Equipment	Manufacturer	Model No.	Serial No.	Calibrated until
1	Spectrum Analyzer	Rohde & Schwarz	FSU26	100105	Dec. 25, 2021
2	Spectrum Analyzer	Rohde & Schwarz	FUV40-N	101331	Mar. 15, 2022
3	MXG Vector Signal Generator	Agilent	N5182A	MY47420864	Dec. 25, 2021
4	Signal Generator	Agilent	E8257D	MY46521908	Dec. 25, 2021
5	Power Sensor	Agilent	U2021XA	MY5365004	Dec. 25, 2021
6	Power Sensor	Agilent	U2021XA	MY5365006	Dec. 25, 2021
7	Simultaneous Sampling DAQ	Agilent	U2531A	TW54493510	Dec. 25, 2021
8	Climate Chamber	TABAI	PR-4G	A8708055	Dec. 25, 2021
9	Wideband Radio Communication Tester	Rohde & Schwarz	CMW500	116410	Dec. 25, 2021
10	Climate Chamber	ESPEC	MT3065	/	Dec. 25, 2021
11	300328 v2.2.2 test system	TONSCEND	v2.6	/	/

Radiated Emission and Transmitter spurious emissions					
Item	Test Equipment	Manufacturer	Model No.	Serial No.	Calibrated until
1	EMI Test Receiver	Rohde & Schwarz	ESCI	100658	Dec. 25, 2021
2	High pass filter	micro-tranics	HPM50111	142	Dec. 25, 2021
3	Log-Bicon Antenna	Schwarzbeck	CBL6141A	4180	Dec. 25, 2021
4	Ultra-Broadband Antenna	ShwarzBeck	BBHA9170	25841	Dec. 25, 2021
5	Loop Antenna	LAPLAC	RF300	9138	Dec. 25, 2021
6	Spectrum Analyzer	Rohde & Schwarz	FSU26	100105	Dec. 25, 2021
7	Horn Antenna	Schwarzbeck	BBHA 9120D	647	Dec. 25, 2021
8	Pre-Amplifier	HP	8447D	1937A03050	Dec. 25, 2021
9	Pre-Amplifier	EMCI	EMC051835	980075	Dec. 25, 2021
10	Antenna Mast	UC	UC3000	N/A	N/A
11	Turn Table	UC	UC3000	N/A	N/A
12	Cable Below 1GHz	Schwarzbeck	AK9515E	33155	Dec. 25, 2021
13	Cable Above 1GHz	Hubersuhner	SUCOFLEX102	DA1580	Dec. 25, 2021
14	Splitter	Mini-Circuit	ZAPD-4	400059	Dec. 25, 2021
15	RF Connection Cable	HUBER+SUHNER	RE-7-FL	N/A	Dec. 25, 2021
16	RF Connection Cable	Chengdu E-Microwave	---	---	Dec. 25, 2021
17	High pass filter	Compliance Direction systems	BSU-6	34202	Dec. 25, 2021

CTC Laboratories, Inc.

1-2/F., Building 2, Jiaquan Building, Guanlan High-Tech Park, Shenzhen, Guangdong, China

Tel.: (86)755-27521059

Fax: (86)755-27521011

Http://www.sz-ctc.org.cn

For anti-fake verification, please visit the official website of Certification and Accreditation Administration of the People's Republic of China : yz.cnca.cn



18	Attenuator	Chengdu E-Microwave	EMCAXX-10 RNZ-3	---	Dec. 25, 2021
19	High and low temperature box	ESPEC	MT3065	12114019	Dec. 25, 2021

Conducted Emission					
Item	Test Equipment	Manufacturer	Model No.	Serial No.	Calibrated until
1	LISN	R&S	ENV216	101112	Dec. 25, 2021
2	LISN	R&S	ENV216	101113	Dec. 25, 2021
3	EMI Test Receiver	R&S	ESCI	100658	Dec. 25, 2021

Note:1. The Cal. Interval was one year.

2. The cable loss has calculated in test result which connection between each test instruments.

3. TEST ITEM AND RESULTS

3.1. Conducted Emission

Limit

FCC CFR Title 47 Part 15 Subpart C Section 15.207:

Frequency range (MHz)	Limit (dBuV)	
	Quasi-peak	Average
0.15-0.5	66 to 56*	56 to 46*
0.5-5	56	46
5-30	60	50

Notes:

- (1) *Decreasing linearly with logarithm of the frequency.
- (2) The lower limit shall apply at the transition frequencies.
- (3) The limit decrease in line with the logarithm of the frequency in the range of 0.15 to 0.50MHz.

Test Configuration

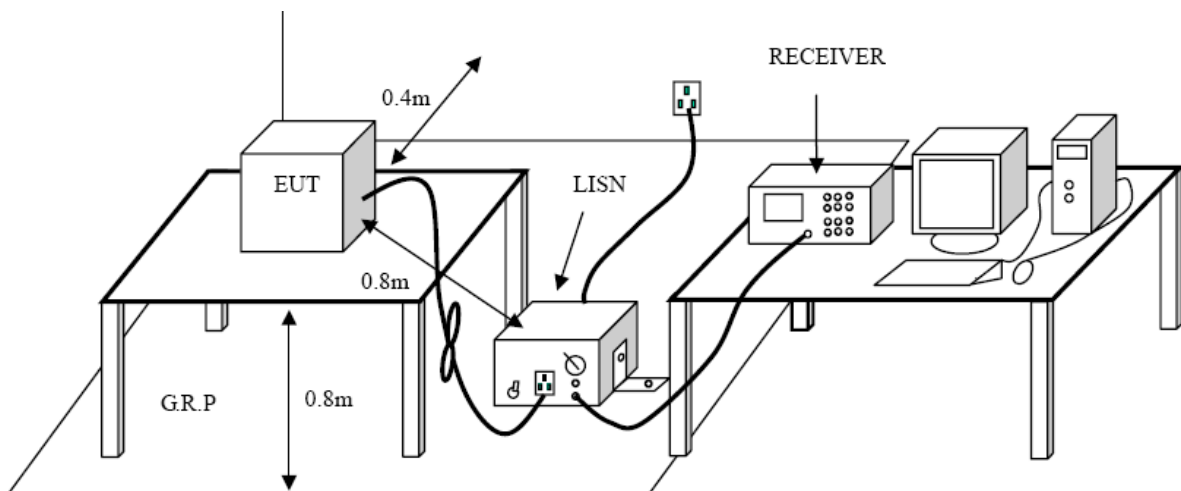

Test Procedure

1. The EUT was setup according to ANSI C63.10:2013 requirements.
2. The EUT was placed on a platform of nominal size, 1 m by 1.5 m, raised 80 cm above the conducting ground plane. The vertical conducting plane was located 40 cm to the rear of the EUT. All other surfaces of EUT were at least 80 cm from any other grounded conducting surface.
3. The EUT and simulators are connected to the main power through a line impedances stabilization network (LISN). The LISN provides a 50ohm /50uH coupling impedance for the measuring equipment.
The peripheral devices are also connected to the main power through a LISN. (Please refer to the block diagram of the test setup and photographs)
4. Each current-carrying conductor of the EUT power cord, except the ground (safety) conductor, was individually connected through a LISN to the input power source.
5. The excess length of the power cord between the EUT and the LISN receptacle were folded back and forth at the center of the lead to form a bundle not exceeding 40 cm in length.
6. Conducted Emissions were investigated over the frequency range from 0.15MHz to 30MHz using a receiver bandwidth of 9 kHz.
7. During the above scans, the emissions were maximized by cable manipulation.



Test Mode:

Please refer to the clause 2.3.

Test Results

Not applicable.



3.2. Radiated Emission

Limit

FCC CFR Title 47 Part 15 Subpart C Section 15.231(b):

The field strength of emissions from intentional radiators operated **average value** under this section shall not exceed the following

Fundamental frequency	Field strength of fundamental (millivolts/meter)	Unwanted emissions (millivolts/meter)
260 - 470 MHz	3,750 to 12,500 **	375 to 1,250 **

** linear interpolation with frequency, f, in MHz:

F is **433.92MHz**

Field strength of fundamental: Limit at 3 meters = $41.67 * F - 7083.34$

Field strength of harmonics: Limit at 3 meters = $4.167 * F - 708.334$

So the field strength of emission limits have been calculated in below table.

Fundamental Frequency (MHz)	Field Strength of Fundamental (microvolt/meter) at 3m
433.92MHz	100.82 (Peak)
433.92MHz	80.82 (Average)

Radiated Emission Limits (9 kHz~1000 MHz)

Frequency (MHz)	Field Strength (microvolt/meter)	Measurement Distance (meters)
0.009~0.490	$2400/F(KHz)$	300
0.490~1.705	$24000/F(KHz)$	30
1.705~30.0	30	30
30~88	100	3
88~216	150	3
216~960	200	3
Above 960	500	3

Radiated Emission Limit (Above 1000MHz)

Frequency (MHz)	Distance Meters(at 3m)	
	Peak	Average
Above 1000	74	54

Note:

- (1) The tighter limit applies at the band edges.
- (2) Emission Level (dBuV/m)=20log Emission Level (uV/m).

Test Configuration

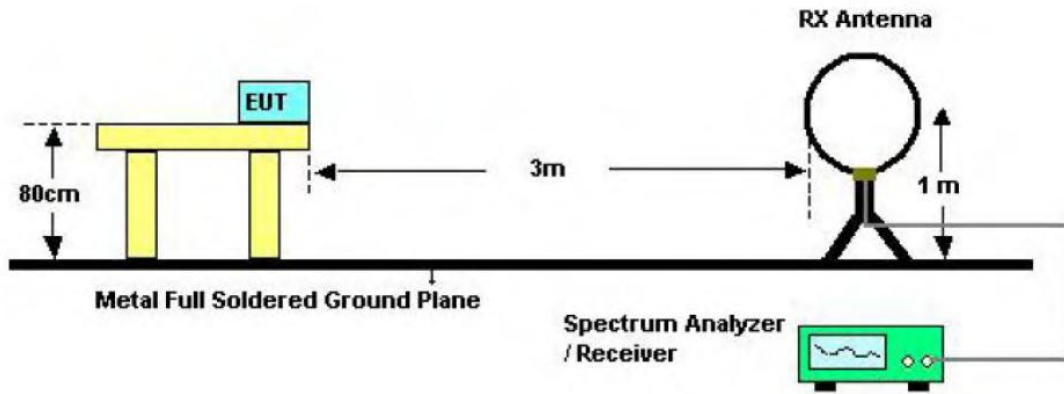

Below 30MHz Test Setup

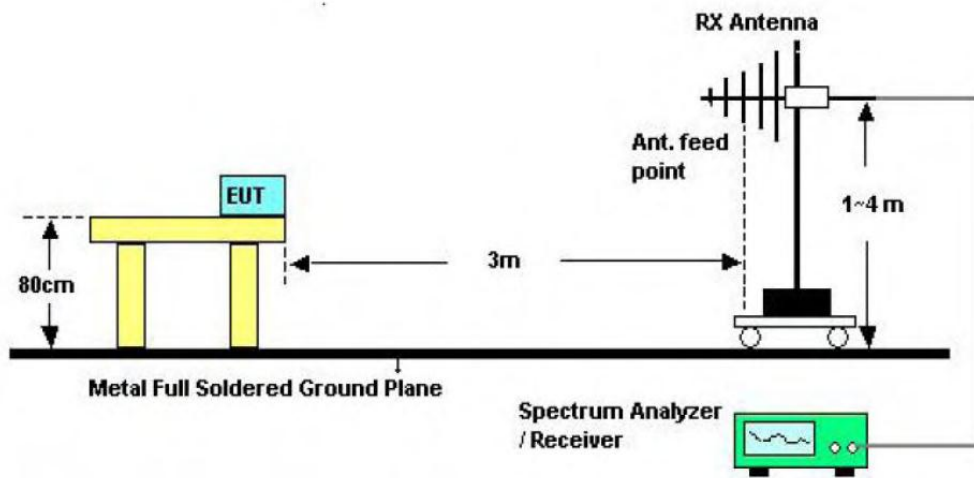

Below 1000MHz Test Setup

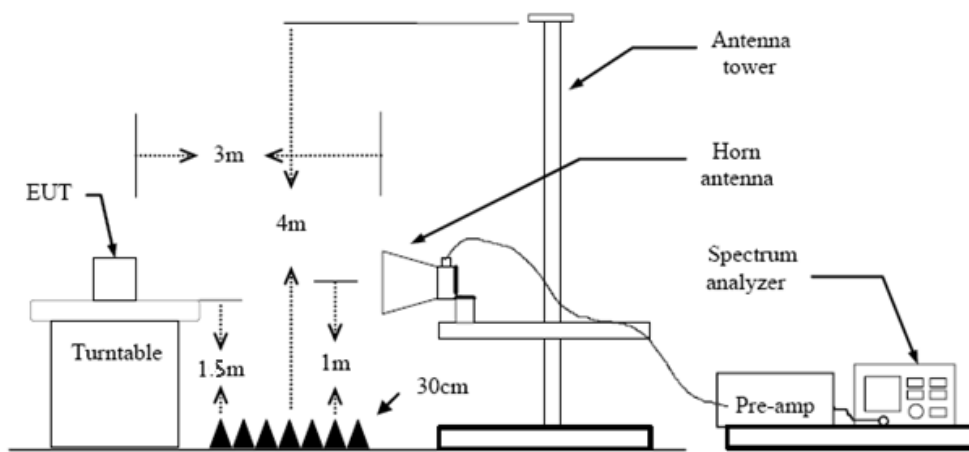

Above 1GHz Test Setup



Test Procedure

1. The EUT was setup and tested according to ANSI C63.10:2013
2. The EUT is placed on a turn table which is 0.8 meter above ground for below 1 GHz, and 1.5 m for above 1 GHz. The turn table is rotated 360 degrees to determine the position of the maximum emission level.
3. The EUT was set 3 meters from the receiving antenna, which was mounted on the top of a variable height antenna tower.
4. For each suspected emission, the EUT was arranged to its worst case and then tune the Antenna tower (from 1 m to 4 m) and turntable (from 0 degree to 360 degrees) to find the maximum reading. A pre-amp and a high pass filter are used for the test in order to get better signal level to comply with the guidelines.
5. Set to the maximum power setting and enable the EUT transmit continuously.
6. Use the following spectrum analyzer settings
 - (1) Span shall wide enough to fully capture the emission being measured;
 - (2) Below 1 GHz:
RBW=120 kHz, VBW=300 kHz, Sweep=auto, Detector function=peak, Trace=max hold;
If the emission level of the EUT measured by the peak detector is 3 dB lower than the applicable limit, the peak emission level will be reported. Otherwise, the emission measurement will be repeated using the quasi-peak detector and reported.
 - (3) From 1 GHz to 10th harmonic:
RBW=1MHz, VBW=3MHz Peak detector for Peak value.
RBW=1MHz, VBW=3MHz RMS detector for Average value.

Test Mode

Please refer to the clause 2.3.

Test Result

9 KHz~30 MHz

From 9 KHz to 30 MHz: Conclusion: PASS

Note: The amplitude of spurious emissions which are attenuated by more than 20dB below the permissible value has no need to be reported.



30MHz-1GHz

Ant. Pol.	Horizontal
Test Mode:	TX Mode 433.92MHz
Remark:	Only worse case is reported

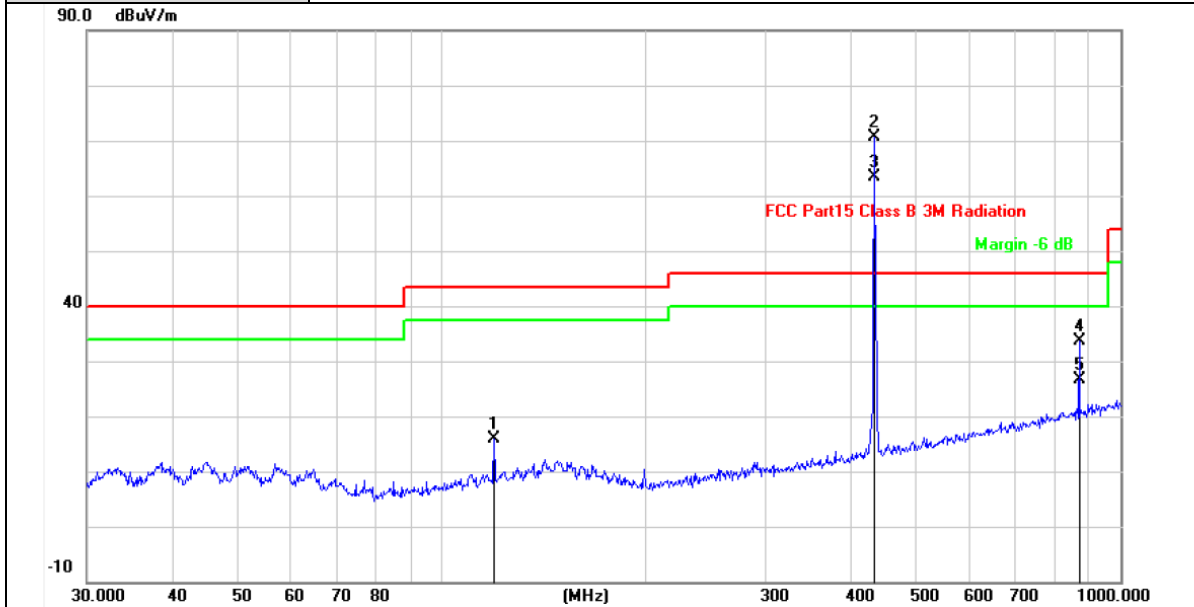

No.	Frequency (MHz)	Factor (dB/m)	Duty Cycle Factor	Reading (dBuV)	Level (dBuV/m)	Limit (dBuV/m)	Margin (dB)	Det.
1	119.4360	-19.34	/	35.22	15.88	43.50	-27.62	peak
2	434.0649	-14.87	/	85.43	70.56	100.82	-30.26	peak
3	434.0649	/	-7.12	/	63.44	80.82	-17.38	AVG
4	869.1299	-8.66	/	42.31	33.65	80.82	-47.17	peak
5	869.1302	/	-7.12	/	26.53	60.82	-34.29	AVG

Remarks:
 1. Factor (dB/m) = Antenna Factor (dB/m)+Cable Factor (dB)-Pre-amplifier Factor
 2. Margin value = Level- Limit value
 3. AVG=Peak+Duty Cycle Factor(-7.12)



Ant. Pol.	Vertical
Test Mode:	TX Mode 433.92MHz
Remark:	Only worse case is reported

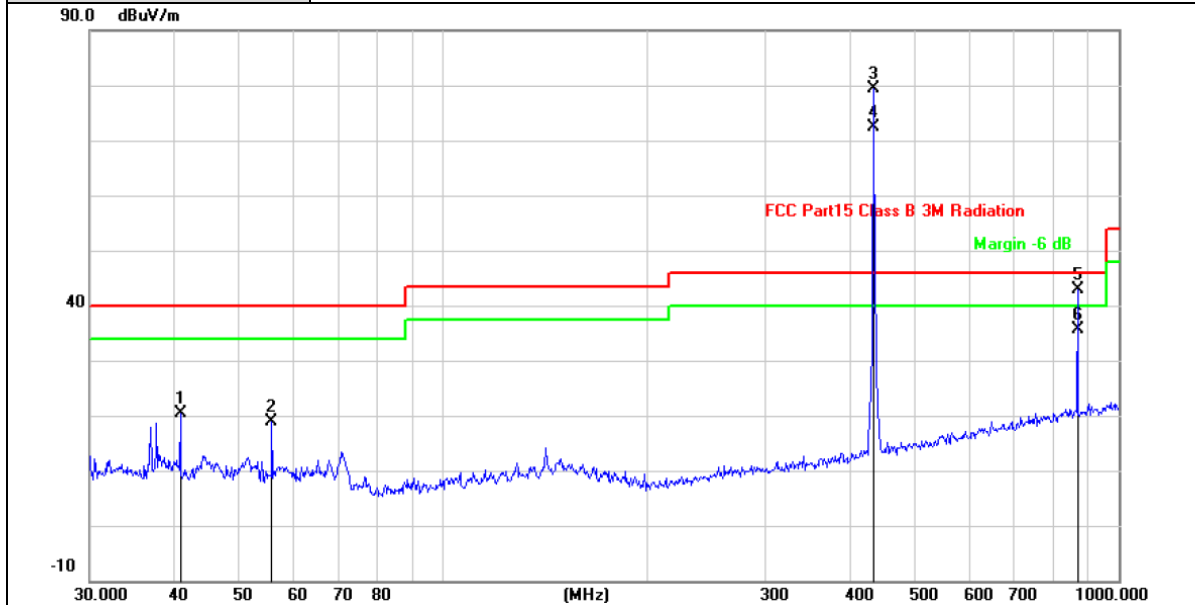

No.	Frequency (MHz)	Factor (dB/m)	Duty Cycle Factor	Reading (dBuV)	Level (dBuV/m)	Limit (dBuV/m)	Margin (dB)	Det.
1	40.8446	-17.36	/	37.85	20.49	40.00	-19.51	peak
2	55.8047	-18.20	/	37.17	18.97	40.00	-21.03	peak
3	434.0649	-14.87	/	94.27	79.40	100.82	-21.42	peak
4	434.0650	/	-7.12	/	72.28	80.82	-8.54	AVG
5	869.1300	-8.66	/	51.42	42.76	80.82	-38.06	peak
6	869.1302	/	-7.12	/	35.64	60.82	-25.18	AVG

Remarks:
 1. Factor (dB/m) = Antenna Factor (dB/m)+Cable Factor (dB)-Pre-amplifier Factor
 2. Margin value = Level- Limit value
 3. AVG=Peak+Duty Cycle Factor(-7.12)



Adobe 1GHz

Ant. Pol.	Horizontal
Test Mode:	TX Mode 433.92MHz
Remark:	No report for the emission which more than 10 dB below the prescribed limit.

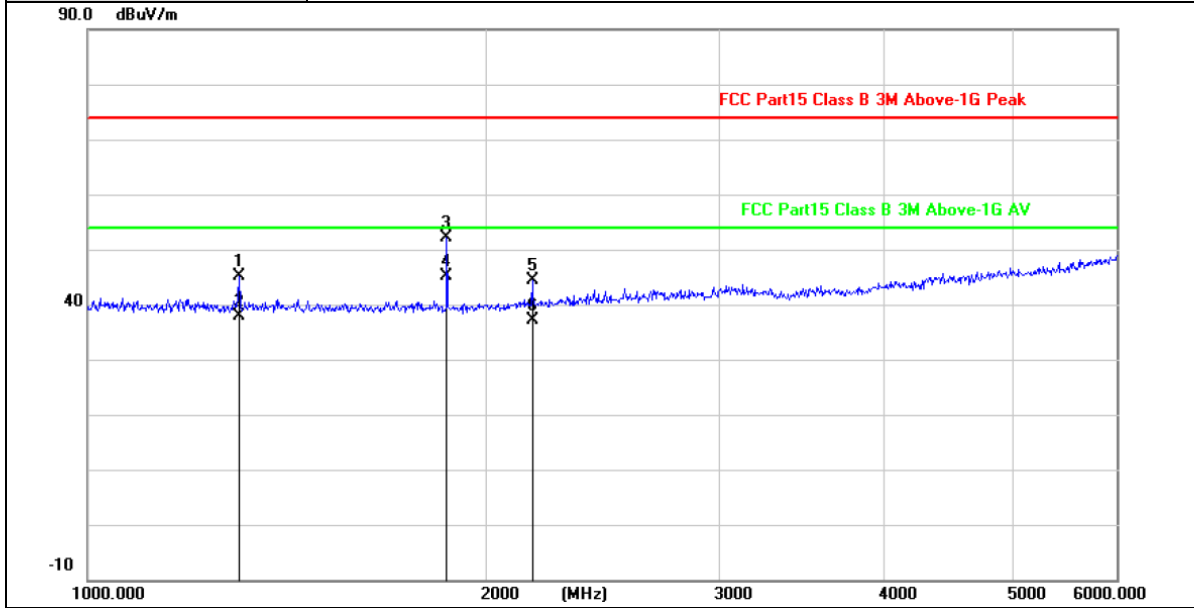

No.	Frequency (MHz)	Factor (dB/m)	Duty Cycle Factor	Reading (dBuV)	Level (dBuV/m)	Limit (dBuV/m)	Margin (dB)	Det.
1	1301.332	-11.66	/	56.68	45.02	74.00	-28.98	peak
2	1301.332	/	-7.12	/	37.90	54.00	-16.10	AVG
3	1868.851	-10.57	/	62.80	52.23	74.00	-21.77	peak
4	1868.851	/	-7.12	/	45.11	54.00	-8.89	AVG
5	2168.510	-9.11	/	53.41	44.30	74.00	-29.70	peak
6	2168.510	/	-7.12	/	37.18	54.00	-16.82	AVG

Remarks:
 1. Factor (dB/m) = Antenna Factor (dB/m)+Cable Factor (dB)-Pre-amplifier Factor
 2. Margin value = Level- Limit value
 3. AVG=Peak+Duty Cycle Factor(-7.12)



Ant. Pol.	Vertical
Test Mode:	TX Mode 433.92MHz
Remark:	No report for the emission which more than 10 dB below the prescribed limit.

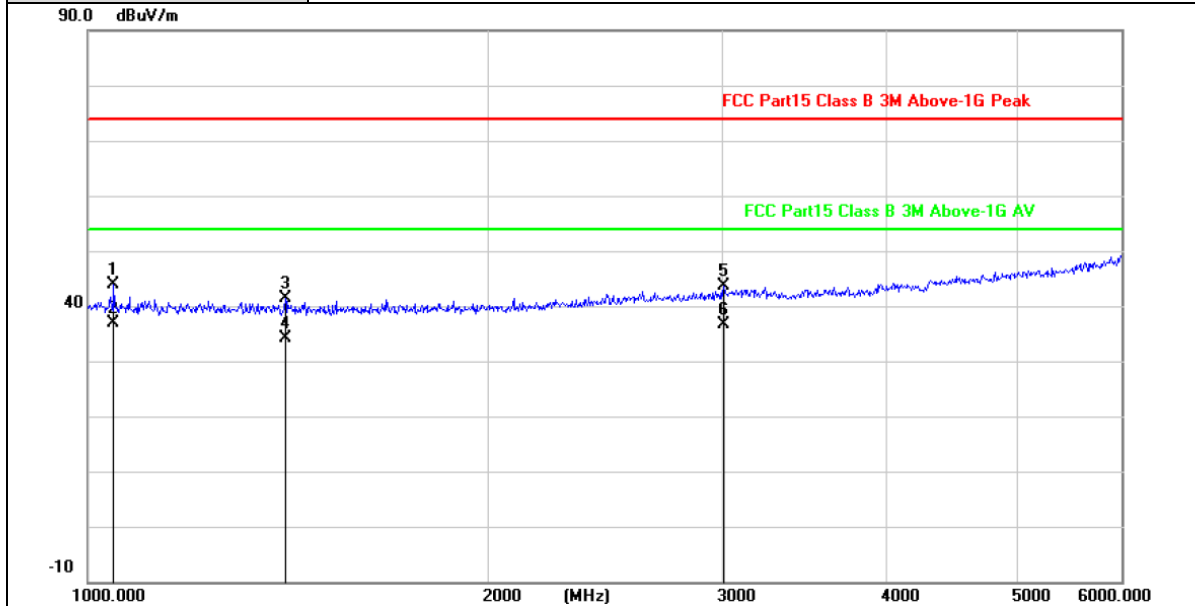

No.	Frequency (MHz)	Factor (dB/m)	Duty Cycle Factor	Reading (dBuV)	Level (dBuV/m)	Limit (dBuV/m)	Margin (dB)	Det.
1	1045.812	-12.37	/	56.32	43.95	74.00	-30.05	peak
2	1045.812	/	-7.12	/	36.83	54.00	-17.17	AVG
3	1408.079	-11.19	/	52.49	41.30	74.00	-32.70	peak
4	1408.079	/	-7.12	/	34.18	54.00	-19.82	AVG
5	3009.976	-6.52	/	50.20	43.68	74.00	-30.32	peak
6	3009.976	/	-7.12	/	36.56	54.00	-17.44	AVG

Remarks:

1. Factor (dB/m) = Antenna Factor (dB/m)+Cable Factor (dB)-Pre-amplifier Factor
2. Margin value = Level- Limit value
3. AVG=Peak+Duty Cycle Factor(-7.12)



3.3. 20dB Bandwidth

Limit

FCC CFR Title 47 Part 15 Subpart C Section 15.231(c):

The bandwidth of the emission shall be no wider than 0.25% of the center frequency for devices operating above 70 MHz and below 900 MHz. For devices operating above 900 MHz, the emission shall be no wider than 0.5% of the center frequency. Bandwidth is determined at the points 20 dB down from the modulated carrier.

$$433.92\text{MHz} \times 0.25\% = 1.085\text{MHz}$$

Test Configuration

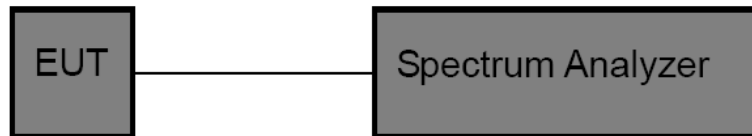

Test Procedure

1. The EUT was directly connected to the spectrum analyzer and antenna output port as show in the block diagram above.
2. Spectrum Setting:
 - (1) Set RBW = 1% ~ 5% OCB.
 - (2) Set the video bandwidth (VBW) ≥ 3 RBW.
 - (3) Detector = Peak.
 - (4) Trace mode = Max hold.
 - (5) Sweep = Auto couple.

Test Mode

Please refer to the clause 2.3.

Test Results



Channel Frequency(MHz)	20dB Bandwidth(kHz)	Limit (MHz)	Result
433.92	11.29	1.085	PASS

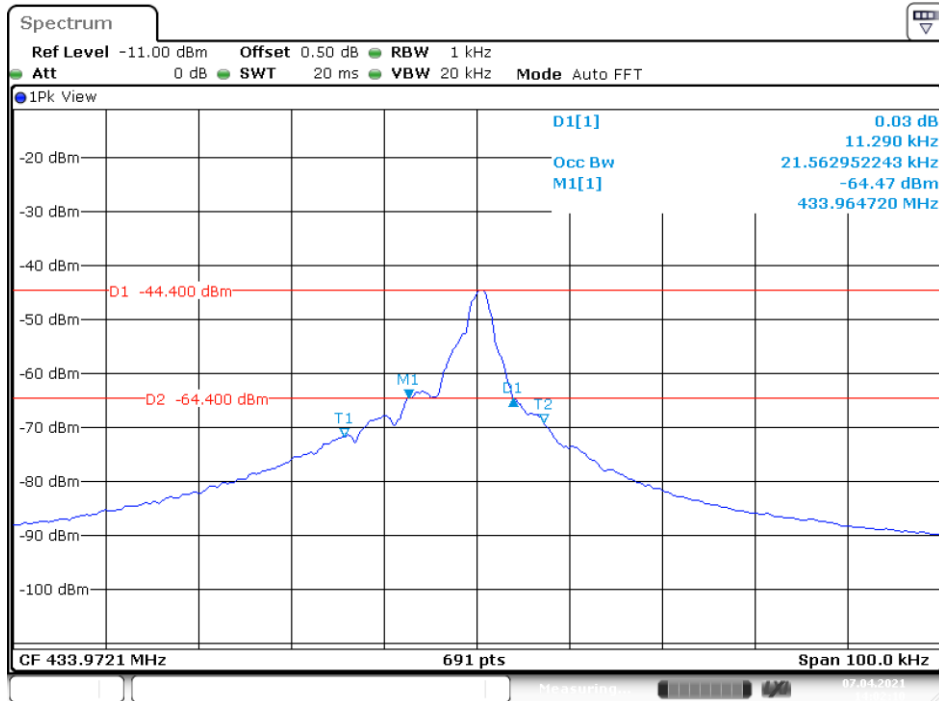

Date: 7.APR.2021 14:02:11

3.4. Continue Transmission Time

Limit

FCC CFR Title 47 Part 15 Subpart C Section 15.231(a).

A manually operated transmitter shall employ a switch that will auto-matically deactivate the transmitter within not more than 5 seconds of being released.

A transmitter activated automatically shall cease transmission within 5 seconds after activation.

Test Configuration

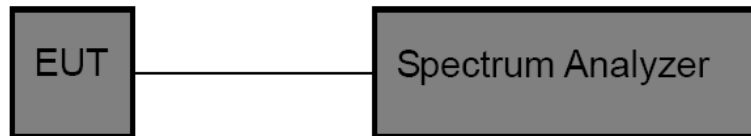

Test Procedure

1. The transmitter output was connected to the spectrum analyzer through an attenuator, the path loss was compensated to the results for each measurement.
2. Set to the maximum power setting and enable the EUT transmit continuously
3. Use the following spectrum analyzer settings:
Frequency=Center carrier frequency
RBW=100KHz, VBW=300KHz, Span= 0,
Sweep time= 10second, Detector function = peak, Trace = single
4. Measure and record the results in the test report.

Test Mode

Please refer to the clause 2.3.

Test Result



Frequency (MHz)	Transmission time (s)	Limit (s)	Result
433.92	0.11594	<5.00	Pass

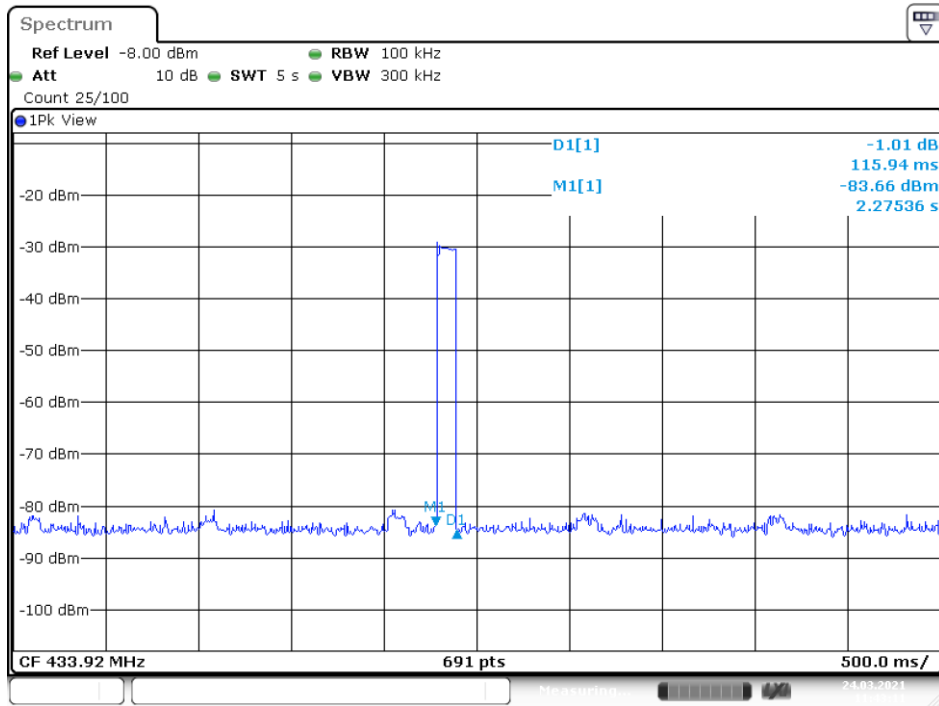

Date: 24.MAR.2021 11:43:11

3.5. Duty Cycle

Limit

The duration of each transmission shall not be more than 1 second and the rest time between transfers shall be at least 30 times the duration of propagation, but in any case less than 10 seconds.

Test Configuration

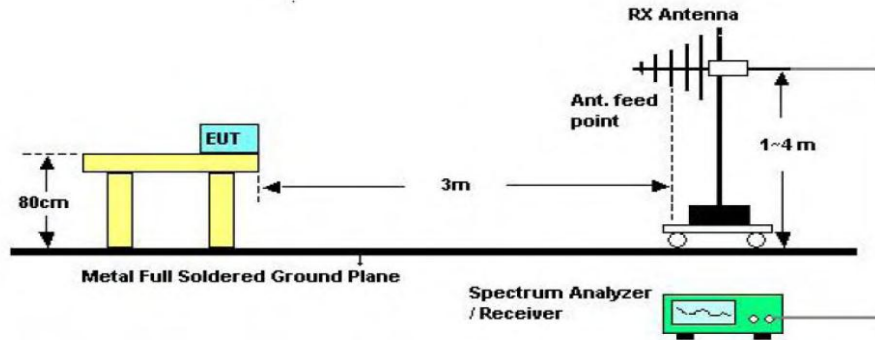

Test Procedure

1. The EUT was setup and tested according to ANSI C63.10:2013 requirements.
2. The EUT is placed on a turn table which is 0.8 meter above ground. The turn table is rotated 360 degrees to determine the position of the maximum emission level.
3. The EUT was positioned such that the distance from antenna to the EUT was 3 meters.
4. The antenna is scanned from 1 meter to 4 meters to find out the maximum emission level. This is repeated for both horizontal and vertical polarization of the antenna. In order to find the maximum emission, all of the interface cables were manipulated according to ANSI C63.10:2013 on radiated measurement.

Test Mode

Please refer to the clause 2.3.

Test Result

Please refer the following pages:

Plot 1: Because the transmit period of the EUT already exceed 100ms, so 100ms was used for calculated, the large pulses total 36, the small pulses total 42.

Plot 2: One large pulse in a time period of 0.78ms.

Plot 3: One small pulse in a time period of 0.38ms.

Duty Cycle=ON/Total=(36*0.78+42*0.38)/100=44.04/100=44.04%

20 log(Duty Cycle)=-7.12



Plot 1

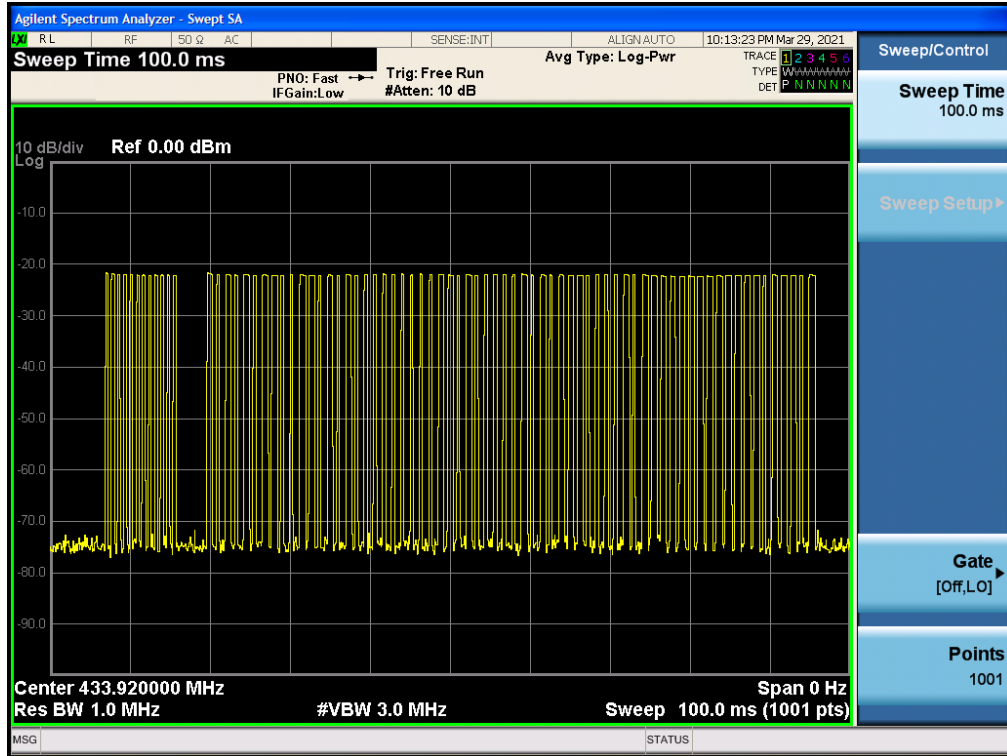

Plot 2

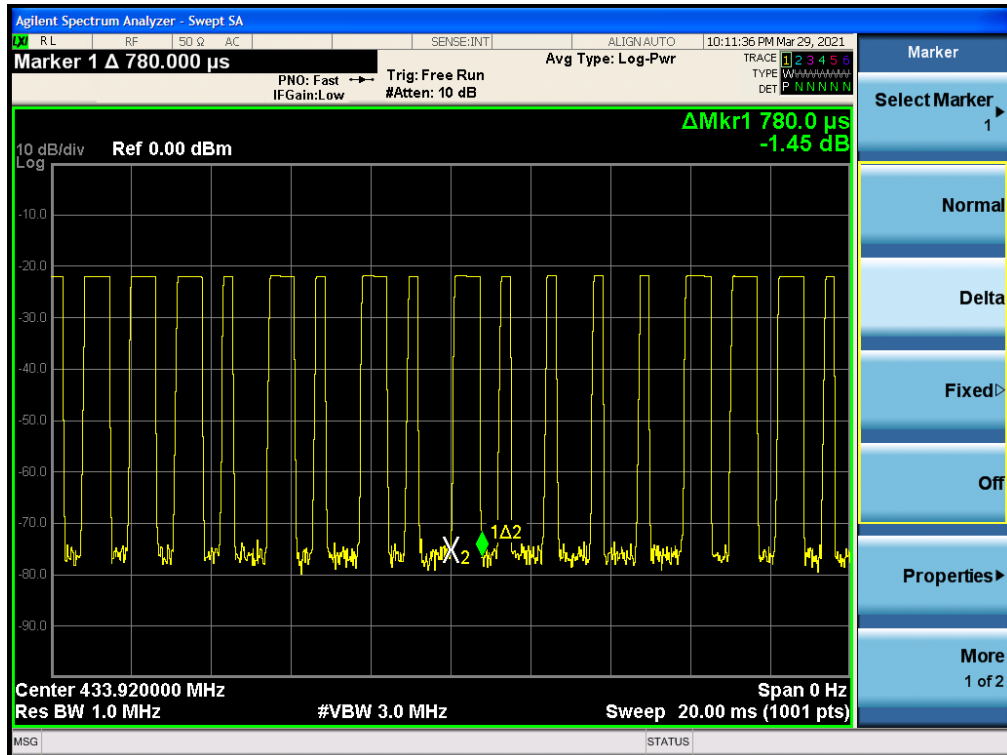



Plot 3

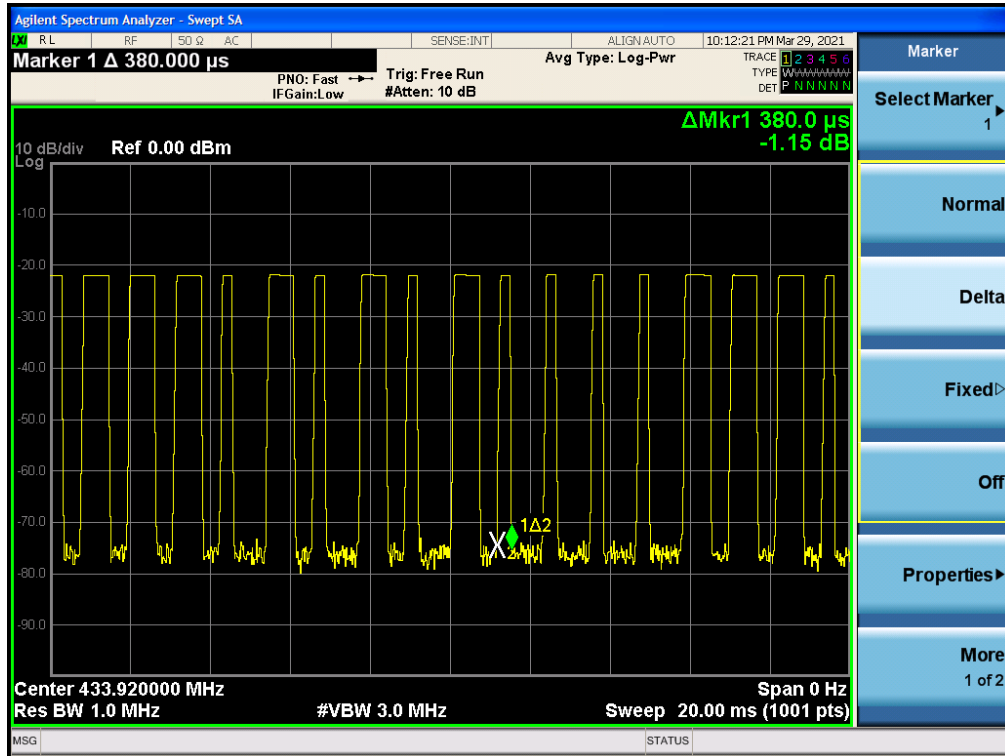



3.6. Antenna Requirement

Requirement

FCC CFR Title 47 Part 15 Subpart C Section 15.203:

An intentional radiator shall be designed to ensure that no antenna other than that furnished by the responsible party shall be used with the device. The use of a permanently attached antenna or of antenna that uses a unique coupling to the intentional radiator, the manufacturer may design the unit so that a broken antenna can be replaced by the user, but the use of a standard antenna jack or electrical connector is prohibited.

FCC CFR Title 47 Part 15 Subpart C Section 15.247(c) (1)(i):

(i) Systems operating in the 2400~2483.5 MHz band that is used exclusively for fixed. Point-to-point operations may employ transmitting antennas with directional gain greater than 6dBi provided the maximum conducted output power of the intentional radiator is reduced by 1 dB for every 3 dB that the directional gain of the antenna exceeds 6dBi.

Test Result

The directional gain of the antenna less than 6dBi, please refer to the EUT internal photographs antenna photo.

*****THE END*****