



# **FCC TEST REPORT**

**FCC ID: 2ARVP-SGT-G14**

On Behalf of

**Shenzhen Guarder Secure Technology Co., Ltd.**

**Smart camera**

**Model No.: SGT-G15, SGT-G16, SGT-G17, SGT-G18,  
SGT-G572G/H, SGT-H565G/H, SGT-G812G/H, SGT-H896G/H,  
SGT-897G/H, SGT-G14**

Prepared for : Shenzhen Guarder Secure Technology Co., Ltd.  
Address : Floor 5B, Building D, Ke Li Bang Industrial Area, Fucheng Subdistrict,  
Longhua, Shenzhen, China

Prepared By : Shenzhen Alpha Product Testing Co., Ltd.  
Address : Building i, No.2, Lixin Road, Fuyong Street, Bao'an District, 518103,  
Shenzhen, Guangdong, China

Report Number : T1881751 05  
Date of Receipt : November 13, 2018  
Date of Test : November 13, 2018-December 18, 2018  
Date of Report : December 18, 2018  
Version Number : REV0

## TABLE OF CONTENTS

Description	Page
<b>1. Summary of Standards And Results-----</b>	<b>6</b>
1.1. Description of Standards and Results -----	6
<b>2. General Information -----</b>	<b>7</b>
2.1. Description of Device (EUT)-----	7
2.2. Accessories of Device (EUT) -----	8
2.3. Tested Supporting System Details -----	8
2.4. Block Diagram of connection between EUT and simulators -----	8
2.5. Test Mode Description -----	9
2.6. Test Conditions -----	10
2.7. Test Facility -----	10
2.8. Measurement Uncertainty -----	11
2.9. Test Equipment List -----	12
<b>3. Spurious Emission -----</b>	<b>13</b>
3.1. Test Limits -----	13
3.2. Test Procedure -----	13
3.3. Test Setup -----	14
3.4. Test Results -----	15
<b>4. Power line Conducted Emission -----</b>	<b>22</b>
4.1. Test Limits -----	22
4.2. Test Procedure -----	22
4.3. Test Setup -----	22
4.4. Test Results -----	23
<b>5. Conducted Maximum Output Power -----</b>	<b>25</b>
5.1. Test limits -----	25
5.2. Test Procedure -----	25
5.3. Test Setup -----	25
5.4. Test Results -----	25
<b>6. Peak Power Spectral Density-----</b>	<b>27</b>
6.1. Test limits -----	27
6.2. Test Procedure -----	27
6.3. Test Setup -----	27
6.4. Test Results -----	28
<b>7. Bandwidth-----</b>	<b>31</b>
7.1. Test limits -----	31
7.2. Test Procedure -----	31
7.3. Test Setup -----	31
7.4. Test Results -----	31
<b>8. Band Edge Check-----</b>	<b>35</b>
8.1. Test limits -----	35
8.2. Test Procedure -----	35
8.3. Test Setup -----	35
8.4. Test Results -----	35

- 9. Antenna Requirement ----- 42**
  - 9.1. Standard Requirement----- 42
  - 9.2. Antenna Connected Construction----- 42
  - 9.3. Results ----- 42
- 10. Test setup photo ----- 43**
  - 10.1. Photos of Radiated emission ----- 43
  - 10.2. Photos of Conducted Emission test----- 44
- 11. EUT photo----- 45**

### TEST REPORT DECLARATION

Applicant : Shenzhen Guarder Secure Technology Co., Ltd.  
 Address : Floor 5B, Building D, Ke Li Bang Industrial Area, Fucheng Subdistrict, Longhua, Shenzhen, China  
 Manufacturer : Shenzhen Guarder Secure Technology Co., Ltd.  
 Address : Floor 5B, Building D, Ke Li Bang Industrial Area, Fucheng Subdistrict, Longhua, Shenzhen, China  
 EUT Description : Smart camera  
 (A) Model No. : SGT-G15, SGT-G16, SGT-G17, SGT-G18, SGT-G572G/H, SGT-H565G/H, SGT-G812G/H, SGT-H896G/H, SGT-897G/H, SGT-G14  
 (B) Trademark : 

Measurement Standard Used:

**FCC Rules and Regulations Part 15 Subpart C Section 15.247: 2017, ANSI C63.10:2013**

The device described above is tested by Shenzhen Alpha Product Testing Co., Ltd. to determine the maximum emission levels emanating from the device. The maximum emission levels are compared to the FCC Part 15 Subpart C limits both conducted and radiated emissions. The test results are contained in this test report and Shenzhen Alpha Product Testing Co., Ltd. is assumed of full responsibility for the accuracy and completeness of these tests.

After the test, our opinion is that EUT compliance with the requirement of the above standards.

This report applies to above tested sample only. This report shall not be reproduced in parts without written approval of Shenzhen Alpha Product Testing Co., Ltd.

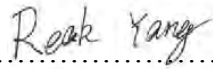
Tested by (name + signature).....: Reak Yang   
 Project Engineer

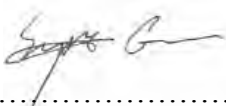
Approved by (name + signature).....: Simple Guan   
 Project Manager

Date of issue..... : December 18, 2018

**Revision History**

Revision	Issue Date	Revisions	Revised By
00	December 18, 2018	Initial released Issue	Simple Guan

## 1. SUMMARY OF STANDARDS AND RESULTS

### 1.1. Description of Standards and Results

The EUT have been tested according to the applicable standards as referenced below:

<b>Test Item</b>	<b>Test Requirement</b>	<b>Standards Paragraph</b>	<b>Result</b>
Conducted Emission	FCC PART 15:2017	15.207	P
6dB Bandwidth	FCC PART 15:2017	15.247 (a)(2)	P
Output Power	FCC PART 15:2017	15.247 (b)(3)	P
Radiated Spurious Emission	FCC PART 15:2017	15.247 (c)	P
Conducted Spurious & Band Edge Emission	FCC PART 15:2017	15.247 (d)	P
Power Spectral Density	FCC PART 15:2017	15.247 (e)	P
Radiated Band Edge Emission	FCC PART 15:2017	15.205	P
Antenna Requirement	FCC PART 15:2017	15.203	P
Note:	1. P is an abbreviation for Pass. 2. F is an abbreviation for Fail. 3. N/A is an abbreviation for Not Applicable.		

## 2. GENERAL INFORMATION

### 2.1. Description of Device (EUT)

Description	: Smart camera
Model Number	: SGT-G15, SGT-G16, SGT-G17, SGT-G18, SGT-G572G/H, SGT-H565G/H, SGT-G812G/H, SGT-H896G/H, SGT-897G/H, SGT-G14
Diff	: There is no difference between all the models, except the model number, this report performs the model SGT-G14.
Trademark	: 
Test Voltage	: Input: 5V $\overline{\text{---}}$ 1A
Operation frequency	: 2412MHz-2462MHz for IEEE 802.11 b, g,n/HT20, 2422MHz~2452MHz for IEEE802.11n/HT40
Channel No.	: 802.11b/802.11g /802.11n(HT20): 11 802.11(HT40): 7
Modulation type	: IEEE 802.11b: DSSS(CCK,DQPSK,DBPSK) IEEE 802.11g: OFDM(64QAM, 16QAM, QPSK, BPSK) IEEE 802.11n :OFDM(64QAM, 16QAM, QPSK, BPSK)
Antenna Type	: PCB Antenna , Maximum Gain is 0dBi
Software version	: V1
Hardware version	: 9632-ZB.V1.5-20180316

## 2.2. Accessories of Device (EUT)

Accessories1	:	TRAVEL CHARGER
Manufacturer	:	SHENZHEN TIANYIN ELECTRONICS CO., LTD.
Model	:	TPA-46050100VU
Power supply	:	Input: 100-240Vac, 50/60Hz, 0.15A; Output: 5V $\overline{\text{---}}$ 1A
Accessories2	:	TRAVEL CHARGER
Manufacturer	:	SHENZHEN TIANYIN ELECTRONICS CO., LTD.
Model	:	TPA-46B050100UU
Power supply	:	Input: 100-240Vac, 50/60Hz, 0.2A; Output: 5V $\overline{\text{---}}$ 1A
Accessories3	:	USB Cable
Manufacturer	:	SHENZHEN TIANYIN ELECTRONICS CO., LTD.
Specification	:	1.2m

## 2.3. Tested Supporting System Details

No.	Description	Manufacturer	Model	Serial Number	Certification or DOC
--	--	--	--	--	--

## 2.4. Block Diagram of connection between EUT and simulators

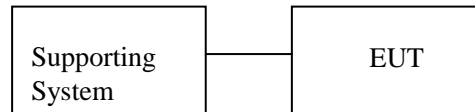



## 2.5. Test Mode Description

Duty cycle :100% Keeping TX			
Mode	data rate (Mbps)(see Note)	Channel	Frequency (MHz)
IEEE 802.11b	1	Low :CH1	2412
	1	Middle: CH6	2437
	1	High: CH11	2462
IEEE 802.11g	6	Low :CH1	2412
	6	Middle: CH6	2437
	6	High: CH11	2462
IEEE 802.11 n/HT20 with 2.4G	6.5	Low :CH1	2412
	6.5	Middle: CH6	2437
	6.5	High: CH11	2462
IEEE 802.11 n/HT40 with 2.4G	13	Low :CH3	2422
	13	Middle: CH6	2437
	13	High: CH9	2452

Note: According exploratory test, EUT will have maximum output power in those data rate. so those data rate were used for all test.

Channel list:					
For IEEE 802.11b, g, n/HT20 and IEEE 802.11 n/HT40 with 2.4G					
Channel	Frequency (MHz)	Channel	Frequency (MHz)	Channel	Frequency (MHz)
CH1	2412	CH5	2432	CH9	2452
CH2	2417	CH6	2437	CH10	2457
CH3	2422	CH7	2442	CH11	2462
CH4	2427	CH8	2447		

Setting output power (Max)			
802.11b	802.11g	802.11n(HT20)	802.11n(HT40)
8.5dBm	8.5dBm	8.5dBm	8.0dBm

## 2.6. Test Conditions

Items	Required	Actual
Temperature range:	15-35°C	27°C
Humidity range:	25-75%	56%
Pressure range:	86-106kPa	980kPa

## 2.7. Test Facility

Shenzhen Alpha Product Testing Co., Ltd  
Building i, No.2, Lixin Road, Fuyong Street, Bao'an District, 518103,  
Shenzhen, Guangdong, China

June 21, 2018 File on Federal Communication Commission  
Registration Number: 293961

July 25, 2017 Certificated by IC  
Registration Number: 12135A

## 2.8.Measurement Uncertainty

(95% confidence levels, k=2)

Item	Uncertainty
Uncertainty for Power point Conducted Emissions Test	2.74dB
Uncertainty for Radiation Emission test in 3m chamber (below 30MHz)	2.13 dB(Polarize: V)
	2.57dB(Polarize: H)
Uncertainty for Radiation Emission test in 3m chamber (30MHz to 1GHz)	3.77dB(Polarize: V)
	3.80dB(Polarize: H)
Uncertainty for Radiation Emission test in 3m chamber (1GHz to 25GHz)	4.16dB(Polarize: H)
	4.13dB(Polarize: V)
Uncertainty for radio frequency	$5.4 \times 10^{-8}$
Uncertainty for conducted RF Power	0.37dB
Uncertainty for temperature	0.2°C
Uncertainty for humidity	1%
Uncertainty for DC and low frequency voltages	0.06%

## 2.9. Test Equipment List

Equipment	Manufacture	Model No.	Serial No.	Last cal.	Cal Interval
3m Semi-Anechoic	ETS-LINDGREN	N/A	SEL0017	2018.09.22	1 Year
Spectrum analyzer	Agilent	E4407B	MY46185649	2018.09.22	1 Year
Receiver	R&S	ESCI	1166.5950K03-1011	2018.09.22	1 Year
Receiver	R&S	ESCI	101202	2018.09.22	1 Year
Bilog Antenna	Schwarzbeck	VULB 9168	VULB9168-438	2018.09.30	2 Year
Horn Antenna	EMCO	3115	640201028-06	2018.09.30	2 Year
Active Loop Antenna	Beijing Daze	ZN30900A	SEL0097	2018.09.30	2 Year
Cable	Resenberger	N/A	No.1	2018.09.22	1 Year
Cable	SCHWARZBECK	N/A	No.2	2018.09.22	1 Year
Cable	SCHWARZBECK	N/A	No.3	2018.09.22	1 Year
Pre-amplifier	Schwarzbeck	BBV9743	9743-019	2018.09.22	1 Year
Pre-amplifier	R&S	AFS33-18002650-30-8P-44	SEL0080	2018.09.22	1 Year
Temperature controller	Terchy	MHQ	120	2018.09.22	1 Year
L.I.S.N.#1	Schwarzbeck	NSLK8126	8126466	2018.09.22	1 Year
L.I.S.N.#2	ROHDE&SCHWARZ	ENV216	101043	2018.09.22	1 Year
20db Attenuator	ICPROBING	IATS1	82347	2018.09.22	1 Year
18-40 Horn Antenna	18-40G antenna	Sas-574	571	2018.3.15	3 Year
Power Meter	Anritsu	ML2487A	6K00001491	2018.09.22	1 Year

### 3. SPURIOUS EMISSION

#### 3.1. Test Limits

Frequencies (MHz)	Field Strength (micorvolts/meter)	Measurement Distance (meters)
0.009~0.490	2400/F(KHz)	300
0.490~1.705	24000/F(KHz)	30
1.705~30.0	30	30
30~88	100	3
88~216	150	3
216~960	200	3
Above 960	500	3

Harmonic emissions limits comply with below 54 dBuV/m at 3m. Other emissions radiated outside of the specified frequency bands, except for harmonics, shall be attenuated by at least 50 dB below the level of the fundamental or comply with the radiated emissions limits specified in section 15.209(a) limit in the table below has to be followed.

**NOTE:**

- a) The tighter limit applies at the band edges.
- b) Emission Level(dB uV/m)=20log Emission Level(Uv/m)

#### 3.2. Test Procedure

The measuring distance of 3m shall be used for measurements at frequency up to 1GHz and above 1GHz, The EUT was placed on a rotating 0.8 m high above ground, The table was rotated 360 degrees to determine the position of the highest radiation

The Test antenna shall vary between 1m and 4m,Both Horizontal and Vertical antenna are set of make measurement.

The initial step in collecting conducted emission data is a spectrum analyzer Peak detector mode pre-scanning the measurement frequency range. Significant Peaks are then marked. and then Qusia Peak Detector mode premeasured

If Peak value comply with QP limit Below 1GHz.The EUT deemed to comply with QP limit. But the Peak value and average value both need to comply with applicable limit above 1GHz.

For the actual test configuration, please see the test setup photo.

### 3.3. Test Setup

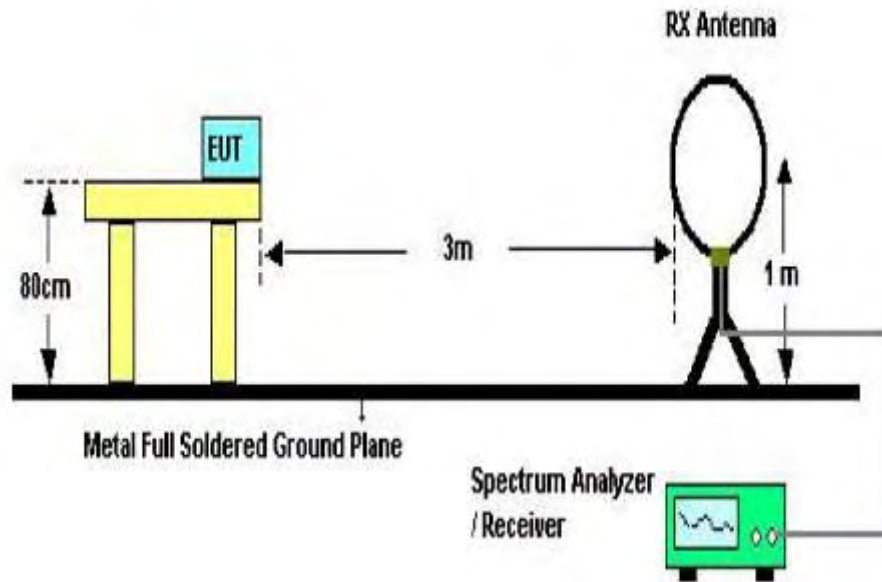

Below 30MHz Test Setup

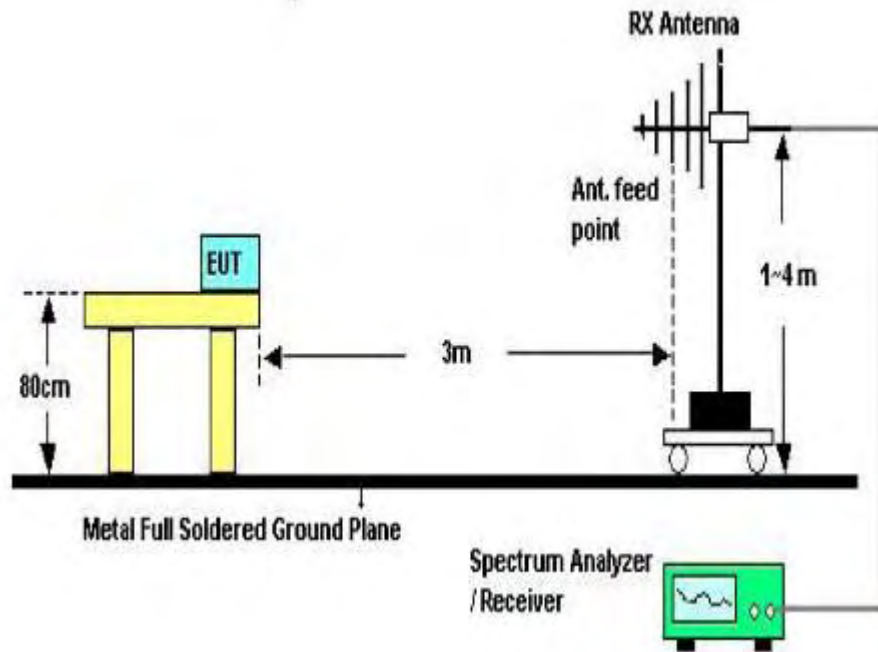

Above 30MHz Test Setup

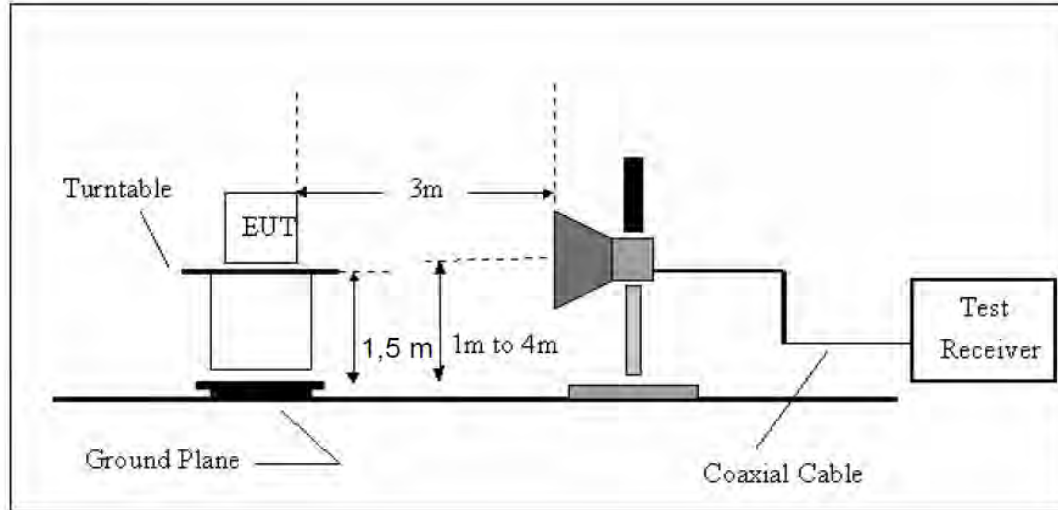

Above 1GHz Test Setup

### 3.4. Test Results

#### Test Condition

Continual Transmitting in maximum power.

9KHz~150KHz	RBW200Hz	VBW1KHz
150KHz~30MHz	RBW9KHz	VBW 30KHz
30MHz~1GHz	RBW120KHz	VBW 300KHz
Above1GHz	RBW1MHz	VBW 3MHz

We have scanned the 10th harmonic from 9 kHz to the EUT.

Detailed information please see the following page.

From 9KHz to 30MHz: Conclusion: PASS

Note:1.The amplitude of spurious emissions which are attenuated by more than 20dB below the permissible value has no need to be reported.

2.Only show the test data of the worst Channel in this report.

Test result for IEEE 802.11 n/HT20 (Low Channel), AC 120V/ 60Hz  
Vertical

Radiated Emission Measurement

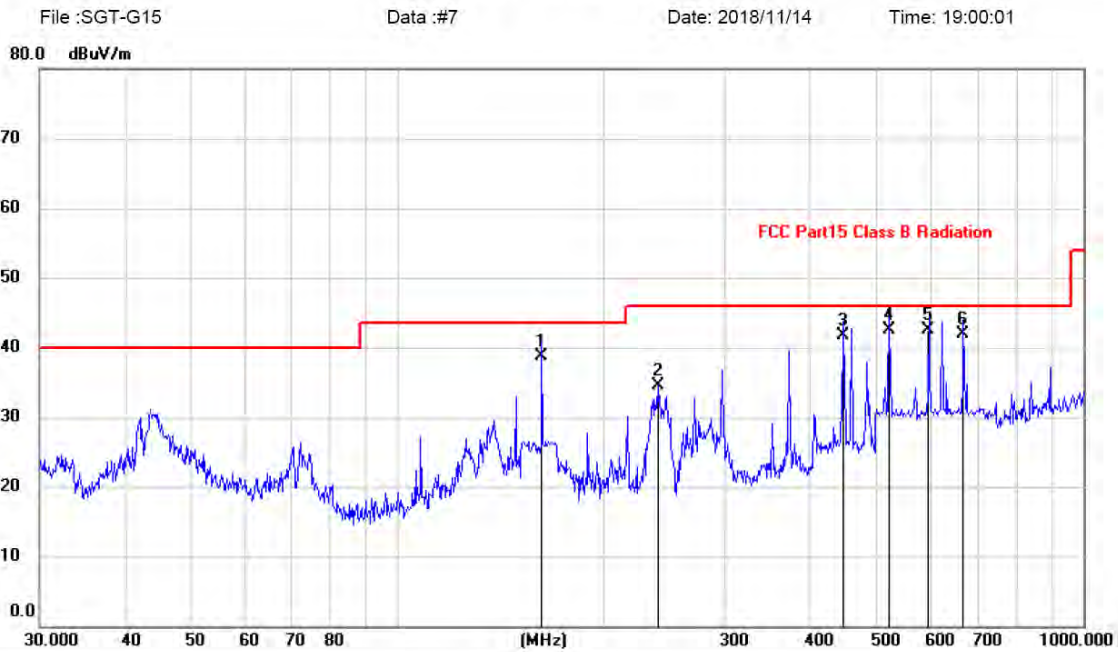

No.	Mk.	Freq.	Reading Level	Correct Factor	Measurement	Limit	Margin	Antenna Height	Table Degree	
		MHz	dBuV	dB	dBuV/m	dBuV/m	dB	cm	degree	Comment
1		162.6105	24.34	14.37	38.71	43.50	-4.79			QP
2		239.9873	22.54	11.98	34.52	46.00	-11.48			peak
3		446.4141	24.89	16.86	41.75	46.00	-4.25			QP
4	*	520.8881	24.65	17.92	42.57	46.00	-3.43			QP
5		595.1326	23.29	19.17	42.46	46.00	-3.54			QP
6		670.4891	21.35	20.50	41.85	46.00	-4.15			QP

Note:1. \*:Maximum data; x:Over limit; !:over margin.

2.Measurement=Reading Level+Correct Factor; Correct Factor=Antenna Factor+Cable Loss.



# Horizontal

## Radiated Emission Measurement

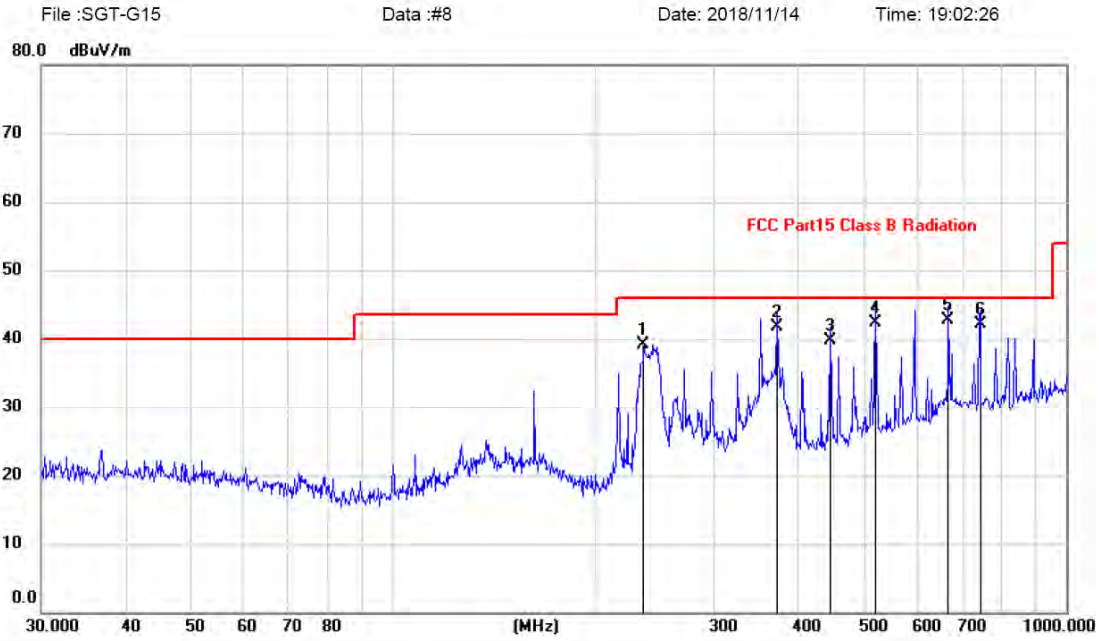

No.	Mk.	Freq.	Reading Level	Correct Factor	Measurement	Limit	Margin	Antenna Height	Table Degree	
		MHz	dBuV	dB	dBuV/m	dBuV/m	dB	cm	degree	Comment
1		235.8163	27.22	11.90	39.12	46.00	-6.88			peak
2		372.0045	26.55	15.23	41.78	46.00	-4.22			QP
3		446.4141	22.94	16.86	39.80	46.00	-6.20			QP
4		520.8882	24.35	17.92	42.27	46.00	-3.73			QP
5	*	670.4892	22.10	20.51	42.61	46.00	-3.39			QP
6		747.4825	20.77	21.27	42.04	46.00	-3.96			QP

Note: 1. \*:Maximum data; x:Over limit; !:over margin.

2.Measurement=Reading Level+Correct Factor; Correct Factor=Antenna Factor+Cable Loss.

From 1G-25GHz

Test Mode: IEEE 802.11b TX Low									
Freq (MHz)	Read Level (dBuV/m)	Polar (H/V)	Antenna Factor (dB/m)	Cable loss(dB)	Amp Factor (dB)	Result (dBuV/m)	Limit (dBuV/m)	Margin (dB)	Remark
4824	45.20	V	33.95	10.18	34.26	55.07	74	18.93	PK
4824	34.78	V	33.95	10.18	34.26	44.65	54	9.35	AV
7236	/								
9648	/								
4824	43.16	H	33.95	10.18	34.26	53.03	74	20.97	PK
4824	33.36	H	33.95	10.18	34.26	43.23	54	10.77	AV
7236									
9648									
Test Mode: IEEE 802.11b TX Mid									
4874	42.69	V	33.93	10.2	34.29	52.53	74	21.47	PK
4874	33.75	V	33.93	10.2	34.29	43.59	54	10.41	AV
7311	/								
9748	/								
4874	42.68	H	33.93	10.2	34.29	52.52	74	21.48	PK
4874	33.53	H	33.93	10.2	34.29	43.37	54	10.63	AV
7311									
9748									
Test Mode: IEEE 802.11b TX High									
4924	42.36	V	33.98	10.22	34.25	52.31	74	21.69	PK
4924	33.67	V	33.98	10.22	34.25	43.62	54	10.38	AV
7386	/								
9848	/								
4924	43.55	H	33.98	10.22	34.25	53.50	74	20.50	PK
4924	32.70	H	33.98	10.22	34.25	42.65	54	11.35	AV
7386									
9848									
Note:									
1, Result = Read level + Antenna factor + cable loss-Amp factor									
2, All the other emissions not reported were too low to read and deemed to comply with FCC limit.									

Test Mode: IEEE 802.11g TX Low									
Freq (MHz)	Read Level (dBuV/m)	Polar (H/V)	Antenna Factor (dB/m)	Cable loss(dB)	Amp Factor (dB)	Result (dBuV/m)	Limit (dBuV/m)	Margin (dB)	Remark
4824	44.70	V	33.95	10.18	34.26	54.57	74	19.43	PK
4824	32.07	V	33.95	10.18	34.26	41.94	54	12.06	AV
7236	/								
9648	/								
4824	44.14	H	33.95	10.18	34.26	54.01	74	19.99	PK
4824	35.63	H	33.95	10.18	34.26	45.50	54	8.50	AV
7236									
9648									
Test Mode: IEEE 802.11g TX Mid									
4874	42.63	V	33.93	10.2	34.29	52.47	74	21.53	PK
4874	35.47	V	33.93	10.2	34.29	45.31	54	8.69	AV
7311	/								
9748	/								
4874	42.60	H	33.93	10.2	34.29	52.44	74	21.56	PK
4874	33.54	H	33.93	10.2	34.29	43.38	54	10.62	AV
7311									
9748									
Test Mode: IEEE 802.11g TX High									
4924	43.84	V	33.98	10.22	34.25	53.79	74	20.21	PK
4924	35.41	V	33.98	10.22	34.25	45.36	54	8.64	AV
7386	/								
9848	/								
4924	43.98	H	33.98	10.22	34.25	53.93	74	20.07	PK
4924	34.45	H	33.98	10.22	34.25	44.40	54	9.60	AV
7386									
9848									
Note:									
1, Result = Read level + Antenna factor + cable loss-Amp factor									
2, All the other emissions not reported were too low to read and deemed to comply with FCC limit.									

Test Mode:IEEE 802.11n HT20 TX Low									
Freq (MHz)	Read Level (dBuV/m)	Polar (H/V)	Antenna Factor (dB/m)	Cable loss(dB)	Amp Factor (dB)	Result (dBuV/m)	Limit (dBuV/m)	Margin (dB)	Remark
4824	46.40	V	33.95	10.18	34.26	56.27	74	17.73	PK
4824	33.02	V	33.95	10.18	34.26	42.89	54	11.11	AV
7236	/								
9648	/								
4824	44.73	H	33.95	10.18	34.26	54.60	74	19.40	PK
4824	34.26	H	33.95	10.18	34.26	44.13	54	9.87	AV
7236									
9648									
Test Mode:IEEE 802.11n HT20 TX Mid									
4874	41.40	V	33.93	10.2	34.29	51.24	74	22.76	PK
4874	32.37	V	33.93	10.2	34.29	42.21	54	11.79	AV
7311	/								
9748	/								
4874	42.62	H	33.93	10.2	34.29	52.46	74	21.54	PK
4874	33.65	H	33.93	10.2	34.29	43.49	54	10.51	AV
7311									
9748									
Test Mode:IEEE 802.11n HT20 TX High									
4924	42.56	V	33.98	10.22	34.25	52.51	74	21.49	PK
4924	32.95	V	33.98	10.22	34.25	42.90	54	11.10	AV
7386	/								
9848	/								
4924	42.48	H	33.98	10.22	34.25	52.43	74	21.57	PK
4924	33.82	H	33.98	10.22	34.25	43.77	54	10.23	AV
7386									
9848									
Note:									
1, Result = Read level + Antenna factor + cable loss-Amp factor									
2, All the other emissions not reported were too low to read and deemed to comply with FCC limit.									

Test Mode:IEEE 802.11n HT40 TX Low									
Freq (MHz)	Read Level (dBuV/m)	Polar (H/V)	Antenna Factor (dB/m)	Cable loss(dB)	Amp Factor (dB)	Result (dBuV/m)	Limit (dBuV/m)	Margin (dB)	Remark
4844	43.09	V	33.95	10.18	34.26	52.96	74	21.04	PK
4844	33.78	V	33.95	10.18	34.26	43.65	54	10.35	AV
7266	/								
9688	/								
4844	45.03	H	33.95	10.18	34.26	54.90	74	19.10	PK
4844	33.71	H	33.95	10.18	34.26	43.58	54	10.42	AV
7266									
9688									
Test Mode:IEEE 802.11n HT40 TX Mid									
4874	43.14	V	33.93	10.2	34.29	52.98	74	21.02	PK
4874	32.38	V	33.93	10.2	34.29	42.22	54	11.78	AV
7311	/								
9748	/								
4874	42.12	H	33.93	10.2	34.29	51.96	74	22.04	PK
4874	32.25	H	33.93	10.2	34.29	42.09	54	11.91	AV
7311									
9748									
Test Mode:IEEE 802.11n HT40 TX High									
4904	41.77	V	33.98	10.22	34.25	51.72	74	22.28	PK
4904	33.85	V	33.98	10.22	34.25	43.80	54	10.20	AV
7356	/								
9808	/								
4904	41.99	H	33.98	10.22	34.25	51.94	74	22.06	PK
4904	34.44	H	33.98	10.22	34.25	44.39	54	9.61	AV
7356									
9808									
Note:									
1, Result = Read level + Antenna factor + cable loss-Amp factor									
2, All the other emissions not reported were too low to read and deemed to comply with FCC limit.									

## 4. POWER LINE CONDUCTED EMISSION

### 4.1. Test Limits

Frequency MHz	Limits dB( $\mu$ V)	
	Quasi-peak Level	Average Level
0.15 -0.50	66 -56*	56 - 46*
0.50 -5.00	56	46
5.00 -30.00	60	50

- Notes: 1. \*Decreasing linearly with logarithm of frequency.  
 2. The lower limit shall apply at the transition frequencies.  
 3. The limit decreases in line with the logarithm of the frequency in the rang of 0.15 to 0.50 MHz.

### 4.2. Test Procedure

The EUT is put on the plane 0.8m high above the ground by insulating support and is connected to the power mains through a line impedance stabilization network (L.I.S.N.). This provides a 50ohm coupling impedance for the EUT system. Please refer the block diagram of the test setup and photographs. Both sides of AC lines are checked to find out the maximum conducted emission. In order to find the maximum emission levels, the relative positions of equipment and all of the interface cables shall be changed according to ANSI C63.10:2013 on Conducted Emission Measurement.

The bandwidth of test receiver is set at 9 kHz.

### 4.3. Test Setup

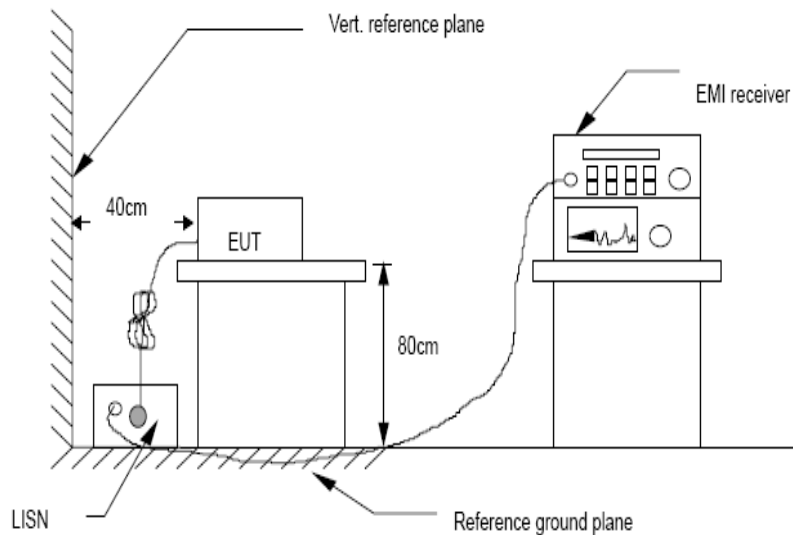

### 4.4. Test Results

Test result for IEEE 802.11 n/HT20 (Low Channel), AC 120V/ 60Hz

Line:

#### Conducted Emission Measurement

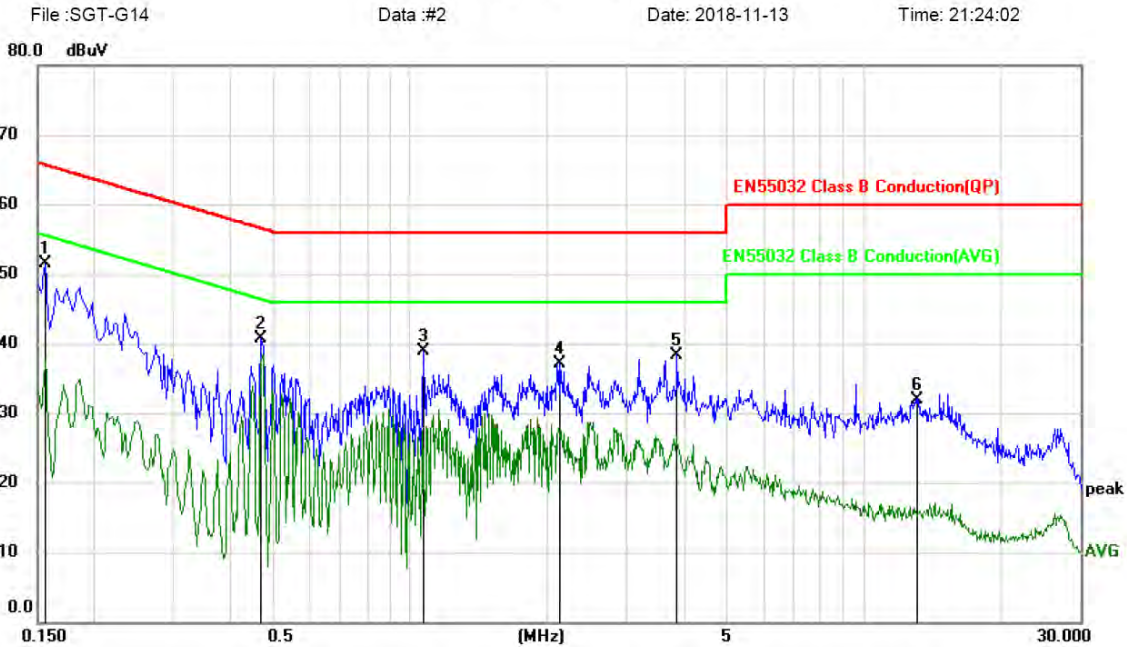

No.	Mk.	Freq. MHz	Reading Level dBuV	Correct Factor dB	Measure- ment dBuV	Limit dBuV	Margin dB	Detector	Comment
1	*	0.1560	41.77	9.66	51.43	65.67	-14.24	peak	
2		0.4680	31.03	9.71	40.74	56.55	-15.81	peak	
3		1.0680	29.20	9.78	38.98	56.00	-17.02	peak	
4		2.1420	27.15	9.89	37.04	56.00	-18.96	peak	
5		3.8670	28.33	10.07	38.40	56.00	-17.60	peak	
6		13.0649	21.65	10.35	32.00	60.00	-28.00	peak	

\*:Maximum data    x:Over limit    !:over margin

Note: Measurement=Reading Level+Correc Factor.    Factor=(LISN or ISN or PLC or Current Probe)Factor+Cable

Neutral:

**Conducted Emission Measurement**

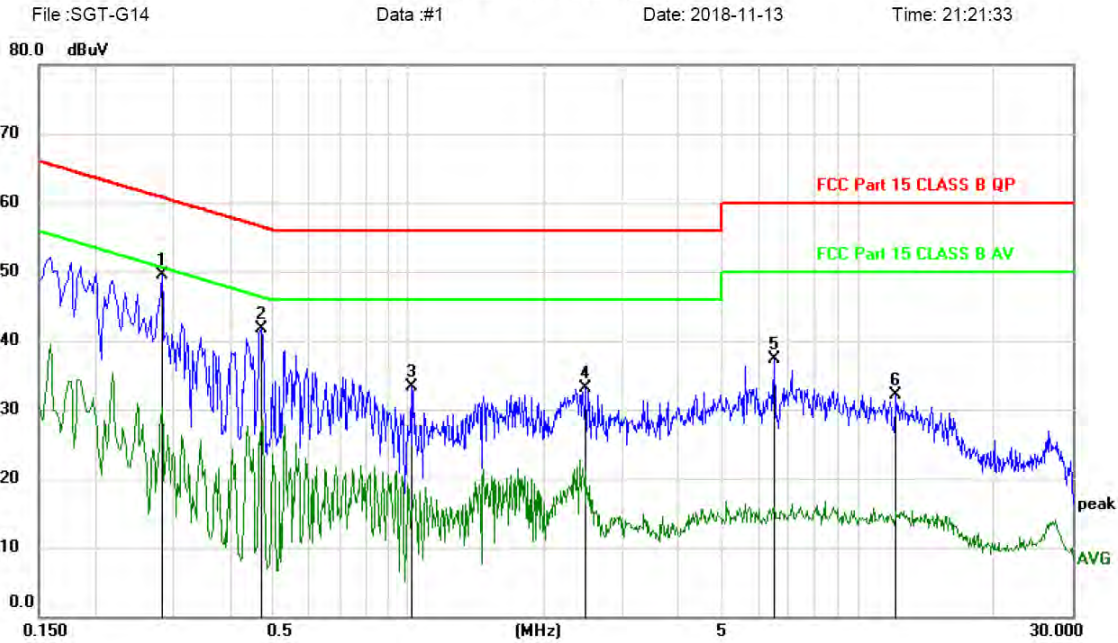

No.	Mk.	Freq. MHz	Reading Level dBuV	Correct Factor dB	Measure- ment dBuV	Limit dBuV	Margin dB	Detector	Comment
1	*	0.2819	39.83	9.69	49.52	60.76	-11.24	peak	
2		0.4710	31.92	9.71	41.63	56.50	-14.87	peak	
3		1.0140	23.57	9.77	33.34	56.00	-22.66	peak	
4		2.4750	23.12	9.93	33.05	56.00	-22.95	peak	
5		6.5100	27.14	10.24	37.38	60.00	-22.62	peak	
6		12.1440	21.74	10.38	32.12	60.00	-27.88	peak	

\*:Maximum data    x:Over limit    !:over margin

Note: Measurement=Reading Level+Correc Factor.    Factor=(LISN or ISN or PLC or Current Probe)Factor+Cable



## 5. CONDUCTED MAXIMUM OUTPUT POWER

### 5.1. Test limits

Please refer section 15.247.

Regulation 15.247(b) The limit of Maximum Peak Output Power Measurement is 1 W(30dBm)

### 5.2. Test Procedure

Details see the KDB558074 D01 Meas Guidance V04

5.2.1 Place the EUT on the table and set it in transmitting mode.

5.2.2 Connected the EUT's antenna port to peak power meter by 20dB attenuator.

5.2.3 Measure out each mode and each bands peak output power of EUT.

Note: The cable loss and attenuator loss were offset into measure device as amplitude offset.

### 5.3. Test Setup

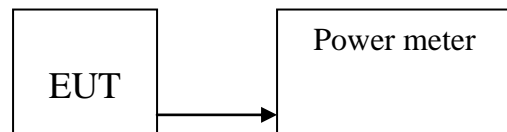

### 5.4. Test Results

PASS

Detailed information please see the following page.

Mode	Frequency (MHz)	PK Output power(dBm)	Limit (dBm)	Result
IEEE 802.11 b	CH1: 2412	8.31	30	PASS
	CH6: 2437	8.27	30	PASS
	CH11: 2462	8.13	30	PASS
IEEE 802.11 g	CH1: 2412	8.10	30	PASS
	CH6: 2437	7.10	30	PASS
	CH11: 2462	7.18	30	PASS
IEEE 802.11 n/HT20 with 2.4G	CH1: 2412	<b>8.40</b>	30	PASS
	CH6: 2437	7.45	30	PASS
	CH11: 2462	6.95	30	PASS
IEEE 802.11 n/HT40 with 2.4G	CH3: 2422	7.75	30	PASS
	CH6: 2437	7.64	30	PASS
	CH9: 2452	7.77	30	PASS

## 6. PEAK POWER SPECTRAL DENSITY

### 6.1. Test limits

6.1.1 Please refer section 15.247.

6.1.2 For direct sequence systems, the peak power spectral density conducted from the intentional radiator to the antenna shall not be greater than 8dBm in any 3kHz band during any time interval of continuous transmission.

6.1.3 The direct sequence operating of the hybrid system, with the frequency hopping operation turned off, shall comply with the power density requirements of paragraph (d) of this section.

### 6.2. Test Procedure

Details see the KDB558074 D01 Meas Guidance V04

6.2.1 Place the EUT on the table and set it in transmitting mode.

6.2.2 Remove the antenna from the EUT and then connect a low loss RF cable from the antenna port to the spectrum analyzer.

6.2.3 Set the spectrum analyzer as  $RBW = 3\text{kHz}$  (Set the RBW to:  $3\text{ kHz} \leq RBW \leq 100\text{ kHz}$ ),  $VBW = 10\text{kHz}$  (Set the  $VBW \geq 3 \times RBW$ ),  $\text{span} = 1.5 \times \text{DTS bandwidth}$ ., detail see the test plot.

6.2.4 Record the max reading.

6.2.5 Repeat the above procedure until the measurements for all frequencies are completed.

### 6.3. Test Setup

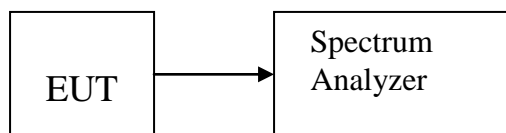

## 6.4. Test Results

Test CH	Power Spectral Density (dBm)				Limit (dBm/3kHz)	Result
	802.11b	802.11g	802.11n(HT20)	802.11n(HT40)		
Lowest	-23.365	-24.939	-22.622	-24.032	8.00	Pass
Middle	-22.851	-25.622	-26.345	-25.531		
Highest	-23.830	-26.134	-25.930	-26.246		

802.11b 802.11g



Lowest channel



Middle channel

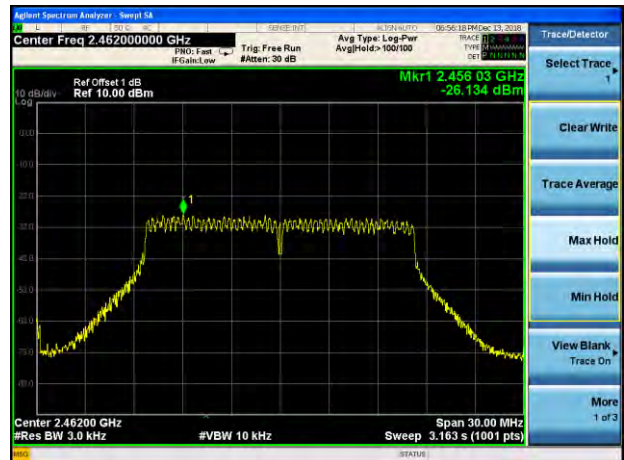

Highest channel

802.11n(HT20) 802.11n(HT40)

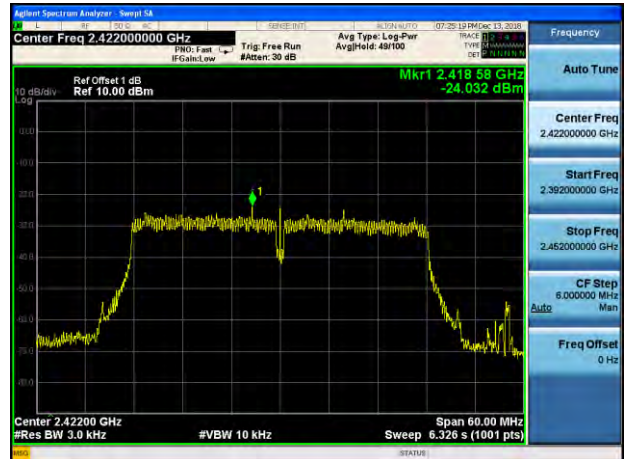
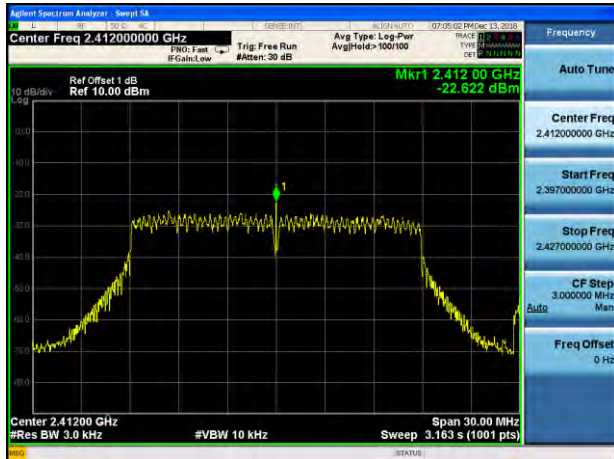

Lowest channel

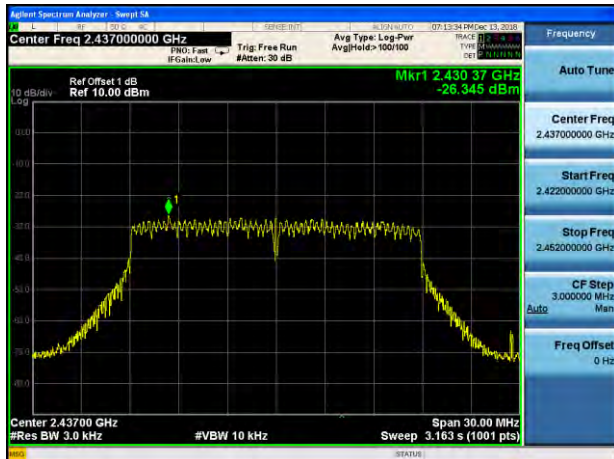

Middle channel

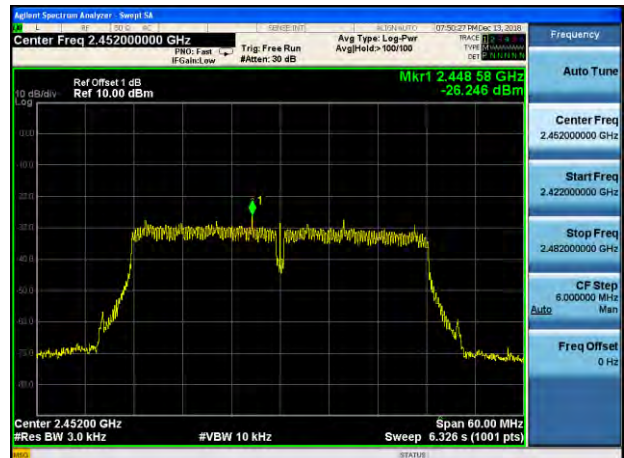
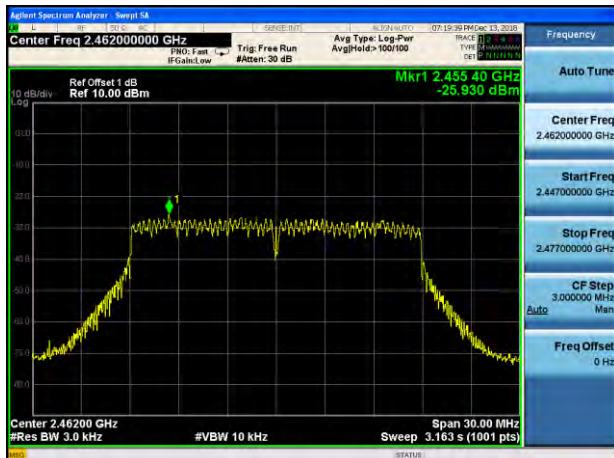

Highest channel

## 7. BANDWIDTH

### 7.1. Test limits

Please refer section 15.247

For direct sequence systems, the minimum 6dB bandwidth shall be at least 500 kHz.

### 7.2. Test Procedure

Details see the KDB558074 D01 Meas Guidance V04

- a) The bandwidth is measured at an amplitude level reduced 20dB from the reference level. The reference level is the level of the highest amplitude signal observed from the transmitter at the fundamental frequency. Once the reference level is established, the equipment is conditioned with typical modulating signal to produce the worst-case (i.e. the widest) bandwidth.
- b) The test receiver set  $RBW = 100\text{kHz}$ ,  $VBW \geq 3 * RBW = 300\text{kHz}$ , Peak Detector, Sweep time set auto, detail see the test plot.

### 7.3. Test Setup

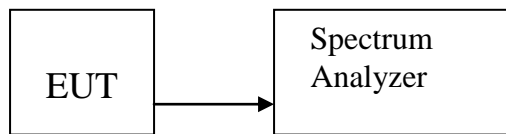

### 7.4. Test Results

IEEE 802.11b:					
Channel	Frequency (MHz)	6dB Bandwidth (MHz)	99% Occupied Bandwidth (MHz)	Limit (MHz)	Result
Low	2412	9.120	13.501	0.5	PASS
Mid	2437	9.076	13.436	0.5	PASS
High	2462	9.096	13.454	0.5	PASS
IEEE 802.11g					
Channel	Frequency (MHz)	6dB Bandwidth (MHz)	99% Occupied Bandwidth (MHz)	Limit (MHz)	Result
Low	2412	16.57	16.457	0.5	PASS
Mid	2437	16.56	16.452	0.5	PASS
High	2462	16.57	16.465	0.5	PASS
IEEE 802.11n/HT20					
Channel	Frequency (MHz)	6dB Bandwidth (MHz)	99% Occupied Bandwidth (MHz)	Limit (MHz)	Result
Low	2412	17.74	17.655	0.5	PASS
Mid	2437	17.74	17.643	0.5	PASS
High	2462	17.76	17.654	0.5	PASS
IEEE 802.11n/HT40					
Channel	Frequency (MHz)	6dB Bandwidth (MHz)	99% Occupied Bandwidth (MHz)	Limit (MHz)	Result
Low	2422	36.52	36.098	0.5	PASS
Mid	2437	36.50	36.081	0.5	PASS
High	2452	36.50	36.082	0.5	PASS



IEEE 802.11b: IEEE 802.11g:

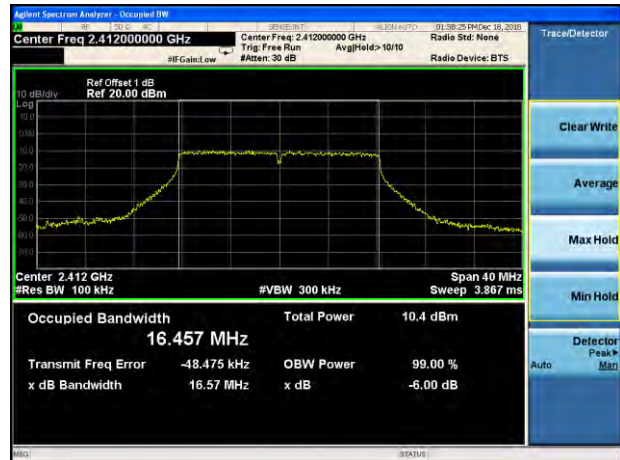

Lowest channel



Middle channel



Highest channel

**IEEE 802.11n/HT20** **IEEE 802.11n/HT40**



Lowest channel



Middle channel



Highest channel

## 8. BAND EDGE CHECK

### 8.1. Test limits

Please refer section 15.247

All the lower and upper band-edges emissions appearing within 2310MHz to 2390MHz and 2483.5MHz to 2500MHz restricted frequency bands shall not exceed the limits shown in 15.209, all the other emissions outside operation frequency band 2400MHz to 2483.5MHz and 5725MHz to 5850MHz shall be at least 20dB below the fundamental emissions, or comply with 15.209 limits.

### 8.2. Test Procedure

Details see the KDB558074 D01 Meas Guidance V04

8.2.1 Put the EUT on a 1.5m high table, power on the EUT. Emissions were scanned and measured rotating the EUT to 360 degrees, Find the maximum Emission

8.2.2 Check the spurious emissions out of band.

8.2.3 RBW 1MHz, VBW 3MHz, peak detector for peak value , RBW 1MHz ,VBW 10Hz , RMS detector for AV value.

### 8.3. Test Setup

Same as 5.2.2.

### 8.4. Test Results

PASS.

Detailed information please see the following page.

Test Mode: IEEE 802.11b-Low

Polarization: Vertical



No.	Mk.	Freq.	Reading Level	Correct Factor	Measurement	Limit	Margin	Antenna Height	Table Degree	Comment
		MHz	dBuV	dB	dBuV/m	dBuV/m	dB	cm	degree	
1	*	2412.960	111.49	-3.41	108.08	74.00	34.08	peak		
2		2390.000	53.06	-3.40	49.66	74.00	-24.34	peak		

Polarization: Horizontal

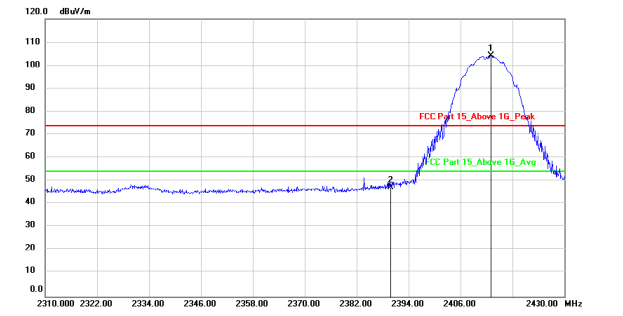

No.	Mk.	Freq.	Reading Level	Correct Factor	Measurement	Limit	Margin	Antenna Height	Table Degree	Comment
		MHz	dBuV	dB	dBuV/m	dBuV/m	dB	cm	degree	
1	*	2413.080	107.74	-3.41	104.33	74.00	30.33	peak		
2		2390.000	50.73	-3.40	47.33	74.00	-26.67	peak		

Test Mode: IEEE 802.11b-High

Polarization: Vertical

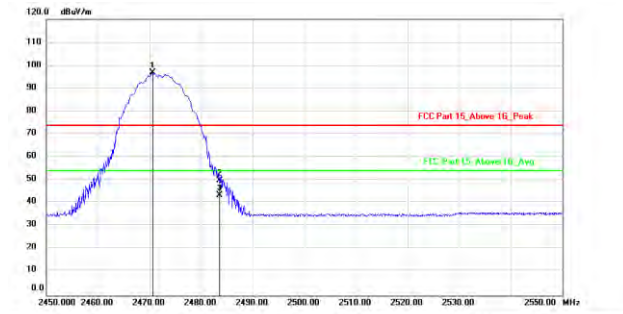

No.	Mk.	Freq.	Reading Level	Correct Factor	Measurement	Limit	Margin	Antenna Height	Table Degree	Comment
		MHz	dBuV	dB	dBuV/m	dBuV/m	dB	cm	degree	
1	*	2470.600	100.09	-3.39	96.70	74.00	22.70	peak		
2		2483.500	53.20	-3.38	49.82	74.00	-24.18	peak		
3		2483.500	46.66	-3.38	43.28	54.00	-10.72	AVG		

Polarization: Horizontal

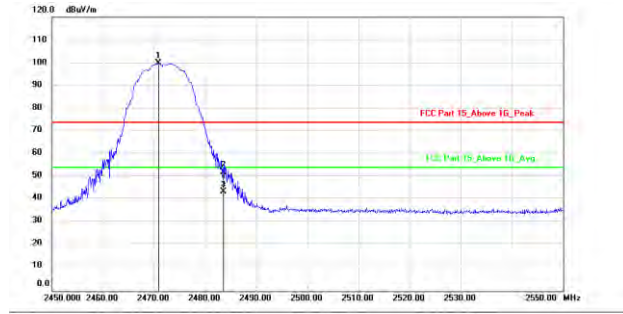

No.	Mk.	Freq.	Reading Level	Correct Factor	Measurement	Limit	Margin	Antenna Height	Table Degree	Comment
		MHz	dBuV	dB	dBuV/m	dBuV/m	dB	cm	degree	
1	*	2470.800	103.38	-3.39	99.99	74.00	25.99	peak		
2		2483.500	55.38	-3.38	52.00	74.00	-22.00	peak		
3		2483.500	46.66	-3.38	43.28	54.00	-10.72	AVG		

Test Mode: IEEE 802.11g-Low  
Polarization: Vertical

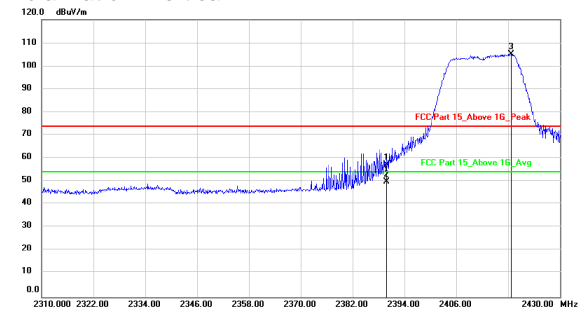

No.	Mk.	Freq.	Reading Level	Correct Factor	Measurement	Limit	Margin	Antenna Height	Table Degree	Comment
		MHz	dBuV	dB	dBuV/m	dBuV/m	dB	cm	degree	
1	*	2390.000	60.43	-3.40	57.03	74.00	-16.97			peak
2		2390.000	53.44	-3.40	50.04	54.00	-3.96			AVG
3	*	2418.720	108.46	-3.41	105.05	74.00	31.05			peak

Polarization: Horizontal

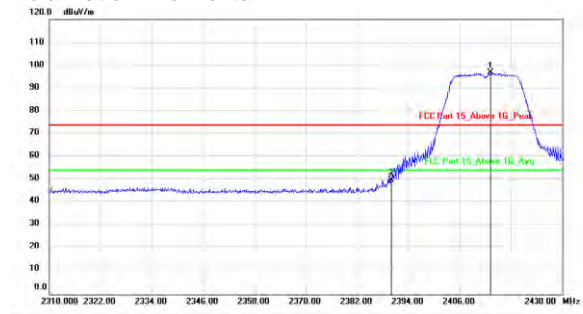

No.	Mk.	Freq.	Reading Level	Correct Factor	Measurement	Limit	Margin	Antenna Height	Table Degree	Comment
		MHz	dBuV	dB	dBuV/m	dBuV/m	dB	cm	degree	
1	*	2413.200	100.05	-3.41	96.04	74.00	22.04			peak
2		2390.000	53.46	-3.40	50.06	74.00	-23.94			peak

Test Mode: IEEE 802.11g-High  
Polarization: Vertical

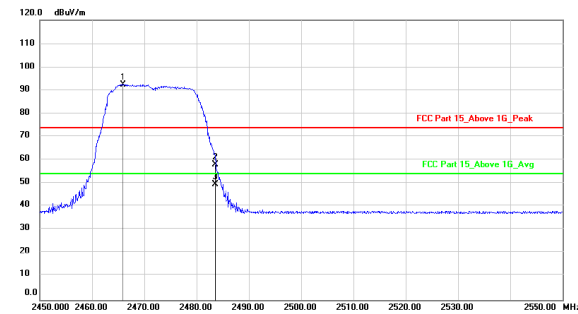

No.	Mk.	Freq.	Reading Level	Correct Factor	Measurement	Limit	Margin	Antenna Height	Table Degree	Comment
		MHz	dBuV	dB	dBuV/m	dBuV/m	dB	cm	degree	
1	*	2465.900	95.75	-3.39	92.36	74.00	18.36			peak
2		2483.500	61.44	-3.38	58.06	74.00	-15.94			peak
3		2483.500	53.01	-3.38	49.63	54.00	-4.37			AVG

Polarization: Horizontal

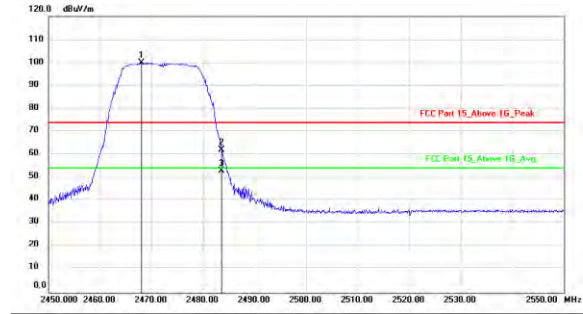

No.	Mk.	Freq.	Reading Level	Correct Factor	Measurement	Limit	Margin	Antenna Height	Table Degree	Comment
		MHz	dBuV	dB	dBuV/m	dBuV/m	dB	cm	degree	
1	*	2468.100	103.44	-3.39	100.05	74.00	26.05			peak
2		2483.500	65.47	-3.38	62.09	74.00	-11.91			peak
3		2483.500	56.40	-3.38	53.02	54.00	-0.98			AVG

Test Mode: IEEE 802.11n20-Low

Polarization: Vertical

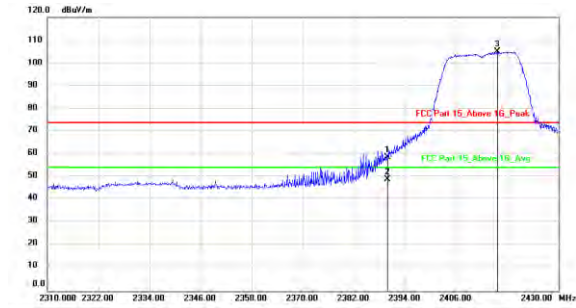

No.	Mk.	Freq.	Reading Level	Correct Factor	Measurement	Limit	Margin	Antenna Height	Table Degree
		MHz	dBuV	dB	dBuV/m	dBuV/m	dB	cm	degree
1	*	2390.000	62.00	-3.40	58.60	74.00	-15.40	peak	
2		2390.000	52.46	-3.40	49.06	54.00	-4.94	AVG	
3	*	2415.600	108.64	-3.41	105.23	74.00	-31.23	peak	

Polarization: Horizontal

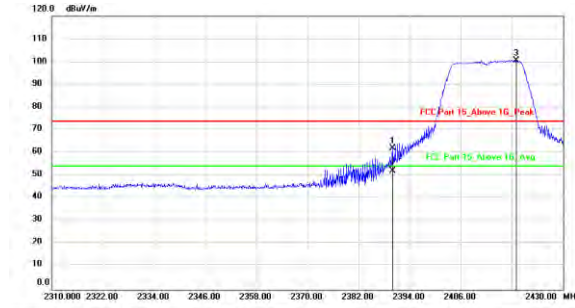

No.	Mk.	Freq.	Reading Level	Correct Factor	Measurement	Limit	Margin	Antenna Height	Table Degree
		MHz	dBuV	dB	dBuV/m	dBuV/m	dB	cm	degree
1	*	2390.000	65.36	-3.40	61.96	74.00	-12.04	peak	
2		2390.000	55.41	-3.40	52.01	54.00	-1.99	AVG	
3	*	2418.960	104.20	-3.41	100.79	74.00	-26.79	peak	

Test Mode: IEEE 802.11n20-High

Polarization: Vertical

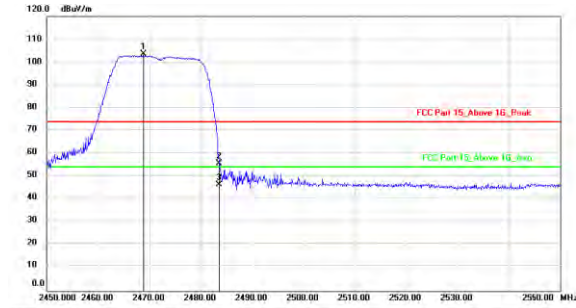

No.	Mk.	Freq.	Reading Level	Correct Factor	Measurement	Limit	Margin	Antenna Height	Table Degree
		MHz	dBuV	dB	dBuV/m	dBuV/m	dB	cm	degree
1	*	2468.800	106.93	-3.39	103.54	74.00	-29.54	peak	
2		2483.500	59.09	-3.38	55.71	74.00	-18.29	peak	
3		2483.500	49.66	-3.38	46.28	54.00	-7.72	AVG	

Polarization: Horizontal

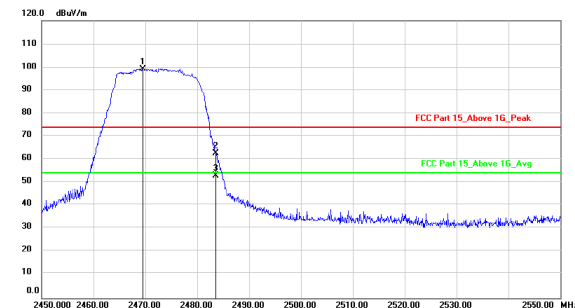

No.	Mk.	Freq.	Reading Level	Correct Factor	Measurement	Limit	Margin	Antenna Height	Table Degree
		MHz	dBuV	dB	dBuV/m	dBuV/m	dB	cm	degree
1	*	2469.500	102.67	-3.39	99.28	74.00	-25.28	peak	
2		2483.500	65.97	-3.38	62.59	74.00	-11.41	peak	
3		2483.500	56.36	-3.38	52.98	54.00	-1.02	AVG	

Test Mode: IEEE 802.11n40-Low  
Polarization: Vertical

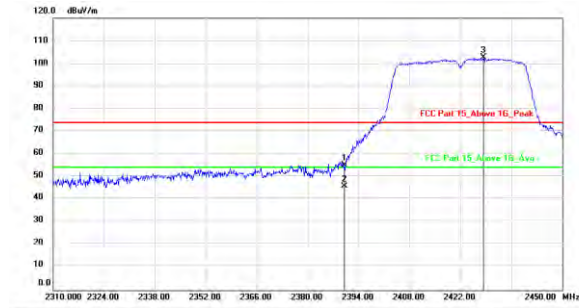

No.	Mk.	Freq.	Reading Level	Correct Factor	Measurement	Limit	Margin	Antenna Height	Table Degree	Comment
		MHz	dBuV	dB	dBuV/m	dBuV/m	dB	cm	degree	
1	*	2390.000	56.36	-3.40	54.96	74.00	-19.02			peak
2		2390.000	49.03	-3.40	45.63	54.00	-8.37			AVG
3	*	2428.160	106.09	-3.40	102.69	74.00	28.69			peak

Polarization: Horizontal

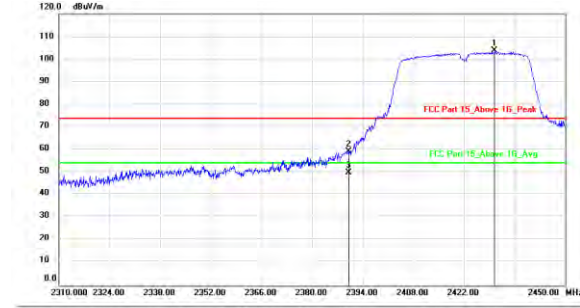

No.	Mk.	Freq.	Reading Level	Correct Factor	Measurement	Limit	Margin	Antenna Height	Table Degree	Comment
		MHz	dBuV	dB	dBuV/m	dBuV/m	dB	cm	degree	
1	*	2430.540	107.30	-3.40	103.90	74.00	29.90			peak
2		2390.000	62.59	-3.40	59.19	74.00	-14.81			peak
3		2390.000	53.29	-3.40	49.89	54.00	-4.11			AVG

Test Mode: IEEE 802.11n40-High  
Polarization: Vertical

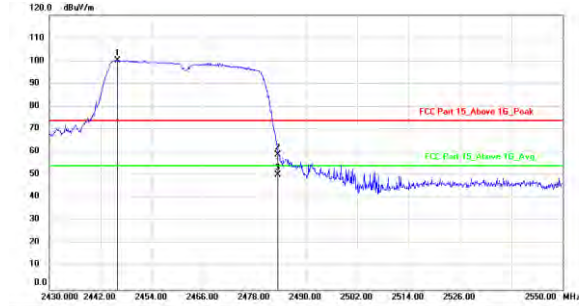

No.	Mk.	Freq.	Reading Level	Correct Factor	Measurement	Limit	Margin	Antenna Height	Table Degree	Comment
		MHz	dBuV	dB	dBuV/m	dBuV/m	dB	cm	degree	
1	*	2445.960	103.87	-3.40	100.47	74.00	26.47			peak
2		2483.500	62.40	-3.38	59.02	74.00	-14.98			peak
3		2483.500	53.63	-3.38	50.25	54.00	-3.75			AVG

Polarization: Horizontal

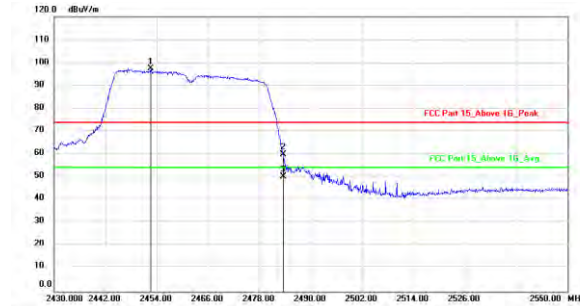

No.	Mk.	Freq.	Reading Level	Correct Factor	Measurement	Limit	Margin	Antenna Height	Table Degree	Comment
		MHz	dBuV	dB	dBuV/m	dBuV/m	dB	cm	degree	
1	*	2452.560	100.67	-3.39	97.28	74.00	23.28			peak
2		2483.500	63.22	-3.38	59.84	74.00	-14.16			peak
3		2483.500	53.74	-3.38	50.36	54.00	-3.64			AVG

Note: 1. \*:Maximum data; x:Over limit; !:over margin.  
2.Measurement=Reading Level+Correct Factor; Correct Factor=Antenna Factor+Cable Loss.

Test mode: 802.11b

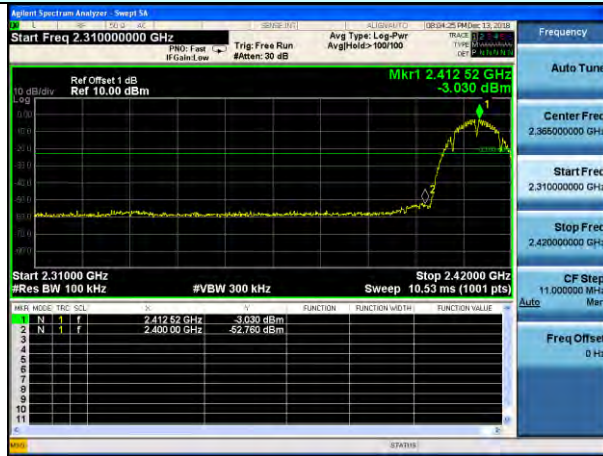

Lowest channel

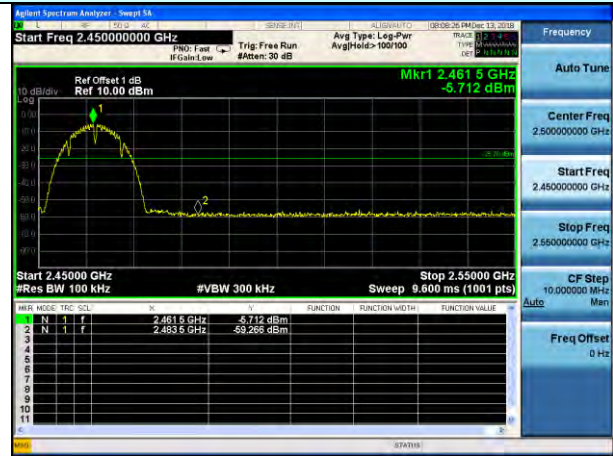

Highest channel

Test mode: 802.11g



Lowest channel



Highest channel



Test mode: 802.11n(HT20)



Lowest channel



Highest channel

Test mode: 802.11n(HT40)



Lowest channel

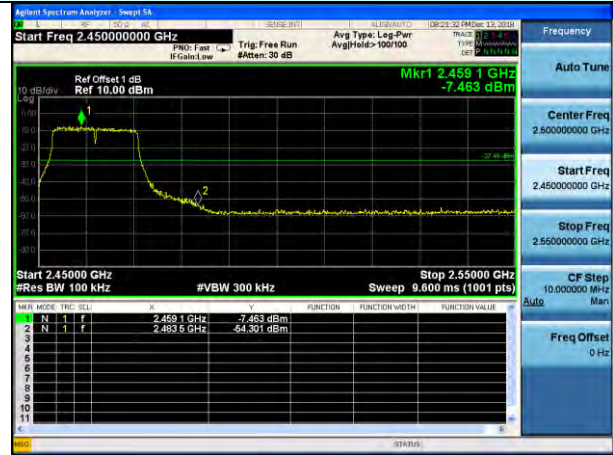

Highest channel

## **9. ANTENNA REQUIREMENT**

### **9.1. Standard Requirement**

An intentional radiator shall be designed to ensure that no antenna other than that furnished by the responsible party shall be used with the device. The use of a permanently attached antenna or of an antenna that uses a unique coupling to the intentional radiator shall be considered sufficient to comply with the provisions of this Section. The manufacturer may design the unit so that a broken antenna can be replaced by the user, but the use of a standard antenna jack or electrical connector is prohibited.

### **9.2. Antenna Connected Construction**

The PCB antenna is unique antenna and no consideration of replacement. Please see EUT photo for details.

### **9.3. Results**

The EUT antenna is PCB Antenna. It complies with the standard requirement.

## 10. TEST SETUP PHOTO

### 10.1. Photos of Radiated emission

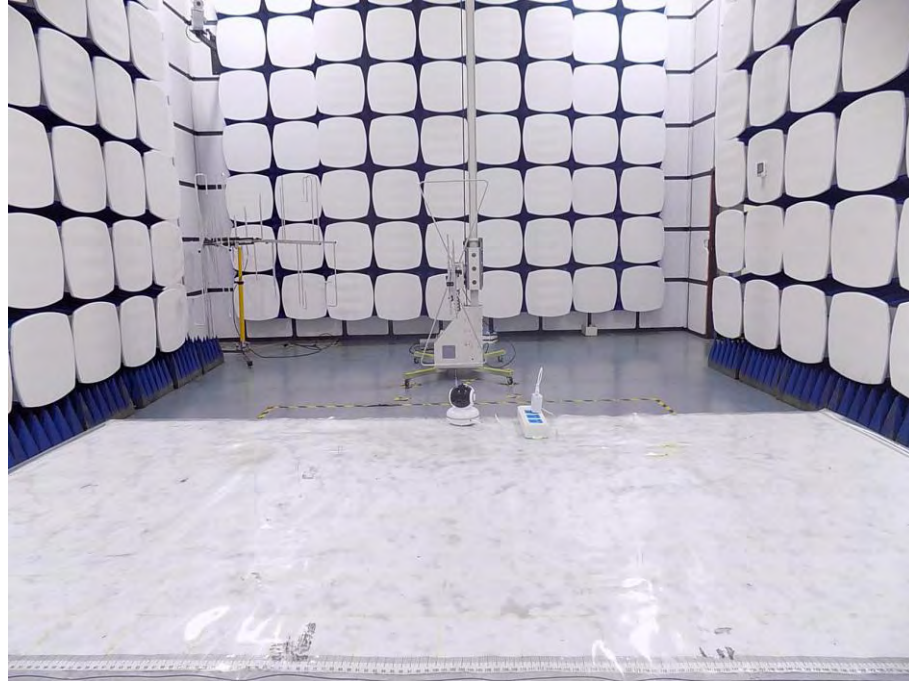

### 10.2.Photos of Conducted Emission test



# 11.EUT PHOTO













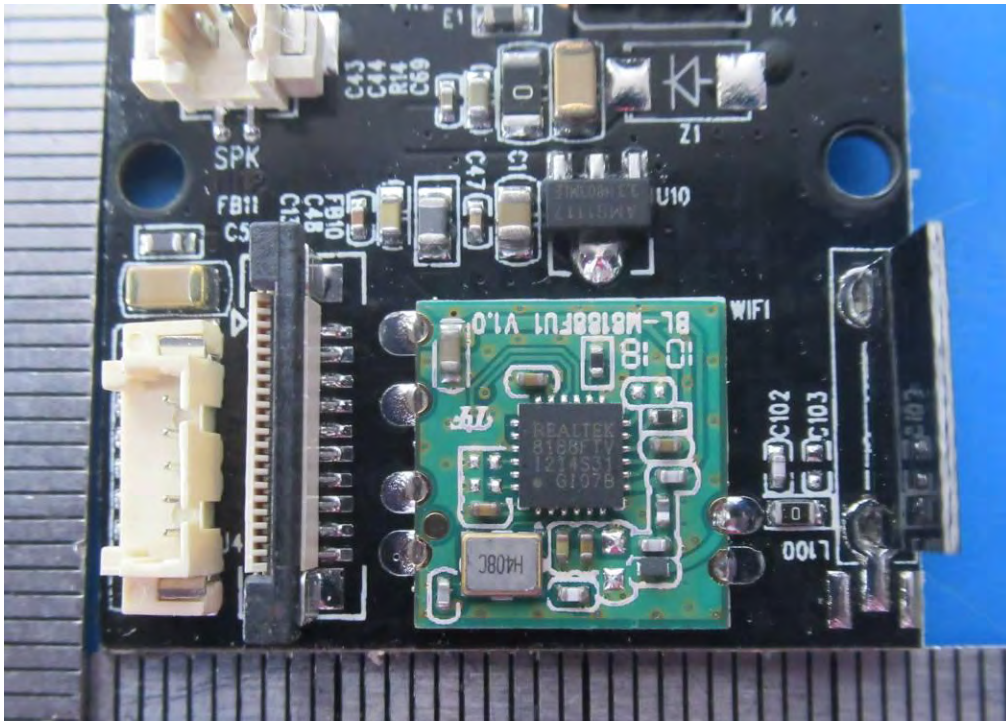
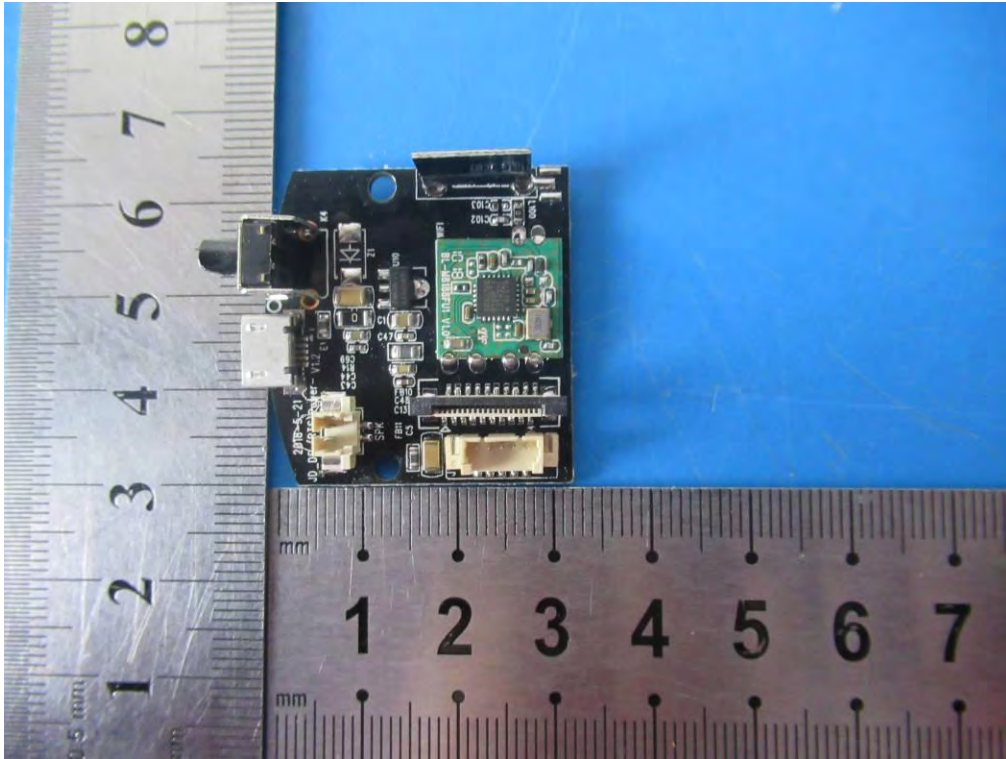

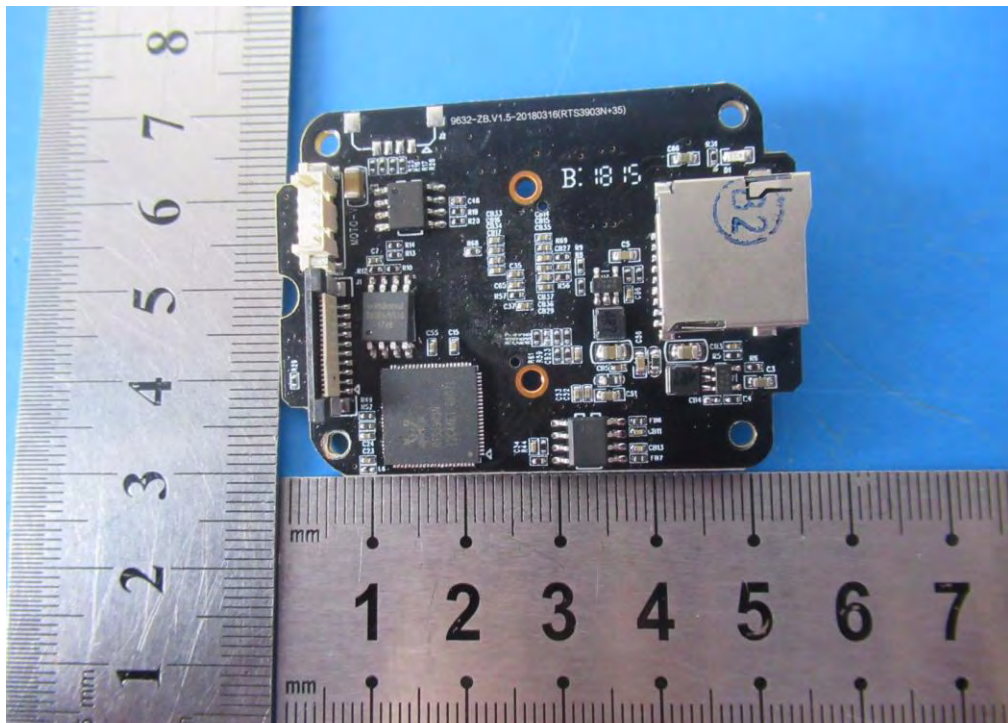
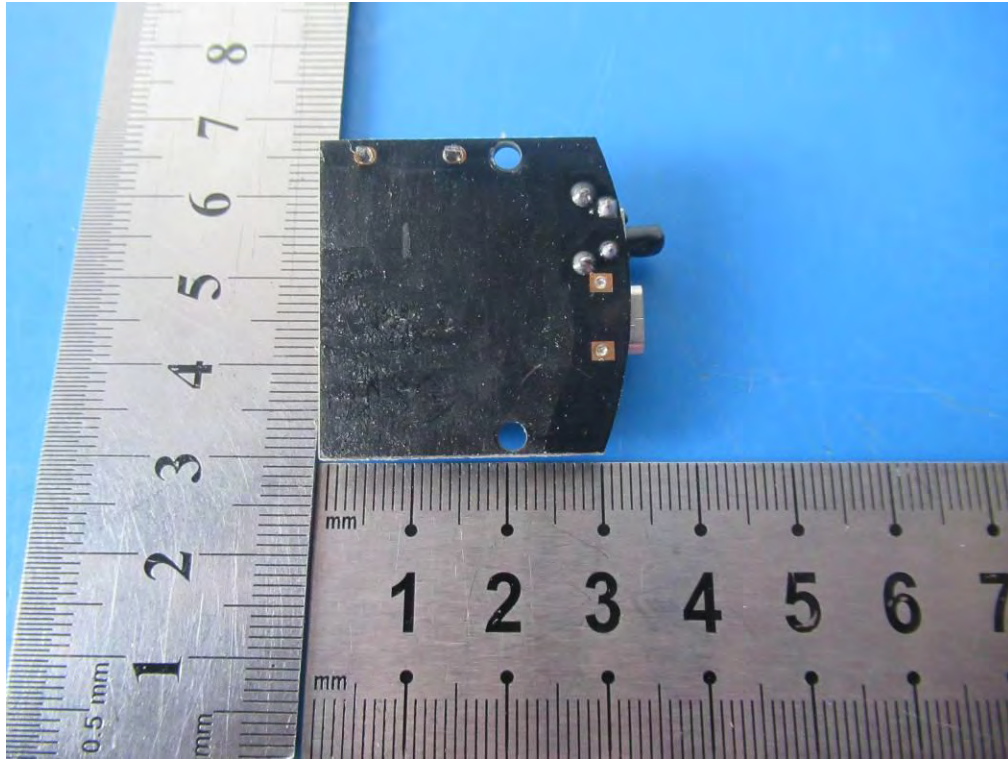

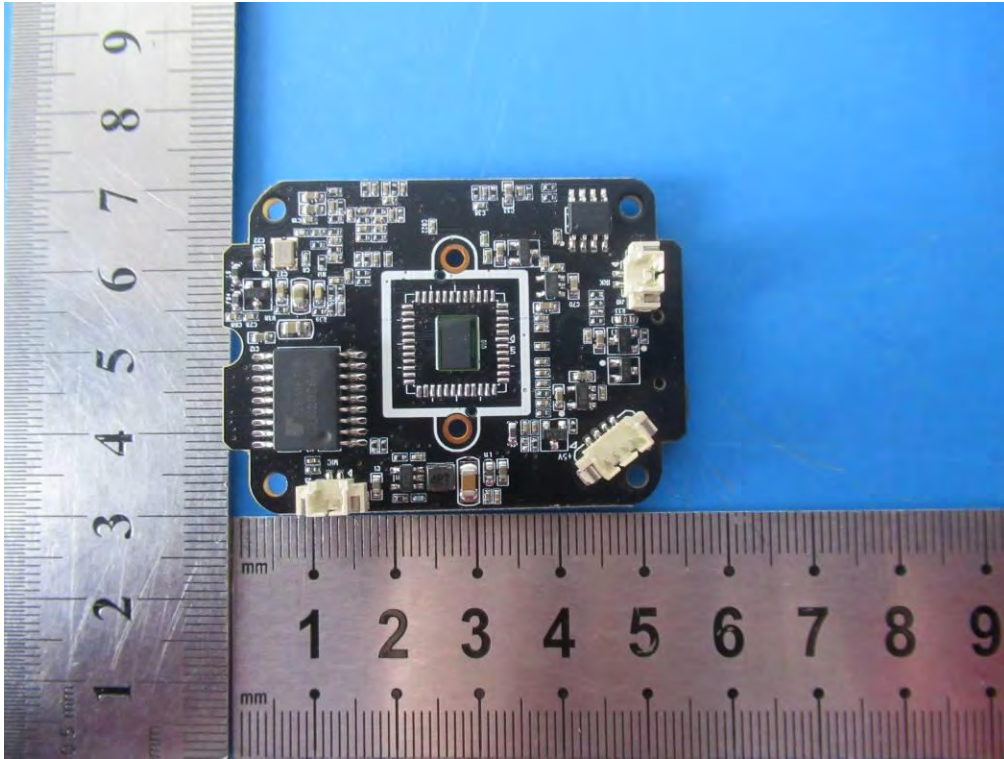

-----THE END OF REPORT-----