



MLU-X1001 Accelerator

Product Manual

V0.9.3

2020.10.30



Direct

1. Preface.....	1
1.1. Copyright Declaration.....	1
1.2. Versioning.....	2
1.3. Update history.....	2
2. Overview.....	3
3. Product Specification Overview.....	4
3.1 Overview of Product Specification Parameters.....	4
3.2 Overview of structural specifications.....	4
3.3 Overview of electrical specifications.....	5
3.4 Summary of heat dissipation specifications.....	6
4. Component Profile.....	7
4.1 MLUX-BB 1.....	7
4.2 MLUX -PA4.....	9
4.3 MLUX -PDB.....	9
4.4 MLUX -LINKB.....	10
4.5 MLUX -IBB.....	10
4.6 Front panel.....	11
4.7 Back panel.....	12
5. Electrical specifications.....	13
5.1 PCIE topology description.....	13
5.2 MLU-LINK interface description.....	14
5.3 Power Interface Description.....	16
6. BMC management system.....	18

- 6.1 BMC function description.....18
- 7. Heat dissipation specifications.....19
 - 7.1 Description of the heat dissipation environment.....19
 - 7.2 Wind resistance curve of MLU-X1001..... 20
- 8. Optional components.....21
 - 8.1 PCIE High Speed Cable..... 21
 - 8.2 MLU-LINK High Speed Cable..... 21
 - 8.3 Network..... 21
 - 8.4 Hard disk.....22
- 9. Cambricon NeuWare development environment.....23
- 10. Compliance.....24



1. Preface

1.1. Copyright Declaration

Disclaimer

Cambricon Technologies Corporation Limited(hereinafter referred to as "Cambricon ") does not represent, guarantee (express, implied or statutory) or guarantee the information contained in this document and expressly waives any and all implied guarantees of saleability, ownership, non-aggression of intellectual property or applicability for a specific purpose, and cambricon does not assume any liability arising from the application or use of any product or service. cambricon shall not be liable for any breach of contract, damages, costs or problems arising from :(1) any way of using cambricon products contrary to this Guide; or (2) customer product design.

Limitation of liability

In no case shall Cambricon be liable for any damage caused by the use or inability to use this Guide (including but not limited to damage such as loss of profits, business disruption and loss of information), even if Cambricon has been advised that such damage may be suffered. Although the customer may suffer any damage for any reason, according to the terms and conditions of sale of the products of the Cambricon, the total and cumulative liability of Cambricon to the customer for the products described in this Guide shall be limited.

Accuracy of information

The information provided in this document is owned by Cambricon and Cambricon reserves the right to make any changes to this document information or to any products and services without notice. The information contained in this guide and all other information of the Cambricon documents cited in this guide are provided "as is ". Cambricon does not guarantee the accuracy or completeness of information, texts, patterns, links or other items contained in this guide. Cambricon may make changes to this Guide or to the products described in this Guide without notice, but does not undertake to update this Guide.

The performance tests and grades listed in this guide are to be measured using a specific chip or computer system or component. After such tests, the results shown in this guide reflect the general performance of Cambricon products. Any difference in system hardware or software design or configuration will affect actual performance. As mentioned above, Cambricon does not represent, warrant or guarantee that the products described in this Guide will apply for any particular purpose.Cambricon does not represent or guarantee testing all parameters of each product.The customer is solely responsible for ensuring that the product is suitable and applicable to the application of the customer plan and for performing the necessary

tests on the application, with a view to avoiding the default of the application or product.

The fragility of customer product design can affect the quality and reliability of Cambricon products and lead to additional or different circumstances and/or requirements beyond the scope of this guide.

Notice of Intellectual Property

The Cambricon and Cambricon symbols are trademarks and/or registered trademarks of Cambricon Technologies Corporation Limited in the United States and other countries. Other companies and product names shall be trademarks of the respective companies associated with them.

This guide is copyrighted and protected by the provisions of copyright laws and treaties worldwide. This guide can not be reproduced, reworked, modified, published, uploaded, published, transmitted or distributed in any way without the prior written permission of Cambricon. Except for the customer’s right to use this guide information and products, according to this guide, Cambricon does not grant any other express or implied rights or permits. It is doubtful that the Cambricon does not grant any (express or implied) rights or permits to the customer based on any patent, copyright, trademark, trade secret or any other Cambricon intellectual property or ownership.

Copyright Declaration

© Cambricon Technologies Corporation Limited reserves all rights.

1.2. Versioning

Table 1.1 Version Record

Document name	MLU-X1001 accelerator Product Manual
Version number	V0.9.3
Author	Cambricon
Date created	2020.10.30

1.3. Update history

V0.2.0

Update time: 2020.07.10

Update:

- Initial version.

V0.93

Update time: 2020.10.30

Update:

- Modify the external interconnection name as MLU-Link, update the HBM rate, and add warning of the button battery.

MLU-X1001 accelerator is a construction unit of artificial intelligence supercomputing. The extender inherits 4 MLU290-M5 intelligent accelerating cards, and provides up to 2 POPs of adaptive precision computing power. The supercomputing system from 4 cards to 16 cards is constructed by using the Cambrian MLU-LINK inter chip direct connection technology, which provides a highly agile, highly reliable and high-performance computing foundation for the Artificial Intelligence Computing Center.





3. Product Specification Overview

3.1 Overview of Product Specification Parameters

MLU-X1001 accelerator Specification Parameters are as follows :

Table 3.1 MLU-X1001 Specification Parameters

Specification indicators	Note
Model	MLU-X1001
Core architecture	Cambricon MLUv02
Core frequency	1.3GHz
Calculation accuracy support	INT16,INT8,INT4,FP32,FP16
Video decoding	Support
Memory capacity	192GB
ECC protection	Yes
System interface	2* PCI Express 4.0x16
MLU-LINK external interface	8Ports
MLU-LINK interface bandwidth	8*100 GB /S
TDP power consumption	2300W
Heat dissipation scheme	Air-cooled, compatible with liquid-cooled

3.2 Overview of structural specifications

The structure specifications of the MLU-X1001 accelerator are as follows:

Table 3.2 Structural Specification for MLU-X1001

Specification indicators	Note
Shape	437mm*87mm*735mm

Weight	29Kg
Package Shape	1000mm*635mm*230mm
Package Weight	39Kg

Bending radius of cable:

Table 3.3 Specification for cable bending

Wire diameter	Bending radius L1 (Base on the cabinet column)	Bending radius L2 (Base on the chassis)
30 AWG	97.45 mm	78.5 mm
26 AWG	121.64 mm	102.7 mm

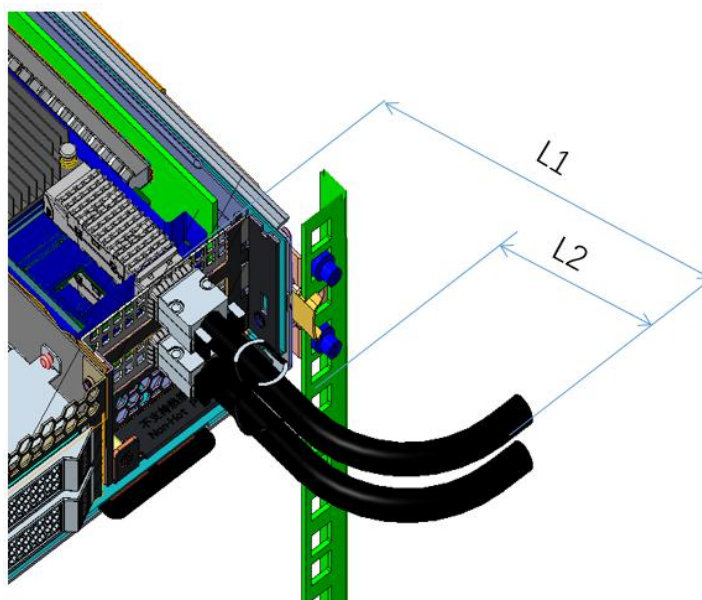

Figure 3.1 Bending radius of cable

3.3 Overview of electrical specifications

MLU-X1001 accelerator electrical specifications as follows:

Table 3.4 Electrical Specification for MLU-X1001

Specification indicators	Note
System interface	PCIE Gen 4X 16
Number of PCIE ports	2Ports
PCIE bandwidth	128GB /s
Number of MLU-LINK ports	8Ports
MLU-LINK bandwidth	800GB /s

BMC management interface	IPMI V2.0
Host management interface	SMBUS
Input voltage	AC 115-127V,14,2A, 60/50Hz AC 200-240V,14.9A, 60/50Hz DC 240V, 16A(China mainland only)

3.4 Summary of heat dissipation specifications

The heat dissipation specification of MLU-X1001 accelerator is as follows:

Table 3.4 Heat dissipation specifications of MLU-X1001

Specification indicators	Note
Working temperature	0°C -35°C, altitude of 900m below
Working humidity	20%RH-85%RH
Storage temperature	-40°C—75°C
Storage humidity	5%RH-95%RH
Noise	SDP @23°C, sound power ≤ 7.2 bels
Working altitude	≤ 3000 m (900-3000m, for each increase of 300 m supported working temperature drop 1°C)

4.1 MLUX-BB 1

MLUX-BB 1 is the baseboard which carries MLU290-M5 Intelligent processing card. Each MLUX-BB 1 can carry 4 MLU290-M5 intelligent accelerating cards. The details are shown in the following figure:

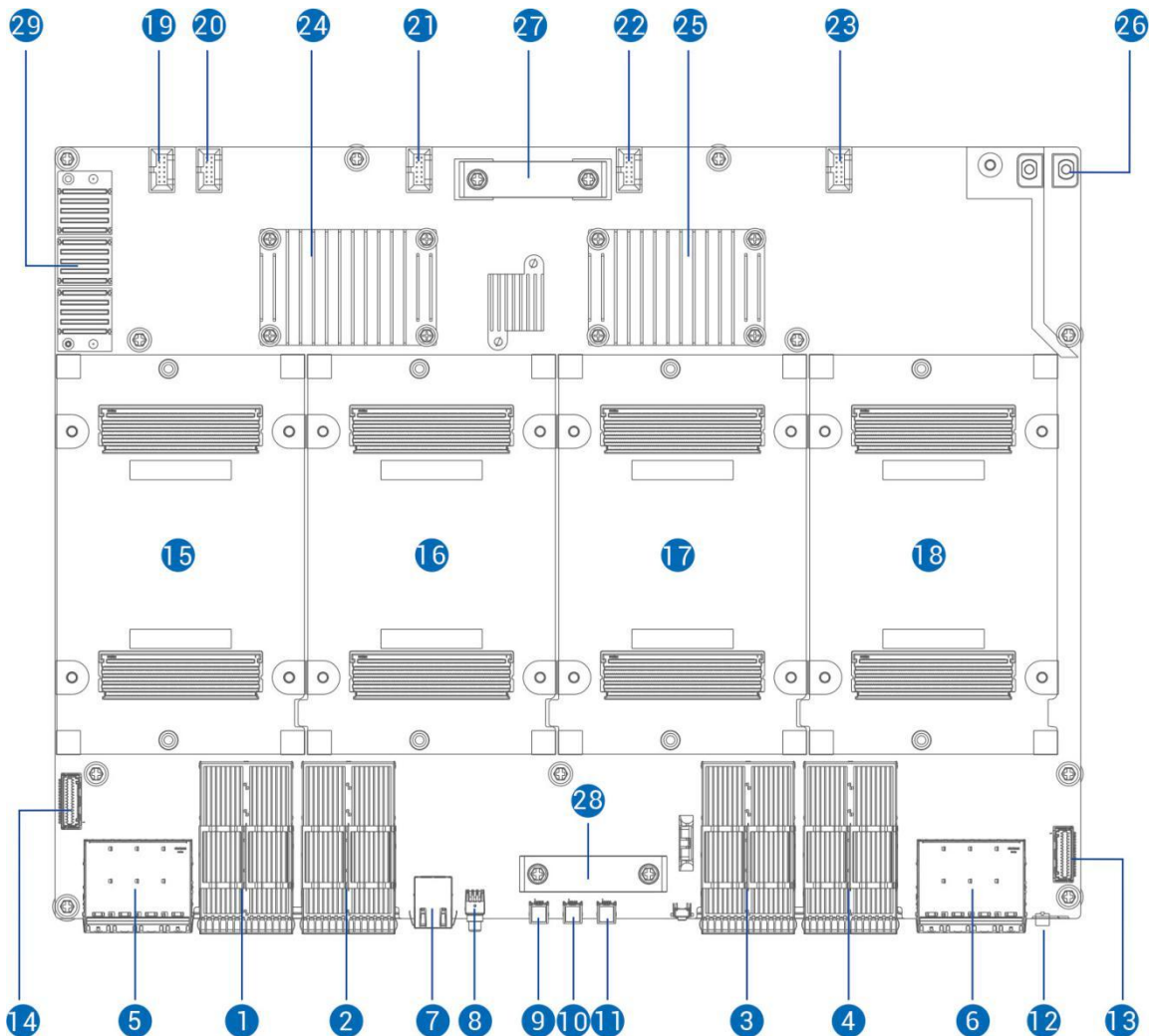

Figure 4.1 MLUX -BB1 graphic

Table 4.1 MLUX -BB1 Description

Serial	Note	Serial	Note
--------	------	--------	------

number		number	
1	MLU-LINK-0A &0B	16	OAM MODULE 2
2	MLU-LINK-2A &2B	17	OAM MODULE 1
3	MLU-LINK-1A &1B	18	OAM MODULE 3
4	MLU-LINK-1A &1B	19	F AN 4
5	PCIE 0	20	F AN 3
6	PCIE 1	21	F AN 2
7	IPMI	22	F AN 1
8	UID	23	F AN 0
9	COM HUB0	24	PCIE SWITCH 0
10	COM HUB1	25	PCIE SWITCH 1
11	COM HUB2	26	54V POWER BUSBAR
12	AC INDICATOR	27	HANDLE 0
13	FRONT PANEL CONN.	28	HANDLE 1
14	PDB MGT.CONN.	29	FRONT PCIE CONN.
15	OAM MODULE 0		

4.2 MLUX -PA4

MLUX -PA4 is a PCIE board, which is placed on the host server and provides Mini SAS HD interface for connection with MLU-X1001. The details are shown in the following figure:

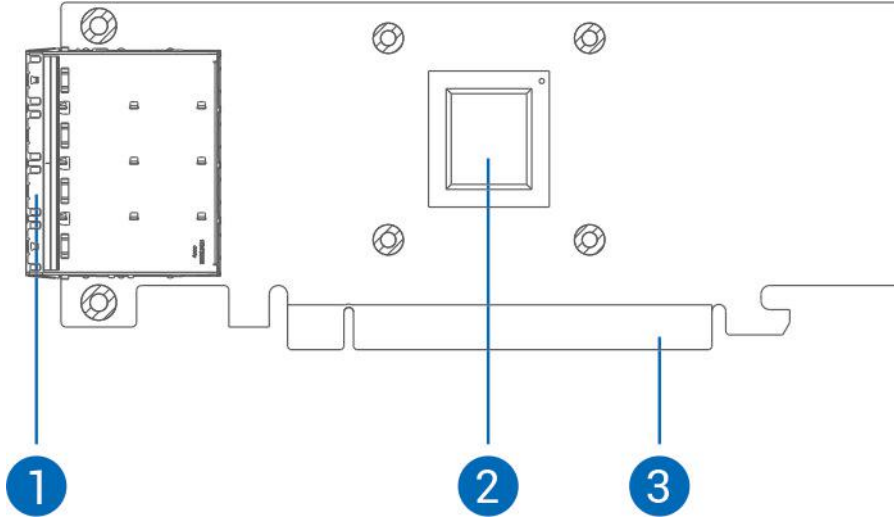

Figure 4.2 MLUX -PA4 graphic

Table 4.2 MLUX -PA4 Description

Serial number	Note	Serial number	Note
1	mini SAS HD CONN.	3	PCIE GOLDEN FINGER
2	PCIE RETIMER		

4.3 MLUX -PDB

MLUX -PDB is the power distribution board. The details are shown in the following figure:

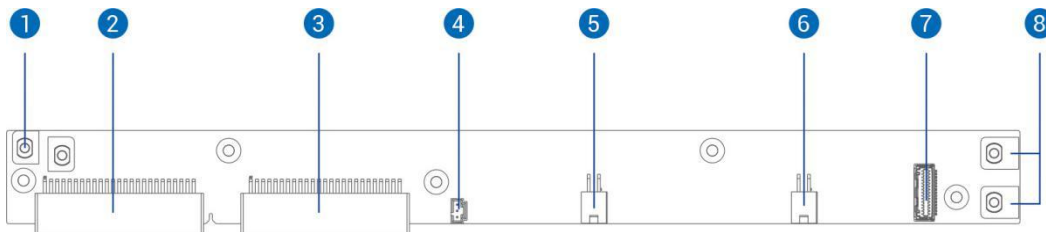

Figure 4.3 MLUX -PDB graphic

Table 4.3 MLUX -PDB Description

Serial number	Note	Serial number	Note
---------------	------	---------------	------

1	54V POWER BUSBAR	5	SSD POWER CONN.0
2	PSU CONN.0	6	SSD POWER CONN.1
3	PSU CONN.1	7	PDB MGT.CONN.
4	INTRUTION	8	12V POWER BUSBAR

4.4 MLUX -LINKB

MLUX -LINKB is passive connection board.The details are shown in the following figure:

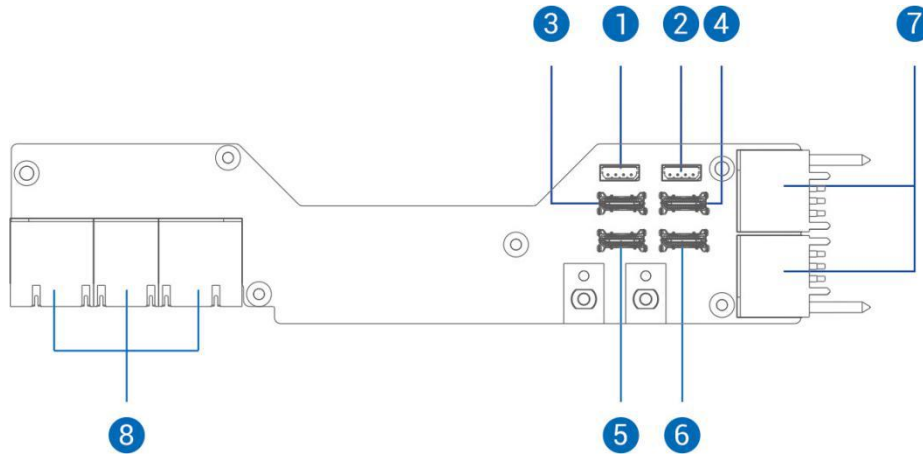

Figure 4.4 MLUX -LINK B graphic

Table 4.4 MLUX -PDB Description

Serial number	Note	Serial number	Note
1	SSD MGT.CONN.0	5	OCULINK 2
2	SSD MGT.CONN.1	6	OCULINK 3
3	OCULINK 0	7	IBB CONN.
4	OCULINK 1	8	FRONT PCIE CONN.

4.5 MLUX -IBB

MLUX-IBB is the backplane of Infiniband card. Each MLUX-IBB can place two Infiniband cards.The details are shown in the following figure:

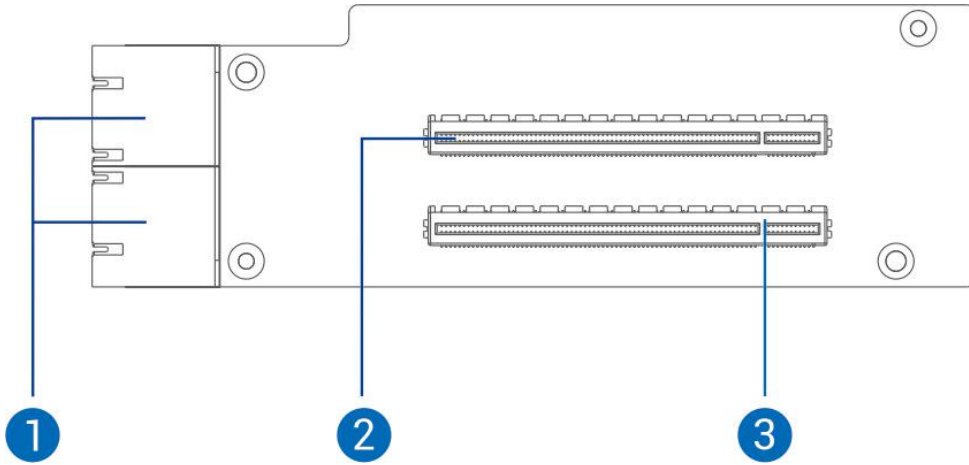

Figure 4.5 MLUX -IBB graphic

Table 4.5 MLUX-IBB Description

Serial number	Note	Serial number	Note
1	IBB CONN.	3	IB SLOT 1
2	IB SLOT 0		

4.6 Front panel

The front panel of the chassis is shown as follows:

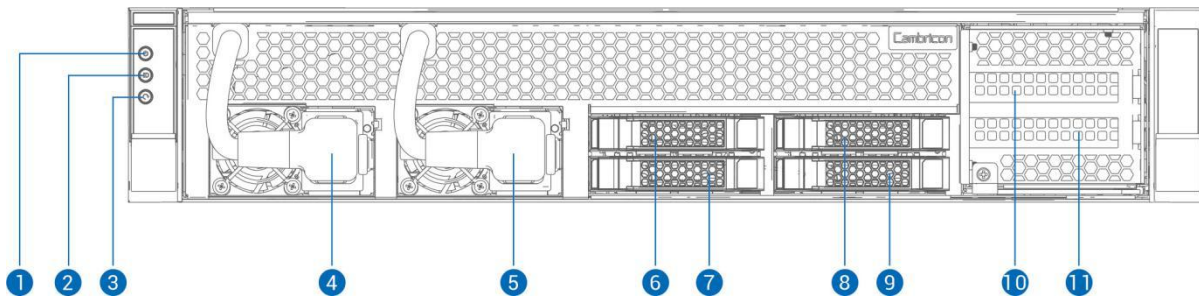

Figure 4.6 Front panel of chassis

Table 4.6 Description of front panel of chassis

Serial number	Note	Serial number	Note
1	Switching keys	7	SSD 1
2	UID keys	8	SSD 2
3	Reset button	9	SSD 3
4	PSU 0	10	NIC 0
5	PSU 1	11	NIC 1

6	SSD 0		
---	-------	--	--

4.7 Back panel

The rear panel of the chassis is shown as follows:

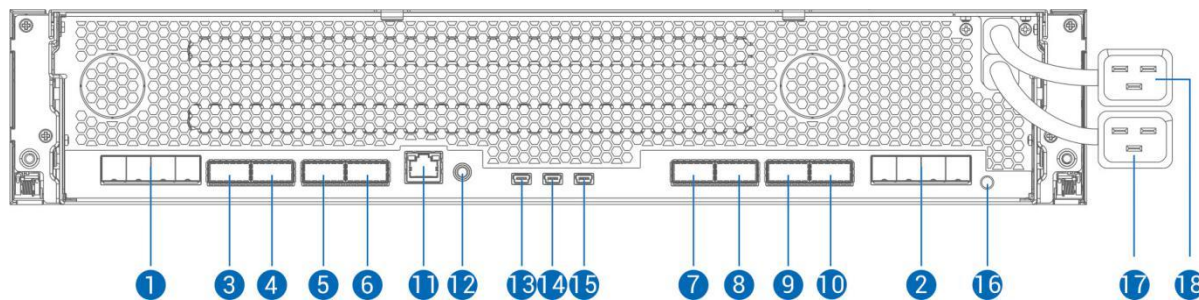

Figure 4.7 Rear panel of chassis

Table 4.7 Description of rear panel of chassis

Serial number	Note	Serial number	Note
1	PCIE 0	10	MLU-LINK-3B
2	PCIE 1	11	IPMI
3	MLU-LINK-0A	12	UID
4	MLU-LINK-0B	13	COM HUB 0
5	MLU-LINK-2A	14	COM HUB 1
6	MLU-LINK-2B	15	COM HUB 2
7	MLU-LINK-1A	16	AC INDICATOR
8	MLU-LINK-1B	17	POWER CORD 0
9	MLU-LINK-3A	18	POWER CORD 1

Cambricon 寒 武 纪

5. Electrical specifications

5.1 PCIe topology description

MLU-X1001 accelerator uses 2 miniSAS HD interfaces to connect with the host server, and there are 2 PCIe switching chips to connect the PCIe devices inside. PCIe interconnection topology is shown as follows:

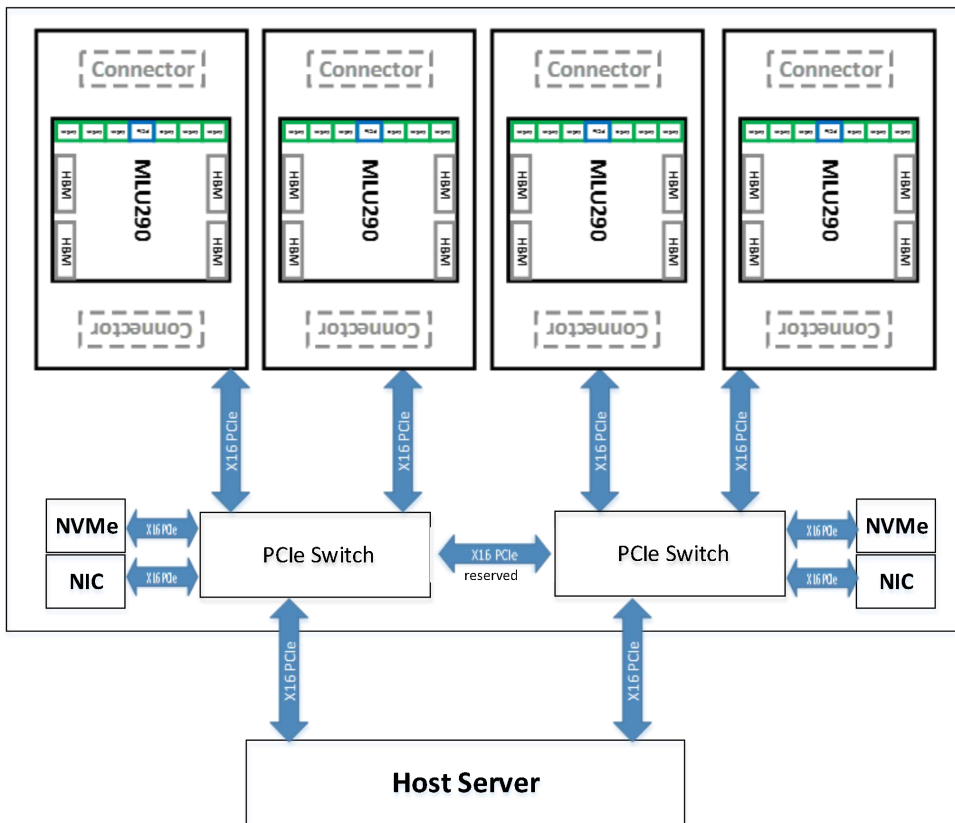

Figure 5.1 PCIe Connection topology

PCIe signal rate is 16 Gbps, and the cable loss is controlled within 15 dB @8GHz. It is recommended to use 1 meter cable with a diameter of 30 AWG.

The pins of the miniSAS HD connectors used by PCIe interfaces are defined as follows:

Table 5.1 PCIe Interface pin definition

miniSAS HD pin	Note	Pin internal processing
RX [15:0]P/N	PCIe input signal	External AC coupling capacitance
TX [15:0]P/N	PCIe output signal	External AC coupling capacitance
SMCLK	SMBUS interface clock signal	4.7 K Ω pull-up to 3.3 V
SMDAT	SMBUS interface data signal	4.7 K Ω pull-up to 3.3 V
PERST#	Reset signal	
REFCLK P/N	PCIe clock signal	
PRESENT	Opposite side in position detection signal	4.7 K Ω pull-up to 3.3 V

5.2 MLU-LINK interface description

MLU-X1001 accelerator is equipped with 4 MLU290-M5 intelligent accelerating cards, each card has 6 MLU-LINK ports. Among them, 4 ports are used for internal interconnection and 2 ports are used for external interconnection. The MLU-LINK interconnection topology between the internal cards is as follows:

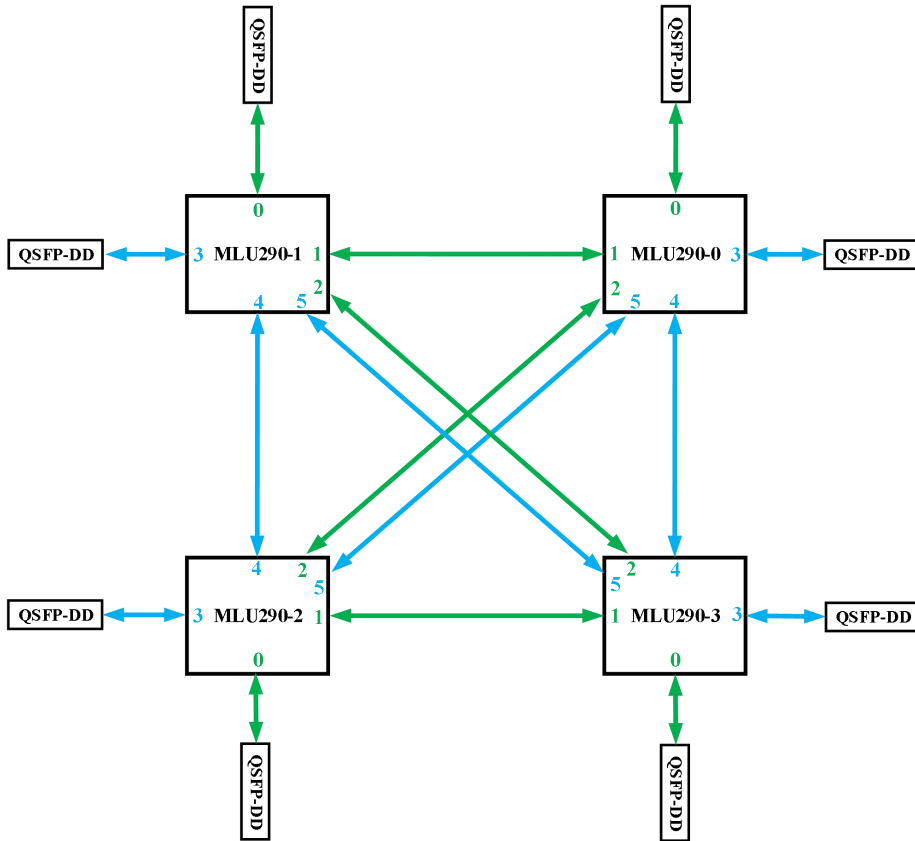

Figure 5.2 MLU-LINK internal connection topology

MLU-LINK interconnection between extenders refer to the following figure:

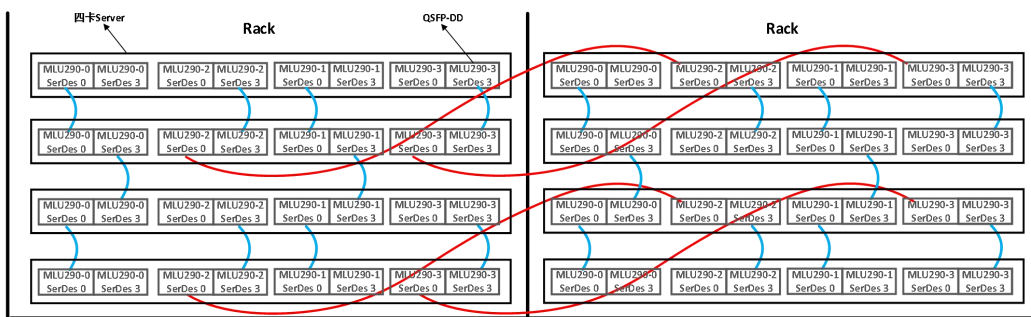

Figure 5.3 External MLU-LINK connection reference

The signal rate of MLU-LINK is 50 Gbps, and the cable loss is controlled within 10 dB @12.5GHz. It is recommended to use 1 meter cable with a diameter of 30 AWG or 2 meter cable with a diameter of 28 AWG .

MLU-LINK interface uses QSFP DD connectors whose pins are defined as follows:

Table 5.2 MLU-LINK Interface pin definition

QSFP-DD pins	Note	Internal processing of
--------------	------	------------------------

		pins
RX [8:1]P/N	SERDES signal input with AC coupling capacitance inside	External AC coupling capacitance is not required
TX [8:1]P/N	SERDES signal output with AC coupling capacitance inside	External AC coupling capacitance is not required
SCL	I2C interface clock signal of optical module	4.7 KΩ pull-up to 3.3 V
SDA	I2C interface data signal of optical module	4.7 KΩ pull-up to 3.3 V
ModPrsL	Optical module in position signal output	4.7 KΩ pull-up to 3.3 V
ModSelL	Selection signal of optical module, default pull- up inside	1KΩ pull-down to GND
ResetL	Reset signal, low level effective	4.7 KΩ pull-up to 3.3 V
IntL	Interrupt signal of optical module, OC gate, low level indicates an interrupt signal	4.7 KΩ pull-up to 3.3 V
InitMode	Initialization mode	1KΩ pull-down to GND
VccRx,VccRx1,Vcc1,Vcc2 VccTx ,VccTx1	Power signal	

5.3 Power Interface Description

MLU-X1001 accelerator Input Power Requirements:

Table 5.3 MLU-X1001 Input Power Supply Specifications

Input voltage	Max. Input Current
AC 115-127V,60/50Hz	14.2A
AC 200-240V,60/50Hz	14.9A
DC 240V (China mainland only)	16A

MLU-X1001 accelerator is able to reduce power consumption adjustment for instantaneous power changes above the μs level. The power regulator can support power fluctuations within the ms level (e.g .1.2 x TDP).

Table 5.4 EDPp specifications of MLU-X1001

EDP	Duration
TBD	TBD



6. BMC management system

The BMC management system of MLU-X1001 is compatible with server management standards IPMI 2.0, with high reliability of hardware monitoring and management functions.

6.1 BMC function description

MLU-X1001 accelerator BMC management system main functions and features as follows:

Table 6.1 BMC Functional description

Function	Note
Remote control	Management through SOL functions
Information management	Management of equipment model, asset information and version information
Status monitoring	Real-time monitoring of power supply, temperature, working status and other operating states information
Heat dissipation control	Modulate fan speed according to environment temperature, equipment working load and abnormal conditions
Alarm management	Report the alarm information in real time and deal with it accordingly
WEB interface management	Provides visual WEB interface for query and management
IPMITool tool management	Support IPMITool

Note: Use button battery (Panasonic: CR2032) to power the RTC clock. If the battery is not replaced correctly, there is a risk of explosion.

7. Heat dissipation specifications

7.1 Description of the heat dissipation environment

The working environment of MLU-X1001 is as follows:

Table 7.1 Working environment of MLU-X1001

Items	Specification parameters
Working environment temperature	0~35°C
Relative humidity	20%~85% no condensation
Noise	62~88 dBA

Note: There will be 62~88dbA noise during normal operation. Please take adequate sound insulation measures in advance.

MLU-X1001 air volume description:

- MLU-X1001 can provide up to 360 CFM of air volume
- Do not block the front and rear ventilation areas of the chassis during operation of MLU-X1001
- When installing MLU-X1001, please reduce the air resistance around the inlet and outlet of the chassis
- Please follow the instructions to arrange the cable to minimize the air resistance of the air flue
- Please install the chassis cover before using MLU-X1001. If CXM1000 is used without the chassis cover, the components may be damaged.
- If you need to replace the fan, please make sure to complete within 25s to avoid overheating of the system.

7.2 Wind resistance curve of MLU-X1001

The system wind resistance curve of MLU-X1001 is shown below:

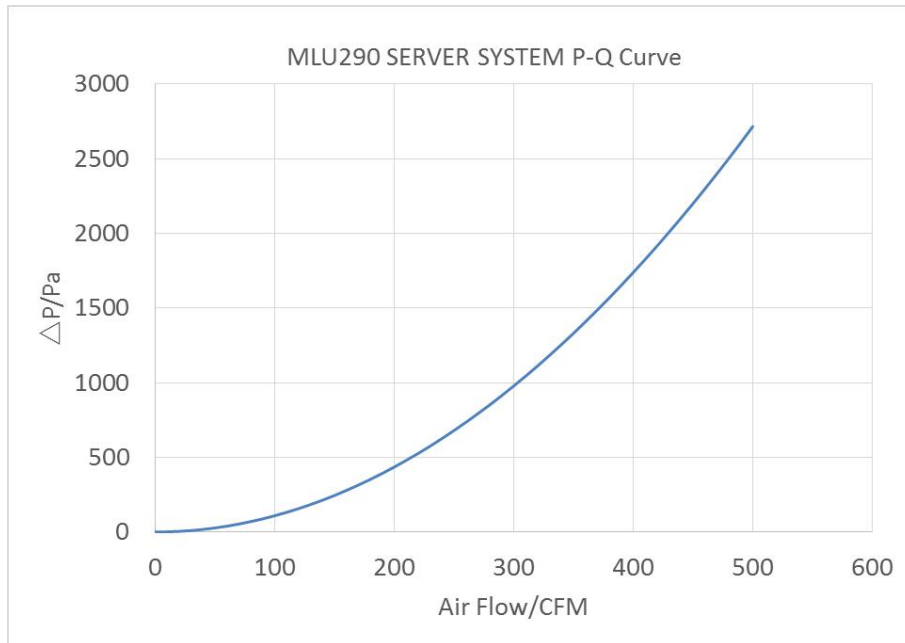

Figure 7.1 Wind resistance curve of MLU-X1001

Table 7.2 Air Volume VS Pressure Drop of MLU-X1001

Air volume (CFM)	Air pressure (Pa)
400	1737
360	1408
310	1044
260	735
0	0



8. Optional components

8.1 PCIE High Speed Cable

MLU-X1001 uses miniSAS HD high-speed cable for PCIE Gen4 interconnection. Compatible cable models are as follows:

Table 8.1 MLU-X1001 PCIE Compatible Cable

Manufacturers	Model	Specifications
Molex	2040431030	1 m ,30 AWG

8.2 MLU-LINK High Speed Cable

MLU-X1001 uses QSFP-DD high-speed cable for MLU-LINK interconnection. Compatible cable models are as follows:

Table 8.2 MLU-X1001 MLU-LINK Compatible Cable

Manufacturers	Model	Specifications
Molex	2015911012	1 m , 30 AWG
Molex	2015913020	2 m , 28 AWG
TE	2366016-4	1 m, 30 AWG
TE	2366101-3	2 m, 28 AWG

8.3 Network

MLU-X1001 can use InfiniBand network card or ROCE network card for cluster interconnection. Compatible network card models are as follows:

Table 8.3 Network Card Compatibility

Manufacturers	Model	Specifications
---------------	-------	----------------

Mellanox	MCX653105A-HDAT	Half high and half long single PCIE 4.0
----------	-----------------	--

8.4 Hard disk

Compatible NVMe hard disk models for MLU-X1001 are as follows:

Table 8.4 NVMe Hard Disk Compatibility

Manufacturers	Model	Specifications
HGST	HUSMR7619BHP301	NVMe 1.92Tb

Cambricon 寒 武 纪

9. Cambricon NeuWare development environment

NeuWare fully supports various mainstream programming frameworks (e.g. TensorFlow 、 Caffe 、 PyTorch and MXNet). For the above programming framework, users can easily develop and deploy deep learning applications on Cambrian MLU290-M5. At the same time, the NeuWare provides a complete runtime system and driver software to facilitate the rapid integration of the system.

NeuWare also provides a range of tools including application development, function debugging, performance tuning, etc. Among them, application development tools include machine learning library, runtime library, compiler, model retraining tool and specific field (such as video analysis field) SDK; function debugging tools can meet different levels of debugging requirements such as programming framework and function library; performance tuning tools include performance profiling tools and system monitoring tools.

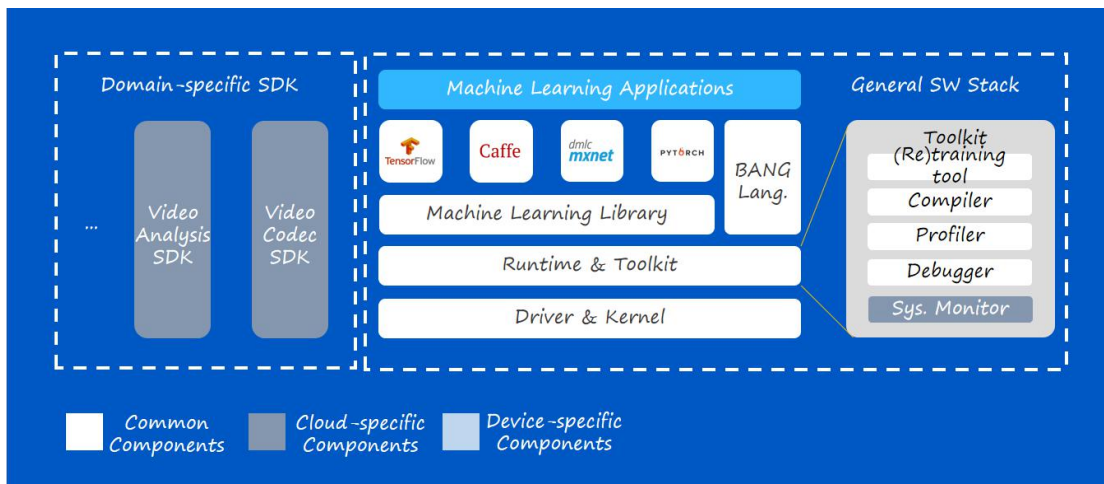

Figure 9.1 Cambricon NeuWare



10. Compliance

MLU-X1001 accelerator is compliant with the regulations listed in this chapter. The compliance marks can be found on the labels of each devices.

FCC statement

This device complies with Part 15 of the FCC Rules.

Operation is subject to the following two conditions: (1) This device may not cause harmful interference, and (2) this device must accept any interference received, including interference that may cause undesired operation.

This equipment has been tested and found to comply with the limits for a Class A digital device, pursuant to part 15 of the FCC Rules. These limits are designed to provide reasonable protection against harmful interference when the equipment is operated in a commercial environment. This equipment generates, uses, and can radiate radio frequency energy and, if not installed and used in accordance with the instruction manual, may cause harmful interference to radio communications. Operation of this equipment in a residential area is likely to cause harmful interference in which case the user will be required to correct the interference at his own expense.

Caution: Any changes or modifications not expressly approved by the party responsible for compliance could void the user's authority to operate this equipment.

Underwriters Laboratories (UL)

UL Listed Product Logo for MLU-X1001 Accelerator, model name MLU-X1001.

