

Test Report

FCC ID: 2ARUK-MAX2

Date of issue: Jan. 11, 2019

Report Number:	MTi181225E146
Sample Description:	LOVENSE Max 2
Model(s):	Max 2
Applicant:	Hytto Limited
Address:	12/F, AT Tower, 180 Electric Rd. North Point, Hongkong
Date of Test:	Dec. 21, 2018 – Jan. 11, 2019

Shenzhen Microtest Co., Ltd.
<http://www.mtitest.com>

Table of Contents

1. GENERAL INFORMATION	5
1.1. DESCRIPTION OF EUT	5
1.2. OPERATION CHANNEL LIST	5
1.3. TEST CHANNEL LIST	6
1.4. ANCILLARY EQUIPMENT LIST	6
1.5. DESCRIPTION OF SUPPORT UNITS	6
2. SUMMARY OF TEST RESULTS.....	7
3. TEST FACILITIES AND ACCREDITATIONS.....	8
3.1. TEST LABORATORY	8
3.2. ENVIRONMENTAL CONDITIONS	8
3.3. MEASUREMENT UNCERTAINTY	8
3.4. TEST SOFTWARE	8
4. EQUIPMENT LIST	9
5. TEST RESULT	10
5.1. ANTENNA REQUIREMENT	10
5.1.1 <i>Standard requirement</i>	10
5.1.2 <i>EUT Antenna</i>	10
5.2. PEAK OUTPUT POWER TEST	11
5.2.1 <i>Limit</i>	11
5.2.2 <i>Test setup</i>	11
5.2.3 <i>Test procedure</i>	11
5.2.4 <i>EUT operation condition</i>	11
5.2.5 <i>Test results</i>	11
5.3. CONDUCTED EMISSION	15
5.3.1 <i>Limits</i>	15
5.3.2 <i>Test setup</i>	15
5.3.3 <i>Test procedure</i>	16
5.3.4 <i>Test results</i>	16
5.4. RADIATED SPURIOUS EMISSION.....	21
5.4.1 <i>Limits</i>	21
5.4.2 <i>Test setup</i>	22
5.4.3 <i>Test procedure</i>	23
5.4.4 <i>Test results</i>	24
5.4.4.1 <i>Radiation emission</i>	24
5.4.4.2 <i>Bandedge-radiated</i>	28
5.4.4.3 <i>Spurious Emission in Restricted Band 3260MMHz-18000MHz</i>	29
5.5. POWER SPECTRAL DENSITY TEST	30
5.5.1 <i>Limit</i>	30
5.5.2 <i>Test procedure</i>	30
5.5.3 <i>Test setup</i>	30
5.5.4 <i>EUT operation conditions</i>	30
5.5.5 <i>Test results</i>	31
5.6. 6DB BANDWIDTH	33
5.6.1 <i>Limit</i>	33
5.6.2 <i>TEST PROCEDURE</i>	33
5.6.3 <i>TEST SETUP</i>	33
5.6.4 <i>EUT operation conditions</i>	33
5.6.5 <i>Test Result</i>	33
5.7. CONDUCTED BANDEDGE	36
5.7.1 <i>Limits</i>	36
5.7.2 <i>Test setup</i>	36

5.7.3	Test procedure.....	36
5.7.4	EUT operation conditions.....	36
5.7.5	Test Result	36
5.8	SPURIOUS RF CONDUCTED EMISSIONS	38
5.8.1	Conformance Limit.....	38
5.8.2	Measuring Instruments.....	38
5.8.3	Test Setup.....	38
5.8.4	Test Procedure.....	38
5.8.5	Test Results.....	38
PHOTOGRAPHS OF THE TEST SETUP		40
PHOTOGRAPHS OF THE EUT		42

PRODUCT INFORMATION

Applicant's name: Hytto Limited

Address: 12/F, AT Tower, 180 Electric Rd. North Point, Hongkong

Manufacture's Name: Shenzhen Love Sense Technology Co., Ltd.

Address: Room 13, 2nd floor Pingshan Industrial Zone, Pingshan 1st Rd, Taoyuan St, Nanshan, Shenzhen, Guangdong, China, 518055

Product name: LOVENSE Max 2

Trademark: LOVENSE

Model name: Max 2

Standards: FCC Part 15.247
ANSI C63.10:2013

Test Procedure: KDB 558074 D01 DTS Meas Guidance v05
KDB 174176 D01 Line Conducted FAQ v01r01

This device described above has been tested by Shenzhen Microtest Co., Ltd and the test results show that the equipment under test (EUT) is in compliance with the FCC requirements. And it is applicable only to the tested sample identified in the report.

Tested by:



Orange Chen

Jan. 11, 2019

Reviewed by:



Blue Zheng

Jan. 11, 2019

Approved by:



Smith Chen

Jan. 11, 2019

1. General Information

1.1. Description of EUT

Product name:	LOVENSE Max 2
Model name:	Max 2
Serial model:	N/A
Difference in series models:	N/A
Operation frequency:	2402-2480MHz
Modulation type:	GFSK
Bit Rate of transmitter:	1 Mbps
Antenna type:	PCB Antenna
Antenna gain:	3dBi
Max. output power:	-0.133 dBm
Hardware version:	V1.06
Software version:	B201
Power supply:	DC 3.7V from battery
Adapter information:	N/A
Battery:	DC 3.7V 650mAh

1.2. Operation channel list

Channel No.	Frequency (MHz)	Channel No.	Frequency (MHz)	Channel No.	Frequency (MHz)	Channel No.	Frequency (MHz)
0	2402	10	2422	20	2442	30	2462
1	2404	11	2424	21	2444	31	2464
2	2406	12	2426	22	2446	32	2466
3	2408	13	2428	23	2448	33	2468
4	2410	14	2430	24	2450	34	2470
5	2412	15	2432	25	2452	35	2472
6	2414	16	2434	26	2454	36	2474
7	2416	17	2436	27	2456	37	2476
8	2418	18	2438	28	2458	38	2478
9	2420	19	2440	29	2460	39	2480

1.3. Test channel list

Channel	Channel	Frequency (MHz)
Low	00	2402
Middle	19	2440
High	39	2480

1.4. Ancillary equipment list

Equipment	Model	S/N	Manufacturer	Certificate type
Adapter	MEIZU	/	/	/

1.5. Description of Support Units

The EUT has been tested as an independent unit together with other necessary accessories or support units. The following support units or accessories were used to form a representative test configuration during the tests.

Item	Equipment	Brand	Model/Type No.	Series No.	Note
/	/	/	/	/	
/	/	/	/	/	

Note:

(1)The support equipment was authorized by Declaration of Confirmation.

(2)For detachable type I/O cable should be specified the length in cm in 『Length』 column.

2. Summary of Test Results

Test procedures according to the technical standards:

No.	Standard Section	Test Item	Result	Remark
1	15.207	Conducted Emission	Pass	
2	15.247 (a)(2)	6dB Bandwidth	Pass	
3	15.247 (b)	Peak Output Power	Pass	
4	15.247 (d) & 15.209	Radiated Spurious Emission	Pass	
5	15.247 (e)	Power Spectral Density	Pass	
6	15.205	Band Edge Emission	Pass	
7	15.203	Antenna Requirement	Pass	
8	15.205	Spurious RF Conducted Emissions	Pass	

3. Test Facilities and Accreditations

3.1. Test laboratory

Test Laboratory	Shenzhen Microtest Co., Ltd
Location	No.102A & 302A, East Block, Hengfang Industrial Park, Xingye Road, Xixiang, Bao'an District, Shenzhen, Guangdong, China
FCC Registration No.:	448573

3.2. Environmental conditions

Temperature:	15°C~30°C
Humidity	30%~70%
Atmospheric pressure	98kPa~101kPa

3.3. Measurement uncertainty

The reported uncertainty of measurement $y \pm U$ where expanded uncertainty U is based on a standard uncertainty multiplied by a coverage factor of $k=2$ providing a level of confidence of approximately 95 %

No.	Item	Uncertainty
1	Conducted Emission Test	$\pm 1.38\text{dB}$
2	RF power, conducted	$\pm 0.16\text{dB}$
3	Spurious emissions, conducted	$\pm 0.21\text{dB}$
4	All emissions, radiated(<1G)	$\pm 4.68\text{dB}$
5	All emissions, radiated(>1G)	$\pm 4.89\text{dB}$
6	Temperature	$\pm 0.5^\circ\text{C}$
7	Humidity	$\pm 2\%$

3.4. Test software

Software Name	Manufacturer	Model	Version
RF Test System	Farad	LZ-RF	Lz_Rf 3A3

4. Equipment list

Equipment No.	Equipment Name	Manufacturer	Model	Serial No.	Calibration date	Due date
MTI-E001	Spectrum Analyzer	Agilent	E4407B	MY41441082	2018/09/18	2019/09/17
MTI-E002	CMU 200 universal radio communication tester	Rohde&schwarz	CMU 200	114587	2018/09/18	2019/09/17
MTI-E004	EMI Test Receiver	Rohde&schwarz	ESPI	1000314	2018/09/18	2019/09/17
MTI-E006	Broadband antenna	schwarzbeck	VULB9163	872	2018/09/18	2019/09/17
MTI-E007	Horn antenna	schwarzbeck	BBHA9120D	1201	2018/09/18	2019/09/17
MTI-E014	amplifier	America	8447D	3113A06150	2018/09/18	2019/09/17
MTI-E015	Conduction Immunity Signal Generator	Schloder	CDG6000	126A1343/2015	2018/09/18	2019/09/17
MTI-E016	Coupled decoupling network	Schloder	CDA M2/M3	A2210332/2015	2018/09/18	2019/09/17
MTI-E032	Comprehensive test instrument	Rohde&schwarz	CMW500	124192	2018/09/18	2019/09/17
MTI-E034	amplifier	Agilent	8449B	3008A02400	2018/09/18	2019/09/17
MTI-E037	Artificial power network	Schwarzbeck	NSLK8127	#841	2018/09/18	2019/09/17
MTI-E040	Spectrum analyzer	Agilent	N9020A	MY49100060	2018/09/18	2019/09/17
MTI-E041	Signal generator	Agilent	N5182A	MY49060455	2018/09/18	2019/09/17
MTI-E042	Analog signal generator	Agilent	E4421B	GB40051240	2018/09/18	2019/09/17
MTI-E043	Power sensor	Dare Instruments	RPR3006W	16100054SN016	2018/09/18	2019/09/17
MTI-E047	10dB attenuator	Mini-Circuits	UNAT-10+	15542	2018/09/18	2019/09/17
MTI-E049	spectrum analyzer	Rohde&schwarz	FSP-38	100019	2018/09/18	2019/09/17
MTI-E050	PSG Signal generator	Agilent	E8257D	MY46520873	2018/09/18	2019/09/17
MTI-E051	Active Loop Antenna 9kHz - 30MHz	Schwarzbeck	FMZB 1519 B	00044	2018/09/18	2019/09/17
MTI-E052	18-40GHz amplifier	Chengdu step Micro Technology	ZLNA-18-40G-21	1608001	2018/09/18	2019/09/17
MTI-E053	15-40G Antenna	Schwarzbeck	BBHA9170	BBHA9170582	2018/09/18	2019/09/17
MTI-E058	Artificial power network	Schwarzbeck	NSLK8127	#841	2018/09/18	2019/09/17

Note: the calibration interval of the above test instruments is 12 months and the calibrations are traceable to international system unit (SI).

5. Test Result

5.1. Antenna requirement

5.1.1 Standard requirement

15.203 requirement: For intentional device, according to 15.203: an intentional radiator shall be designed to ensure that no antenna other than that furnished by the responsible party shall be used with the device

5.1.2 EUT Antenna

The EUT antenna is PCB antenna (3dBi). It comply with the standard requirement. In case of replacement of broken antenna the same antenna type must be used.

5.2. Peak output power test

5.2.1 Limit

FCC Part15 Subpart C			
Section	Test Item	Limit	Frequency Range (MHz)
15.247(b)(3)	Peak output power	1 watt or 30dBm	2400-2483.5

5.2.2 Test setup



5.2.3 Test procedure

- (1) The EUT was directly connected to the spectrum analyzer and antenna output port as show in the block diagram above.
- (2) Spectrum Setting:
RBW=1MHz, VBW=3MHz, Detector=Peak (If 20dB BW ≤ 1 MHz)
RBW=3MHz, VBW=10MHz, Detector=Peak (If 20dB BW > 1 MHz)
- (3) The EUT was set to continuously transmitting in the max power during the test.

5.2.4 EUT operation condition

The EUT tested system was configured as the statements of 2.4 Unless otherwise a special operating condition is specified in the follows during the testing.

5.2.5 Test results

EUT :	LOVENSE Max 2	Model Name :	Max 2
Temperature :	25 °C	Relative Humidity :	60%
Pressure :	1012 hPa	Test Voltage :	DC 3.7V from battery

TX BLE mode

Test Channe	Frequency	Maximum Conducted Output Power(PK)	Limit
	(MHz)	(dBm)	dBm
CH00	2402	-0.338	30
CH19	2440	-0.133	30
CH39	2480	-0.576	30

///

2402MHz

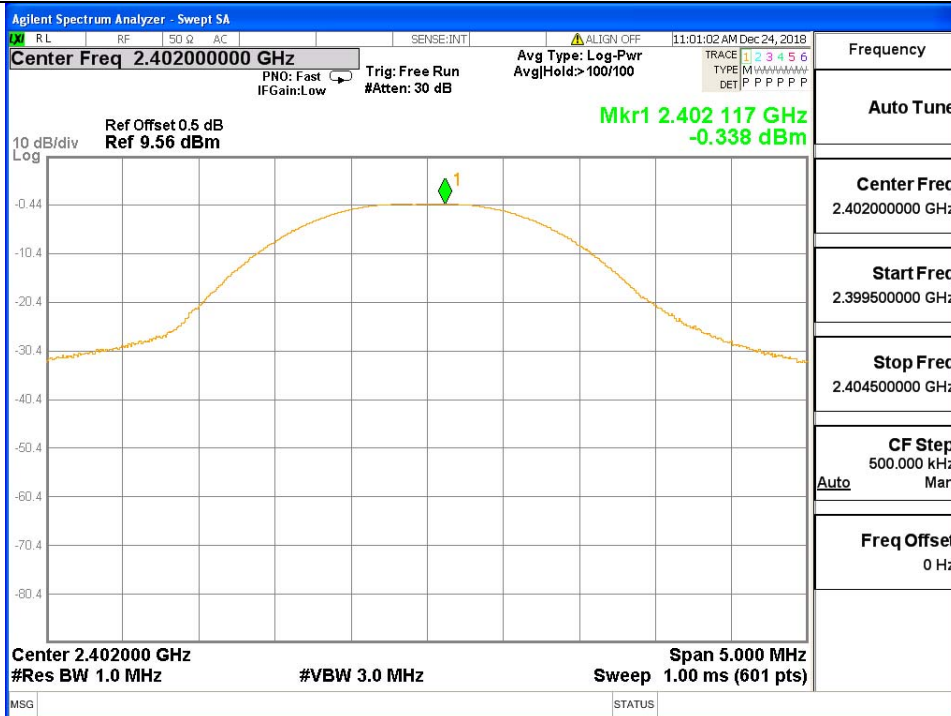

2440MHz

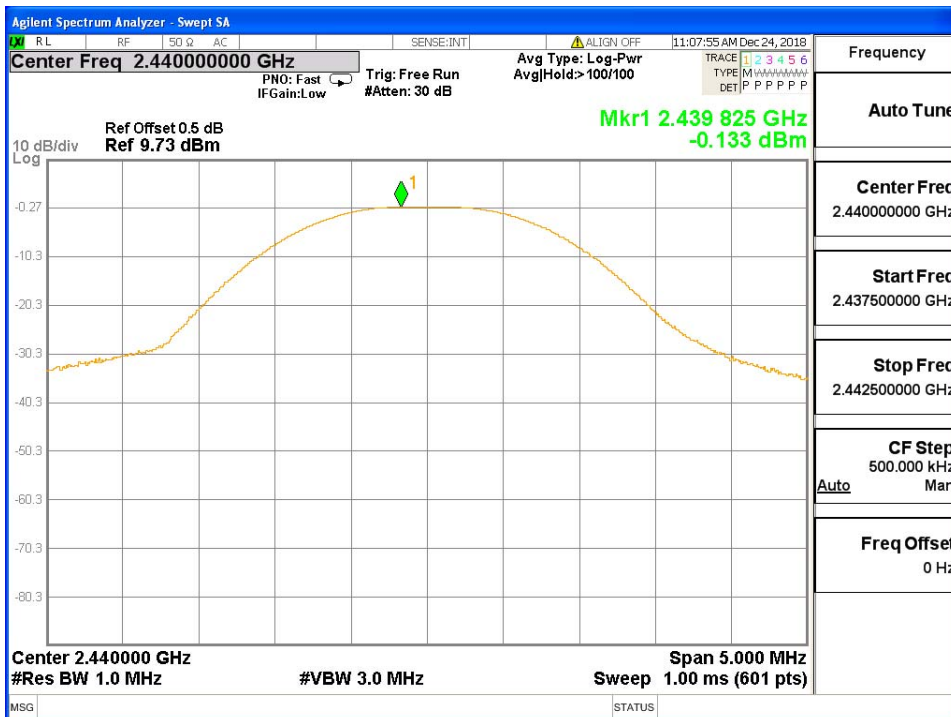

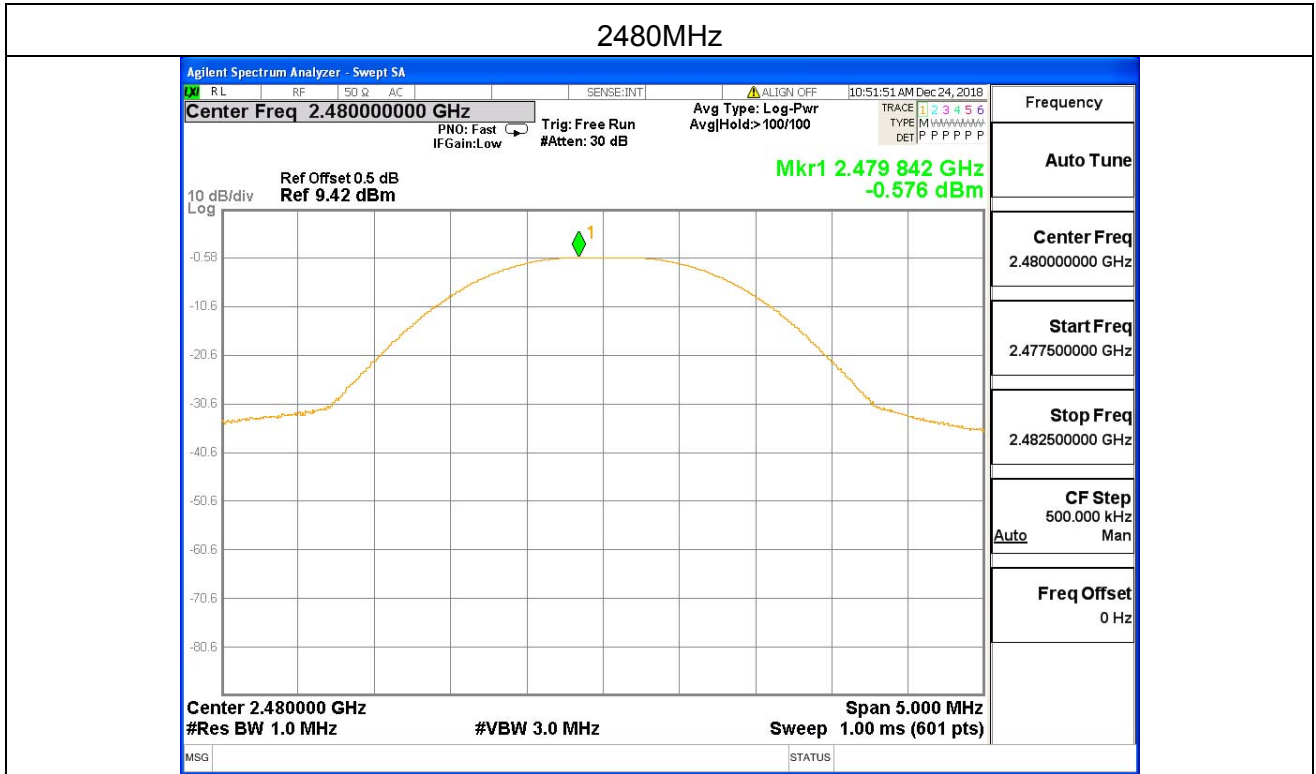

5.3. Conducted emission

5.3.1 Limits

FREQUENCY (MHz)	Class B (dBuV)	
	Quasi-peak	Average
0.15 -0.5	66 - 56 *	56 - 46 *
0.50 -5.0	56.00	46.00
5.0 -30.0	60.00	50.00

Note

(1)The tighter limit applies at the band edges.

(2)The limit of " * " marked band means the limitation decreases linearly with the logarithm of the frequency in the range.

5.3.2 Test setup

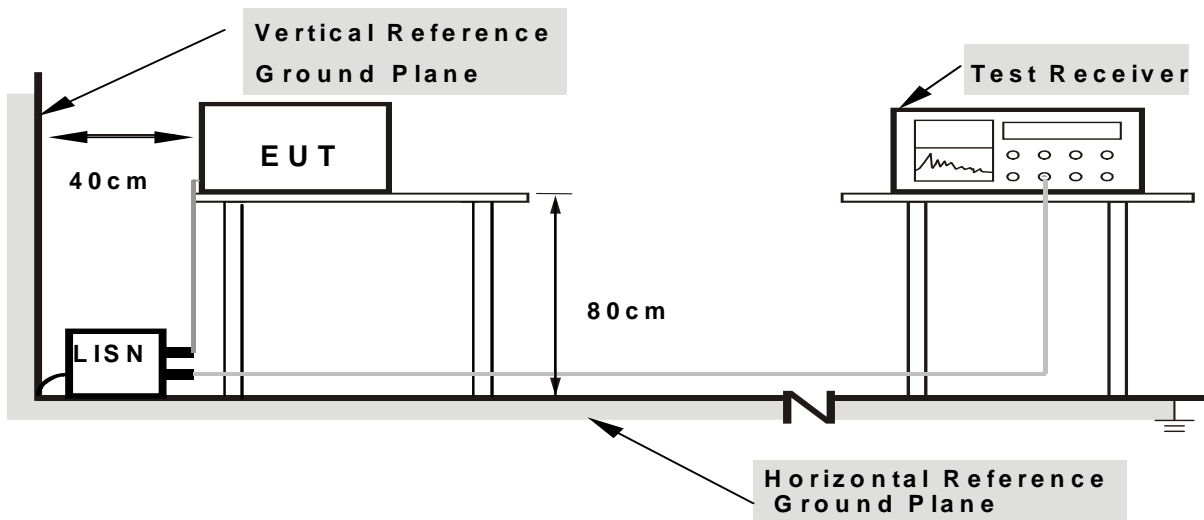

Note: 1.Support units were connected to second LISN .

2.Both of LISNs (AMN) are 80 cm from EUT and at least 80 from other units and other metal planes

5.3.3 Test procedure

a. EUT Operating Conditions

The EUT was configured for testing in a typical fashion (as a customer would normally use it). The EUT has been programmed to continuously transmit during test. This operating condition was tested and used to collect the included data.

b. The following table is the setting of the receiver

Receiver Parameters	Setting
Attenuation	10 dB
Start Frequency	0.15 MHz
Stop Frequency	30 MHz
IF Bandwidth	9 kHz

- c. The EUT was placed 0.8 meters from the horizontal ground plane with EUT being connected to the power mains through a line impedance stabilization network (LISN). All other support equipments powered from additional LISN(s). The LISN provide 50 Ohm/ 50uH of coupling impedance for the measuring instrument.
- d. Interconnecting cables that hang closer than 40 cm to the ground plane shall be folded back and forth in the center forming a bundle 30 to 40 cm long.
- e. I/O cables that are not connected to a peripheral shall be bundled in the center. The end of the cable may be terminated, if required, using the correct terminating impedance. The overall length shall not exceed 1 m.
- f. LISN at least 80 cm from nearest part of EUT chassis.

For the actual test configuration, please refer to the related Item –EUT Test Photos.

5.3.4 Test results

Test data

EUT :	LOVENSE Max 2	Model Name. :	Max 2
Temperature :	26 °C	Relative Humidity :	54%
Pressure :	1010hPa	Phase :	L
Test Voltage :	DC 5V from adapter AC 120V/60Hz	Test Mode :	Normal link

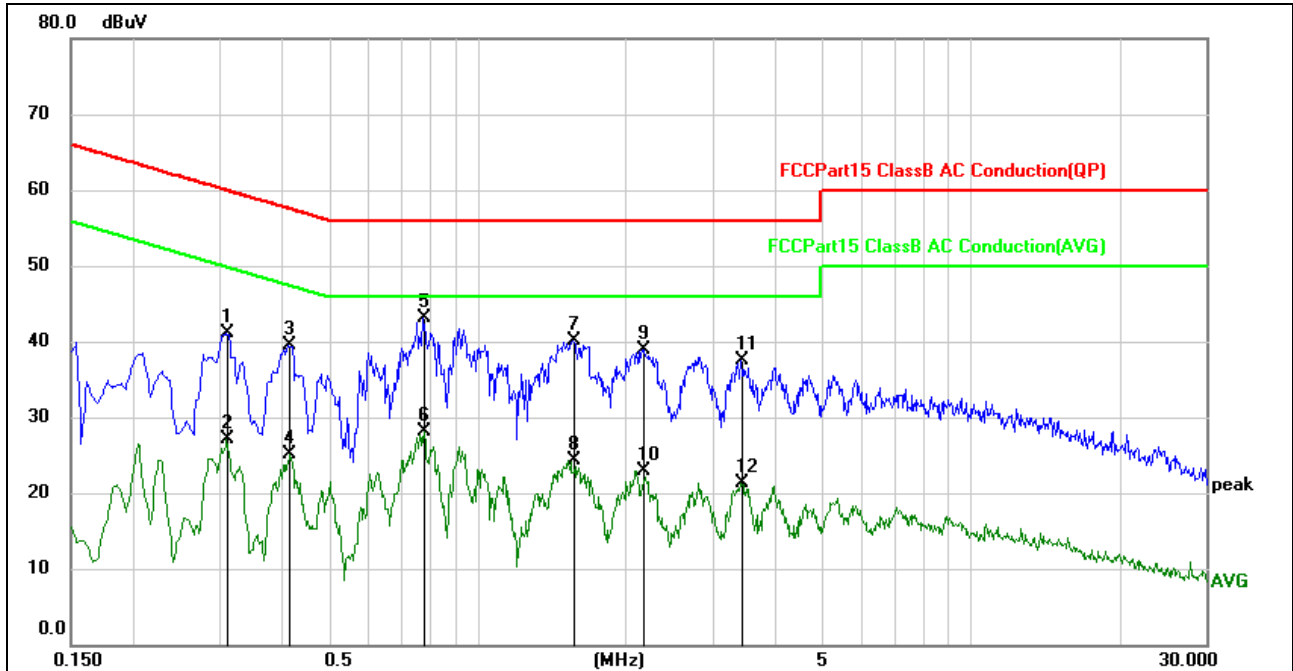

No.	Mk.	Freq. MHz	Reading Level dBuV	Correct Factor dB	Measure- ment dBuV	Limit dBuV	Over dB	Detector	Comment
1		0.3100	39.45	1.57	41.02	59.97	-18.95	QP	
2		0.3100	25.61	1.57	27.18	49.97	-22.79	AVG	
3		0.4140	37.85	1.57	39.42	57.57	-18.15	QP	
4		0.4140	23.48	1.57	25.05	47.57	-22.52	AVG	
5	*	0.7780	41.62	1.57	43.19	56.00	-12.81	QP	
6		0.7780	26.49	1.57	28.06	46.00	-17.94	AVG	
7		1.5660	38.60	1.58	40.18	56.00	-15.82	QP	
8		1.5660	22.74	1.58	24.32	46.00	-21.68	AVG	
9		2.1660	37.43	1.47	38.90	56.00	-17.10	QP	
10		2.1660	21.39	1.47	22.86	46.00	-23.14	AVG	
11		3.4300	36.50	0.96	37.46	56.00	-18.54	QP	
12		3.4300	20.34	0.96	21.30	46.00	-24.70	AVG	

EUT :	LOVENSE Max 2	Model Name. :	Max 2
Temperature :	26 °C	Relative Humidity :	54%
Pressure :	1010hPa	Phase :	N
Test Voltage :	DC 5V from adapter AC 120V/60Hz	Test Mode :	Normal link

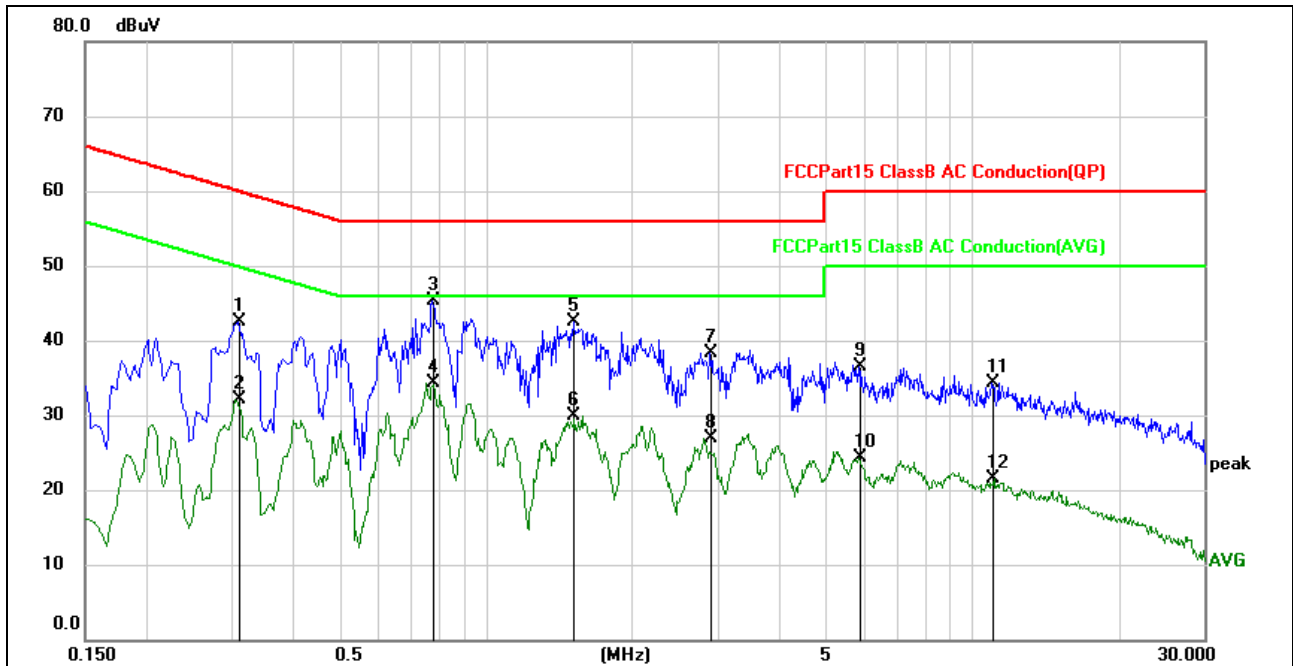

No.	Mk.	Freq. MHz	Reading Level dBuV	Correct Factor dB	Measure- ment dBuV	Limit dBuV	Over dB	Detector	Comment
1		0.3100	40.98	1.57	42.55	59.97	-17.42	QP	
2		0.3100	30.56	1.57	32.13	49.97	-17.84	AVG	
3	*	0.7780	43.68	1.57	45.25	56.00	-10.75	QP	
4		0.7780	32.79	1.57	34.36	46.00	-11.64	AVG	
5		1.5140	40.92	1.58	42.50	56.00	-13.50	QP	
6		1.5140	28.26	1.58	29.84	46.00	-16.16	AVG	
7		2.8940	37.32	1.07	38.39	56.00	-17.61	QP	
8		2.8940	25.86	1.07	26.93	46.00	-19.07	AVG	
9		5.8420	36.10	0.35	36.45	60.00	-23.55	QP	
10		5.8420	23.97	0.35	24.32	50.00	-25.68	AVG	
11		10.9700	33.99	0.37	34.36	60.00	-25.64	QP	
12		10.9700	21.10	0.37	21.47	50.00	-28.53	AVG	

EUT :	LOVENSE Max 2	Model Name. :	Max 2
Temperature :	26 °C	Relative Humidity :	54%
Pressure :	1010hPa	Phase :	L
Test Voltage :	DC 5V from adapter AC 240V/60Hz	Test Mode :	Normal link

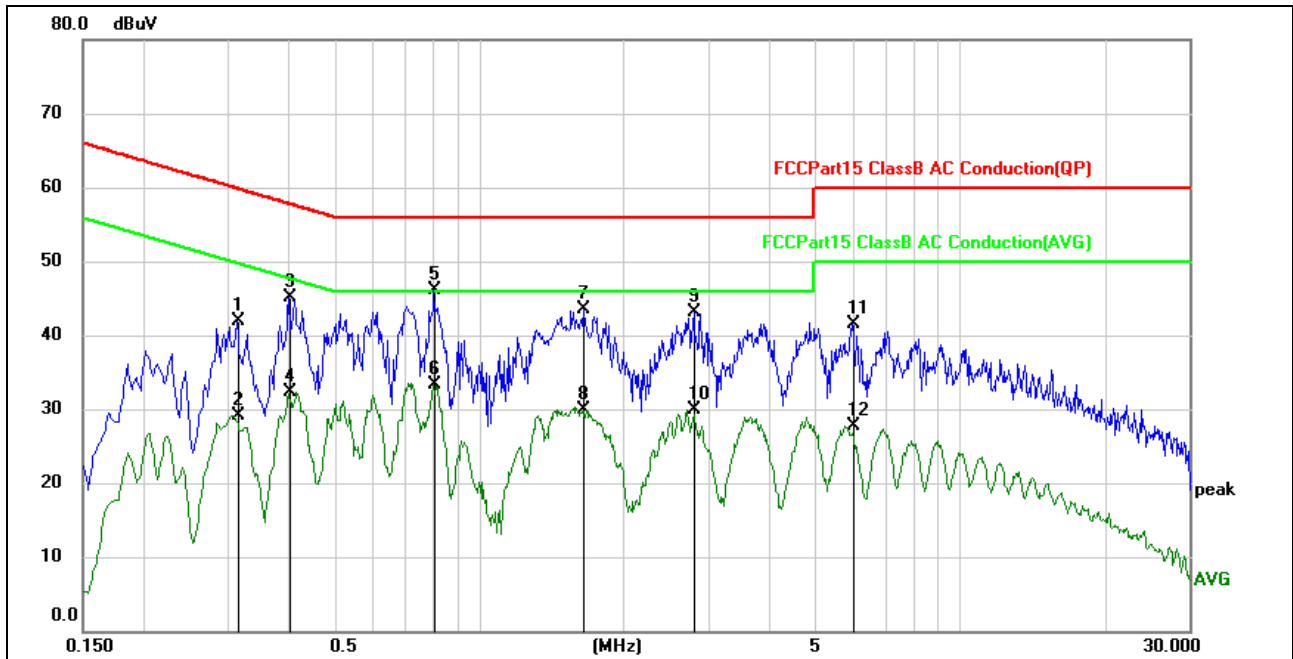

No.	Mk.	Freq.	Reading Level	Correct Factor	Measurement	Limit	Over	Detector	Comment
		MHz	dBuV	dB	dBuV	dBuV	dB		
1		0.3140	41.93	0.02	41.95	59.86	-17.91	QP	
2		0.3140	29.03	0.02	29.05	49.86	-20.81	AVG	
3		0.4020	45.00	0.02	45.02	57.81	-12.79	QP	
4		0.4020	32.33	0.02	32.35	47.81	-15.46	AVG	
5	*	0.8059	46.05	0.02	46.07	56.00	-9.93	QP	
6		0.8059	33.30	0.02	33.32	46.00	-12.68	AVG	
7		1.6500	43.50	0.02	43.52	56.00	-12.48	QP	
8		1.6500	29.85	0.02	29.87	46.00	-16.13	AVG	
9		2.8020	43.00	0.04	43.04	56.00	-12.96	QP	
10		2.8020	29.82	0.04	29.86	46.00	-16.14	AVG	
11		5.9699	41.44	0.06	41.50	60.00	-18.50	QP	
12		5.9699	27.61	0.06	27.67	50.00	-22.33	AVG	

EUT :	LOVENSE Max 2	Model Name. :	Max 2
Temperature :	26 °C	Relative Humidity :	54%
Pressure :	1010hPa	Phase :	N
Test Voltage :	DC 5V from adapter AC 240V/60Hz	Test Mode :	Normal link

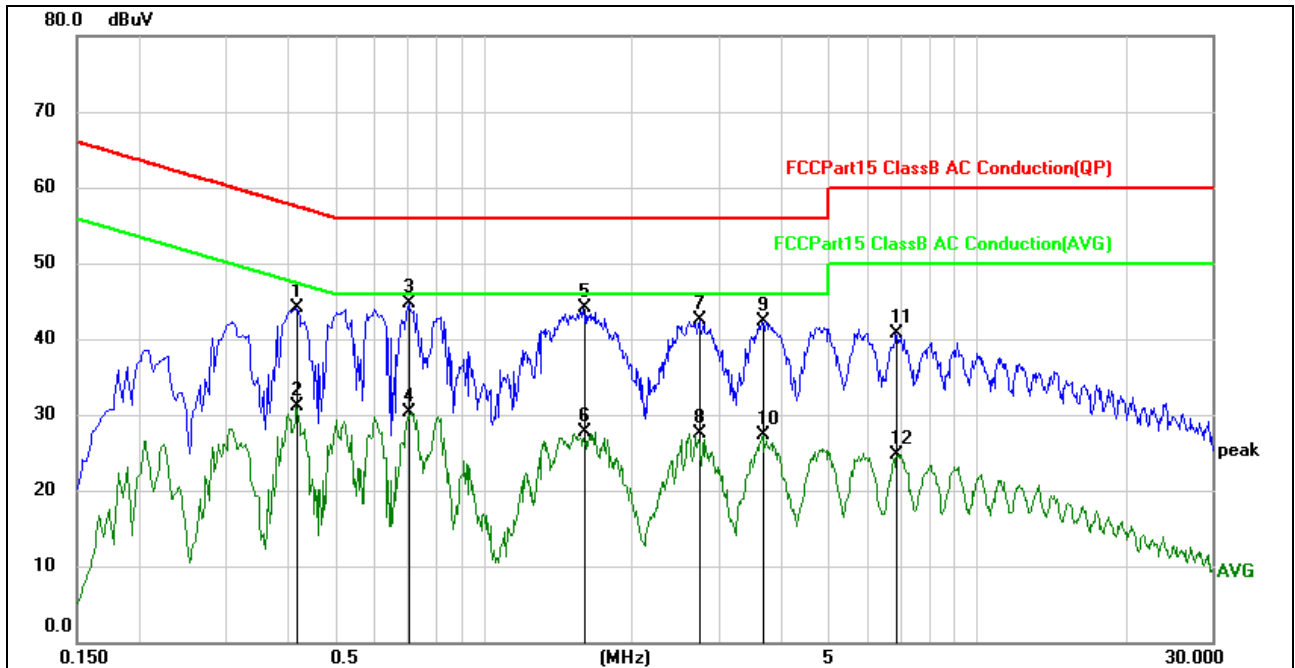

No.	Mk.	Freq. MHz	Reading Level dBuV	Correct Factor dB	Measure- ment dBuV	Limit dBuV	Over dB	Detector	Comment
1		0.4180	43.99	0.02	44.01	57.49	-13.48	QP	
2		0.4180	31.00	0.02	31.02	47.49	-16.47	AVG	
3	*	0.7060	44.67	0.02	44.69	56.00	-11.31	QP	
4		0.7060	30.24	0.02	30.26	46.00	-15.74	AVG	
5		1.5980	44.04	0.02	44.06	56.00	-11.94	QP	
6		1.5980	27.72	0.02	27.74	46.00	-18.26	AVG	
7		2.7380	42.38	0.03	42.41	56.00	-13.59	QP	
8		2.7380	27.45	0.03	27.48	46.00	-18.52	AVG	
9		3.6660	42.31	0.04	42.35	56.00	-13.65	QP	
10		3.6660	27.35	0.04	27.39	46.00	-18.61	AVG	
11		6.8540	40.59	0.09	40.68	60.00	-19.32	QP	
12		6.8540	24.60	0.09	24.69	50.00	-25.31	AVG	

5.4 Radiated spurious emission

5.4.1 Limits

Frequency (MHz)	Field Strength (micorvolts/meter)	Measurement Distance (meters)
0.009~0.490	2400/F(KHz)	300
0.490~1.705	24000/F(KHz)	30
1.705~30.0	30	30
30~88	100	3
88~216	150	3
216~960	200	3
Above 960	500	3

Spectrum Parameter	Setting
Attenuation	Auto
Start Frequency	1000 MHz
Stop Frequency	10th carrier harmonic
RB / VB (emission in restricted band)	1 MHz / 1 MHz for Peak, 1 MHz / 10Hz for Average

Receiver Parameter	Setting
Attenuation	Auto
Start ~ Stop Frequency	9kHz~150kHz / RB 200Hz for QP
Start ~ Stop Frequency	150kHz~30MHz / RB 9kHz for QP
Start ~ Stop Frequency	30MHz~1000MHz / RB 120kHz for QP

5.4.2 Test setup

Radiated emission test-up frequency below 30MHz

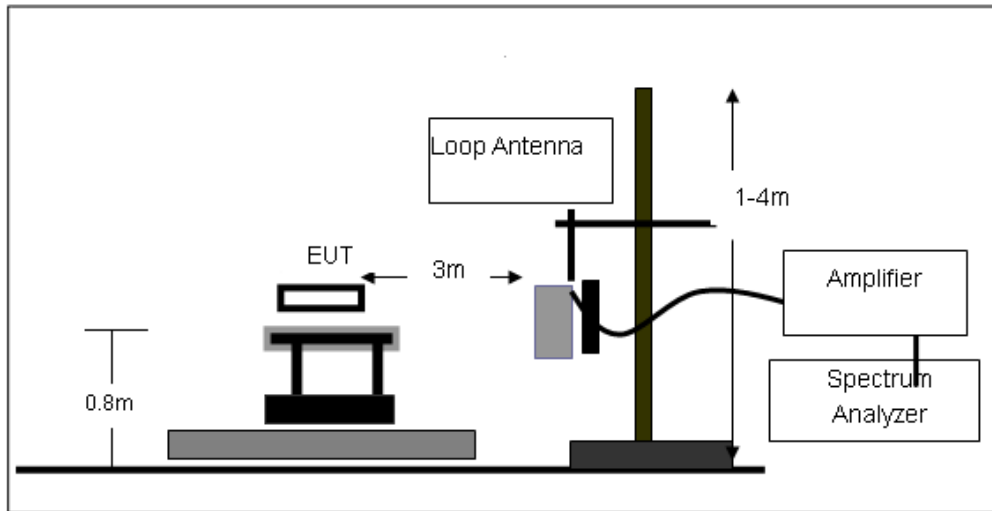

Radiated emission test-up frequency 30MHz~1GHz

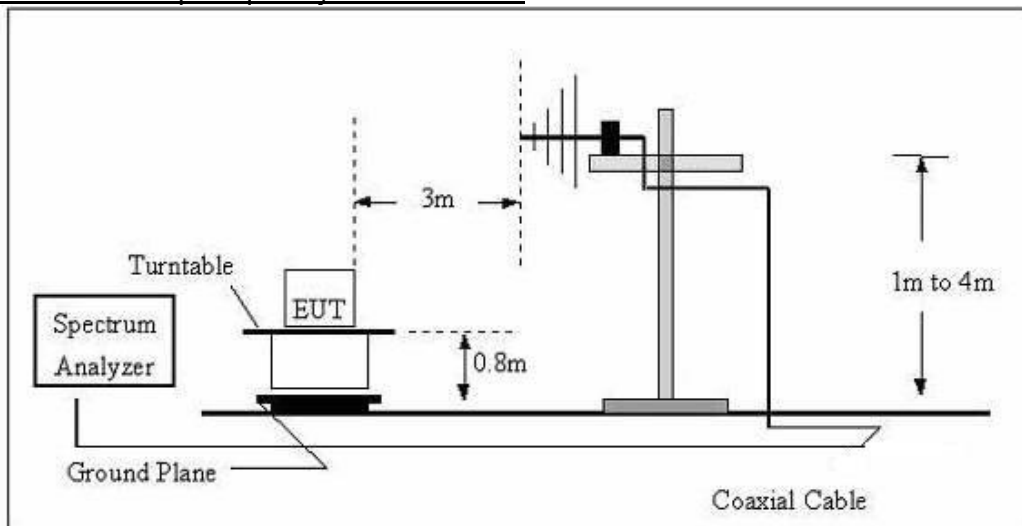

Radiated emission test-up frequency above 1GHz

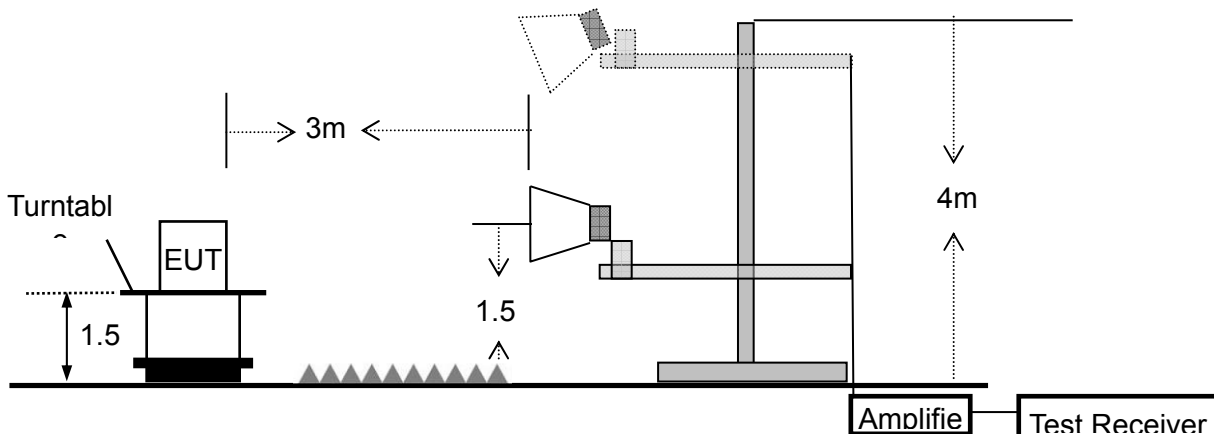

5.4.3 Test procedure

- a. EUT operating conditions. The EUT tested system was configured as the statements of 2.4 Unless otherwise a special operating condition is specified in the follows during the testing.
- b. The measuring distance of at 3 m shall be used for measurements at frequency up to 1GHz. For frequencies above 1GHz, any suitable measuring distance may be used.
- c. The EUT was placed on the top of a rotating table 0.8 meters above the ground at a 3 meter shield area test site. The table was rotated 360 degrees to determine the position of the highest radiation.
- d. The height of the equipment or of the substitution antenna shall be 0.8 m; the height of the test antenna shall vary between 1 m to 4 m. Both horizontal and vertical polarizations of the antenna are set to make the measurement.
- e. The initial step in collecting conducted emission data is a spectrum analyzer peak detector mode pre-scanning the measurement frequency range. Significant peaks are then marked and then Quasi Peak detector mode re-measured.
- f. If the Peak Mode measured value compliance with and lower than Quasi Peak Mode Limit, the EUT shall be deemed to meet QP Limits and then no additional QP Mode measurement performed.
- g. For the actual test configuration, please refer to the related Item –EUT Test photos.

Note: Both horizontal and vertical antenna polarities were tested and performed pretest to three orthogonal axis. The worst case emissions were reported.

During the radiated emission test, the Spectrum Analyzer was set with the following configurations:

Frequency Band (MHz)	Function	Resolution bandwidth	Video Bandwidth
30 to 1000	QP	120 kHz	300 kHz
Above 1000	Peak	1 MHz	1 MHz
	Average	1 MHz	10 Hz

Note: for the frequency ranges below 30 MHz, a narrower RBW is used for these ranges but the measured value should add a RBW correction factor (RBWCF) where $RBWCF [dB] = 10 \cdot \lg(100 [kHz] / \text{narrower RBW [kHz]})$. , the narrower RBW is 1 kHz and RBWCF is 20 dB for the frequency 9 kHz to 150 kHz, and the narrower RBW is 10 kHz and RBWCF is 10 dB for the frequency 150 kHz to 30 MHz.

5.4.4 Test results

5.4.4.1 Radiation emission

Below 30MHz

EUT:	LOVENSE Max 2	Model Name. :	Max 2
Temperature:	20 °C	Relative Humidity:	48%
Pressure:	1010 hPa	Test Voltage:	DC 5V from adapter
Test Mode:	TX+Charging	Polarization :	--

Freq.	Reading	Limit	Margin	State
(MHz)	(dBuV/m)	(dBuV/m)	(dB)	P/F
--	--	--	--	Pass
--	--	--	--	Pass

Note:

The amplitude of spurious emissions which are attenuated by more than 20dB below the permissible value has no need to be reported.

Distance extrapolation factor = $40 \log(\text{specific distance}/\text{test distance})$ (dB);

Limit line = specific limits(dBuV) + distance extrapolation factor.

Between 30MHz – 1GHz:

Note: The three modulated high, medium and low channels have been tested. The report only shows the worst mode. The worst mode is GFSK CH19

EUT :	LOVENSE Max 2	Model Name. :	Max 2
Relative Humidity:	52%	Phase:	H
Pressure:	1010 hPa	Test Voltage :	DC 5V from adapter
Test Mode :	TX+Charging		

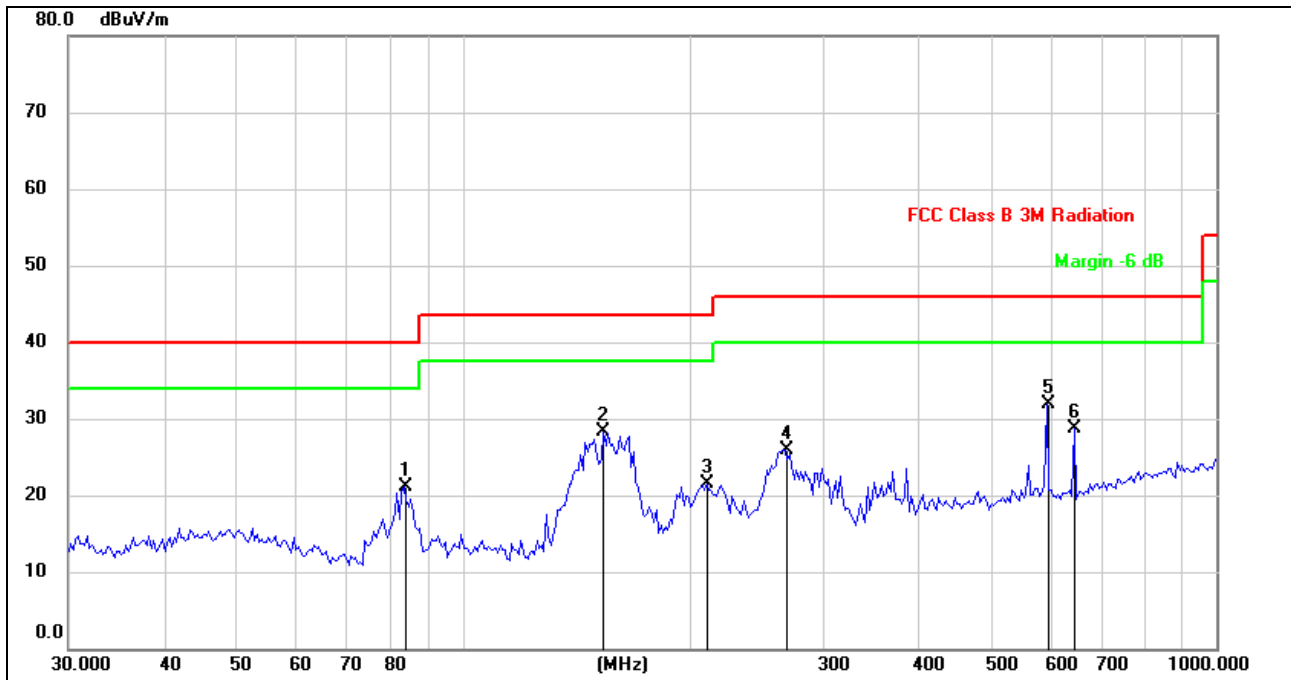

No.	Mk.	Freq. MHz	Reading Level dBuV	Correct Factor dBuV/m	Measure- ment dBuV/m	Limit dBuV/m	Over dB	Detector
1		83.5222	35.75	-14.66	21.09	40.00	-18.91	QP
2		153.7385	42.72	-14.32	28.40	43.50	-15.10	QP
3		210.7860	32.90	-11.36	21.54	43.50	-21.96	QP
4		267.5455	35.49	-9.53	25.96	46.00	-20.04	QP
5	*	595.1329	37.16	-5.32	31.84	46.00	-14.16	QP
6		647.3856	33.56	-4.81	28.75	46.00	-17.25	QP

EUT :	Lovense Lush 2	Model Name :	Lush 2
Relative Humidity:	52%	Phase:	V
Pressure:	1010 hPa	Test Voltage :	DC 5V from adapter
Test Mode :	TX+Charging		

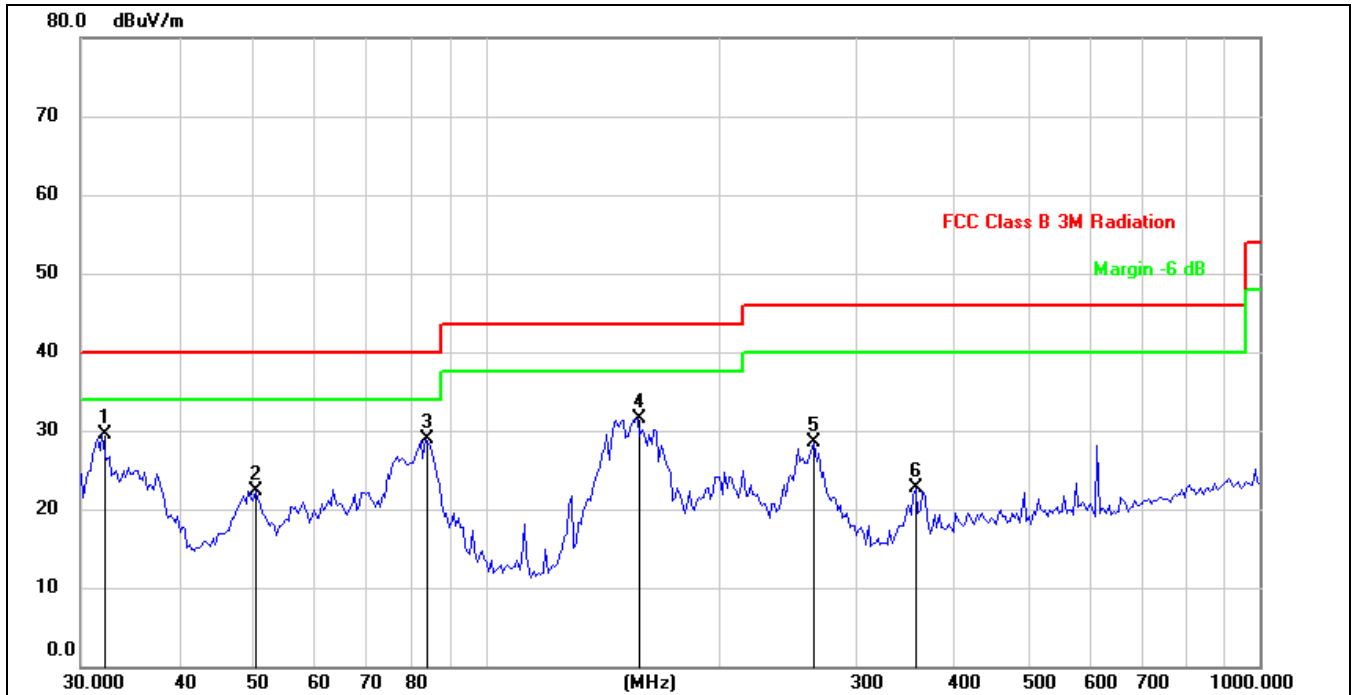

No.	Mk.	Freq. MHz	Reading Level dBuV	Correct Factor dBuV/m	Measure- ment dBuV/m	Limit dBuV/m	Over dB	Detector
1	*	31.9546	40.89	-11.44	29.45	40.00	-10.55	QP
2		50.4089	32.06	-9.73	22.33	40.00	-17.67	QP
3		83.5222	43.35	-14.36	28.99	40.00	-11.01	QP
4		157.0074	44.72	-13.17	31.55	43.50	-11.95	QP
5		265.6757	37.92	-9.45	28.47	46.00	-17.53	QP
6		359.1860	30.02	-7.40	22.62	46.00	-23.38	QP

1G-25GHz

Note: (1) All Readings are Peak Value (VBW=3MHz) and AV Value (VBW=10Hz).
 (2) Emission Level= Antenna Factor + Cable Loss + Read Level - Preamp Factor
 (3) All other emissions more than 20dB below the limit.

All the modulation modes have been tested, and the worst result was report as below:

Frequency (MHz)	Read Level (dBμV)	Cable loss (dB)	Antenna Factor dB/m	Preamp Factor (dB)	Emission Level (dBμV/m)	Limits (dBμV/m)	Margin (dB)	Remark	Comment
Low Channel (2402 MHz)-Above 1G									
4804.34	62.71	5.21	35.59	44.30	59.21	74.00	-14.79	Pk	Vertical
4804.34	42.82	5.21	35.59	44.30	39.32	54.00	-14.68	AV	Vertical
7206.11	61.97	6.48	36.27	44.60	60.12	74.00	-13.88	Pk	Vertical
7206.11	40.57	6.48	36.27	44.60	38.72	54.00	-15.28	AV	Vertical
4804.17	63.05	5.21	35.55	44.30	59.51	74.00	-14.49	Pk	Horizontal
4804.17	41.83	5.21	35.55	44.30	38.29	54.00	-15.71	AV	Horizontal
7206.21	61.77	6.48	36.27	44.52	60.00	74.00	-14.00	Pk	Horizontal
7206.21	42.34	6.48	36.27	44.52	40.57	54.00	-13.43	AV	Horizontal
Mid Channel (2440 MHz)-Above 1G									
4880.47	63.42	5.21	35.66	44.20	60.09	74.00	-13.91	Pk	Vertical
4880.47	43.42	5.21	35.66	44.20	40.09	54.00	-13.91	AV	Vertical
7320.27	66.08	7.10	36.50	44.43	65.25	74.00	-8.75	Pk	Vertical
7320.27	42.07	7.10	36.50	44.43	41.24	54.00	-12.76	AV	Vertical
4880.37	62.74	5.21	35.66	44.20	59.41	74.00	-14.59	Pk	Horizontal
4880.37	41.13	5.21	35.66	44.20	37.80	54.00	-16.20	AV	Horizontal
7320.23	59.61	7.10	36.50	44.43	58.78	74.00	-15.22	Pk	Horizontal
7320.23	44.12	7.10	36.50	44.43	43.29	54.00	-10.71	AV	Horizontal
High Channel (2480 MHz)- Above 1G									
4960.48	63.60	5.21	35.52	44.21	60.12	74.00	-13.88	Pk	Vertical
4960.48	42.82	5.21	35.52	44.21	39.34	54.00	-14.66	AV	Vertical
7440.13	64.12	7.10	36.53	44.60	63.15	74.00	-10.85	Pk	Vertical
7440.13	48.92	7.10	36.53	44.60	47.95	54.00	-6.05	AV	Vertical
4960.33	64.63	5.21	35.52	44.21	61.15	74.00	-12.85	Pk	Horizontal
4960.33	45.39	5.21	35.52	44.21	41.91	54.00	-12.09	AV	Horizontal
7440.2	64.33	7.10	36.53	44.60	63.36	74.00	-10.64	Pk	Horizontal
7440.2	44.63	7.10	36.53	44.60	43.66	54.00	-10.34	AV	Horizontal

5.4.4.2 Bandedge-radiated

- Note: (1) All Readings are Peak Value (VBW=3MHz) and AV Value (VBW=10Hz).
 (2) Emission Level= Antenna Factor + Cable Loss + Read Level - Preamp Factor
 (3) All other emissions more than 20dB below the limit.

All the modulation modes have been tested, and the worst result was report as below:

Frequency (MHz)	Meter Reading (dBμV)	Cable Loss (dB)	Antenna Factor dB/m	Preamp Factor (dB)	Emission Level (dBμV/m)	Limits (dBμV/m)	Margin (dB)	Detector Type	Comment
GFSK									
2310.00	62.53	2.97	27.80	43.80	49.50	74	-24.50	Pk	Horizontal
2310.00	42.73	2.97	27.80	43.80	29.70	54	-24.30	AV	Horizontal
2310.00	61.09	2.97	27.80	43.80	48.06	74	-25.94	Pk	Vertical
2310.00	42.99	2.97	27.80	43.80	29.96	54	-24.04	AV	Vertical
2390.00	64.28	3.14	27.21	43.80	50.83	74	-23.17	Pk	Vertical
2390.00	43.37	3.14	27.21	43.80	29.92	54	-24.08	AV	Vertical
2390.00	64.50	3.14	27.21	43.80	51.05	74	-22.95	Pk	Horizontal
2390.00	42.25	3.14	27.21	43.80	28.80	54	-25.20	AV	Horizontal
2483.50	62.13	3.58	27.70	44.00	49.41	74	-24.59	Pk	Vertical
2483.50	43.22	3.58	27.70	44.00	30.50	54	-23.50	AV	Vertical
2483.50	64.40	3.58	27.70	44.00	51.68	74	-22.32	Pk	Horizontal
2483.50	44.92	3.58	27.70	44.00	32.20	54	-21.80	AV	Horizontal

5.4.4.3 Spurious Emission in Restricted Band 3260MMHz-18000MHz

All the modulation modes have been tested, and the worst result was report as below:

Frequency (MHz)	Reading Level (dB μ V)	Cable Loss (dB)	Antenna Factor (dB/m)	Preamp Factor (dB)	Emission Level (dB μ V/m)	Limits (dB μ V/m)	Margin (dB)	Detector Type	Comment
3260	61.81	4.04	29.57	44.70	50.72	74	-23.28	Pk	Vertical
3260	57.10	4.04	29.57	44.70	46.01	54	-7.99	AV	Vertical
3260	65.13	4.04	29.57	44.70	54.04	74	-19.96	Pk	Horizontal
3260	57.80	4.04	29.57	44.70	46.71	54	-7.29	AV	Horizontal
3332	63.84	4.26	29.87	44.40	53.57	74	-20.43	Pk	Vertical
3332	56.22	4.26	29.87	44.40	45.95	54	-8.05	AV	Vertical
3332	65.55	4.26	29.87	44.40	55.28	74	-18.72	Pk	Horizontal
3332	51.18	4.26	29.87	44.40	40.91	54	-13.09	AV	Horizontal
17797	43.68	10.99	43.95	43.50	55.12	74	-18.88	Pk	Vertical
17797	33.14	10.99	43.95	43.50	44.58	54	-9.42	AV	Vertical
17788	42.77	11.81	43.69	44.60	53.67	74	-20.33	Pk	Horizontal
17788	34.50	11.81	43.69	44.60	45.40	54	-8.60	AV	Horizontal

5.5 Power spectral density test

5.5.1 Limit

FCC Part15 (15.247) , Subpart C			
Section	Test Item	Limit	Frequency Range (MHz)
15.247	Power Spectral Density	8 dBm (in any 3KHz)	2400-2483.5

5.5.2 Test procedure

1. Set analyzer center frequency to DTS channel center frequency.
2. Set the span to 1.5 times the DTS channel bandwidth.
3. Set the RBW \geq 3 kHz.
4. Set the VBW \geq 3 x RBW.
5. Detector = peak.
6. Sweep time = auto couple.
7. Trace mode = max hold.
8. Allow trace to fully stabilize.
9. Use the peak marker function to determine the maximum amplitude level.
10. If measured value exceeds limit, reduce RBW (no less than 3 kHz) and repeat.

5.5.3 Test setup



5.5.4 EUT operation conditions

The EUT tested system was configured as the statements of 2.1 Unless otherwise a special operating condition is specified in the follows during the testing

5.5.5 Test results

EUT :	LOVENSE Max 2	Model Name :	Max 2
Temperature :	25 °C	Relative Humidity :	60%
Pressure :	1015 hPa	Test Voltage :	DC 3.7V from battery
Test Mode :	TX Mode /CH00, CH19, CH39		

Frequency	Power Density (dBm/3KHz)	Limit (dBm/3KHz)	Result
2402 MHz	-13.077	8	PASS
2440 MHz	-12.801	8	PASS
2480 MHz	-13.636	8	PASS

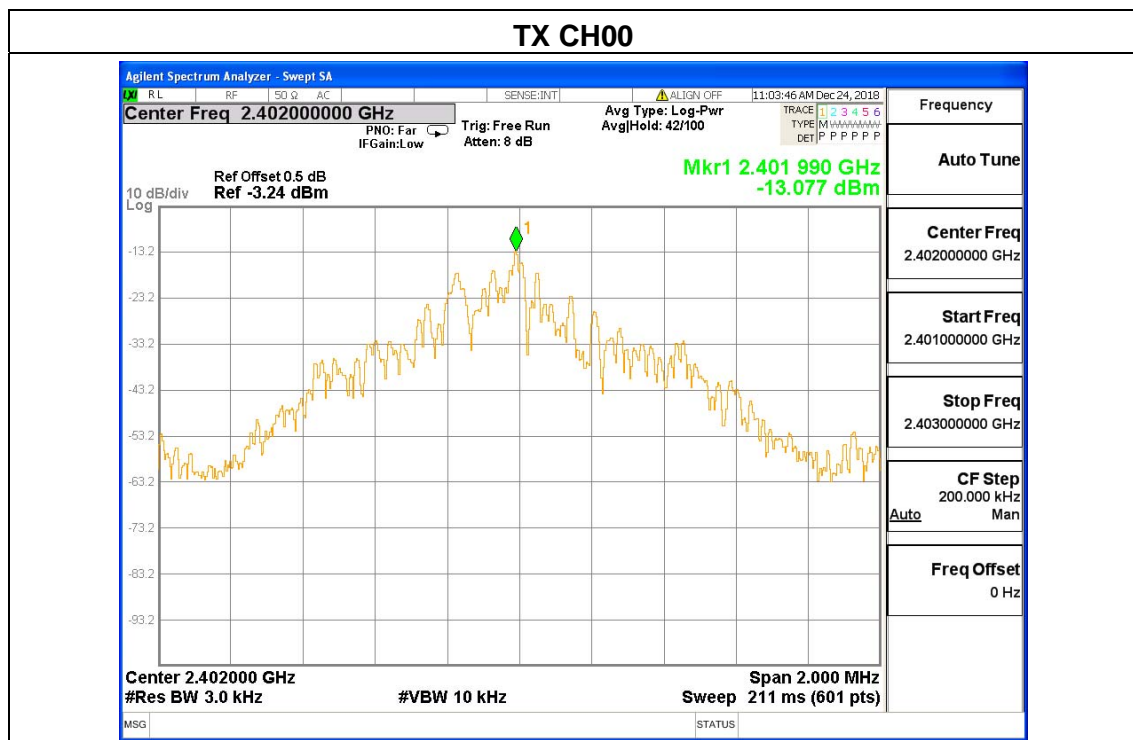

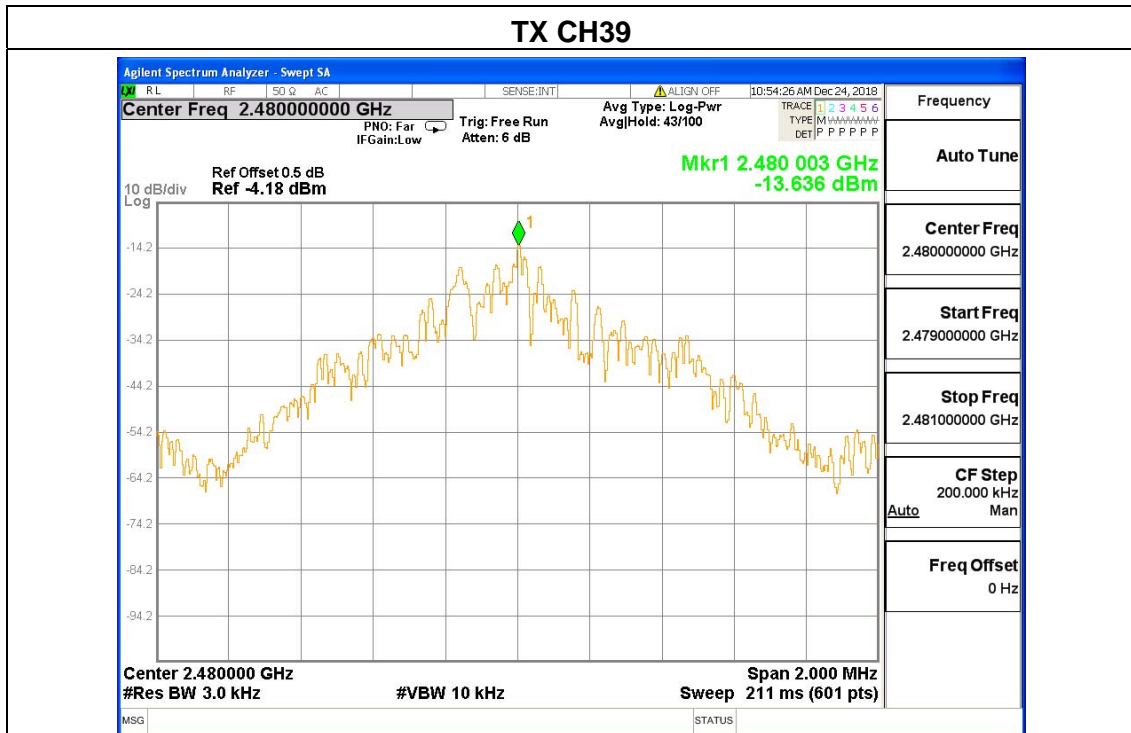
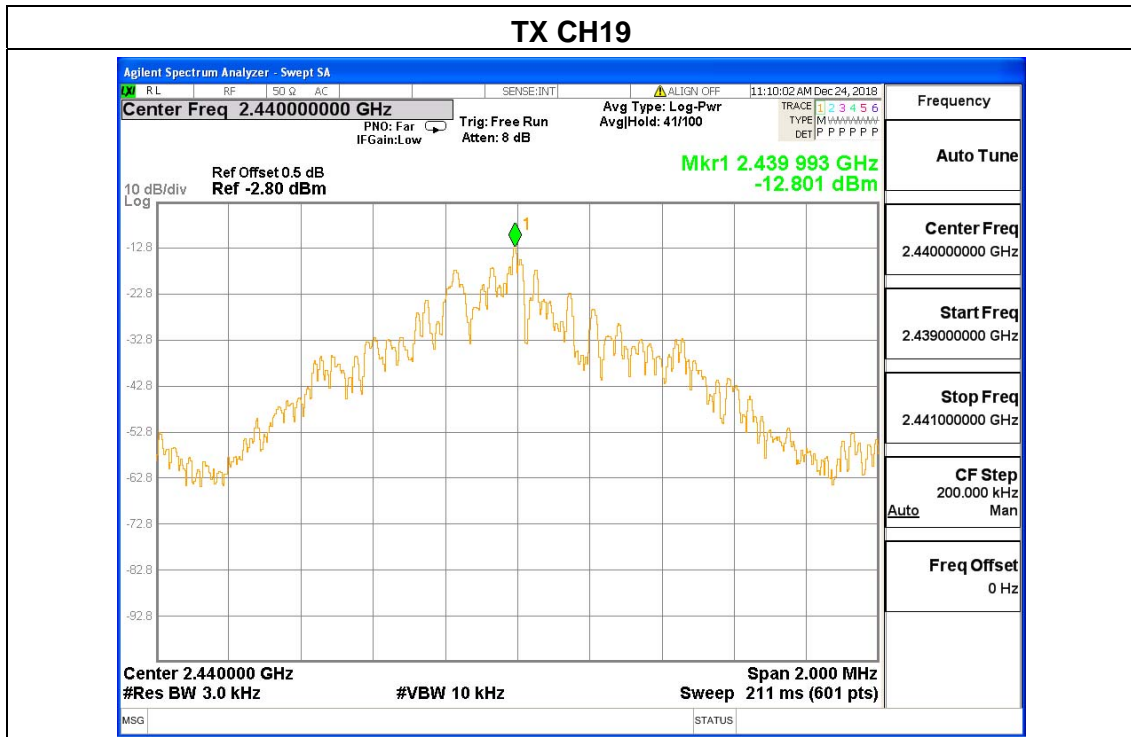

5.6 6dB bandwidth

5.6.1 Limit

FCC Part15 (15.247) , Subpart C			
Section	Test Item	Limit	Frequency Range (MHz)
15.247(a)(2)	Bandwidth	$\geq 500\text{KHz}$ (6dB bandwidth)	2400-2483.5

5.6.2 TEST PROCEDURE

1. Set RBW= 100 kHz.
2. Set the video bandwidth (VBW) $\geq 3 \times$ RBW.
3. Detector = Peak.
4. Trace mode = max hold.
5. Sweep = auto couple.
6. Allow the trace to stabilize.
7. Measure the maximum width of the emission that is constrained by the frequencies associated with the two outermost amplitude points (upper and lower) that are attenuated by 6 dB relative to the maximum level measured in the fundamental emission.

5.6.3 TEST SETUP



5.6.4 EUT operation conditions

The EUT tested system was configured as the statements of 2.1 Unless otherwise a special operating condition is specified in the follows during the testing

5.6.5 Test Result

EUT :	LOVENSE Max 2	Model Name :	Max 2
Temperature :	25 °C	Relative Humidity :	60%
Pressure :	1012 hPa	Test Voltage :	DC 3.7V from battery
Test Mode :	TX Mode /CH00, CH19, CH39		

Channel	Frequency (MHz)	6dB bandwidth (kHz)	Limit (kHz)	Result
Low	2402	718.8	500	Pass
Middle	2440	634.0	500	Pass
High	2480	731.8	500	Pass

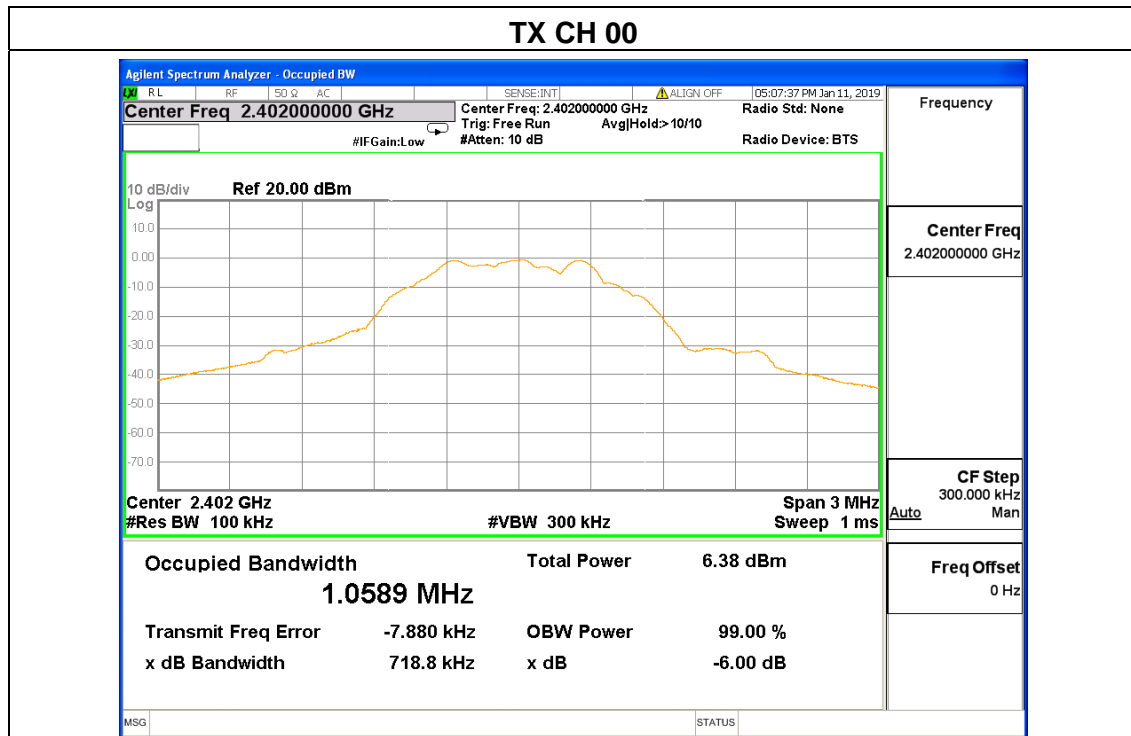

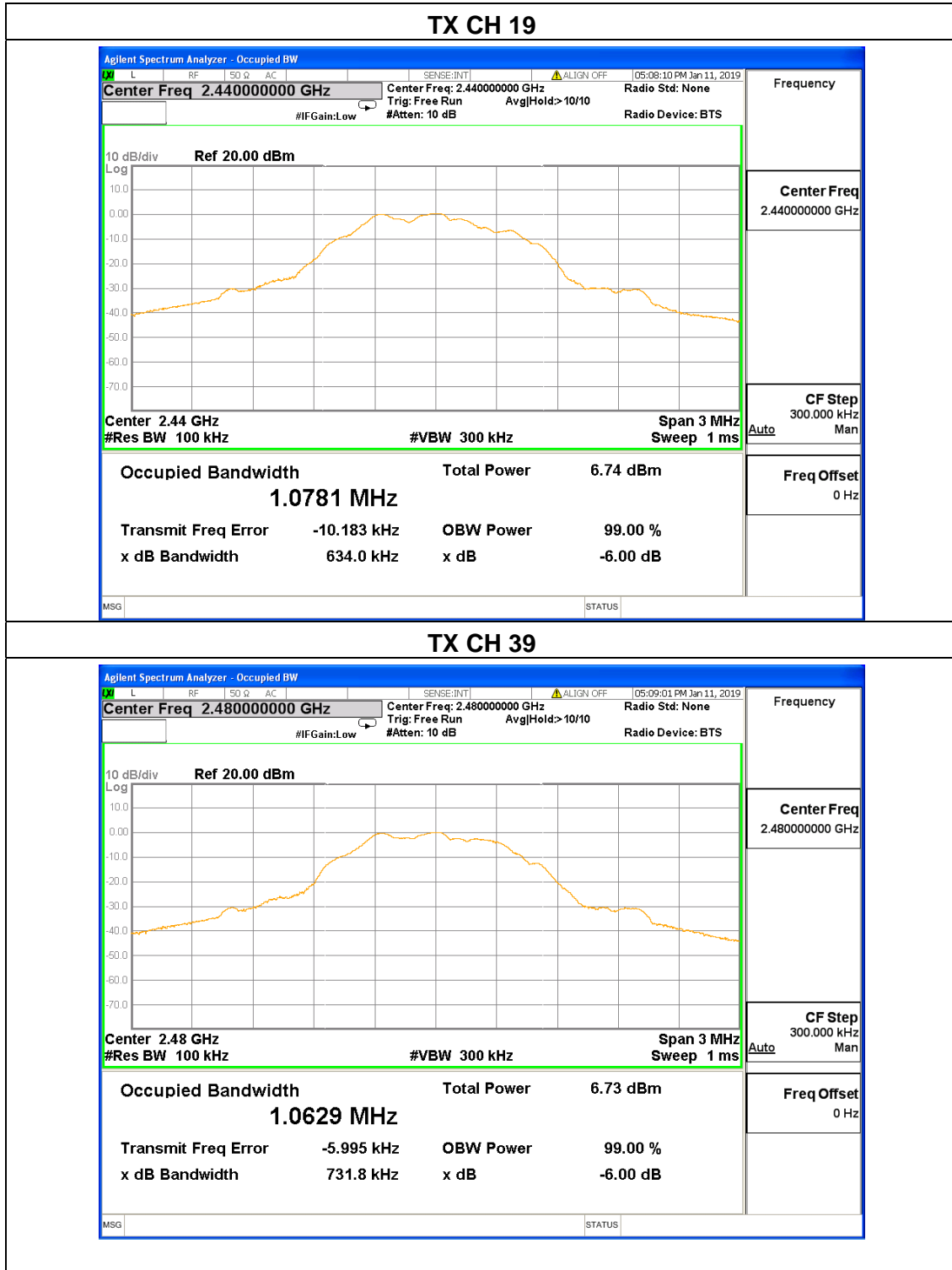

5.7 Conducted bandedge

5.7.1 Limits

In any 100 kHz bandwidth outside the frequency band in which the spread spectrum or digitally modulated intentional radiator is operating, the radio frequency power that is produced by the intentional radiator shall be at least 20 dB below that in the 100 kHz bandwidth within the band that contains the highest level of the desired power, based on either an RF conducted or a radiated measurement, provided the transmitter demonstrates compliance with the peak conducted power limits. If the transmitter complies with the conducted power limits based on the use of RMS averaging over a time interval, as permitted under paragraph (b)(3) of this section, the attenuation required under this paragraph shall be 30 dB instead of 20 dB. Attenuation below the general limits specified in §15.209(a) is not required. In addition, radiated emissions which fall in the restricted bands, as defined in §15.205(a), must also comply with the radiated emission limits specified in §15.209(a) (see §15.205(c)).

5.7.2 Test setup



5.7.3 Test procedure

- a) Check the calibration of the measuring instrument using either an internal calibrator or a known signal from an external generator.
- b) Position the EUT without connection to measurement instrument. Turn on the EUT and connect its antenna terminal to measurement instrument via a low loss cable. Then set it to any one measured frequency within its operating range, and make sure the instrument is operated in its linear range.
- c) Set RBW to 100 kHz and VBW of spectrum analyzer to 300 kHz with a convenient frequency span including 100 kHz bandwidth from band edge.
- d) Measure the highest amplitude appearing on spectral display and set it as a reference level. Plot the graph with marking the highest point and edge frequency.
- e) Repeat above procedures until all measured frequencies were complete.

5.7.4 EUT operation conditions

The EUT tested system was configured as the statements of 2.1 Unless otherwise a special operating condition is specified in the follows during the testing

5.7.5 Test Result

EUT :	LOVENSE Max 2	Model Name :	Max 2
Temperature :	25 °C	Relative Humidity :	60%
Pressure :	1012 hPa	Test Voltage :	DC 3.7V from battery
Test Mode :	TX Mode /CH00, CH39		

BLE: Band Edge, Left Side

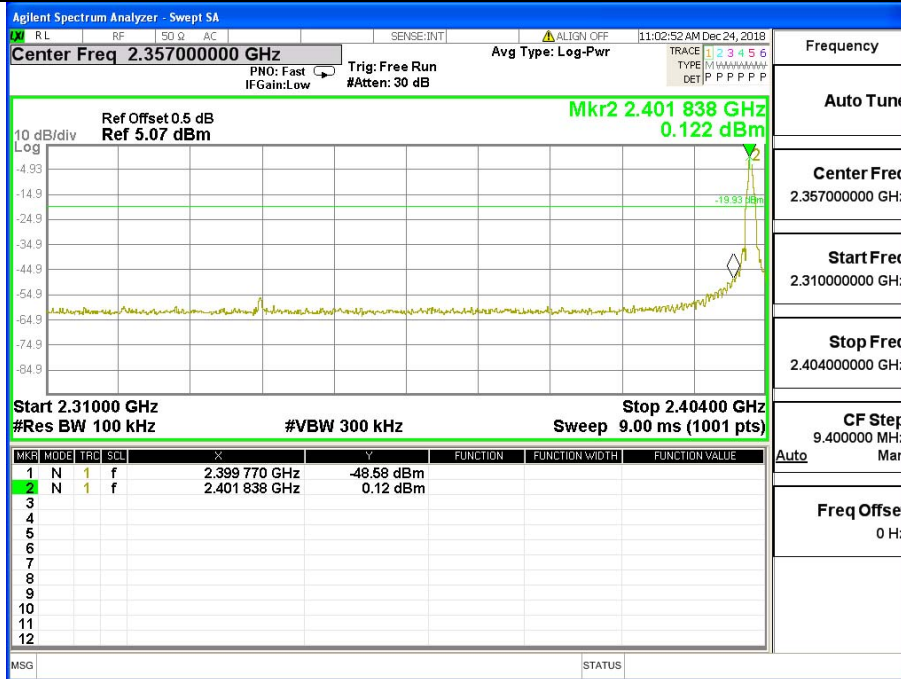

BLE: Band Edge, Right Side



5.8 Spurious RF Conducted Emissions

5.8.1 Conformance Limit

Below -20dB of the highest emission level in operating band.

5.8.2 Measuring Instruments

The Measuring equipment is listed in the section 6.3 of this test report.

5.8.3 Test Setup

Please refer to Section 6.1 of this test report.

5.8.4 Test Procedure

The Spurious RF conducted emissions compliance of RF radiated emission should be measured by following the guidance in ANSI C63.10-2013 with respect to maximizing the emission by rotating the EUT, measuring the emission while the EUT is situated in three orthogonal planes (if appropriate), adjusting the measurement antenna height and polarization etc. Set RBW=100kHz and VBW=300kHz to measure the peak field strength, and measure frequency range from 9kHz to 26.5GHz.

5.8.5 Test Results

Remark: The measurement frequency range is from 9kHz to the 10th harmonic of the fundamental frequency. The lowest, middle and highest channels are tested to verify the spurious emissions and band-edge measurement data.

The worst mode is GFSK CH19 mode, and the report only show the worst mode data.

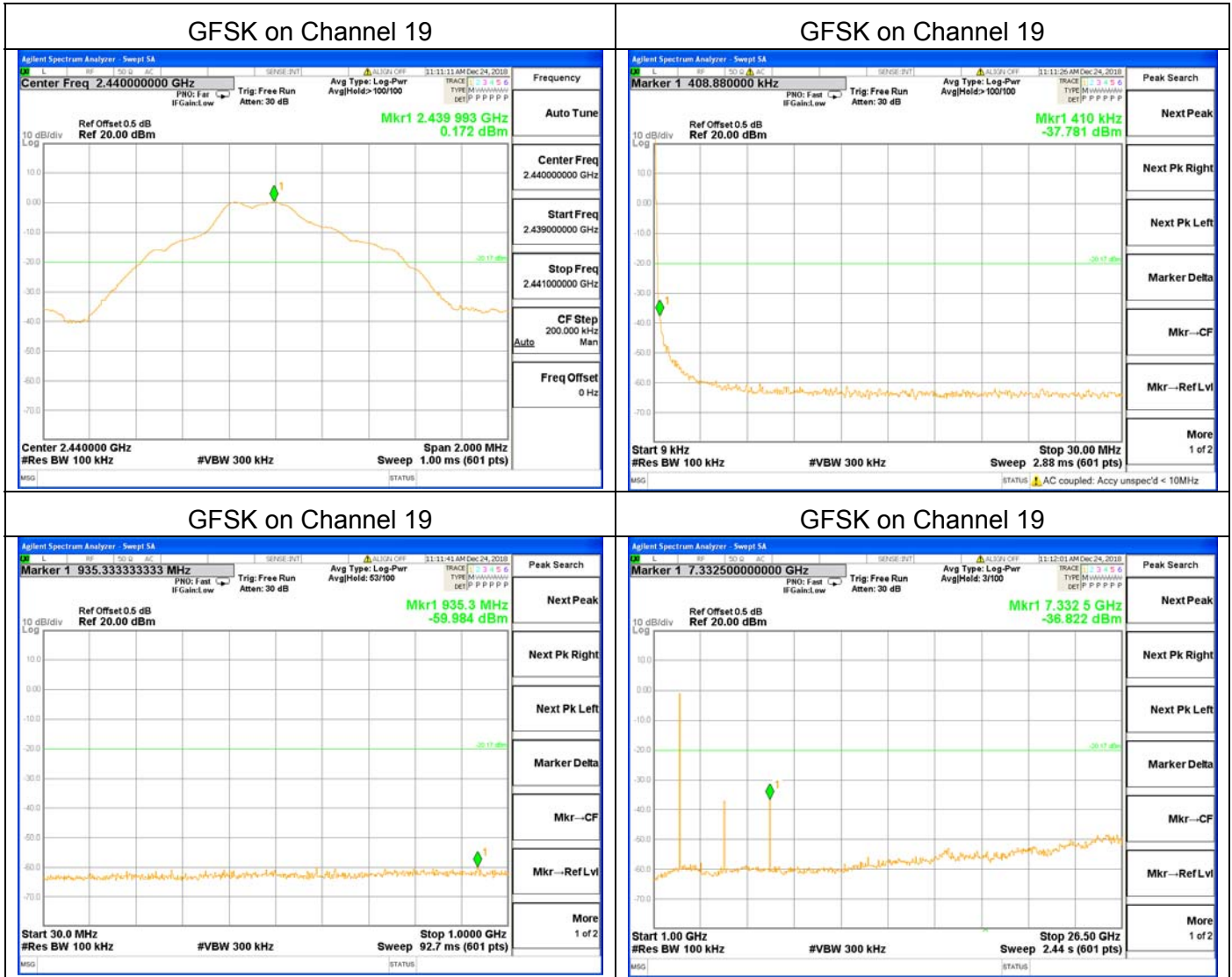

Photographs of the Test Setup

Radiated emission

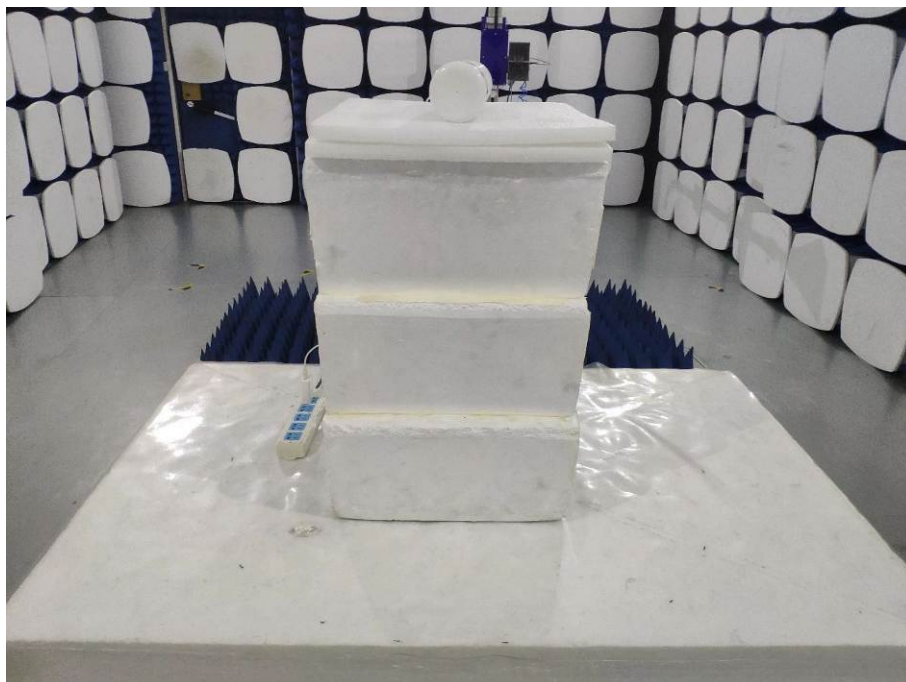
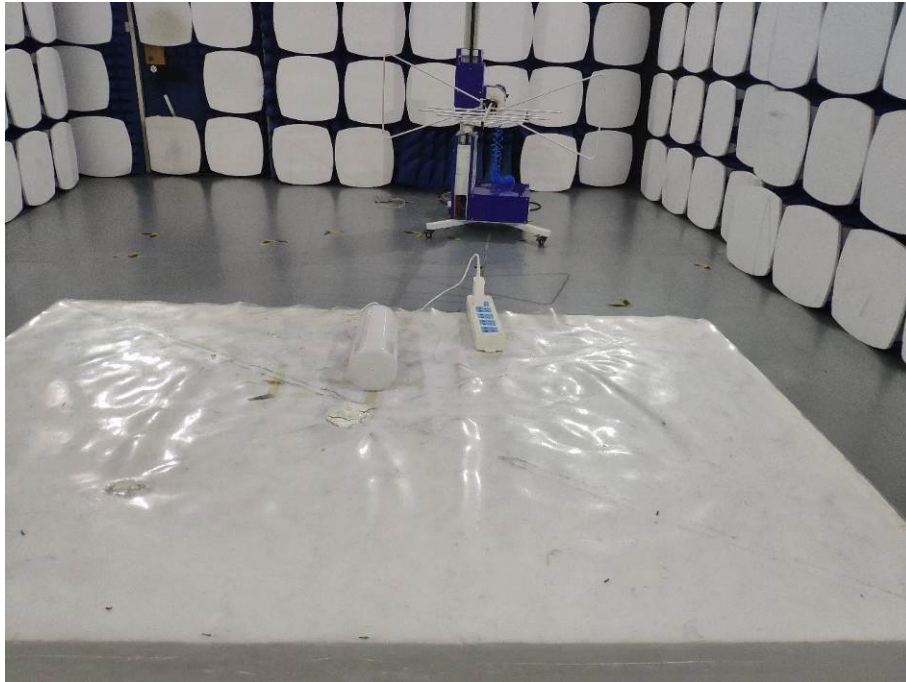

Conducted emission

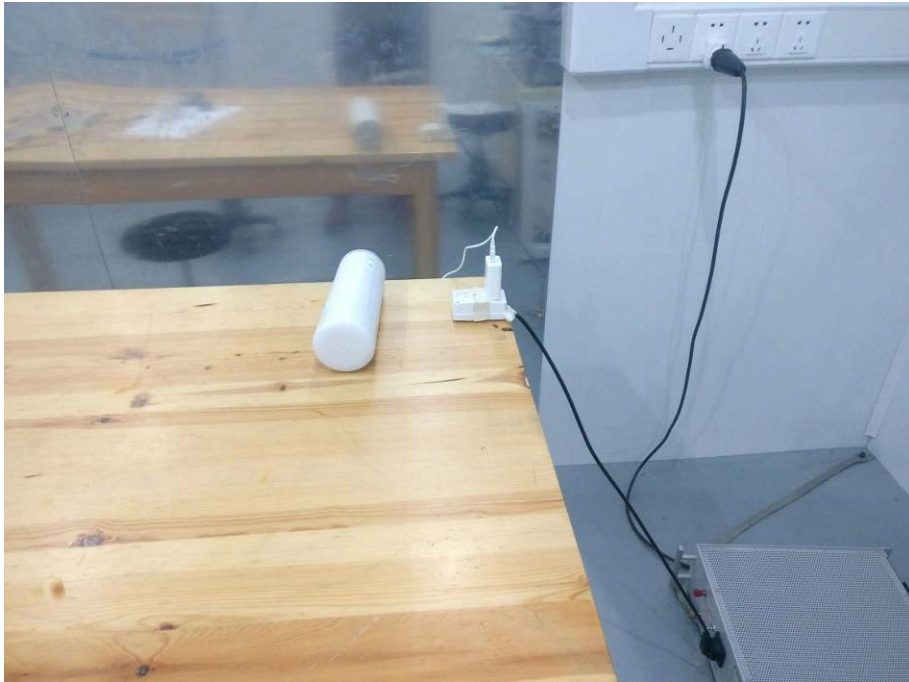

Photographs of the EUT

See the APPENDIX 1: EUT PHOTO in the report No.: MTi181225E146-1.

----END OF REPORT----