

SPEC NO.	SP03AE24425-0070	ISSUED DATE	2021.06.28	PUBLISHED BY
PRODUCT NAME	DCAH0S15	VERSION	01	
		PAGE	2/17	

CIROCOMM TECHNOLOGY.

PART NUMBER: 03A40D5M00J021T

1. SCOPE

This specification covers the **dielectric chip antenna** for **BT**.

2. Name of the product

This product is named "**Dielectric Chip Antenna**".

3. Electrical characteristics

3-1 Electrical characteristics of antenna

The antenna has the electrical characteristics given in Table 1 under the **cirocomm** standard installation conditions shown in the figure of Evaluation Board.

Table 1

No	Parameter	Specification
1	Working Frequency	2400-2500 MHz
2	Dimension	3.05×1.6×0.55 mm
3	Return Loss	< -10dB
4	VSWR	2.0max
5	Peak Gain	1.0 dBi (typ)
6	Polarization	Linear
7	Azimuth	Omni-directional
8	Impedance	50 Ω
9	Operating Temperature	-40~105°C

· **Data is measured on Cirocomm STD PCB.**

SPEC NO.	SP03AE24425-0070	ISSUED DATE	2021.06.28	PUBLISHED BY
PRODUCT NAME	DCAH0S15	VERSION	01	
		PAGE	3/17	

4. Antenna & Demo Board Dimension

4-1 Antenna Dimension

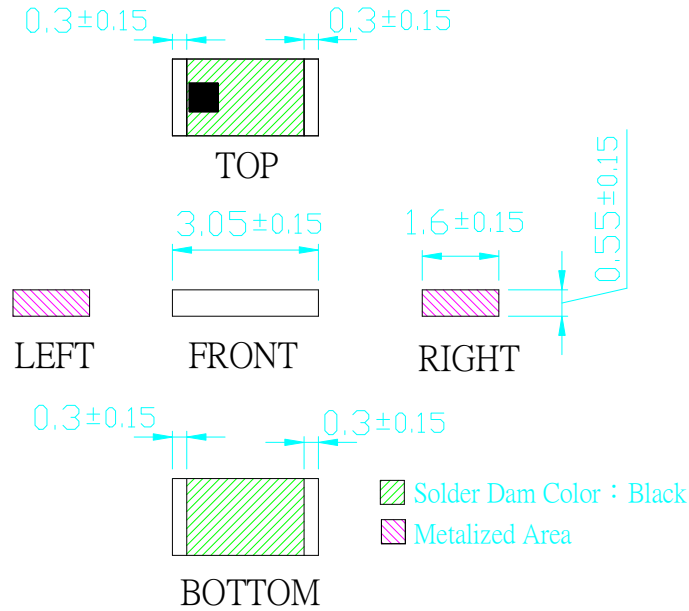

4-2 Demo Board Dimension

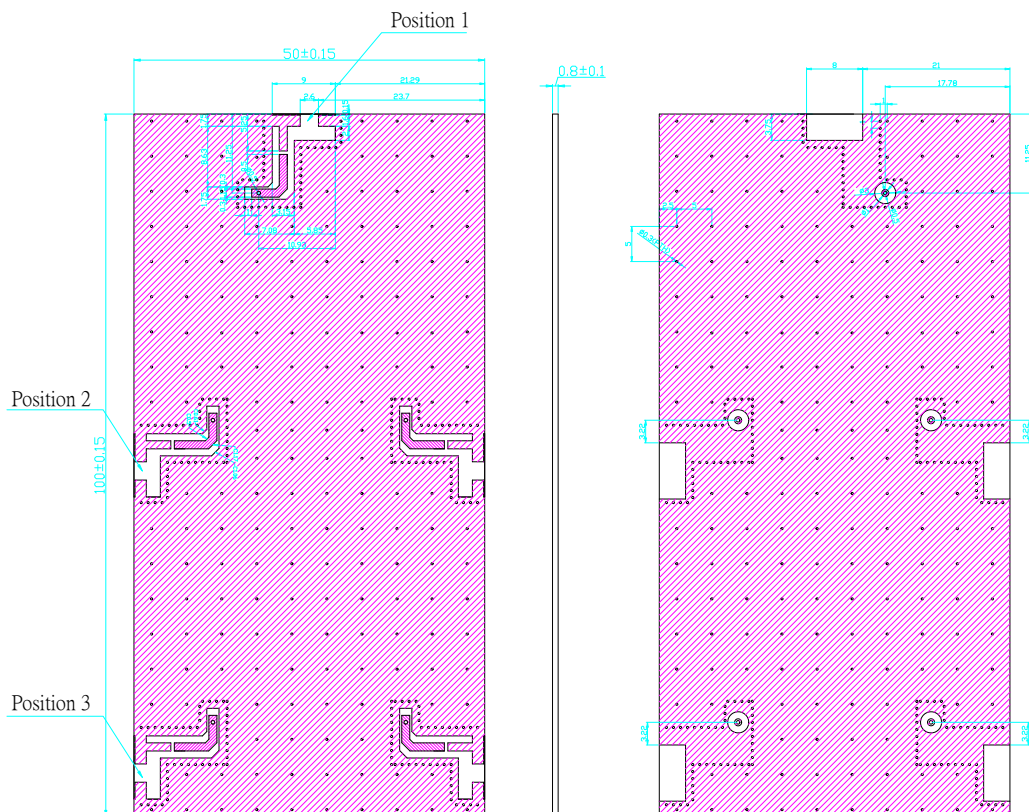

SPEC NO.	SP03AE24425-0070	ISSUED DATE	2021.06.28	PUBLISHED BY
PRODUCT NAME	DCAH0S15	VERSION	01	
		PAGE	10/17	

5-3 Position 3 Matching Circuit

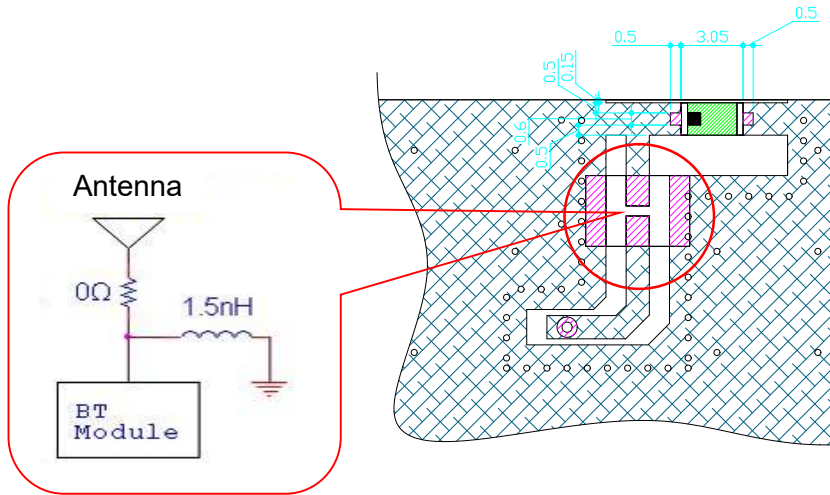

5-3-1 S11 Response curve (Work Frequency)

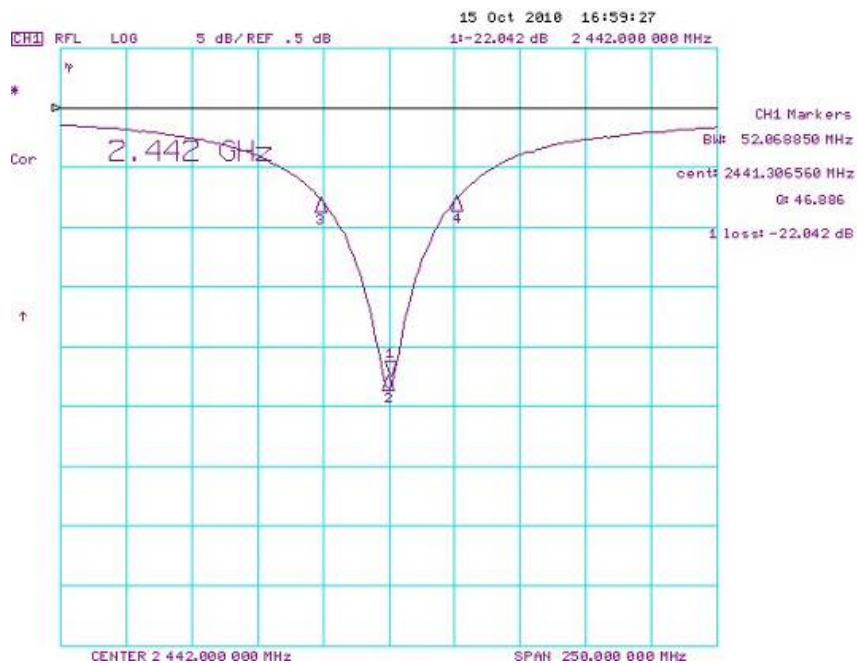

Item	Frequency	Return Loss	Bandwidth
Value	2442 MHz	-22.04 dB	52.06 MHz

SPEC NO.	SP03AE24425-0070	ISSUED DATE	2021.06.28	PUBLISHED BY
PRODUCT NAME	DCAH0S15	VERSION	01	
		PAGE	11/17	

5-3-2 Electrical performance

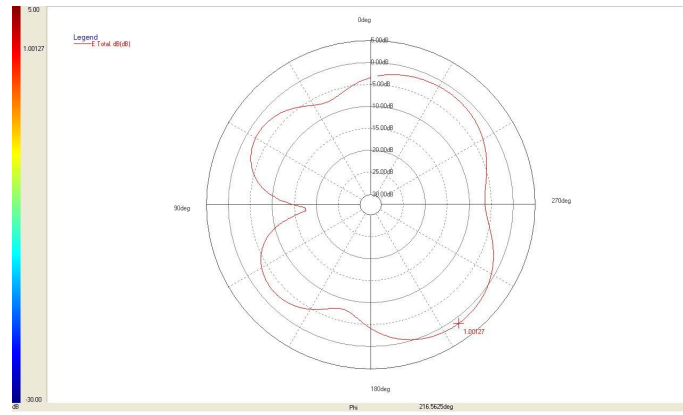

XY-Plane 2442MHz

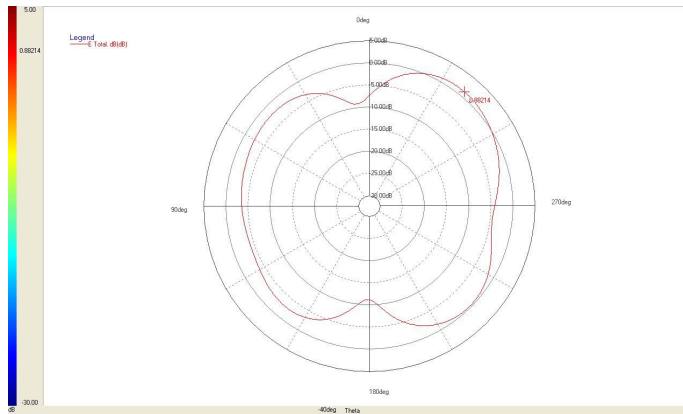

XZ-Plane 2442MHz

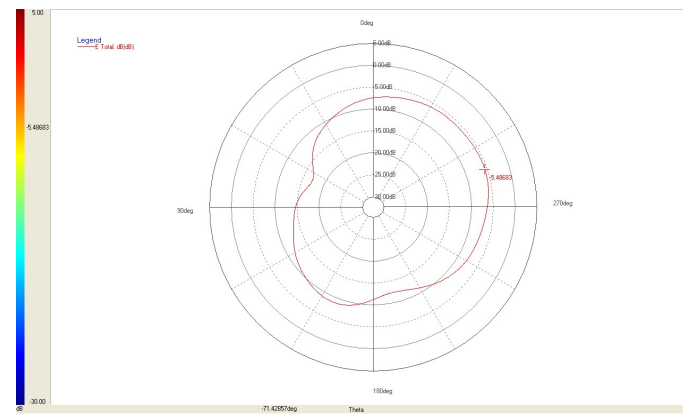

YZ-Plane 2442MHz

2442MHz	Peak Gain
XY-Plane	1.00
XZ-Plane	0.88
YZ-Plane	-5.48

(Unit : dBi)

SPEC NO.	SP03AE24425-0070	ISSUED DATE	2021.06.28	PUBLISHED BY
PRODUCT NAME	DCAH0S15	VERSION	01	
		PAGE	13/17	

6. Customer's Requirement Layout Dimension

6-1 Layout 1 Dimension

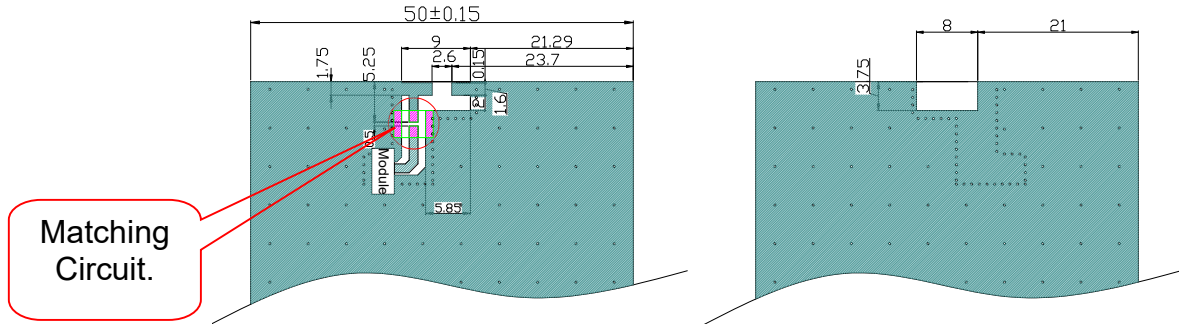

6-1-1 Single and Pad Layout Dimension

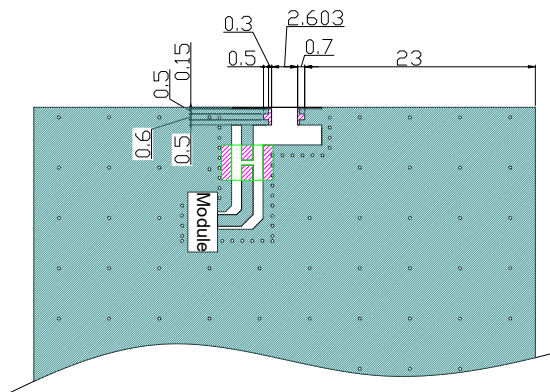

6-2 Layout 2 Dimension

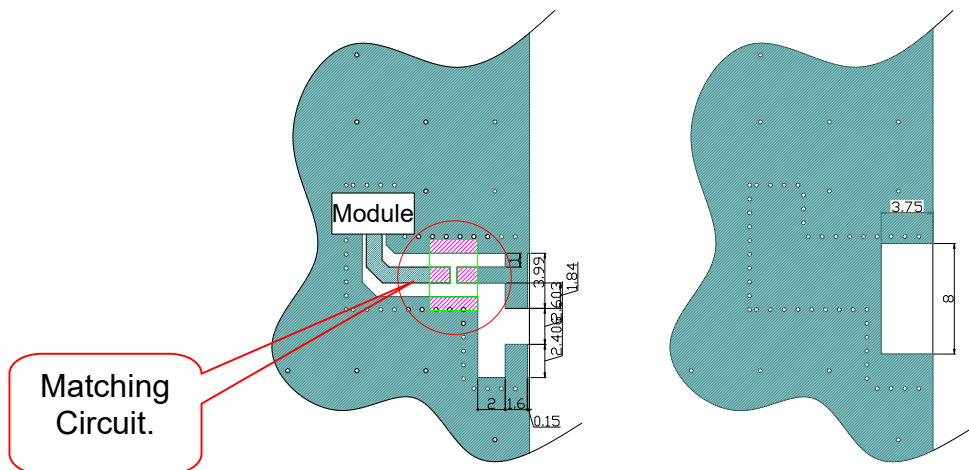

SPEC NO.	SP03AE24425-0070	ISSUED DATE	2021.06.28	PUBLISHED BY
PRODUCT NAME	DCAH0S15	VERSION	01	
		PAGE	14/17	

6-2-1 Single and Pad Layout Dimension

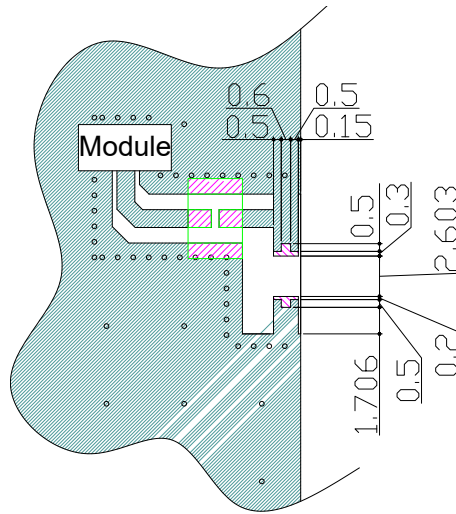

6-3 Layout 3 Dimension

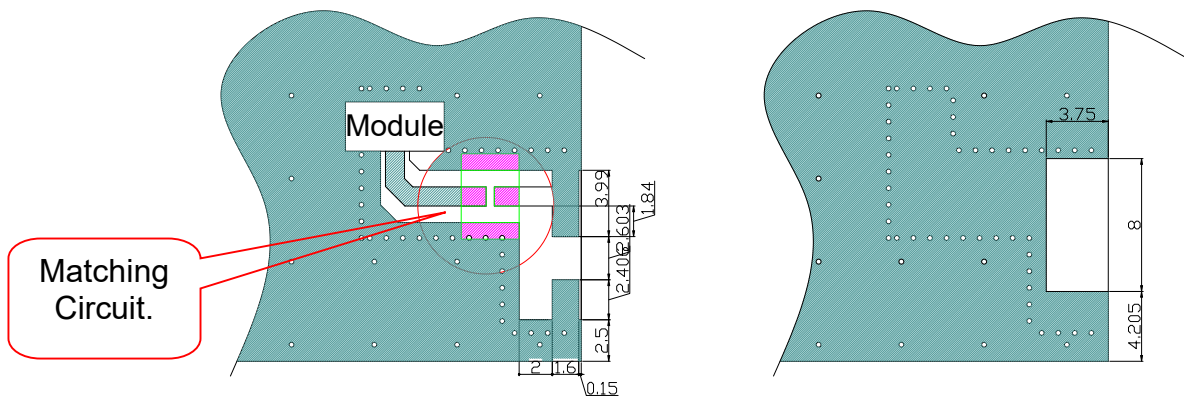

6-3-1 Single and Pad Layout Dimension

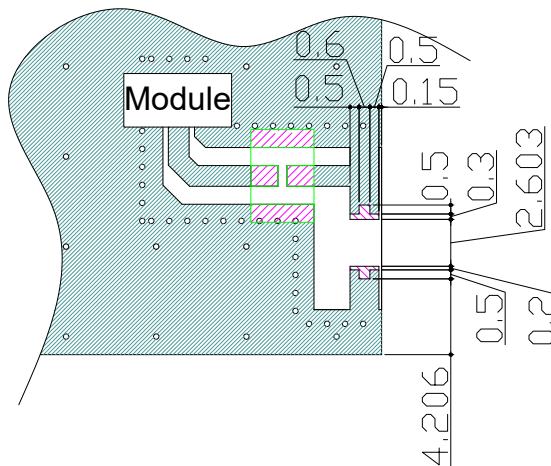

SPEC NO.	SP03AE24425-0070	ISSUED DATE	2021.06.28	PUBLISHED BY
PRODUCT NAME	DCAH0S15	VERSION	01	
		PAGE	15/17	

7. Environmental conditions

7-1 Operating conditions

The antenna has the electrical characteristics given in Tables 1 in the temperature range of -40°C to +85°C and under the environmental conditions of +40°C and 0-95% relative humidity.

7-2 Storage temperature range

The storage temperature range of product is -40°C to +85°C.

8. Reliability tests

8-1 Low-temperature test

Expose the specimen to -40°C for 16 hours and then to normal temperature/humidity for 24 hours or more. After this test, examine its appearance and functions.

8-2 High-temperature test

Expose the specimen to +85°C for 16 hours and then to normal temperature /humidity for 24 hours or more. After this test, examine its appearance and functions.

8-3 High-temperature/high-humidity test

Subject the object to the environmental conditions of +85°C and 90-95% relative humidity for 96 hours, then expose it to normal temperature/humidity for 24 hours or more. After this test, examine its appearance and functions.

8-4 Thermal shock test

Subject the object to cyclic temperature change (-40°C, 30 minutes ↔ +85°C, 30 minutes) for 5 cycles, then expose to normal temperature/ humidity for 24 hours or more.

8-5 Vibration test

8-5-1 Sinusoidal vibration test

Subject the object to vibrations of 5 to 200 to 5Hz swept in 10 minutes, 4.5G at maximum (2mm amplitude), in X and Y directions for two hours each and in Z direction for four hours. After this test, examine its appearance functions.

8-5-2 Vibration test in packaged condition

Subject the object, which is packaged as illustrated, to vibrations of 15 to 60 to 15Hz swept in 6 minutes, 4G at maximum (2mm amplitude at maximum), applied in X, Y and Z directions for two hours each, i.e. six hours in total. After this test, examine its appearance and functions.

8-6 Free fall test in packaged condition

Drop the object, which is packaged as illustrated, to a concrete surface from the height of 90 cm, on one corner, three edges and six faces once each, i.e. 10 times in total. After this test, examine its appearance and functions.

SPEC NO.	SP03AE24425-0070	ISSUED DATE	2021.06.28	PUBLISHED BY
PRODUCT NAME	DCAH0S15	VERSION	01	
		PAGE	16/17	

8-7 Soldering heat resistance test

The lead pins of the unit are soaked in solder bath at $260 \pm 5^{\circ}\text{C}$ for 10 seconds. After this test, examine its appearance and functions.

8-8 Adhesion test

The device is subjected to be soldered on test PCB. Then apply 0.5Kg (5N) of force for 5 ± 1 seconds in the direction of parallel to the substrate. (The soldering should be done by reflow and be conducted with care so that the soldering is uniform and free of defect by stress such as heat shock).

9. Warranty

If any defect occurs from the product during proper use within a year after delivery, it will be repaired or replaced free of charge.

10. Other

Any question arising from this specification manual shall be solved by arrangement made by both parties.

11. Precautions for use

- Antenna pattern use an Ag / Ni / Sn electrode.
- Please don't use the corrosion gas (sulfur gas, chlorine gas) in the atmosphere.
- Please don't direct solder onto the silver electrode of antenna pattern.

SPEC NO.	SP03AE24425-0070	ISSUED DATE	2021.06.28	PUBLISHED BY
PRODUCT NAME	DCAH0S15	VERSION	01	
		PAGE	17/17	

Delivery mode

- 1 .Blister tape to IEC 286-3, polyester.
- 2 .Pieces/ tape: 5000 pcs.
- 3 .Moisture sensitivity level: Level 1

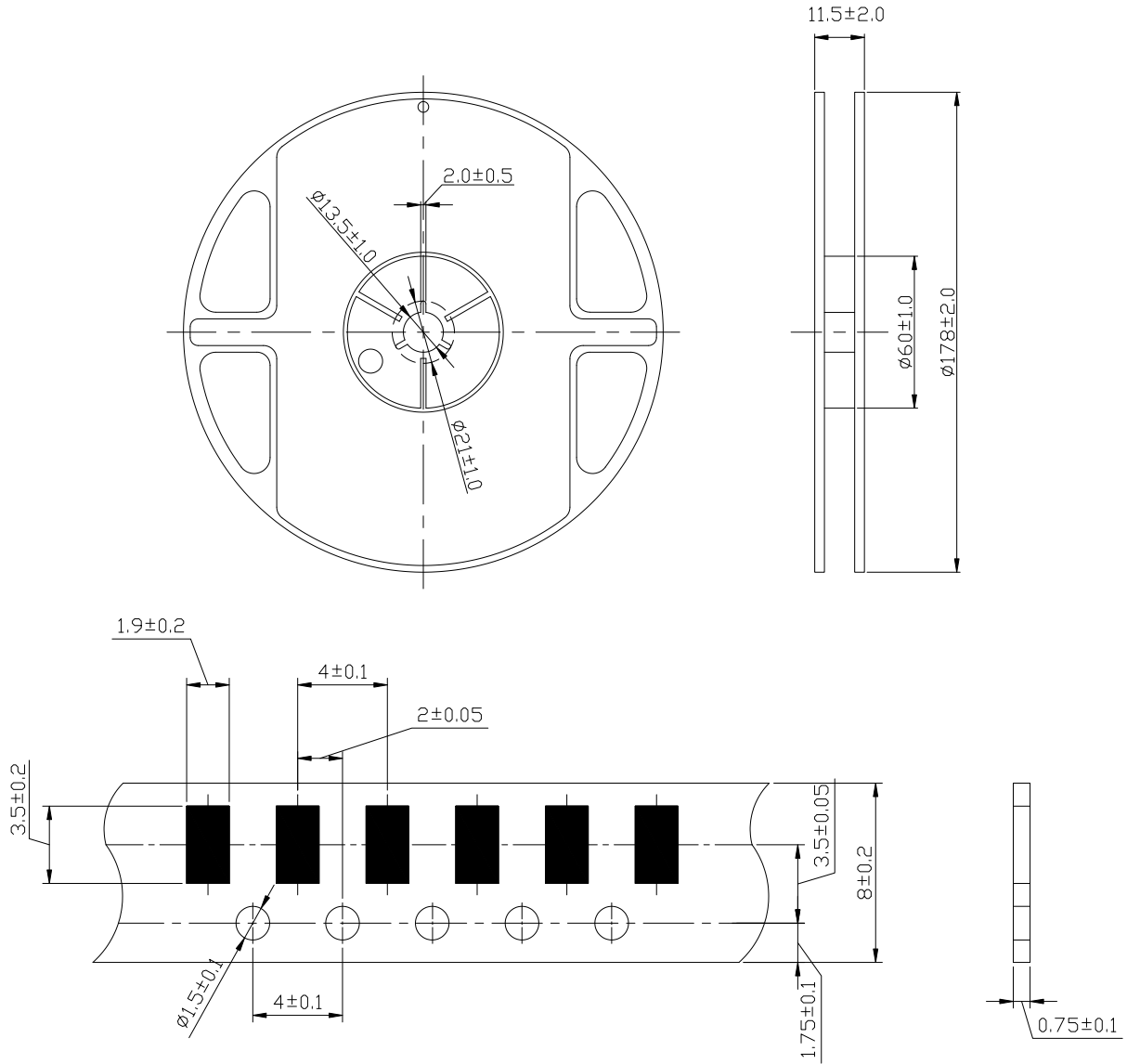

Marking direction

