

The TCL logo is displayed in white, bold, sans-serif capital letters within a black rounded square background in the top right corner of the page.

TCL

2.0 Channel Home Theater Sound Bar

Alto 7



User manual

Product Registration

Please register your purchase on-line at www.tclusa.com or www.tclcanada.com. It will make it easier to contact you should it ever be necessary. Registration is not required for warranty coverage.

Product Information

Keep your sales receipt to obtain warranty parts and service and for proof of purchase. Attach it here and record the serial and model numbers in case you need them. These numbers are located on the product.

Model No. _____

Purchase Date _____

Serial No. _____

Dealer/Address/Phone _____

Contents

1	Important safety instructions	3
	Important information	3
	Important safety instructions	5

2	Welcome	10
	What's in the box	10
	Overview of the Sound Bar main unit	12
	Overview of the remote control	14
	Set up your Sound Bar system	16

3	Connect your Sound Bar system	20
	Connect with the supplied HDMI cable	20
	Connect with the supplied optical cable	21
	Connect with the supplied 3.5mm-to-3.5mm audio cable	22
	Connect your Sound Bar to power supply	23
	Connect the Sound Bar with your Bluetooth device	24
	Connect the IR pass-through cable	26

4	Use your Sound Bar system	27
	Use your Sound Bar with the top panel or remote control	27
	Sound settings	28
	Control the Sound Bar with your TCL Roku TV remote control	29
	Listen to music from your Bluetooth device	31
	Use the USB cable or device for music playback	32



5	Specifications	34
---	----------------	----

6	Notice	35
	Compliance notice	35
	Disposal of your old product and battery	38
	Trademarks	39

7	FAQ	40
---	-----	----

1 Important safety instructions

Important information

	<p>CAUTION</p> <p>RISK OF ELECTRIC SHOCK DO NOT OPEN</p>	
<p>CAUTION: TO REDUCE THE RISK OF ELECTRIC SHOCK, DO NOT REMOVE COVER (OR BACK). NO USER-SERVICEABLE PARTS INSIDE. REFER SERVICING TO QUALIFIED SERVICE PERSONNEL.</p>		



The lightning flash with arrowhead symbol, within an equilateral triangle is intended to alert the user to the presence of uninsulated dangerous voltage within the

product's enclosure that may be of sufficient magnitude to constitute a risk of electric shock.



The exclamation point within an equilateral triangle is intended to alert the user to the presence of important operating and maintenance (servicing) instructions in the literature accompanying the product.



This symbol indicates that this product incorporates double insulation between hazardous main voltage and user accessible parts. When servicing, use only identical replacement parts.

Warnings

- *To reduce the risk of fire or electric shock, do not expose this product to rain or moisture. This product should not be exposed to dripping or splashing. No objects filled with liquids, such as vases, should be placed on or near the product.*
- *The product is unstable if it is not properly placed or mounted to the wall. Be sure to follow the wall mounting instructions provided in this user manual to ensure your safety.*
- *Do not expose batteries to excessive heat such as sunshine, fire, and so forth.*

Important safety instructions

- **Read these instructions** - Read all the safety and operating instructions before operating the product.
- **Retain these instructions** - Retain the safety and operating instructions for future reference.
- **Heed all warnings** - Adhere to all warnings on the product and in the operating instructions.
- **Follow all instructions** - Follow all operating and use instructions.
- **Do not use this apparatus near water** – The appliance should not be used near water or moisture – for example, in a wet basement or near a swimming pool and the like
- **Clean only with a dry cloth.**
- **Do not block any ventilation openings.** Install in accordance with the manufacturer's instructions.
- **Do not install near any heat sources** such as radiators, heat registers, stoves, or other apparatus (including amplifiers) that produce heat.
- **Do not defeat the safety purpose** of the polarized or grounding-type plug. A polarized plug has two blades with one wider than the other. A grounding type plug has two blades and a third grounding prong. The wide blade or the third prong are provided for your safety. If the provided plug does not fit into your outlet, consult an electrician for replacement of the obsolete outlet.
- **Protect the power cord** from being walked on or pinched particularly at plugs, convenience receptacles, and the point where it exits from the product.

- **Use only attachments/accessories** specified by the manufacturer.
- **Use only with the cart**, stand, tripod, bracket, or table specified by the manufacturer, or sold with the apparatus. When a cart is used, use caution when moving the cart/apparatus combination to avoid injury from tip-over.



- **Unplug this apparatus** during lightning storms or when unused for long periods of time.
- **Refer all servicing** to qualified service personnel. Servicing is required when the apparatus has been damaged in any way, such as power-supply cord or plug damaged, liquid has been spilled or objects have fallen into the apparatus, the apparatus has been exposed to rain or moisture, does not operate normally, or has been dropped.

Cautions

- To prevent electric shock, match wide blade of plug to wide slot, fully insert
- The product shall not be exposed to dripping or splashing.
- Do not place any sources of danger on the product (for example, liquid filled objects, lighted candles).
- Disconnect the power cord to shut off when find trouble or not in use. The power cord shall be readily operable.
- Use of controls or adjustments or performance of procedures other than those described herein, may result in hazardous radiation exposure or other unsafe operation.
- To reduce the risk of fire or electric shock, do not expose this apparatus to rain or moisture. The apparatus must not be exposed to dripping or splashing and objects filled with liquids, such as vases, must not be placed on apparatus.
- The power cord/appliance coupler is used as the disconnect device, the disconnect device must remain readily operable.

Battery caution and disposal information

- Install only new batteries of the same type in your product.
- Failure to insert batteries in the correct polarity, as indicated in the battery compartment, may shorten the life of the batteries or cause batteries to leak.
- Do not mix old and new batteries.

- Do not use rechargeable (Nickel Cadmium) or (Nickel Metal Hydride) batteries.
- Do not mix alkaline, standard (Carbon-Zinc) or rechargeable (Nickel Cadmium) or (Nickel Metal Hydride) batteries.
- Do not dispose of batteries in fire or water.
- Recycle or dispose of batteries as per state and local guidelines.
- Danger of explosion if battery is incorrectly replaced. Replace only with the same or equivalent type.
- When the remote control is not to be used for a long time (more than a month), remove the battery from the remote control to prevent it from leaking.
- If the batteries leak, wipe away the leakage inside the battery compartment and replace the batteries with new ones.
- Keep away the batteries from heat or moisture.
- Do not carry or store batteries with other metallic objects. Doing so could cause batteries to short circuit, leak or explode.
- Do not carry or store batteries with other metallic objects. Doing so could cause batteries to short circuit, leak or explode.
- Never recharge a battery unless it is confirmed to be a rechargeable type.

Installation location

- This product is designed to sit on a firm, flat surface. Do not place the product on built-in installation such as a bookcase or rack because the ventilation slots around the product will be blocked, resulting in reduced lifetime from overheating. To assure adequate ventilation for this product, maintain a spacing of 7.8 inches (20cm) or more around the product.
- Make sure the product on the furniture is of adequate size and strength to prevent it from being accidentally tipped over, pushed off, or pulled off. This could cause personal injury and/or damage to the product.
- Installation of wall mount must be carried out by qualified personnel only. Incorrect assembly can result in severe personal injury and property damage (if you intend to install this product yourself, you must check for installations such as electrical wiring and plumbing that may be buried inside the wall). It is the installer's responsibility to verify that the wall will safely support the total load of the product and wall mount brackets.

2 Welcome

Congratulations on the purchase of your new TCL Sound Bar! After it is set up and connected, you can experience a superb sound quality and state-of-the-art design to best fit your home entertainment system. You are recommended to read through this user manual which helps you set up, connect and operate the product easily and properly. For more information, visit www.tclusa.com or www.tclcanada.com

Let's get started.

What's in the box



Sound Bar main unit

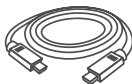

HDMI cable



Remote control



Optical cable



3.5mm-to-3.5mm audio cable

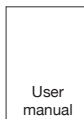

User manual



IR pass-through cable



Quick start guide

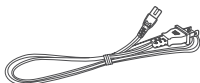

AC power cord



Wall mount template



AAA battery x 2





Warranty card

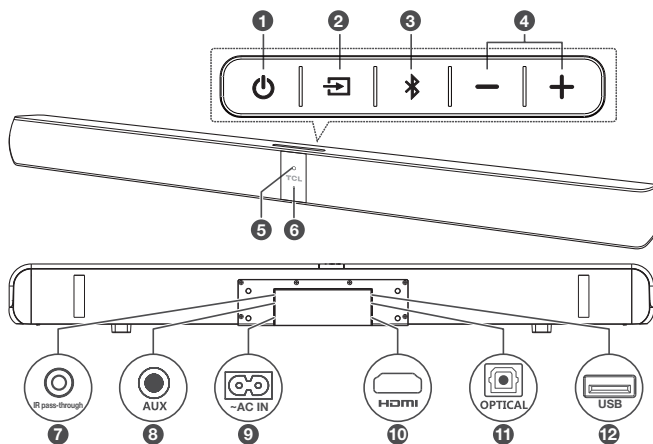

Wall screw (M3.6) x 2
Wall anchor x 2

Overview of the Sound Bar main unit







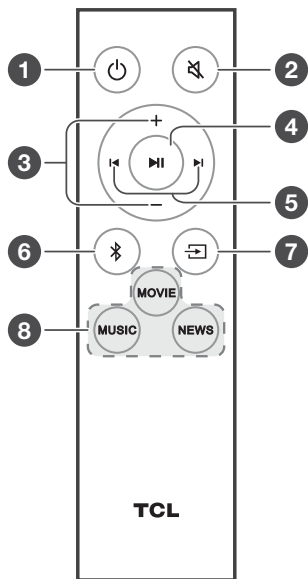

- 1  Press to turn the Sound Bar main unit on or to standby mode.
- 2  Press to switch the audio source among HDMI/USB/AUX/Bluetooth/Optical modes.

- 3  Press to select the Bluetooth function.
- 4 **+/-** Press to increase or decrease the volume level.
- 5 **Remote control sensor**
Receive signals from the remote control.
- 6 **LED indicator**
Red: in standby mode.
Purple: in HDMI mode.
Green: in AUX mode.
Blue: in Bluetooth mode.
Yellow: in Optical mode.
White: in USB mode.
- 7 **IR pass-through cable connector**
- 8 **AUX input connector**
- 9 **AC input power connector**
- 10 **HDMI ARC connector**
- 11 **Optical input connector**
- 12 **USB Type A connector (only for music playback)**

Overview of the remote control



- 1  Press to turn the Sound Bar on or to standby mode.
- 2  Press to mute or unmute the sound.
- 3  Press to increase or decrease the volume level.

- 4  Play/pause/resume playback in Bluetooth/USB mode. Press and hold for 3 seconds to disconnect the Bluetooth function.
- 5  Press to skip to previous or next track in Bluetooth/USB mode.
- 6  Press to switch the audio source to Bluetooth mode.
- 7  Press to switch the audio source among HDMI/USB/AUX/Bluetooth/Optical modes.
- 8 **NEWS/MOVIE/MUSIC**
Press to select the equalizer (EQ) effect when you are watching **news** or **movies** or listening to **music**.

Set up your Sound Bar system

Notes

- Make sure you read all the safety information before you mount the Sound Bar main unit on the wall. (see 'Important safety instructions' on page 5).
- Make sure you use screws provided or specified by the authorized manufacturer.
- TCL Corporation bears no responsibility for accidents or damage caused by improper wall mounting and screws installation or insufficient wall strength, etc.
- Additional tools (not supplied) are required for installation.

Mount your Sound Bar main unit on the wall

You can choose to place your Sound Bar main unit below the center of your TV or mount it on the wall.

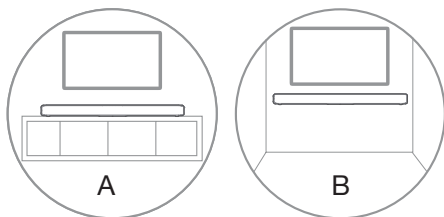

- 1 Place the supplied wall mount template on the wall. Make sure the wall mount template is at least 2 inches (5cm) below the center of the TV.
- 2 Use a level to make sure the Sound Bar is positioned accurately.
- 3 Use the tape to stick the wall mount template firmly on the wall.
- 4 Mark on the wall using each marking on the template through the mounting holes (Fig.1).
- 5 Take away the wall mount template.
- 6 Drill a screw hole at each marking on the wall.
- 7 Insert the supplied wall anchors into 2 screw holes on the wall (Fig. 1).
- 8 Insert the supplied screws into the wall anchors. Leave 4mm between the screw heads and the wall (Fig. 2).
- 9 Fix and tighten the screws on the wall (Fig. 3).
- 10 Hang the Sound Bar main unit on the screws (Fig. 3).

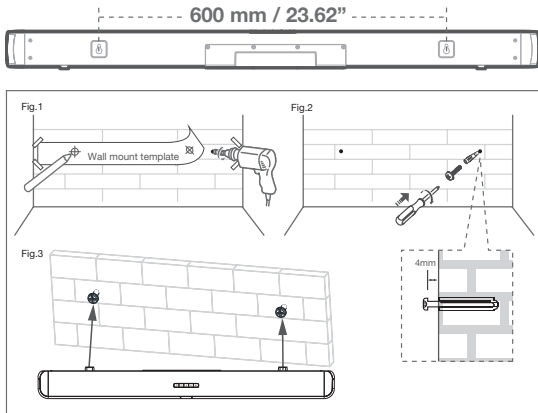

Notes

- Check the installation location before you mount the Sound Bar on the wall (see 'Installation location' on page 9).
- You may consider to connect the cables first before mounting the Sound Bar on the wall.

Install/replace the remote control batteries

Warnings

- *Danger of explosion if battery is incorrectly replaced. Replace only with the same or equivalent type.*

Caution

- The battery contains perchlorate material, handle it with care. For information, refer to [www. dtsc. ca.gov/hazardous_waste/perchlorate](http://www.dtsc.ca.gov/hazardous_waste/perchlorate).

- 1 Open the battery compartment, remove the old batteries if necessary.
- 2 Place two new AAA batteries into the battery compartment with the correct polarity (+/-).
- 3 Close the battery compartment.

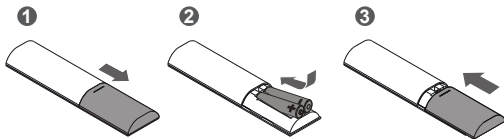

3 Connect your Sound Bar system

After you have fixed the position of the Sound Bar main unit, you can start connecting it to your TV or other devices and listen to the audio through your Sound Bar. Make sure you have muted the audio of your TV or device. For information, check the user manual of your TV or device.

Connect with the supplied HDMI cable

Note

- Make sure your TV or device supports the HDMI ARC feature. For information, check the user manual of your TV or device.

Connect one end of the HDMI cable to the HDMI ARC input connector on your Sound Bar main unit and another end to the HDMI ARC output connector of your TV or device.

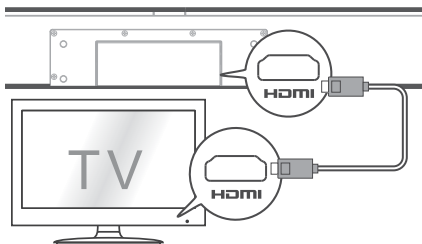

Connect with the supplied optical cable

- 1 Remove the protective caps from the optical cable.
- 2 Connect one end of the optical cable to the optical input connector on your Sound Bar main unit and another end to the optical output connector of your TV or device.

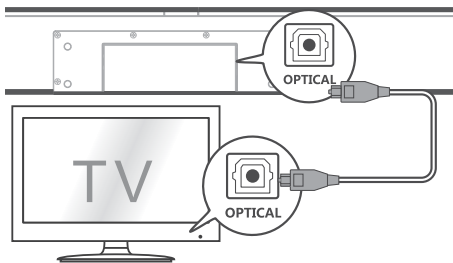

Note

- If there is no sound output from the Sound Bar main unit and the yellow LED flashes rapidly, try to activate the PCM signal output on your TV or device. PCM is used to convert analog audio signals into digital audio signals in most devices. For more information of how to activate the PCM signal output, check the user manual of your TV or device.

Connect with the supplied 3.5mm-to-3.5mm audio cable

You can either:

- connect one end of the supplied 3.5mm-to-3.5mm audio cable to the AUX input connector on your Sound Bar main unit and another end to the headphone or audio output connector on your TV or device. This will disable the sound of your TV built-in speakers; or
- connect one end of an RCA-to-3.5mm audio cable (not supplied) to the AUX input connector on your Sound Bar main unit and other ends to the TV's audio output connectors.

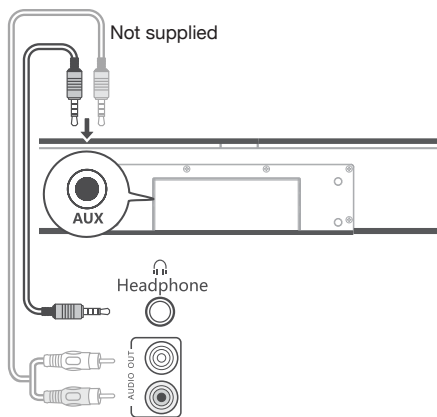

Connect your Sound Bar to power supply

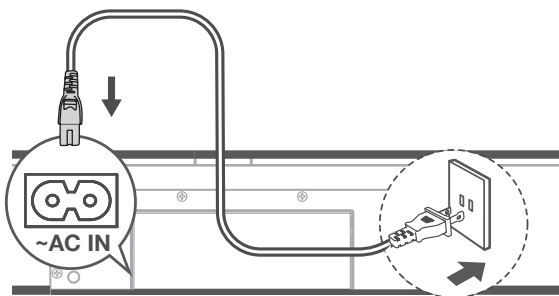

- 1 Make sure that you have completed all other connections before connecting the Sound Bar to power supply.
- 2 Make sure the power supply voltage complies with your country's safety standards (see 'Specifications' on page 34).
- 3 Connect one end of a supplied AC power cord to the AC input connector on your Sound Bar main unit and another end to the power socket on the wall.



Connect the Sound Bar with your Bluetooth device

Notes



- Make sure your wireless device supports the Bluetooth function.
- The operational range between the Sound Bar main unit and your Bluetooth device is approximately 10 meters (without any obstacle between the Bluetooth device and Sound Bar main unit).

- 1 Press  on the top panel of your Sound Bar main unit or remote control to power on the Sound Bar.
- 2 Press  on the top panel of your Sound Bar main unit or remote control.
 - The blue LED flashes slowly. The Sound Bar is ready to pair.
- 3 Power on your Bluetooth device and activate its Bluetooth function.
- 4 Select **TCL Alto 7** on the pairing list of your Bluetooth device.
 - You hear distinct double beep sound.
 - The blue LED remains on solidly when pairing is successful.

Tip

- If you cannot find the model name **TCL Alto 7** on your Bluetooth device, press and hold  on the remote control. You will see the blue LED flashes rapidly. Now the Sound Bar main unit is entering the pairing mode.

Your Sound Bar system is now set up and ready to use.

- 5 To disconnect the Bluetooth function, you can:
- press  on the Sound Bar main unit or remote control to switch to another source; or
 - disable the Bluetooth function on your device; or
 - press and hold  on the remote control for 3 seconds.

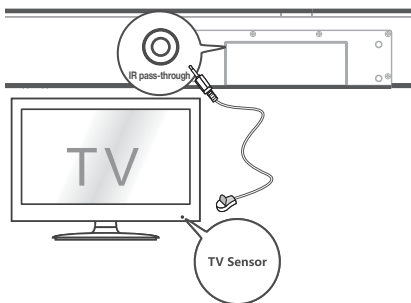

Connect the IR pass-through cable

If the Sound Bar blocks the IR receiver of the TV when placing directly in front of it, you can connect the Sound Bar and TV with the supplied IR pass-through cable so that it can receive signal from the remote control of your TV. Connect one end of the IR pass-through cable to the IR pass-through cable connector on your Sound Bar main unit. Then, place another end with the IR blaster close to the TV sensor. For information, check the user manual of your TV.



4 Use your Sound Bar system

Use your Sound Bar with the top panel or remote control

- 1 Make sure the Sound Bar is properly connected to the power supply and sources.
- 2 Press  on the top panel of your Sound Bar main unit or remote control to power on the Sound Bar.
- 3 Press  at the top panel of your Sound Bar main unit or remote control to switch to the correct source.

LED behaviors under different source modes

LED indicators	Source mode
The red LED is on solidly.	in standby mode
The purple LED is on solidly.	in HDMI ARC mode
The green LED is on solidly.	in AUX mode
The blue LED is on solidly.	in Bluetooth mode
The blue LED flashes slowly.	ready to pair
The blue LED flashes slowly.	pairing in progress

The yellow LED is on solidly. in optical mode



The white LED is on solidly. in USB mode

Tip

- You can use more advanced functions on the remote control (see 'Overview of the remote control' on page 14).

Sound settings

You can enjoy your movies or music with your ideal sound.

- Press **+/-** to adjust the volume.
- Press  on the remote control to mute the sound. Press  again to unmute the sound.
- Press the **EQ** buttons (**NEWS/MOVIE/MUSIC**) on the remote control to select the equalizer (EQ) effect when you are watching **news** or **movies** or listening to **music**.

Operation	LED indicators
Adjust the volume.	The white LED flashes quickly and goes back to the source LED.
Mute the Sound Bar.	The red LED keeps flashing.
Unmute the Sound Bar.	The red LED flashes and goes back to the source LED.

Maximum or minimum volume level is reached.	The red LED is on for 2 seconds and goes back to the source LED.
Select the equalizer (EQ effect).	Movie: The white LED flashes once. Music: The green LED flashes once. News: The yellow LED flashes once.

Control the Sound Bar with your TCL Roku TV remote control

Turn on the Sound Bar

When the sound bar is in standby mode, pressing the volume up (+) button of your TCL Roku TV remote control will turn on the Sound Bar.

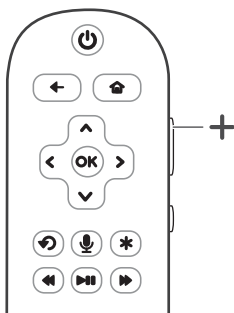

Control the Sound Bar volume

When the sound bar is on, pressing the volume up or down button of your TCL Roku TV remote control will turn the Sound Bar volume up (+) or down (-).

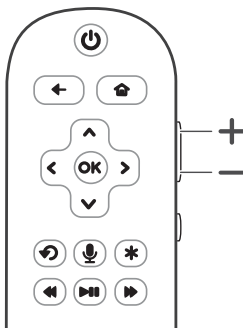





Listen to music from your Bluetooth device

- 1 Make sure that your device supports A2DP and/or AVRCP. For information, check the specification of your device.
- 2 Pair your Bluetooth device with the Sound Bar main unit (see 'Connect the Sound Bar with your Bluetooth device' on page 24).
- 3 Start listening to music stored in your Bluetooth device through the Sound Bar.
 - If your Bluetooth device supports A2DP, you can listen to music, but you cannot control the playback.
 - If your Bluetooth device supports AVRCP, you can listen to music and control music playback with the remote control. Press ►|| to pause or resume music playback. Press ◀/▶ to skip to the previous/next track.

Note

- The operational range between the Sound Bar main unit and your Bluetooth device is approximately 10 meters (without any obstacle between the Bluetooth device and Sound Bar main unit).

Use the USB cable or device for music playback

- 1 Connect the USB device to the USB Type A connector on your Sound Bar main unit.
- 2 Press  on the Sound Bar main unit or remote control until the white LED is on.
- 3 You can now listen to music through the Sound Bar.
 - To pause or resume music, press  on the remote control.
 - To skip to the previous or next track, press  or  on the remote control.

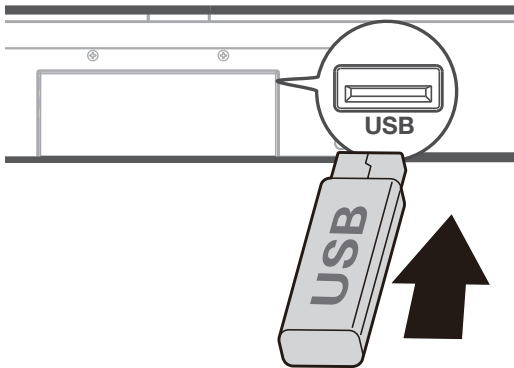

Operation	LED indicators
Listen to music.	The white LED is on.
Press ▶II to pause the music.	The white LED keeps flashing.
Press ◀ or ▶ to skip to the previous/next track	The white LED flashes quickly and goes back to the source LED.

Tip

- This Sound Bar can support USB devices of up to 32GB memory and the supported file formats are MP3, WAV, FLAC.

5 Specifications

Sound Bar main unit

- Power adapter: AC~100-240V, 50/60Hz
- Power consumption: 25W
- Power consumption at standby mode: $\leq 0.5W$
- Impedance: 6Ω
- Frequency response: 150 Hz-20 kHz
- Dimensions (W x D x H): 920 x 98 x 64 mm
- Weight: 2.56 kg
- Operating temperature: $0^{\circ}C - 45^{\circ}C$

Bluetooth

- Bluetooth version: 4.2, Bluetooth profile - Bluetooth stereo supported (Advanced Audio Distribution Profile - A2DP; Audio Video Remote Control Profile - AVRCP)
- Frequency range: 2402 Mhz – 2480 Mhz
- Max transmitting power: 3.587dBm

Remote control

- Distance/Angle: 6m/ 30°
- Battery type: 1.5V AAA battery x 2, user replaceable.

6 Notice

Compliance notice

Notice for US

FCC Information

Warning

- *Changes or modifications to this unit not expressly approved by the party responsible for compliance could void the user's authority to operate the equipment.*

Note

- This equipment has been tested and found to comply with the limits for a Class B digital device, pursuant to Part 15 of the FCC Rules. These limits are designed to provide reasonable protection against harmful interference in a residential installation. This equipment generates, uses and can radiate radio frequency energy and, if not installed and used in accordance with the instructions, may cause harmful interference to radio communications. However, there is no guarantee that interference will not occur in a particular installation.

If this equipment does cause harmful interference to radio or television reception, which can be determined by turning the equipment off and on, the user is encouraged to try to correct the interference by one or more of the following measures:

- Reorient or relocate the receiving antenna.
- Increase the separation between the equipment and receiver.
- Connect the equipment into an outlet on a circuit different from that to which the receiver is connected.
- Consult the dealer or an experienced radio / TV technician for help.

To assure continued compliance, any changes or modifications not expressly approved by the party responsible for compliance could void the user's authority to operate this equipment. (Example- use only shielded interface cables when connecting to computer or peripheral devices).

This set complies with the FCC rules Part 15 . Operation is subject to the following two conditions:

- 1 This device may not cause harmful interference, and
- 2 This device must accept any interference received, including interference that may cause undesired operation.

FCC Radiation Exposure Statement: This equipment complies with FCC radiation exposure limits set forth for an uncontrolled environment. This equipment should be installed and operated with a minimum distance of 20cm

between the radiator and your body. This transmitter must not be co-located or operated in conjunction with any other antenna or transmitter.

WARNING: Changes or modifications made to this equipment not expressly approved by TCL Corporation may void the FCC authorization to operate this equipment.

Caution

- The manufacturer is not responsible for any radio or TV interference caused by unauthorized modifications to this equipment. Such modifications could void the user authority to operate the equipment.

Notice for Canada

Class B Clause

This digital apparatus does not exceed the Class B limits for radio noise emissions from digital apparatus as set out in the Radio Interference Regulations of the Canadian Department of Communications.

This Class B digital apparatus complies with Canadian ICES-003

This device complies with Industry Canada licence-exempt RSS standard(s). Operation is subject to the following two conditions: (1) this device may not cause

harmful interference, and (2) this device must accept any interference received, including interference that may cause undesired operation.

CAN ICES-3(B)/NMB-3(B)

IC Radiation Exposure Statement

This equipment complies with Canada radiation exposure limits set forth for uncontrolled environments.

This transmitter must not be co-located or operating in conjunction with any other antenna or transmitter.

Caution: The user is cautioned that changes or modifications not expressly approved by the party responsible for compliance could void the user's authority to operate the equipment.

Disposal of your old product and battery

Your product is designed and manufactured with high quality materials and components, which can be recycled and reused.

This product may contain lead and mercury. Disposal of these materials may be regulated due to environmental considerations. For disposal or recycling information, please contact your local authorities.

This product contains non-removable batteries:

- Do not incinerate. Batteries may explode if overheated.
- For disposal or recycling information, please contact your local authorities.

Trademarks

Bluetooth



The Bluetooth® word mark and logos are registered trademarks owned by Bluetooth SIG, Inc. and any use of such marks by TCL Corporation under license. Other trademarks and trade names are those of their respective owners.

Dolby Audio



Manufactured under license from Dolby Laboratories. Dolby, Dolby Audio, and the double-D symbol are trademarks of Dolby Laboratories. Copyright 1992-2015 Dolby Laboratories. All rights reserved.

HDMI



HDMI, and HDMI logo and High-Definition Multimedia Interface are trademarks or registered trademarks of HDMI licensing LLC.

7 FAQ

No power

- Make sure the AC power cord and AC input connector are connected properly.
- Make sure there is power supply.
- Make sure the Sound Bar has turned on.

No sound

- Make sure the audio cable is connected to the Sound Bar and your device.
- Make sure you have selected the correct source.
- Press **+** to increase the volume level.
- Make sure the Sound Bar is not muted.

The remote control does not work.

- Make sure you have selected the correct source.
- Make sure the distance of remote control and the Sound Bar main unit is within operational range.
- Make sure the battery is correctly inserted and is working.
- Make sure the remote control is close to the remote control sensor of the Sound Bar main unit.

I hear distorted sound.

- Make sure all cables are properly connected.
- Make sure you have selected the correct source.
- Make sure the TV is muted if you play audio from the TV.

I cannot find the Bluetooth name of this Sound Bar on my Bluetooth device.

- Make sure the Bluetooth function is activated on your Bluetooth device.
- Make sure the Sound Bar has paired with your Bluetooth device.

For further support, visit

www.tclusa.com/support or www.tclcanada.com/support

DO NOT RETURN TO STORE

**WE ARE
READY TO
HELP** contact us first
with any questions



TCL SUPPORT:
www.tclusa.com/support or
www.tclcanada.com/support
1-877-300-9223



**TAKE CARE WHEN
REMOVING THE SOUNDBAR**