

TCL

TV SOUNDBAR

Instruction Manual





TS5010

Contents

Important Safety Instructions	1
Safety	1
Warning	2
What's in the Box	4
Specifications	4
Identifying the Parts	5
Main Unit	5
Wireless Subwoofer.....	6
Remote Control	6
Preparations	6
Prepare the Remote Control.....	6
Replace the Remote Control Battery	7
Placement and Mounting	7
Connections	8
IR (TV's Control Sensor) Socket.....	8
Use the OPTICAL Socket.....	8
Use the AUX Socket.....	9
Connect to Power	9
Pairing the Wireless Subwoofer with the Main Unit.....	9
Automatic pairing.....	9
Manual pairing.....	9
Basic Operation	10
Standby/ON	10
Select Modes	10
Adjust the Volume	10
Select equalizer (EQ) Effect	10
AUX/OPTICAL Operation	11
Bluetooth Operation.....	11
Pair Bluetooth-enabled Devices.....	11
Listen to Music from Bluetooth Device	12
USB Operation	12
Troubleshooting.....	13

Important Safety Instructions

	CAUTION RISK OF ELECTRIC SHOCK DO NOT OPEN	
CAUTION: TO REDUCE THE RISK OF ELECTRIC SHOCK, DO NOT REMOVE COVER (OR BACK). NO USER-SERVICEABLE PARTS INSIDE. REFER SERVICING TO QUALIFIED SERVICE PERSONNEL.		





The lightning flash with arrowhead symbol, within an equilateral triangle, is intended to alert the user to the presence of uninsulated "dangerous voltage" within the product's enclosure that may be of sufficient magnitude as to constitute a risk of electric shock to persons.



The exclamation point within an equilateral triangle is intended to alert the user to the presence of important operating and maintenance (servicing) instructions in the literature accompanying the appliance.

Safety

- 1 Read these instructions** – All the safety and operating instructions should be read before this product is operated.
- 2 Keep these instructions** – The safety and operating instructions should be retained for future reference.
- 3 Heed all warnings** – All warnings on the appliance and in the operating instructions should be adhered to.
- 4 Follow all instructions** – All operating and usage instructions should be followed.
- 5 Do not use this apparatus near water** – The appliance should not be used near water or moisture – for example, in a wet basement or near a swimming pool and the like.
- 6 Clean only with a dry cloth.**
- 7 Do not block any ventilation openings.** Install in accordance with the manufacturer's instructions.
- 8 Do not install near any heat sources** such as radiators, heaters, stoves, or other apparatus (including amplifiers) that produce heat.
- 9 Do not defeat the safety purpose of the polarized or grounding plug.** A polarized plug has two blades with one wider than the other. A grounding plug has two blades and a third grounding prong. The wide blade or the third prong is provided for your safety. If the provided plug does not fit into your outlet, consult an electrician for replacement of the obsolete outlet.
- 10 Protect the power cord from being walked on or pinched particularly at plugs, convenience receptacles, and the point where they exit from the apparatus.**
- 11 Only use attachments/accessories specified by the manufacturer.**
- 12**  Use only with the cart, stand, tripod, bracket or table specified by the manufacturer, or sold with the apparatus. When a cart or rack is used, use caution when moving the cart/apparatus combination to avoid injury from tip-over.
- 13 Unplug the apparatus during lightning storms or when unused for long periods of time.**
- 14 Refer all servicing to qualified personnel.** Servicing is required when the apparatus has been damaged in any way, such as power supply cord or plug is damaged, liquid has been spilled or objects have fallen into the apparatus, the unit has been exposed to rain or moisture, does not operate normally, or has been dropped.
- 15**  This equipment is a Class II or double insulated electrical appliance. It has been designed in such a way that it does not require a safety connection to electrical earth.
- 16 The apparatus shall not be exposed to dripping or splashing.** No objects filled with liquids, such as vases, shall be placed on the apparatus.
- 17 Minimum distance around the apparatus for sufficient ventilation is 5cm.**
- 18 The ventilation should not be impeded by covering the ventilation openings with items, such as newspapers, table-cloths, curtains, etc...**
- 19 No naked flame sources, such as lighted candles, should be placed on the apparatus.**
- 20 Batteries should be recycled or disposed of as per state and local guidelines.**
- 21 The use of apparatus in moderate climates.**

• **Caution:**

- Use of controls or adjustments or performance of procedures other than those described herein, may result in hazardous radiation exposure or other unsafe operation.
- To reduce the risk of fire or electric shock, do not expose this apparatus to rain or moisture. The apparatus must not be exposed to dripping or splashing and objects filled with liquids, such as vases, must not be placed on apparatus.
- The mains plug/appliance coupler is used as the disconnect device, the disconnect device must remain readily operable.
- Danger of explosion if battery is incorrectly replaced. Replace only with the same or equivalent type.

Warning

- The battery (batteries or battery pack) shall not be exposed to excessive heat such as sunshine, fire or the like.
- Before operating this system, check the voltage of this system to see if it is identical to the voltage of your local power supply.
- Do not place this unit close to strong magnetic fields.
- Do not place this unit on the amplifier or receiver.
- Do not place this unit close to damp areas as the moisture will affect the life of the laser head.
- If any solid object or liquid falls into the system, unplug the system and have it checked by qualified personnel before operating it any further.
- Do not attempt to clean the unit with chemical solvents as this may damage the finish. Use a clean, dry or slightly damp cloth.
- When removing the power plug from the wall outlet, always pull directly on the plug, never yank on the cord.
- Changes or modifications to this unit not expressly approved by the party responsible for compliance will void the user's authority to operate the equipment.
- The rating label is pasted on the bottom or back of the equipment.

⚠ DO NOT INGEST BATTERY, CHEMICAL BURN HAZARD

The remote control supplied with this product contains a coin/button cell battery. If the coin/button cell battery is swallowed, it can cause severe internal burns in just 2 hours and lead to death. Keep new and used batteries away from children. If the battery compartment does not close securely, stop using the product and keep it away from children. If you think batteries might have been swallowed or placed inside any part of the body, seek immediate medical attention.



Correct Disposal of this product. This marking indicates that this product should not be disposed with other household wastes throughout the EU. To prevent possible harm to the environment or human health from uncontrolled waste disposal, recycle it responsibly to promote the sustainable reuse of material resources. To return your used device, please use the return and collection systems or contact the retailer where the product was purchased. They can take this product for environmental safe recycling.



The Bluetooth® word mark and logos are registered trademarks owned by Bluetooth SIG, Inc. We are the licensee to use such marks. Other trademarks and trade names are those of their respective owners.

For U.S. models

FCC Information

Warning:

Changes or modifications to this unit not expressly approved by the party responsible for compliance could void the user's authority to operate the equipment."

NOTE:

- This equipment has been tested and found to comply with the limits for a Class B digital device, pursuant to Part 15 of the FCC Rules. These limits are designed to provide reasonable protection against harmful interference in a residential installation. This equipment generates, uses and can radiate radio frequency energy and, if not installed and used in accordance with the instructions, may cause harmful interference to radio communications.
- However, there is no guarantee that interference will not occur in a particular installation. If this equipment does cause harmful interference to radio or television reception, which can be determined by turning the equipment off and on, the user is encouraged to try to correct the interference by one or more of the following measures:
 - Reorient or relocate the receiving antenna.
 - Increase the separation between the equipment and receiver.
 - Connect the equipment into an outlet on a circuit different from that to which the receiver is connected.
 - Consult the dealer or an experienced radio / TV technician for help.
- This device complies with Part 15 of the FCC Rules. Operation is subject to the following two conditions:
 - (1) this device may not cause harmful interference, and
 - (2) this device must accept any interference received, including interference that may cause undesired operation.

"FCC RF Radiation Exposure Statement Caution: To maintain compliance with the FCC's RF exposure guidelines, place the product at least 20cm from nearby persons."

What's in the Box



Main Unit

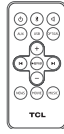

Remote Control



Wireless Subwoofer

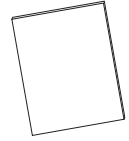

User Manual

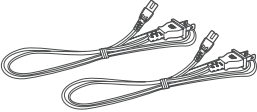

AC Power Cord



3.5mm audio Cable



2.5mm TV's remote control receiving extension Cable



Wall Bracket/Silicone pad



Optical Cable



Wall mounting Screw

Specifications

Soundbar

Power Supply	AC 100-240V~ 50/60Hz
Power Consumption	25W / < 0.5 W (Standby)
USB	5V --- 500mA
Dimension (W x D x H)	800 x 65 x 86 mm
Audio input sensitivity	500mV
Frequency Response	120Hz - 20KHz
Impedance	8 Ω

Bluetooth

Version	V 4.2
Maximum power transmitted	5 dBm
Frequency bands	2402 MHz ~ 2480 MHz

2.4G

Frequency Response	40Hz - 120Hz
Maximum power transmitted	-7dBm
Frequency bands	2400 MHz ~ 2483 MHz

Remote Control

Distance/Angle	6m / 30°
Battery type	CR 2025

- Design and specifications are subject to change without notice.

Identifying the Parts

Main Unit

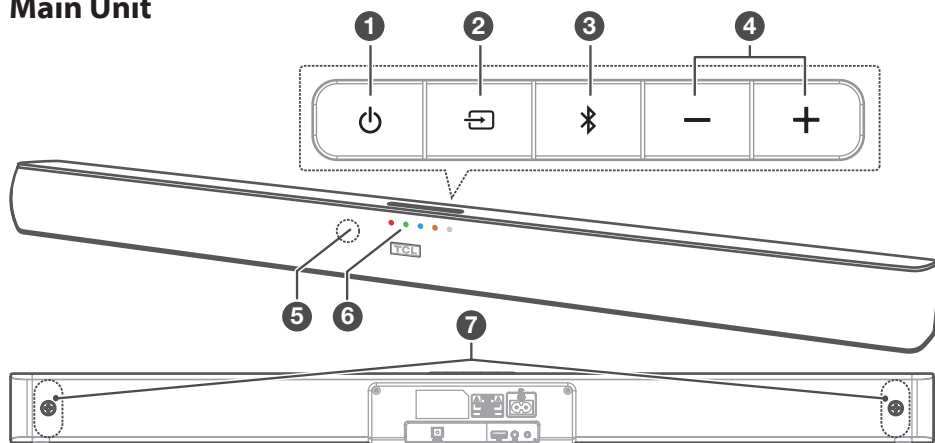

- 1** **button**
Switch the unit between ON and STANDBY mode.
- 2** **(SOURCE) button**
Select the play function.
- 3** **(Bluetooth) button**
Select the Bluetooth mode.
Press and hold to activate the pairing function in Bluetooth mode or disconnect the existing paired Bluetooth device.
- 4** **VOL+ /VOL- buttons**
Increase/decrease the volume level.
- 5** **Remote Control Sensor**
Receive the signal from the remote control.
- 6** **LED Indicators**
 - Red indicator: In STANDBY mode.
 - Green indicator: In AUX mode.
 - Blue indicator: In Bluetooth mode.
 - Orange indicator: In Optical mode.
 - White indicator: In USB mode.
- 7** **Wall bracket screws**

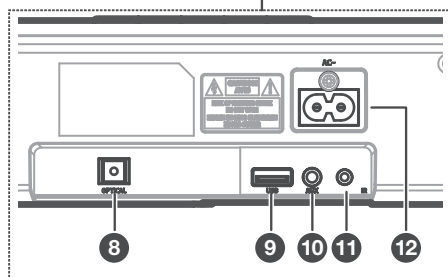

- 8** **OPTICAL Socket**
Optical input jack.
- 9** **USB Socket**
Insert the USB device to play music.
- 10** **AUX Socket**
Connect to an external audio device.
- 11** **IR (TV's Control Sensor) Socket**
Connect the 2.5mm TV's remote control receiving extension Cable.
- 12** **AC~ Socket**
Connect power cord.

Wireless Subwoofer

- 1 AC~ Socket**
Connect to power.
- 2 PAIR button**
Press activate the pairing function between the main unit and the Subwoofer.
- 3 PAIR Indicator**
Light up solidly when the pairing succeed.

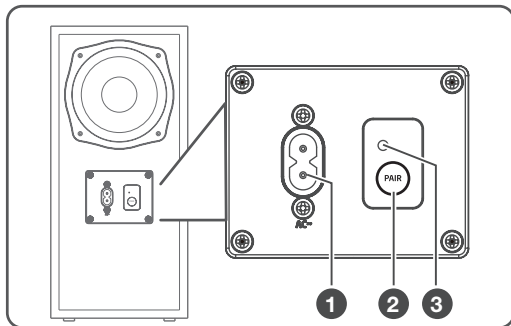

Remote Control

- 1** Switch the unit between ON and STANDBY mode.
- 2 MUTE**
Mute or resume the sound.
- 3 Source buttons**
Select the play function.
- 4 VOL+/VOL-**
Increase/decrease the volume level.
- 5** Skip to previous/next track in Bluetooth/USB mode.
- 6** **PAIR**
Play/pause/resume playback in Bluetooth/USB mode. Press and hold to activate the pairing function in Bluetooth mode or disconnect the existing paired Bluetooth device.
- 7 EQ buttons**
Select equalizer (EQ) Effect.

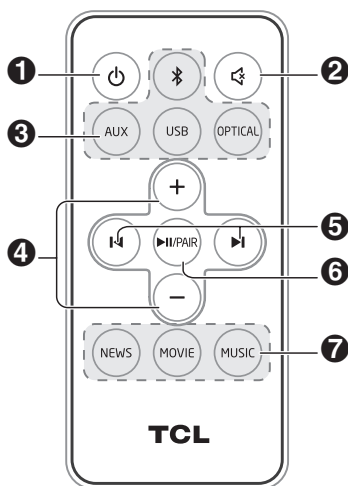

Preparations

Prepare the Remote Control

The provided Remote Control allows the unit to be operated from a distance.

- Even if the Remote Control is operated within the effective range 19.7 feet (6m), remote control operation may be impossible if there are any obstacles between the unit and the remote control.
- If the Remote Control is operated near other products which generate infrared rays, or if other remote control devices using infra-red rays are used near the unit, it may operate incorrectly. Conversely, the other products may operate incorrectly.

• First-time use:

The unit has a pre-installed lithium CR2025 battery. Remove the protective tab to activate the remote control battery.

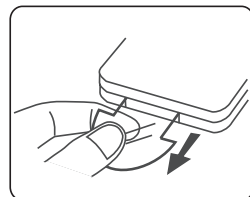

Replace the Remote Control Battery

- The remote control requires a CR2025, 3V Lithium battery.
- 1. Push the tab on the side of the battery tray towards the tray.
- 2. Now slide the battery tray out of the remote control.
- 3. Remove the old battery. Place a new CR2025 battery into the battery tray with the correct polarity (+/-) as indicated.
- 4. Slide the battery tray back into the slot in the remote control.

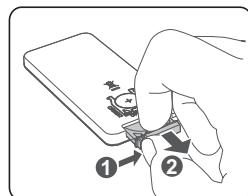

• Precautions Concerning Batteries

- When the Remote Control is not to be used for a long time (more than a month), remove the battery from the Remote Control to prevent it from leaking.
- If the batteries leak, wipe away the leakage inside the battery compartment and replace the batteries with new ones.
- Do not use any batteries other than those specified.
- Do not heat or disassemble batteries.
- Never throw them in fire or water.
- Do not carry or store batteries with other metallic objects. Doing so could cause batteries to short circuit, leak or explode.
- Never recharge a battery unless it is confirmed to be a rechargeable type.

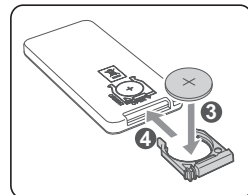

Placement and Mounting

- **Normal Placement (place Soundbar on leveled surface in front of TV)**



Wall Mounting (if using option-B)

Note:

- Installation must be carried out by qualified personnel only. Incorrect assembly can result in severe personal injury and property damage (if you intend to install this product yourself, you must check for installations such as electrical wiring and plumbing that may be buried inside the wall). It is the installer's responsibility to verify that the wall will safely support the total load of the unit and wall brackets.
 - Additional tools (not included) are required for the installation.
 - Do not overtighten screws.
 - Keep this instruction manual for future reference.
 - Use an electronic stud finder to check the wall type before drilling and mounting.
1. Drill 4 parallel holes (\varnothing 5.5-6 mm each according to wall type) in the wall. The distance between the holes should be **735 mm**.
 2. Firmly fix 1 dowel into each hole in the wall if necessary. Tighten the wall mount brackets on the wall with screws and screwdriver (not included). Make sure that they are securely installed.
- If necessary, stick the Silicone pad into the brackets to balance the machine.
3. Remove the screws at the back of the unit. Install the wall mounting screws into the back of the unit.
 4. Lift the unit onto the wall mount brackets and slot into place.

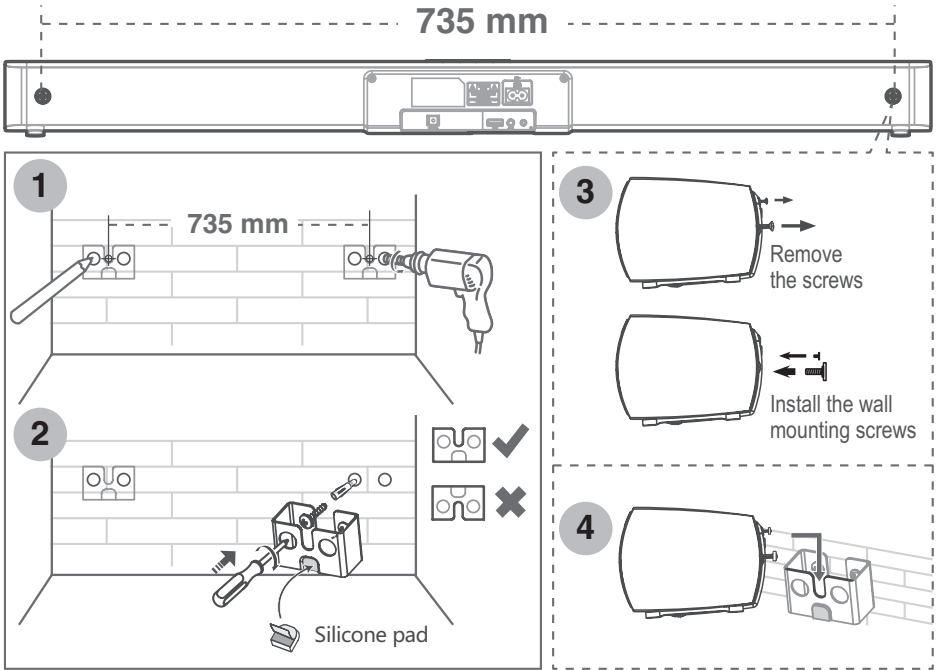

Connections

IR (TV's Control Sensor) Socket

When the Soundbar is placed in front of the TV, it may block the remote control reception of the TV. If you cannot use the TV remote control. You can use the 2.5mm TV's remote control receiving extension cable (included) to connect to the IR jack on the back of the main unit and the other end to the TV remote sensing area.

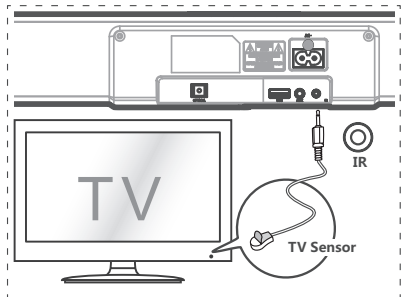

Use the OPTICAL Socket

- Remove the protective cap of the OPTICAL socket, then connect an OPTICAL cable (included) to the TV's OPTICAL OUT socket and the OPTICAL socket on the unit.
- **Tip:** While in **OPTICAL** mode, if there's no sound output from the unit and the **OPTICAL** lights flashes quickly, you may need to activate **PCM** signal output on your source device (eg. TV, DVD or Blu-ray player).

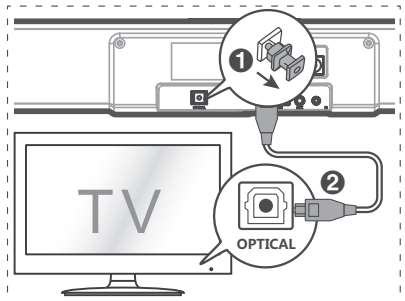

Use the AUX Socket

- A. Use a RCA to 3.5mm audio cable (not included) to connect the TV's audio output sockets to the **AUX** socket on the unit.
- B. Use a 3.5mm to 3.5mm audio cable (included) to connect the TV's or external audio device headphone socket to the **AUX** socket on the unit.

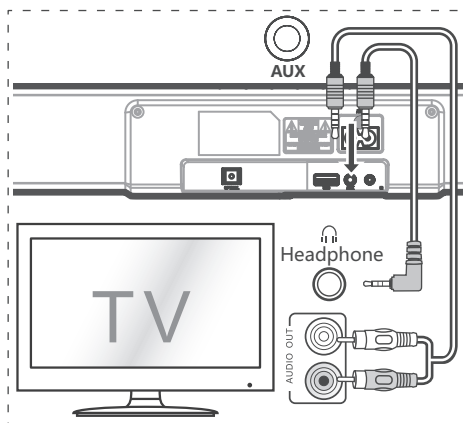

Connect to Power

Risk of product damage!

- Before connecting the AC power cord, ensure you have completed all other connections.
- Ensure that the power supply voltage corresponds to the voltage printed on the back or the underside of the unit.

Soundbar

- Connect the mains cable to the **AC~** Socket of the unit and then into a mains socket.

Subwoofer

- Connect the mains cable to the **AC~** Socket of the subwoofer and then into a mains socket.

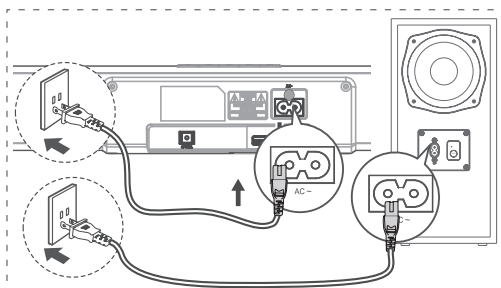

Pairing the Wireless Subwoofer with the Main Unit

Automatic pairing

The subwoofer and soundbar will automatically pair when both units are plugged into the mains sockets and turned on. No cable is needed for connecting the two units.

- When the subwoofer is pairing with the main unit, the Pair Indicator will flash fash.
- When the subwoofer is paired with the main unit, the Pair Indicator will light up.

NOTE:

- Do not press the **Pair** button on the rear of the subwoofer, except for manual pairing.
- If the automatic pairing fails, pair the subwoofer with the main unit manually.

Manual pairing

1. Ensure that all the cables are well connected and the main unit is in Standby mode.
2. Press and hold the **Pair** button on the rear of the subwoofer for a few seconds. The subwoofer will enter the pairing mode and the Pair Indicator will blink quickly.
3. Press the **U** button on the main unit or on the remote control to switch the main unit on.
4. After the wireless connection succeeded, the Pair Indicator will light up.
5. If the **Pair** indicator blinks, the wireless connection has failed. Unplug the cable of the subwoofer and then reconnect the main cable after 3 minutes. Repeat step 1 ~ 4.

NOTE:

- If the wireless connection fails again, check if there is conflict or strong interference (for example, interference from an electronic device) around your location. Remove these conflicts or strong interferences and repeat the above procedures.
- The subwoofer should be within 6m of the soundbar in an open area.
- If a TV or an external device is connected, the main unit and the subwoofer will switch on automatically when the TV or the external device is switched on.
- If the main unit is not connected with the subwoofer and it is in On mode, the POWER Indicator will flash. Follow step 1 ~ 4 above to pair the subwoofer to the main unit.

Basic Operation

Standby/ON

- When you first connect the unit to the main socket, the unit will be in STANDBY mode. The POWER indicator will light up red.
- Press the  button on the remote control to switch the main unit ON or OFF.
- Disconnect the main plug from the main socket if you want to switch the unit off completely.
- If a TV or an external device (Only for AUX socket) is connected, the unit will switch on automatically when the TV or the external device is switched on.
- When the unit has no input signal for over 15 minutes, it will automatically switch to Standby mode.

Select Modes

Press the  (SOURCE) button on the unit repeatedly or press the **AUX, BT** (Bluetooth), **OPTICAL, USB** buttons on the remote control to select the desired mode.

The indicator light on the front of the main unit will show which mode is currently in use.

- Red indicator: In STANDBY mode.
- Green indicator: In AUX mode.
- Blue indicator: In Bluetooth mode.
- Orange indicator: In Optical mode.
- White indicator: USB mode.

Adjust the Volume

- Press the **VOL+** / **VOL-** buttons on the unit or on the remote control to adjust the volume.
- If you wish to turn the sound off, press the **MUTE** button on the remote control. Press the **MUTE** button again or press the **VOL+** / **VOL-** buttons on the unit or on the remote control to resume normal listening.
- **Note:** While adjusting the volume, the status LED indicator will flash quickly. When the volume has hit maximum/minimum value level, the status LED indicator will flashes once.

Select equalizer (EQ) Effect

While playing, press the **NEWS** or **MOVIE** or **MUSIC** buttons on the remote control to select between preset equalizers: **Movie** (recommended for viewing movies), **Music** (recommended for listening to music), **NEWS** (recommended for listening to NEWS).

AUX/OPTICAL Operation

- 1 Ensure that the unit is connected to the TV or audio device.
- 2 While in ON mode, press the  (SOURCE) button on the unit repeatedly or press the **AUX**, **OPTICAL** buttons on the remote control to select the desired mode.
- 3 Operate your audio device directly for playback features.
- 4 Press the **VOL +/-** button to adjust the volume to your desired level.

Tip:



- While in **OPTICAL** mode, if there's no sound output from the unit and the **OPTICAL** lights flashes quickly, you may need to activate **PCM** signal output on your source device (eg. TV, DVD or Blu-ray player).

Bluetooth Operation

Pair Bluetooth-enabled Devices

The first time you connect your Bluetooth device to this player, you need to pair your device to this player.

Note:

- The operational range between this player and a Bluetooth device is approximately 8 meters (without any object between the Bluetooth device and the unit).
 - Before you connect a Bluetooth device to this unit, ensure you know the device's capabilities.
 - Compatibility with all Bluetooth devices is not guaranteed.
 - Any obstacle between this unit and a Bluetooth device can reduce the operational range.
 - If the signal strength is weak, your Bluetooth receiver may disconnect, but it will re-enter pairing mode automatically.
- 1 While in ON mode, press the  button on the remote control or on the unit to select Bluetooth mode. The **Blue** indicator will light flash.
 - 2 Activate your Bluetooth device and select the search mode. "**TS5010**" will appear on your Bluetooth device list.
 - If you cannot find the unit, press and hold the "" button on the unit or press the **▶ II/PAIR** button on the remote control to be searchable. After the "**Pairing**" voice prompt and the Blue indicator will flash rapidly.
 - 3 Select "**TS5010**" in the pairing list. After the "**Paired**" voice prompt, the system is successfully connected and the Blue indicator will light up solidly.
 - 4 Begin playing music from the connected Bluetooth device.

To disconnect the Bluetooth function, you can :

- Switch to another function on the unit.
- Disable the Bluetooth function on your device. The device is successfully disconnected from the unit after the "**Disconnected**" voice prompt.
- Press and hold the "" button on the unit or press the **▶ II/PAIR** button on the remote control.

Tips:

- Enter "0000" for the password if necessary.
- If no other Bluetooth device pairs with this player in 2 minutes, the player will reconnect to the previous connection.
- The player will also be disconnected when your device is moved beyond the operational range.
- If you want to reconnect your device to this player, place it within the operational range.

- If the device is moved beyond the operational range, when it is brought back, please check if the device is still connected to the player.
- If the connection is lost, follow the instructions above to pair your device to the player again.

Listen to Music from Bluetooth Device

- If the connected Bluetooth device supports Advanced Audio Distribution Profile (A2DP), you can listen to the music stored on the device through the soundbar'.
- If the device also supports Audio Video Remote Control Profile (AVRCP), you can use the soundbar's remote control to play music stored on the device.
 1. Pair your device with the player.
 2. Play music via your device (if it supports A2DP).
 3. Use supplied remote control to control play (if it supports AVRCP).
 - To pause/resume play, press the ► || /PAIR button on the remote control.
 - To skip to a track, press the |◀/▶| buttons on the remote control.

USB Operation

- 1 Insert the USB device.
- 2 Press the  (SOURCE) button repeatedly on the unit or press the **USB** button on the remote control to select **USB** mode.
- 3 During playback:
 - To pause or resume play, press the ► || /PAIR button on the remote control.
 - To skip to the previous/next file, press the |◀/▶| buttons on the remote control.

Tips:

- The unit can support USB devices with up to 32 GB of memory.
- This unit can play MP3, WAV, FLAC.

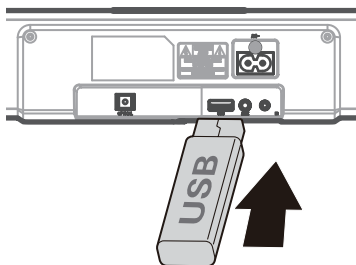

Troubleshooting

To keep the warranty valid, never try to repair the system yourself. If you encounter problems when using this unit, review the following before requesting service.

- **No power**

Ensure that the AC cord is properly connected.

Ensure that there is power at the AC outlet.

Press ⏻ (standby) button on the remote control or soundbar to turn the soundbar on.

- **No sound**

Increase the volume. Press Volume Up on the remote control or on the soundbar.

Press MUTE on the remote control to ensure the soundbar is not muted.

Press source buttons to select a different input source.

When using either of the Digital input, if there is no audio:

- Try setting the TV output to PCM or

- Connect directly to your Blu-ray/other source, some TVs do not pass through digital audio.

Your TV may be set to variable audio output. Confirm that the audio output setting is set to FIXED or STANDARD, not VARIABLE. Consult your TV's user manual for more detailed information.

If using Bluetooth, ensure that the volume on your source device is turned up and that the device is not muted.

- **Remote control does not work**

Before you press any playback control button, first select the correct source.

Reduce the distance between the remote control and the unit.

Insert the battery with its polarities (+/-) aligned as indicated.

Replace the battery.

Aim the remote control directly at the sensor on the front of the unit.

- **I hear buzzing or humming**

Ensure all cables and wires are securely connected.

Connect a different source device (TV, Blu-ray player, etc) to see if the buzzing persists. If it does not, the problem may be with the original device.

Connect your device to a different input on the soundbar.

- **I can't find the Bluetooth name of this unit on my Bluetooth device**

Ensure the Bluetooth function is activated on your Bluetooth device.

Re-pair the unit with your Bluetooth device.

- **This is a 15 mins power off function, one of the ERPII standard requirement for saving power**

When the unit's external input signal level is too low, the unit will be turned off automatically in 15 minutes. Please increase the volume level of your external device.

- **The subwoofer is idle or the indicator of subwoofer do not light up**

- Please unplug power cord from the mains socket, and plug it in again after 4 minutes to reset the subwoofer.

TCL SUN INC.

4nd floor ZEN Tower building,
1111 Natividad A. Lopez st., Ermita,
Manila.1000

Tel 0063 2 567 0705

www.tcl.com